

iDOL

CERRAHİ ALETLER
SANAYİ VE TİCARET A.Ş.



ORTOPEDİ
ORTHOPEDIA
ORTHOPÄDIE

ORTOPEDİ
ORTHOPEDIA
ORTHOPÄDIE

ORTHOPÄDIE
ORTHOPEDIA
ORTOPEDİ

ORTHOPEDIA
ORTHOPÄDIE
ORTOPEDİ

Aspratör Ucu
Suction Tube
Saugkanülen



Ø mm	11 cm/4¼"	13 cm/5"	16 cm/6¼"	20 cm/8"
ø 1,5 mm	AS-100-04	AS-101-04	AS-102-04	AS-103-04
ø 2,0 mm	AS-100-06	AS-101-06	AS-102-06	AS-103-06
ø 2,5 mm	AS-100-08	AS-101-08	AS-102-08	AS-103-08
ø 3,0 mm	AS-100-10	AS-101-10	AS-102-10	AS-103-10
ø 4,0 mm	AS-100-12	AS-101-12	AS-102-12	AS-103-12
ø 5,0 mm	AS-100-15	AS-101-15	AS-102-15	AS-103-15

Ø mm	90°
2,0	AS-120-20
2,5	AS-120-25
3,0	AS-120-30
3,5	AS-120-35
4,0	AS-120-40
5,0	AS-120-50

FERGUSSON

FRAZIER
19 cm/7½"

Ø mm	
ø 1,5 mm	AS-200-15
ø 2,0 mm	AS-200-20
ø 2,5 mm	AS-200-25
ø 3,0 mm	AS-200-30

PLESTER
19 cm/7½"

ø mm	
2,0	AS-201-02
3,0	AS-201-03
4,0	AS-201-04
5,0	AS-201-05

FRAZIER
13 cm/5"FERGUSSON
AS-250-12
18 cm/7"

Aspratör Ucu
Suction Tube
Saugkanülen

iDOL
CERRAHİ ALETLER
www.idolcerrahi.com



**Dermatom Bıçakları
Skin Grafting Knives
Handdermatome**



BS-162-02

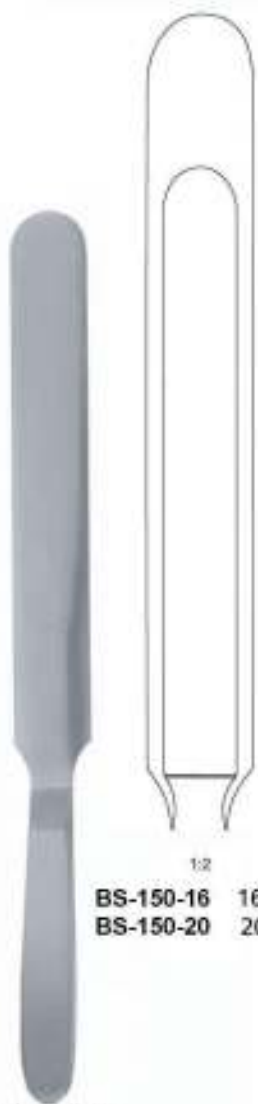

1/2
BS-150-16 16 cm/6¼"
BS-150-20 20 cm/8"

VIRCHOW



BRAITHWAITE
BS-160-30 30 cm/12"



HUMBY
BS-161-36 36 cm/14"



SCHINK
BS-162-30 30 cm/12"

Bisturi Sapları
Scalpel Handles
Skalpelligriffe



BS-200-03
13,5 cm/5¼"
Fig. 3
solid, cm-graduation



BS-200-04
13,5 cm/5¼"
Fig. 4
solid, cm-graduation



BS-201-03
13,5 cm/5¼"
Fig. 3



BS-201-04
13,5 cm/5¼"
Fig. 4



BS-202-13
21,5 cm/8½"
Fig. 3 L



BS-203-14
21 cm/8¼"
Fig. 4 L



BS-210-07
16 cm/6¼"
Fig. 7



BS-211-07
12,5 cm/5"
Fig. 7 K



BS-212-16
14,5 cm/5¾"
Fig. 3 R



BS-213-16
14 cm/5½"
Fig. 3 R

Bisturi Sapları
Scalpel Handles
Skalpellgriffe



BS-220-21
21 cm/8¼"
Fig. 3 L



BS-221-21
21 cm/8¼"
Fig. 4 L



BS-230-16
16 cm/6¼"
No. 5



BS-231-21
21,5 cm/8½"
No. 5



BS-232-21
21 cm/8¼"
No. 5





BS 400-13
13,5 cm/5¼"



BS 400-15
15,5 cm/6"



CASPAR
BS 400-18
18 cm/7"



BS 400-20
20 cm/8"



LANDOLT
BS 410-20
21 cm/8¼"

Spanç ve Temizlik Klempleri
Sponge and Dressing Forceps
Korn und Tupferzangen



CM-200-13 13 cm/5"
 CM-200-16 16 cm/6¼"
 CM-200-18 18 cm/7"

without ratchet

LISTER



with ratchet

ULRICH

22 cm/8¾"	CM-201-22	CM-202-22
25 cm/10"	CM-201-25	CM-202-25



with ratchet

GROSS-MAIER

14 cm/5½"	CM-205-14	CM-206-14
18 cm/7"	CM-205-18	CM-206-18
20 cm/8"	CM-205-20	CM-206-20
22 cm/8¾"	CM-205-22	CM-206-22
25 cm/10"	CM-205-25	CM-206-25
27 cm/10½"	CM-205-27	CM-206-27

Spanç ve Temizlik Klempleri
Sponge and Dressing Forceps
Korn und Tupferzangen



FOERSTER

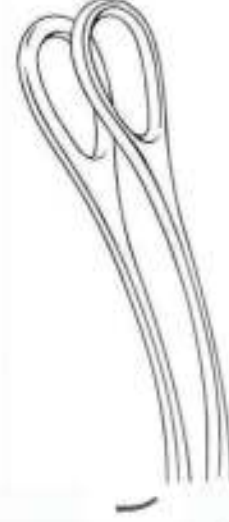
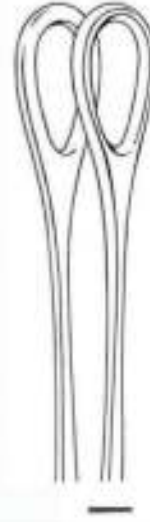

18 cm/7"	CM-223-18	CM-224-18	CM-225-18	CM-226-18
20 cm/8"	CM-223-20	CM-224-20	CM-225-20	CM-226-20
25 cm/10"	CM-223-25	CM-224-25	CM-225-25	CM-226-25



RAMPLEY

CM-229-25
25 cm/10"



SIMS-MAIER
CM-230-28 28 cm/11"

CM-231-28 28 cm/11"

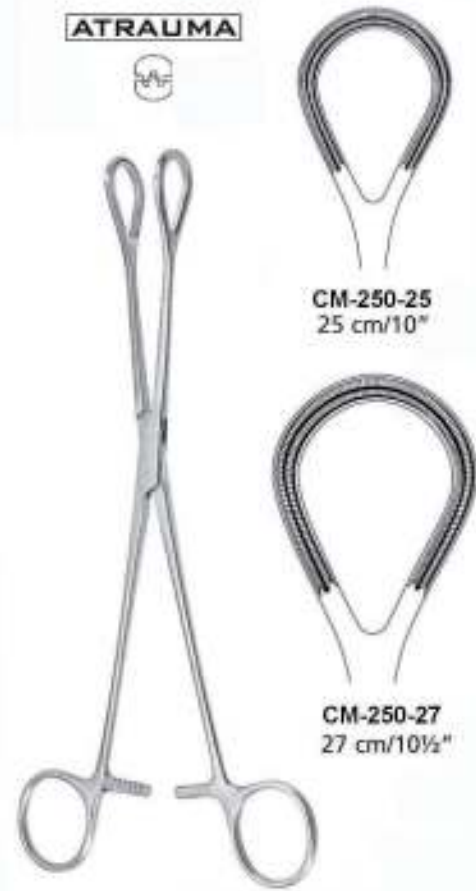

ATRAUMA



CM-250-25
25 cm/10"

CM-250-27
27 cm/10½"

Ekartörler
Retractors
Wundhaken

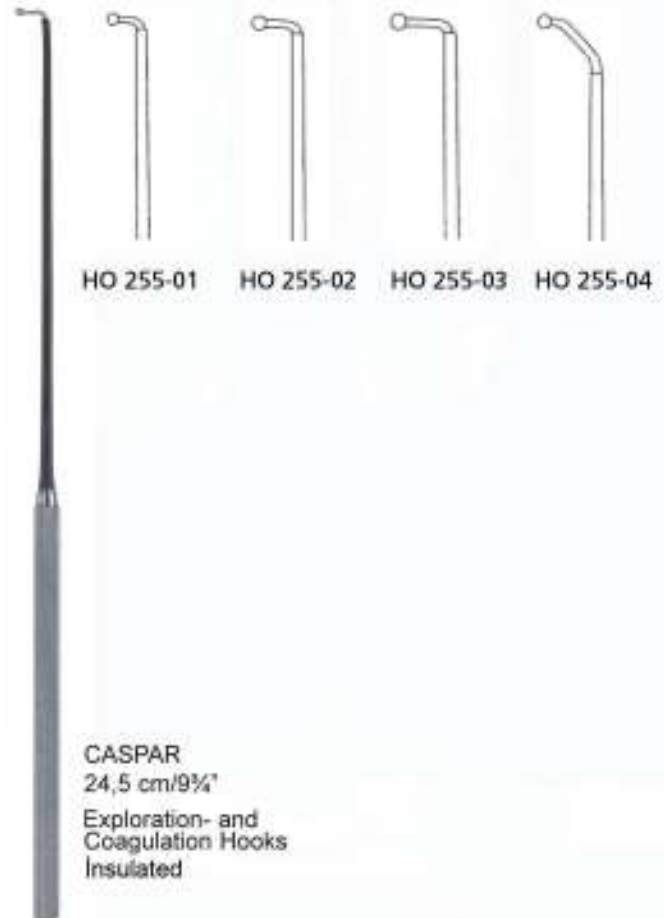
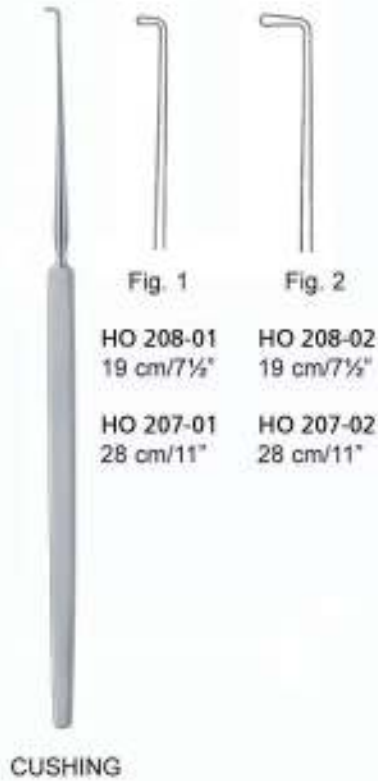

Ekartörler
Retractors
Wundhaken

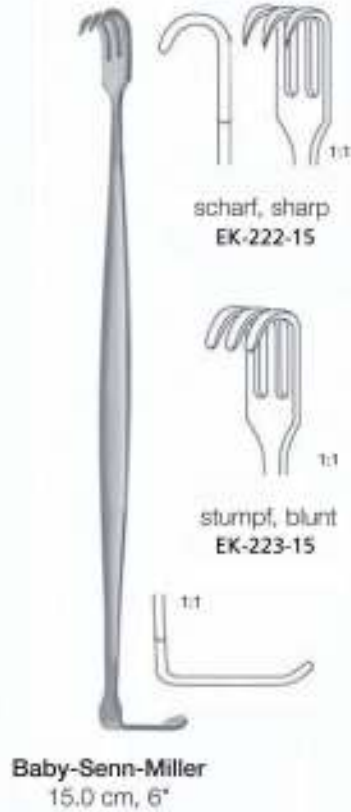

Ekartörler
Retractors
Wundhaken



LOVE
EK-800-21
21 cm/8¼"



CASPAR
24 cm/9½"
6 mm EK-801-06
8 mm EK-801-08
10 mm EK-801-10



O'CONNELL
KB-364-22
22 cm/8¾"



LOVE
EK-802-01
19 cm/7½"



LOVE
EK-802-02
19 cm/7½"



LOVE
EK-802-03
19 cm/7½"



1/2
LANGENBECK
MANNERFELT modif.
15,5 cm/6 1/4"



1/2
MANNERFELT modif.
15,5 cm/6 1/4"



1/2



1/2



1/2

Ekartörler
Retractors
Wundhaken



ROUX
EK-396-00

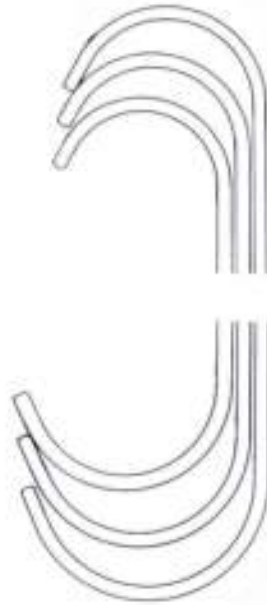

Fig. 1	14 cm/5½"	EK-396-01	24 x 20 / 30 x 28 mm
Fig. 2	15 cm/6"	EK-396-02	29 x 26 / 36 x 36 mm
Fig. 3	17 cm/6¾"	EK-396-03	33 x 29 / 38 x 43 mm



ROUX-Mini
EK-398-00
15 cm/6"
8 x 6 mm



FARABEUF
EK-397-00
12 cm/4¾"
Fig. 1 - 2

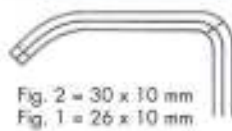

Fig. 2 = 30 x 10 mm
Fig. 1 = 26 x 10 mm

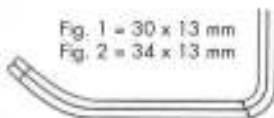

Fig. 1 = 30 x 13 mm
Fig. 2 = 34 x 13 mm



FARABEUF
EK-397-05
15 cm/6"
Fig. 1 - 2

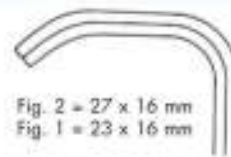

Fig. 2 = 27 x 16 mm
Fig. 1 = 23 x 16 mm

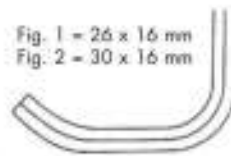

Fig. 1 = 26 x 16 mm
Fig. 2 = 30 x 16 mm



Fig. 2 = 25 x 24 mm
Fig. 1 = 21 x 24 mm

18.131.01
Fig. 1

18.131.02
Fig. 2

Fig. 1 = 40 x 15 mm
Fig. 2 = 45 x 15 mm

US Army (PARKER-LANGENBECK)
EK-401-00
21 cm/8¼"
Fig. 1 - 2



VOLKMANN
21,5 cm/8½"

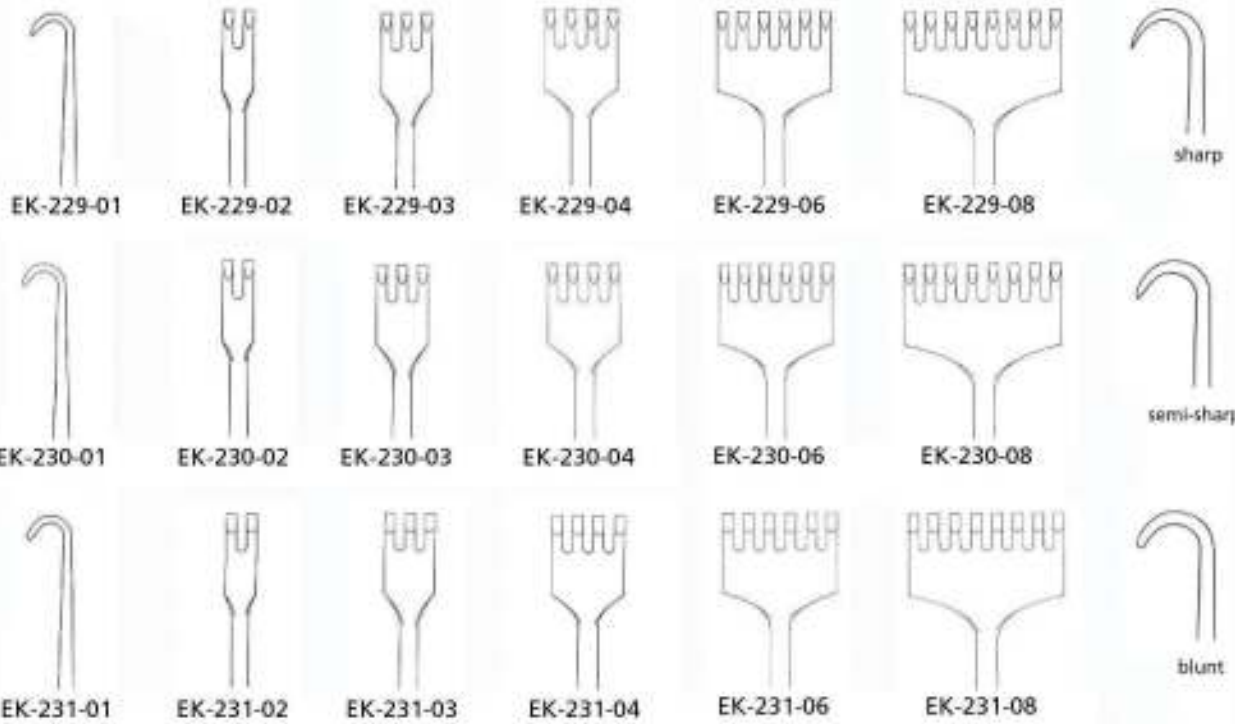

KOCHER
22 cm/8¾"

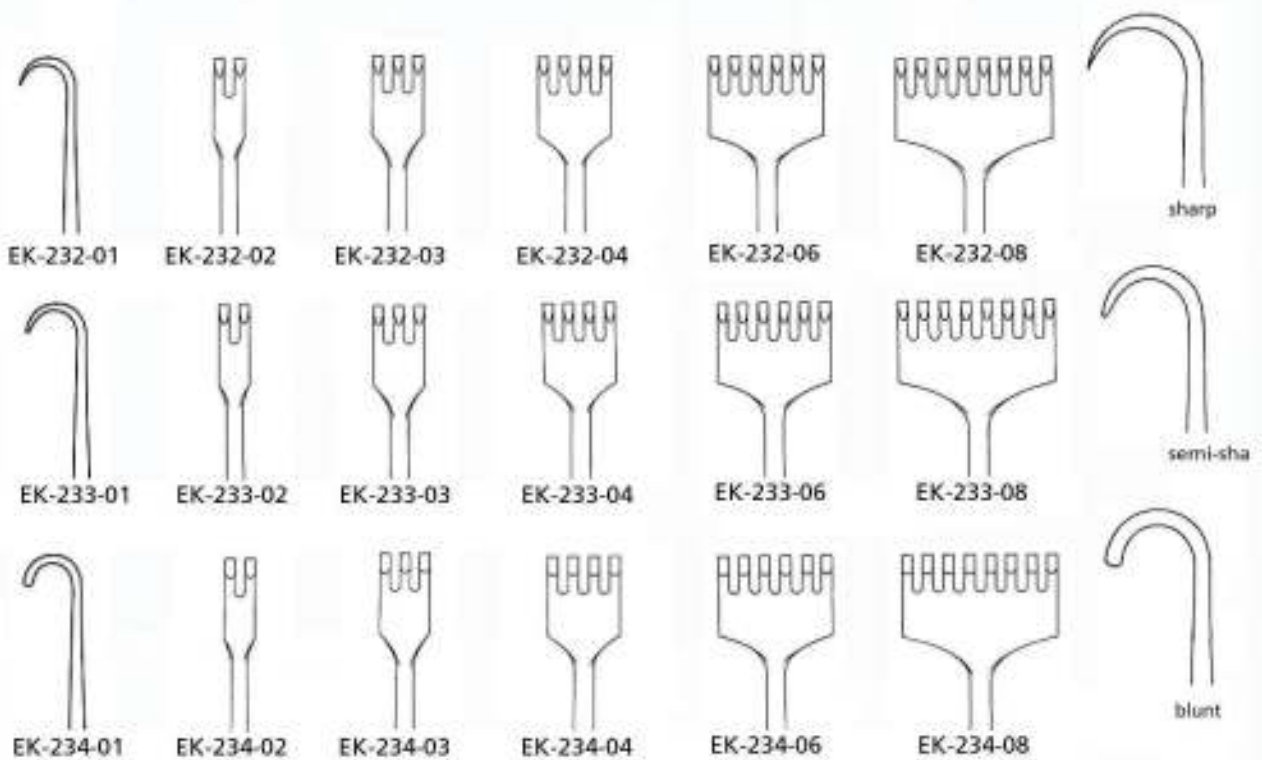

Ekartörler
Retractors
Wundhaken



KOCHER
22 cm/8^{3/4}"



EK-235-21



EK-237-20



KOCHER
22 cm/8^{3/4}"



EK-236-21



EK-238-20



24,5 cm/9^{3/4}"



EK-237-24



VOLKMANN
22,5 cm/9"



EK-239-01



EK-239-02



EK-239-03



EK-239-04



EK-239-05



EK-239-06



EK-239-07



EK-239-08



KOERTE
24 cm/9 1/2"



26 x 40 mm
Sharp
EK-240-08



26 x 40 mm
Blunt
EK-241-08



ISRAEL
25,5 cm /10"

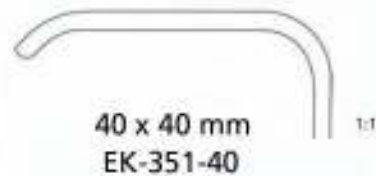

40 x 40 mm
EK-351-40

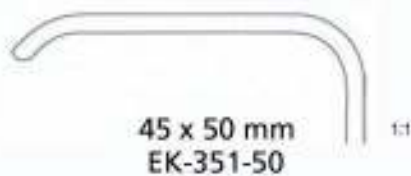

45 x 50 mm
EK-351-50

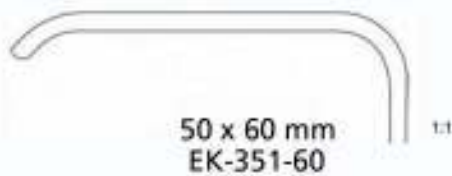

50 x 60 mm
EK-351-60



70 x 70 mm
EK-351-70

Ekartörler
Retractors
Wundhaken



ISRAEL
25 cm/10"

stumpf
blunt
mousse
romo
smusso



BI-634-40
40 x 40 mm



BI-634-50
45 x 50 mm



BI-634-60
50 x 60 mm



BI-634-70
70 x 70 mm



LANGENBECK
21 cm/8^{1/4}"

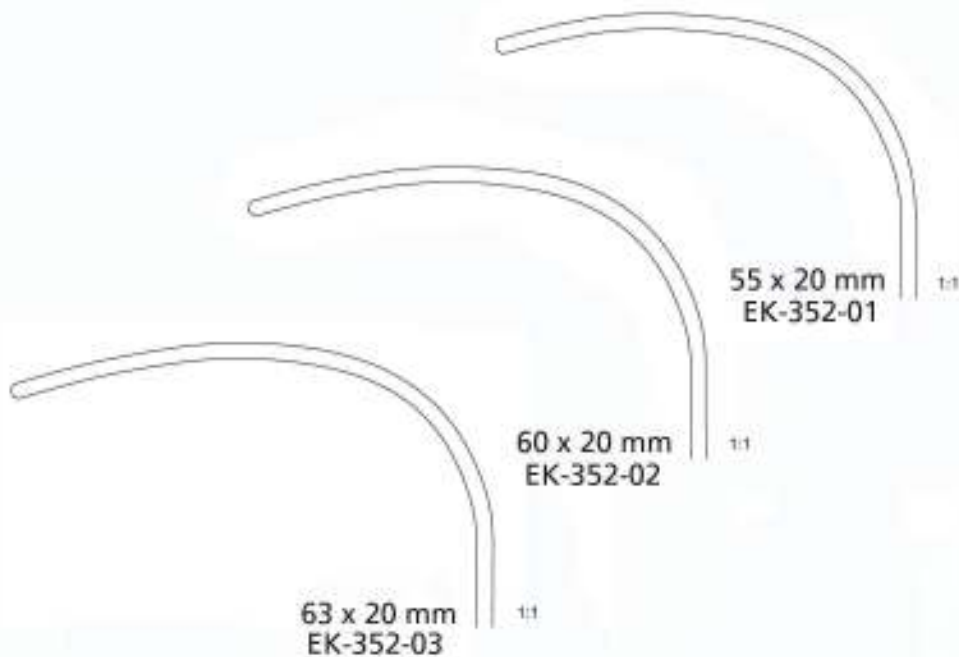

LANGENBECK
23 cm/9"
EK-354-01 / 04

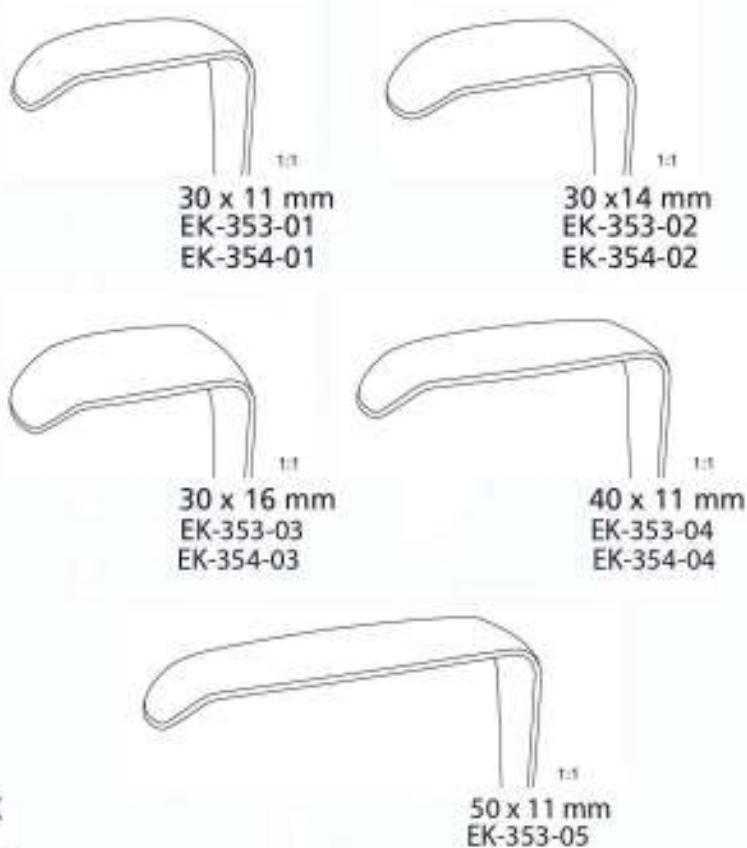

LANGENBECK
21 cm/8^{1/4}"
EK-353-01 / 05

Ekartörler
Retractors
Wundhaken



KOCHER-LANGENBECK
22 cm/8½"

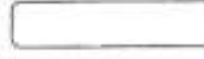

EK-355-01
25x6 mm



EK-355-04
35x15 mm



EK-355-02
35x8 mm



EK-355-05
40x11 mm



EK-355-03
35x11 mm



EK-355-06
55x11 mm



EK-355-07
70x14 mm



EK-355-08
80x12 mm



EK-355-09
80x16 mm

Ekartörler
Retractors
Wundhaken



KOCHER
23 cm/9"



40 x 18 mm
EK-356-18



60 x 20 mm
EK-356-20



75 x 30 mm
EK-356-30

75 x 40 mm
EK-356-40



SAUERBRUCH
22,5 cm/9"



44 x 16 mm
EK-357-01



55 x 22 mm
EK-357-02



72 x 19 mm
EK-357-03

Ekartörler
Retractors
Wundhaken



MEYERDING

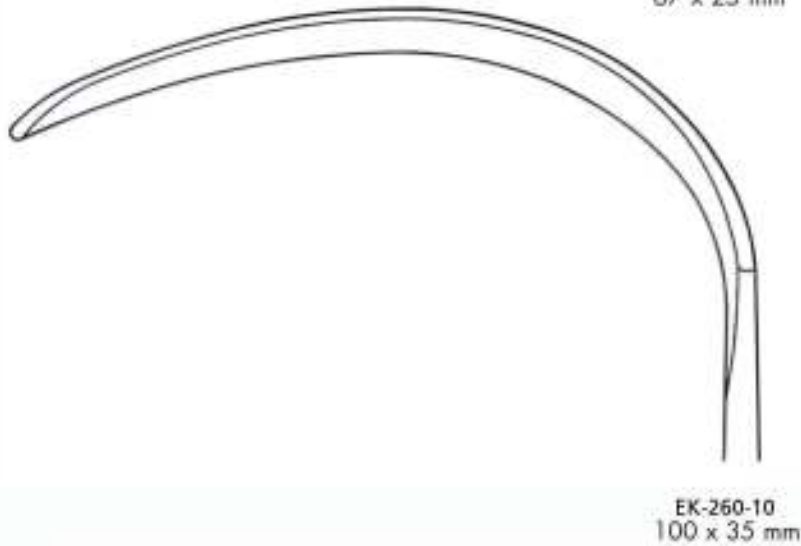
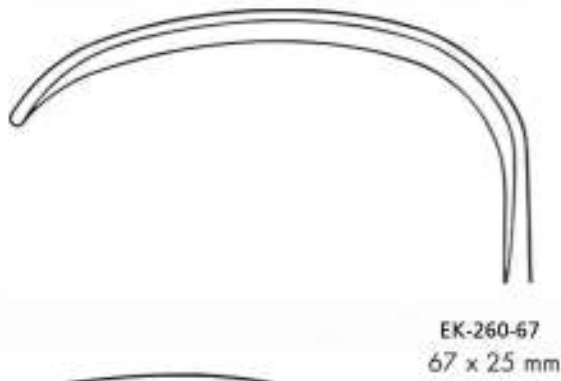
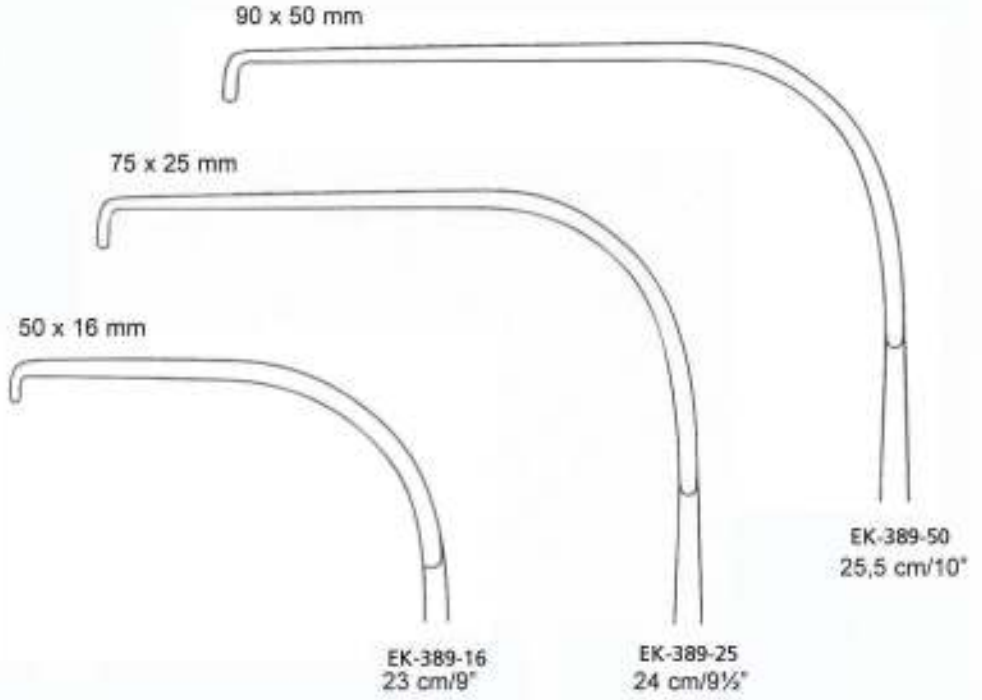

KOCHER WAGNER
28 cm/11"

Otomatik Ekartörler
Self-Retaining Retractors
Wundspreizer



WEITLANER



EK-435-10
11,5 cm/4½"
2 : 3
sharp



EK-436-10
11,5 cm/4½"
2 : 3
blunt



WEITLANER



EK-435-13
13 cm/4¼"
3 : 4
sharp

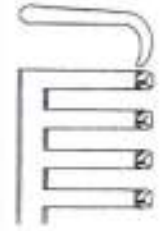

EK-436-13
13 cm/4¼"
3 : 4
blunt



WEITLANER

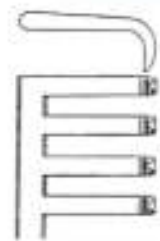

EK-435-16
16,5 cm 6½"
3 : 4
sharp



EK-436-16
16,5 cm 6½"
3 : 4
blunt



MOLLISON
EK-446-15
14 cm/5½"



2 : 2
sharp

Otomatik Ekartörler
Self-Retaining Retractors
Wundspreizer



3 : 4



JEFFERSON
EK-520-14
14 cm/5½"

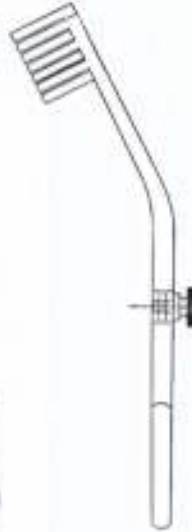

PLESTER
EK-477-10
10,5cm / 4



½



PLESTER
EK-478-10
10,5cm / 4



½



ADSON
3 : 4

Sharp

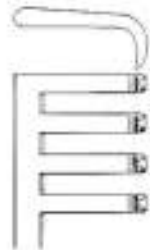

EK-458-13
13,5 cm/5¼"

Blount

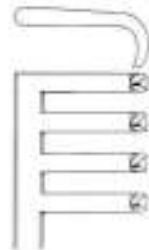

EK-459-13
13,5 cm/5¼"

Sharp

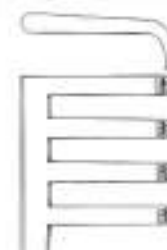

EK-458-20
21 cm/8¼"

Blount

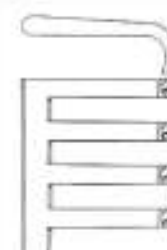

EK-459-20
20 cm/8"

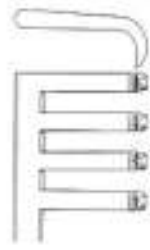

EK-458-16
16,5 cm/6½"



EK-459-16
16,5 cm/6½"



EK-458-25
24,5 cm/9¾"



EK-459-25
24,5 cm/9¾"

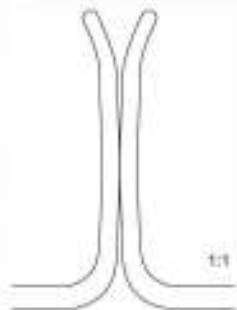

Mayo-Adams
EK-480-17
170-812-165



MISKIMON
EK-580-22
22 cm/8 1/2"
35 mm



EK-452-20
4 : 4
sharp

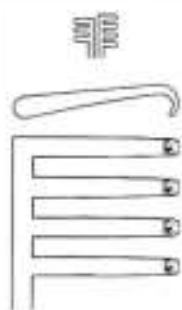

EK-453-20
4 : 4
blunt

ANDERSON-ADSON
20 cm/8"

Otomatik Ekartörler
Self-Retaining Retractors
Wundspreizer

idOL
CERRAHİ ALETLER
www.idolcerrahi.com

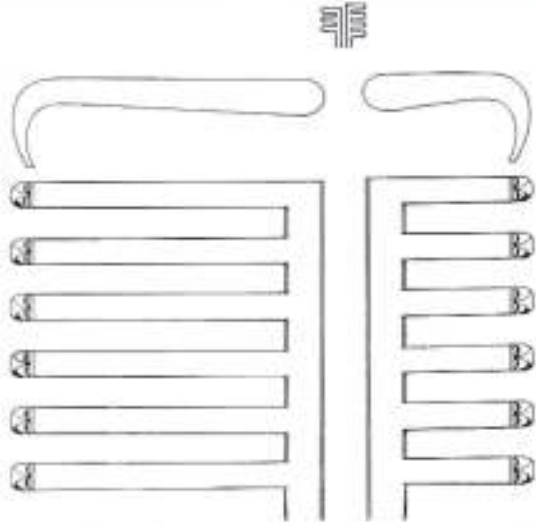

EK-457-01
6 : 6



26,5 cm/10½"

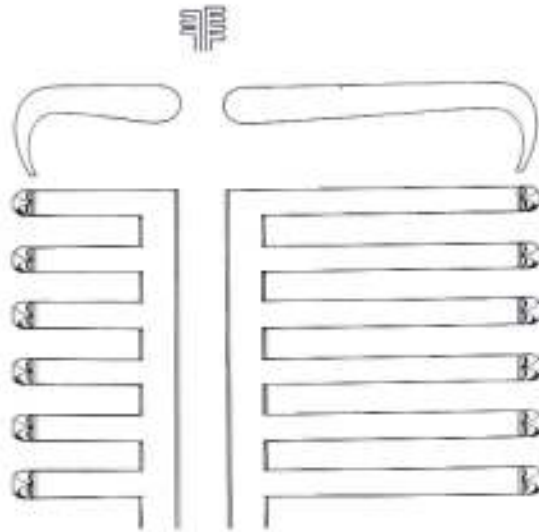

EK-457-02
6 : 6

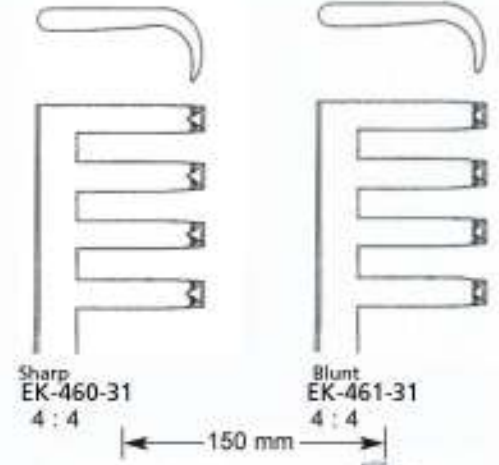

Sharp
EK-460-31
4 : 4

Blunt
EK-461-31
4 : 4

150 mm



BECKMANN
31 cm/30¼"



EK-464-01
30 mm
4 : 4



EK-465-01
30 mm
4 : 4



BECKMANN-ADSON
30,5 cm/30¼"



BECKMANN-EATON



7 : 7
EK-466-33
32 cm/12¼"

Otomatik Ekartörler
Self-Retaining Retractors
Wundspreizer

idOL
CERRAHİ ALETLER
www.idolcerrahi.com

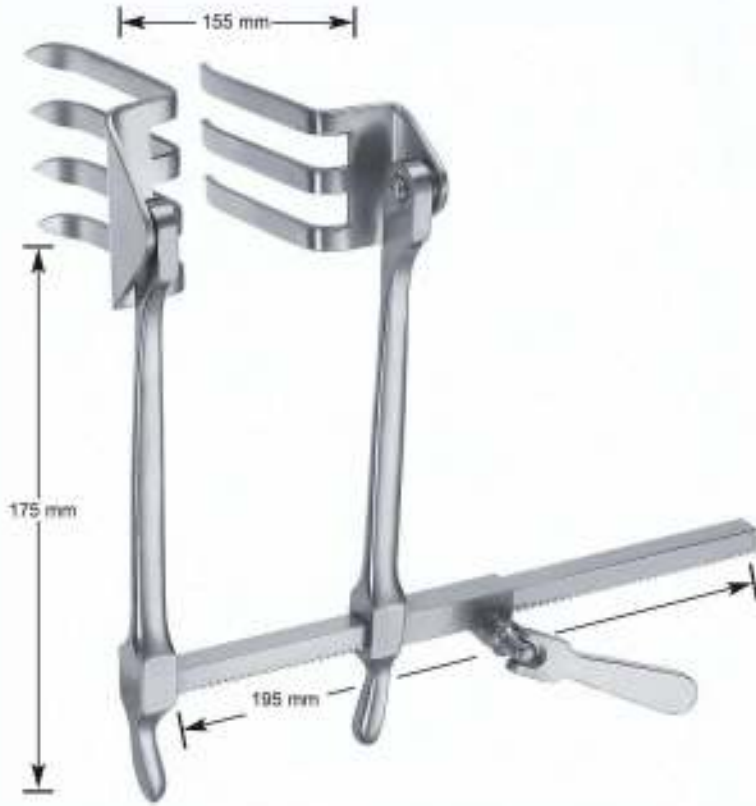

SCOVILLE-RICHTER
EK 617-00



62 x 52 mm
EK-617-01

62 x 37 mm
EK-617-02



EK-617-03
47 x 51 mm

EK-617-04
30 x 40 mm



EK-617-05
37 x 62 mm



SCOVILLE
EK-669-00

SCOVILLE-HAVERFIELD
EK-670-00



SCOVILLE

50 mm	EK-660-55
70 mm	EK-660-70
75 mm	EK 660-75



SCOVILLE

50 x 25 mm	EK-665-01
50 x 50 mm	EK-665-02
57 x 25 mm	EK-665-03
57 x 38 mm	EK-665-04
64 x 25 mm	EK-665-05
64 x 29 mm	EK-665-06
64 x 50 mm	EK-665-07
67 x 28 mm	EK-665-08
67 x 30 mm	EK-665-09
75 x 25 mm	EK-665-10
75 x 50 mm	EK-665-11
88 x 25 mm	EK-665-12
100 x 50 mm	EK-665-13



TAYLOR

47 x 37 mm	EK-666-01
48 x 50 mm	EK-666-02
64 x 50 mm	EK-666-03
64 x 64 mm	EK-666-04
80 x 57 mm	EK-666-05



MEYERDING

44 x 25 mm	EK-667-01
50 x 25 mm	EK-667-02
57 x 25 mm	EK-667-03
70 x 25 mm	EK-667-04
75 x 25 mm	EK-667-05
83 x 25 mm	EK-667-06
88 x 50 mm	EK-667-07



TAYLOR

75 x 32 mm	EK-668-01
100 x 42 mm	EK-668-02

Otomatik Ekartörler
Self-Retaining Retractors
Wundspreizer

idOL
CERRAHİ ALETLER
www.idolcerrahi.com

CASPAR



CASPAR

CASPAR

CASPAR

35 x 22 mm	EK-682-01
40 x 22 mm	EK-682-02
45 x 22 mm	EK-682-03
50 x 22 mm	EK-682-04
55 x 22 mm	EK-682-05
60 x 22 mm	EK-682-06
65 x 22 mm	EK-682-07
70 x 22 mm	EK-682-08

35 x 37 mm	EK-683-01
40 x 37 mm	EK-683-02
45 x 37 mm	EK-683-03
50 x 37 mm	EK-683-04
55 x 37 mm	EK-683-05
60 x 37 mm	EK-683-06
65 x 37 mm	EK-683-07
70 x 37 mm	EK-683-08

35 x 52 mm	EK-684-01
40 x 52 mm	EK-684-02
45 x 52 mm	EK-684-03
50 x 52 mm	EK-684-04
55 x 52 mm	EK-684-05
60 x 52 mm	EK-684-06
65 x 52 mm	EK-684-07
70 x 52 mm	EK-684-08



CASPAR lateral blades

35 mm	EK-710-01
40 mm	EK-710-02
45 mm	EK-710-03
50 mm	EK-710-04
55 mm	EK-710-05
60 mm	EK-710-06
65 mm	EK-710-07
75 mm	EK-710-08
85 mm	EK-710-09



CASPAR medial blades

35 mm	EK-710-10
40 mm	EK-710-11
45 mm	EK-710-12
50 mm	EK-710-13
55 mm	EK-710-14
60 mm	EK-710-15
65 mm	EK-710-16
70 mm	EK-710-17



CASPAR

40 mm	EK-711-01
45 mm	EK-711-02
50 mm	EK-711-03
55 mm	EK-711-04
60 mm	EK-711-05
65 mm	EK-711-06
75 mm	EK-711-07
85 mm	EK-711-08

Pensetler
Dissecting Forceps
Pinzetten



11,5 cm/4½"	FO-100-11
13 cm/5"	FO-100-13
14,5 cm/5¾"	FO-100-14
16 cm/6¼"	FO-100-16
18 cm/7"	FO-100-18
20 cm/8"	FO-100-20
25 cm/10"	FO-100-25
30 cm/12"	FO-100-30

STANDART



11,5 cm/4½"	FO-110-11
13 cm/5"	FO-110-13
14,5 cm/5¾"	FO-110-14
16 cm/6¼"	FO-110-16
18 cm/7"	FO-110-18
20 cm/8"	FO-110-20
25 cm/10"	FO-110-25
30 cm/12"	FO-110-30

STANDART



ADSON

12 cm/4¾"	FO-200-12
15 cm/6"	FO-200-15



ADSON micro

12 cm/4¾"	FO-201-12
15 cm/6"	FO-201-15



ADSON

12 cm/4¾"	FO-202-12
15 cm/6"	FO-202-15



ADSON micro

12 cm/4¾"	FO-203-12
15 cm/6"	FO-203-15



JEFFERSON
18 cm/7"



FO-205-01

FO-205-02

Pensetler
Dissecting Forceps
Pinzetten

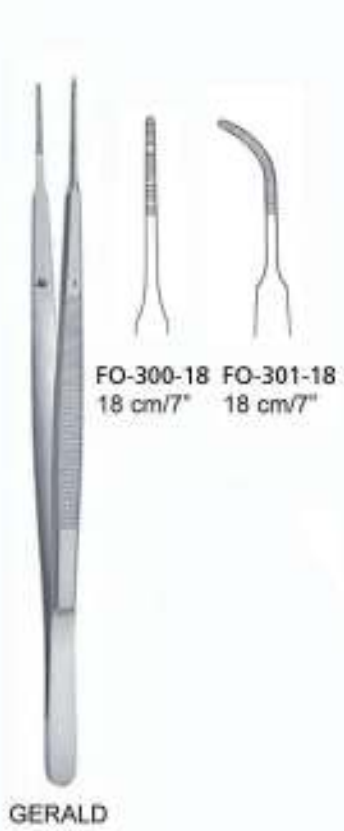

Pensetler
Dissecting Forceps
Pinzetten

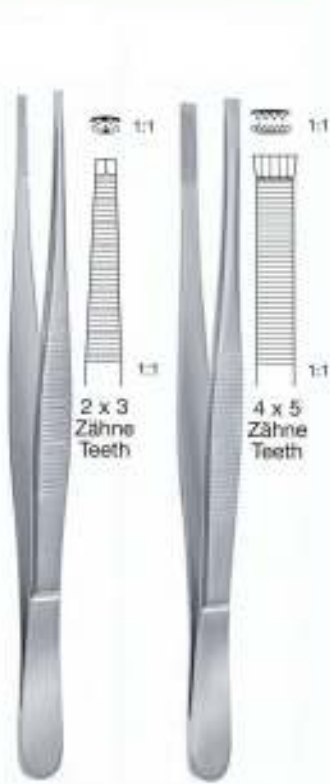

ADLERKREUTZ

15 cm / 6"	FO-396-15	FO-397-15
20 cm / 8"	FO-396-20	FO-397-20
25 cm / 10"	FO-396-25	FO-397-25



SINGLY

23 cm / 9" FO-502-23



NELSON

23 cm / 9" FO-503-23



Russ. Mod.

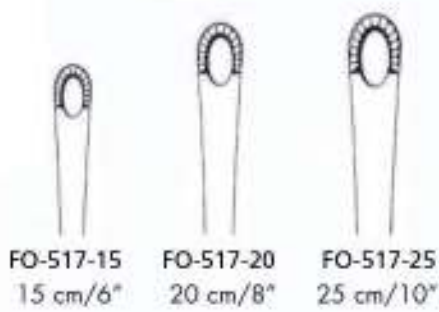

DUVAL
14 cm / 5 1/2"



FO-519-14



LAZAR
15,5 cm/6"

FO-526-03
18,5 cm/7¼"

Mikro Pensetler
Micro Forceps
Mikro-Pinzetten



AUSTIN
FO-602-14
14 cm/5½"

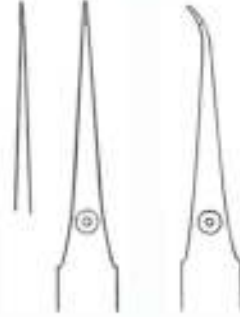

FO-608-12 FO-609-12
12 cm/4¾" 12 cm/4¾"
0,3 mm 0,3 mm

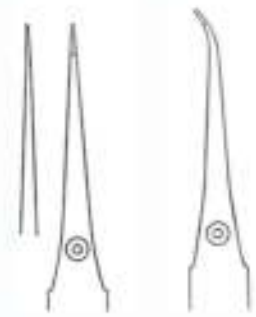

FO-610-15 FO-611-15
15 cm/6" 15 cm/6"
0,3 mm 0,3 mm

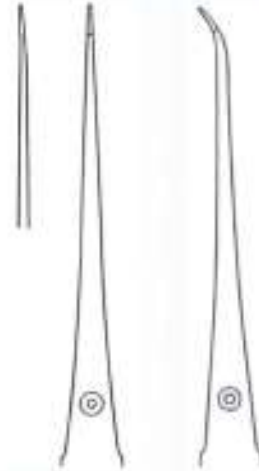

FO-612-18 FO-613-18
18 cm/7" 18 cm/7"
0,6 mm 0,6 mm



FO-614-23
23 cm/9"
0,6 mm

ATRAUMA



DE BAKEY



DE BAKEY

1,0 mm



1,5 mm



2,0 mm



16 cm/6¼"
20 cm/8"
24 cm/9½"
30 cm/12"

FO-960-15
FO-960-20
FO-960-24

FO-950-16
FO-950-20
FO-950-24

FO-951-16
FO-951-20
FO-951-24
FO-951-30

2,8 mm



3,5 mm



16 cm/6¼"
20 cm/8"
24 cm/9½"
30 cm/12"

FO-952-16
FO-952-20
FO-952-24
FO-952-30

FO-953-20
FO-953-24
FO-953-30

Pensetler
Dissecting Forceps
Pinzetten



14,5 cm/5¾" FO 399-14
18 cm/7" FO 399-18
20 cm/8" FO 399-20
25 cm/10" FO 399-25



POTTS-SMITH

15,5 cm/6" FO 400-15
18 cm/7" FO 400-18
20 cm/8" FO 400-20
23 cm/9" FO 400-23



ADSON

12 cm/4¾" FO 405-12
15 cm/6" FO 405-15



ADSON

12 cm/4¾" FO 406-12
15 cm/6" FO 406-15



WANGENSTEEN

15 cm/6" FO 413-15
23 cm/9" FO 413-23

Organ Tutma Pensleri
Organ Tissue Grasping Forceps
Organ Gewebe und Darmfaßzangen

ATRAUMA



DE BAKEY



ALLIS-Atrauma



HM 370-16
16 cm/6¼"



HM 370-20
20 cm/8"



HM 370-25
25 cm/10"



HM 370-30
30 cm/12"

ATRAUMA



DE BAKEY



BABCOCK-Atrauma



HM 371-16
16 cm/6¼"



HM 371-21
20 cm/8"

Organ Tutma Pensleri
Organ Tissue Grasping Forceps
Organ Gewebe und Darmfaßzangen

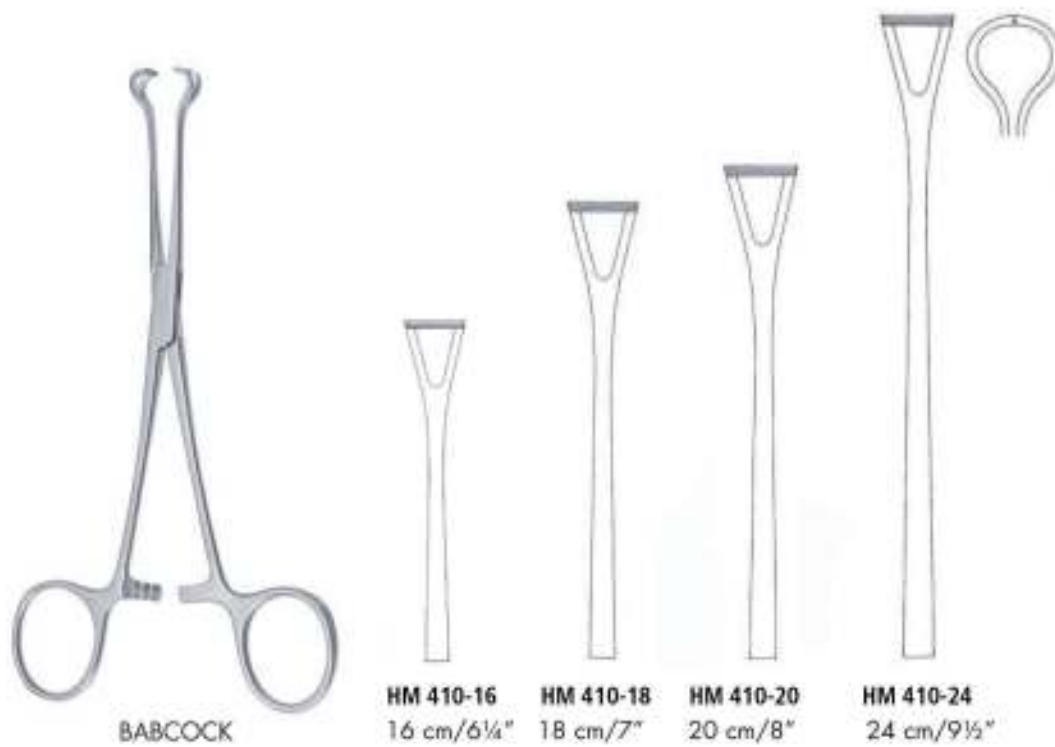
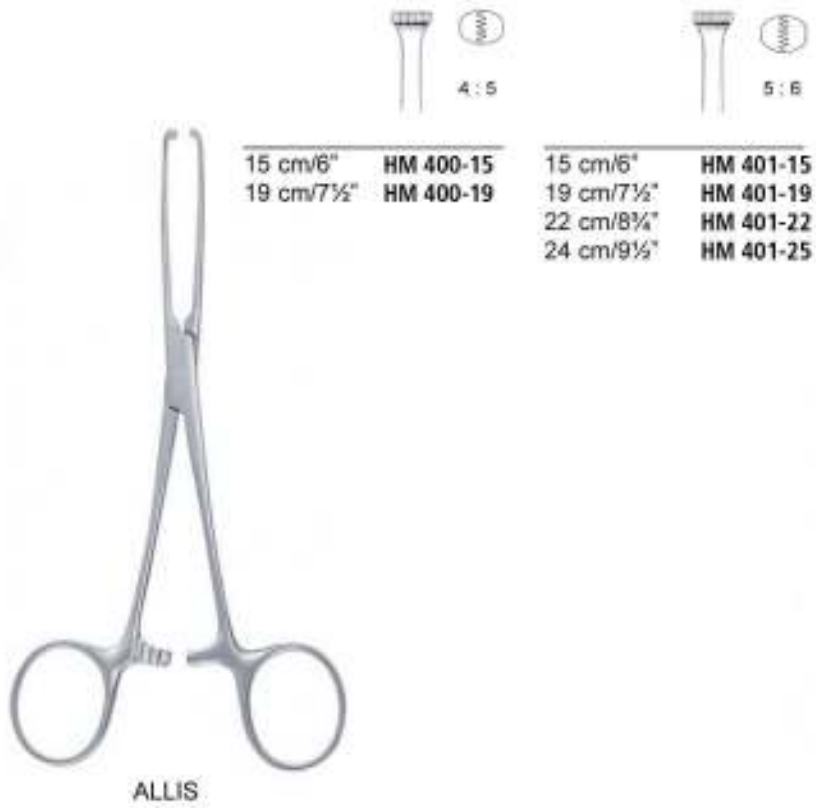

Organ Tutma Pensleri
Organ Tissue Grasping Forceps
Organ Gewebe und Darmfaßzangen



HM 353-19
18 cm/7"

HM 354-20
20 cm/8"



HM 372-19
18 cm/7"

HM 372-23
23 cm/9"

ATRAUMA



DE BAKAY



DIETRICH

HM 470-01
49 mm/2"

HM 470-02
53 mm/2"

HM 470-03
59 mm/2¼"

HM 471-01
43 mm/1½"

HM 471-02
45 mm/1¾"

HM 471-03
50 mm/2"

Buldog Klempleri
Bulldog Clamps
Bulldogklemmen



— DIEFFENBACH —

35 mm/1 1/2"	HM 476-03	HM 477-03
50 mm/2"	HM 476-05	HM 477-05



— DIEFFENBACH —

58 mm/2 1/4"	HM 476-06	HM 477-06
--------------	-----------	-----------



— JOHN-HOPKINS —

50 mm/2"	HM 480-04	HM 481-04
55 mm/2 1/4"	HM 480-05	HM 481-05
65 mm/2 1/2"	HM 480-06	HM 481-06
70 mm/2 3/4"	HM 480-07	HM 481-07
90 mm/3 1/2"	HM 480-09	HM 481-09



HM 480-00
23 cm/8 1/4"

Hassas Hemostatik Klempler
Delicate Haemostatic Forceps
Feine Arterienklemmen



HALSTED-MOSQUITO micro



HM 436-10
10 cm/4"



HM 436-12
12 cm/4¾"



HM 437-10
10 cm/4"



HM 437-12
12 cm/4¾"

1:2



HM 438-10
10 cm/4"

1:2



HM 438-12
12 cm/4¾"

1:2



HM 439-10
10 cm/4"

1:2



HM 439-12
12 cm/4¾"



HALSTED-MOSQUITO



HM 440-12
12,5 cm/5"



HM 440-14
14,5 cm/5¾"



HM 441-12
12,5 cm/5"



HM 441-14
14,5 cm/5½"

1:2



HM 442-12
12,5 cm/5"

1:2



HM 442-14
14,5 cm/5¾"

1:2



HM 443-12
12,5 cm/5"

1:2



HM 443-14
14,5 cm/5½"

Hassas Hemostatik Klempler
Delicate Haemostatic Forceps
Feine Arterienklemmen



HALSTED-MOSQUITO

HM 445-18
18 cm/7"



HM 445-21
21 cm/8¼"



HM 446-18
18 cm/7"



HM 446-21
21 cm/8¼"



HM 447-18
18 cm/7"



HM 447-21
21 cm/8¼"



HM 448-18
18 cm/7"



HM 448-21
21 cm/8¼"



LERICHE
15 cm/6"

HM 450-15



HM 451-15



HM 452-15



HM 453-15



HM 454-14



HM 455-14



PROVIDENCE-HOSPITAL
14 cm/5½"

Hassas Hemostatik Klempler
Delicate Haemostatic Forceps
Feine Arterienklemmen

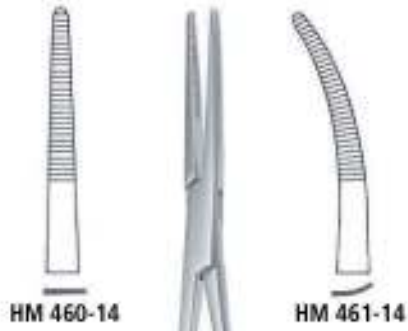

KELLY
14 cm/5½"



KELLY-RANKIN
16 cm/6¼"



CRILE
14 cm/5½"



Hassas Hemostatik Klempler
Delicate Haemostatic Forceps
Feine Arterienklemmen



CRILE-RANKIN
16 cm/6¼"



HM 470-16



HM 471-16



1:2
HM 472-16



1:2
HM 473-16



FUCHSIG
19 cm/7½"



HM 408-18



ADSON
18,5 cm/7¼"



HM 418-19



HM 419-19

Hassas Hemostatik Klempler
Delicate Haemostatic Forceps
Feine Arterienklemmen



SPENCER-WELLS



HM 430-13
13 cm/5"



HM 430-14
14 cm/5½"



HM 430-15
15 cm/6"



HM 430-18
18 cm/7"



HM 430-20
20 cm/8"



HM 431-13
13 cm/5"



HM 431-14
14 cm/5½"



HM 431-15
15 cm/6"



HM 431-18
18 cm/7"



HM 431-20
20 cm/8"



HEISS
20 cm/8"



HM 505-01



HM 505-02



HM 505-03

Hemostatik Klempler
Haemostatic Forceps
Arterienklemmen

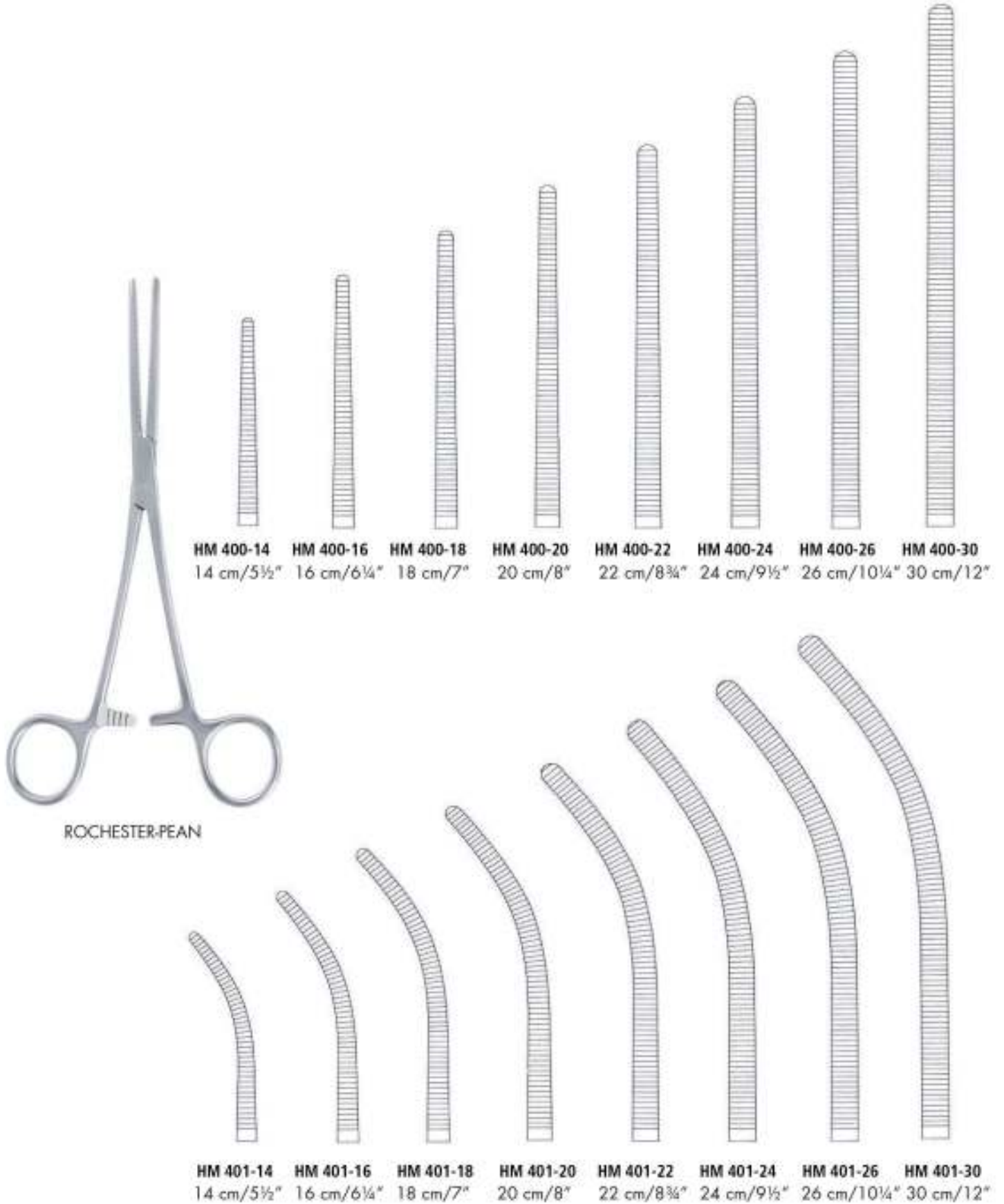

Hemostatik Klempeler
Haemostatic Forceps
Arterienklemmen

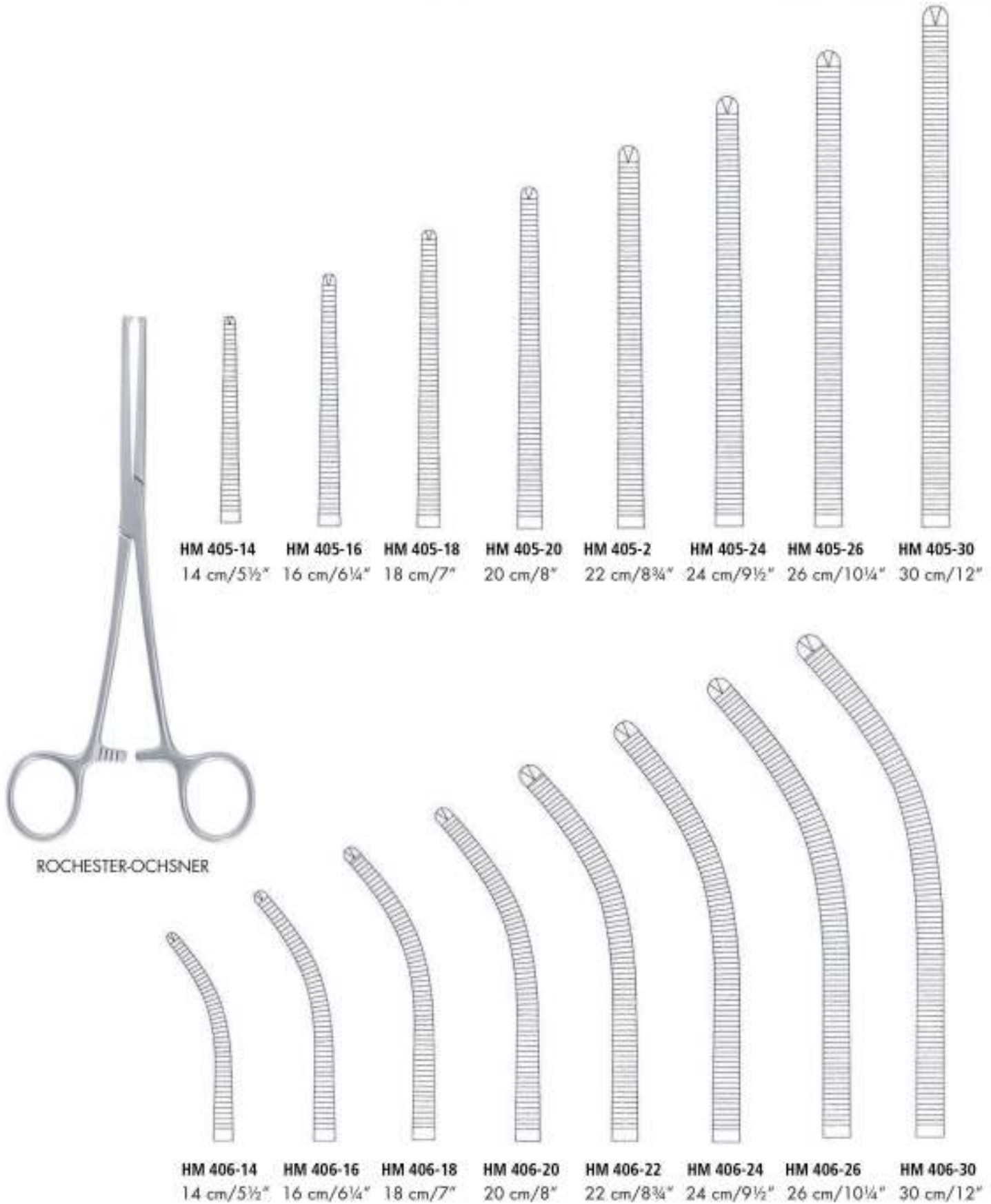

Diseksiyon ve Dikiş Klempleri
Dissecting and Ligature Forceps
Präparier und Ligaturklemmen

idOL
CERRAHİ ALETLER
www.idolcerrahi.com

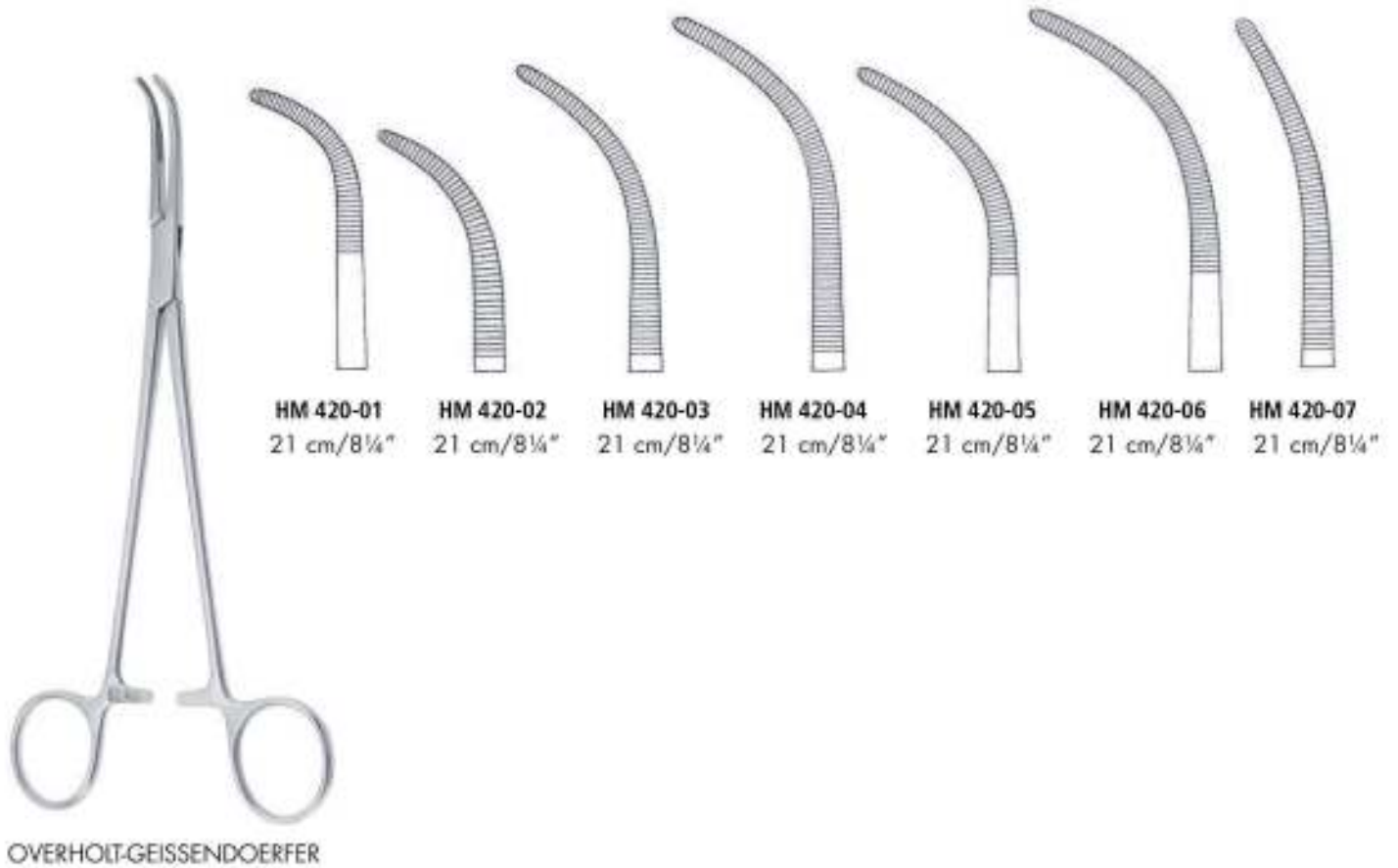

Diseksiyon ve Dikiş Klempleri
Dissecting and Ligature Forceps
Präparier und Ligaturklemmen



OVERHOLT

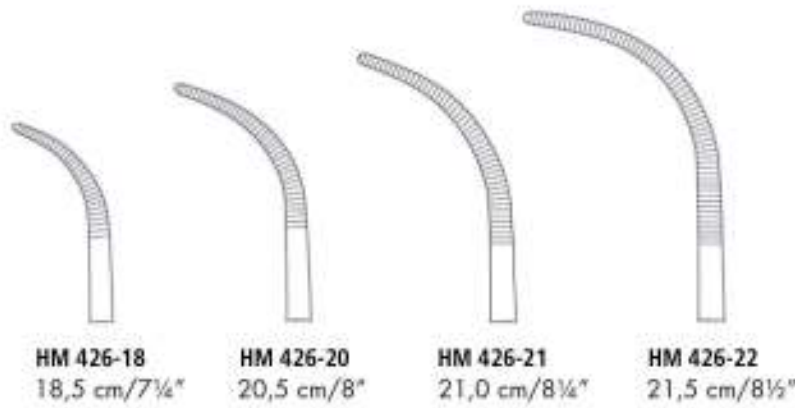

Baby MIXTER

HM 520-02
14 cm/5½"

HM 522-18
18 cm/7"



MIXTER

Alet Askısı , Tüp Klempleri
Safety Pins , Tubing Clamps
Sterilisierklammern , Schlauchklemme



BUNT
HM 160-10
10,5 cm 4 1/8"



MAYO
HM 160-14
14 cm 5 1/2"



PRESBYTERIAN HOSPITAL
16 cm / 6 1/4" **HM 810-16**
18 cm / 7" **HM 810-18**

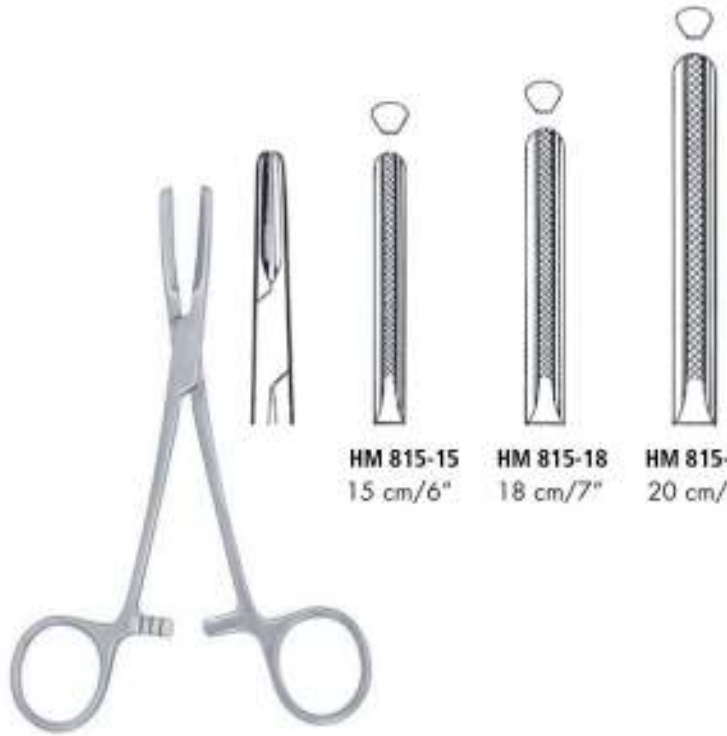

HM 815-15
15 cm / 6"

HM 815-18
18 cm / 7"

HM 815-20
20 cm / 8"

Çamaşır Klempleri
Towel Clamps
Tuchklemmen



SCHAEDEL
HM 800-09
9 cm/3½"



JONES
5,5 cm/2¼" **HM 820-05**
8,5 cm/3¼" **HM 820-09**

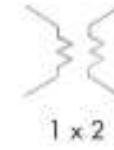

1 x 2

LANE
13 cm/5" **HM 840-13**
15,5 cm/6" **HM 840-15**
19,5 cm/7¾" **HM 840-20**



BACKHAUS
9 cm/3½" **HM 860-08**
11 cm/4¼" **HM 860-11**
13 cm/5" **HM 860-13**
15 cm/6" **HM 860-15**



BALL AND SOCKET
HM 880-13
13 cm/5"

Osteotom , Çizil , Gujlar
Osteotomes , Chisels , Gouges
Osteotome , Flach- , Hohlmeißel

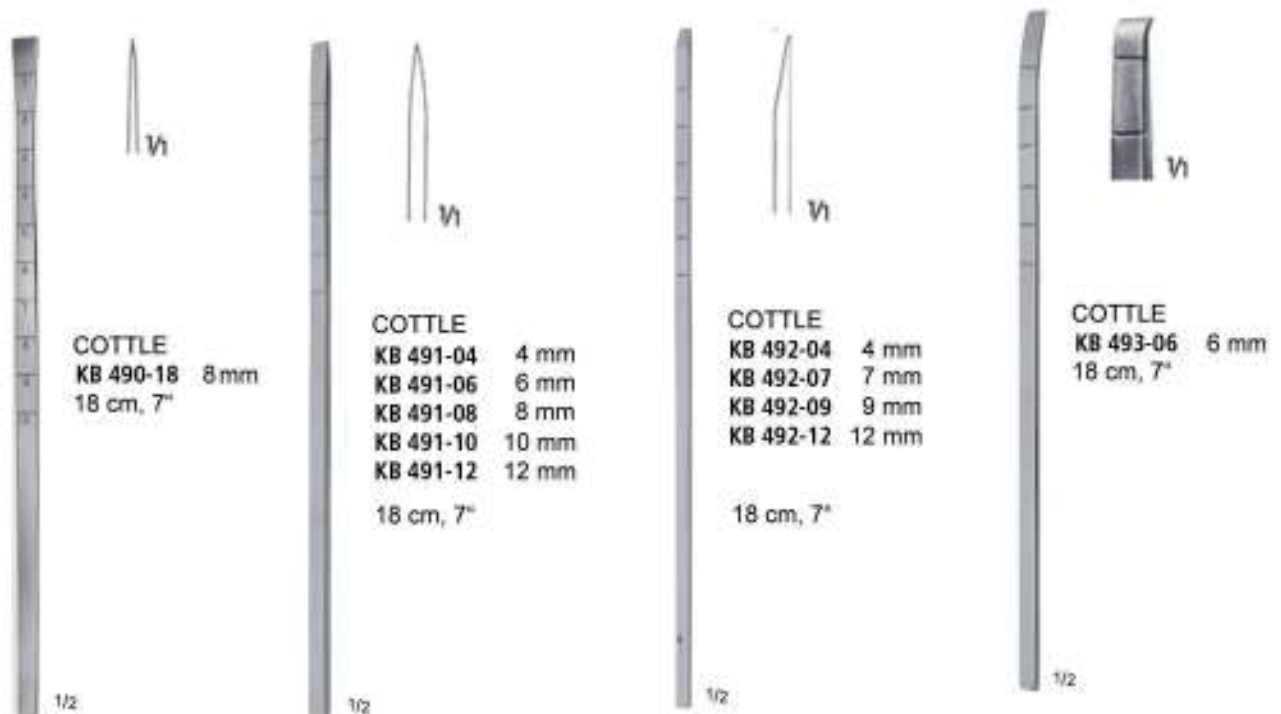

Osteotom , Çizil , Gujlar
Osteotomes , Chisels , Gouges
Osteotome , Flach- , Hohlmeißel



KL 100-06 6mm
KL 100-13 13mm
KL 100-19 19mm
KL 100-25 25mm
KL 100-32 32mm

Hibbs
24,5 cm / 9 1/2"

1/2



KL 101-06 6mm
KL 101-13 13mm
KL 101-19 19mm
KL 101-25 25mm
KL 101-32 32mm

Hibbs
24,5 cm / 9 1/2"

1/2



KL 102-06 6mm
KL 102-13 13mm
KL 102-19 19mm
KL 102-25 25mm
KL 102-32 32mm

Hibbs
24,5 cm / 9 1/2"

1/2



KL 103-06 6mm
KL 103-13 13mm
KL 103-19 19mm
KL 103-25 25mm
KL 103-32 32mm

Hibbs
24,5 cm / 9 1/2"

1/2



KL 104-06 6mm
KL 104-09 9mm
KL 104-13 13mm
KL 104-16 16mm
KL 104-19 19mm
KL 104-25 25mm
KL 104-32 32mm

Smith-Petersen
20,5 cm / 8 1/4"

1/2



KL 105-06 6mm
KL 105-09 9mm
KL 105-13 13mm
KL 105-16 16mm
KL 105-19 19mm
KL 105-25 25mm
KL 105-32 32mm

Smith-Petersen
20,5 cm / 8 1/4"

1/2



KL 106-06 6mm
KL 106-09 9mm
KL 106-13 13mm
KL 106-16 16mm
KL 106-19 19mm
KL 106-25 25mm
KL 106-32 32mm

Smith-Petersen
20,5 cm / 8 1/4"

1/2



KL 107-06 6mm
KL 107-09 9mm
KL 107-13 13mm
KL 107-16 16mm
KL 107-19 19mm
KL 107-25 25mm
KL 107-32 32mm

Smith-Petersen
20,5 cm / 8 1/4"

1/2

Osteotom , Çizil , Gujlar
Osteotomes , Chisels , Gouges
Osteotome , Flach- , Hohlmeißel



Lambotte-Mini
 KB 498-04 4mm
 KB 498-06 6mm
 KB 498-08 8mm
 KB 498-10 10mm
 KB 498-12 12mm
 KB 498-15 15mm
 12,5 cm / 4 1/8"

1/2



STILLE
 KL 200-10 10 mm
 KL 200-12 12 mm
 KL 200-15 15 mm
 KL 200-20 20 mm
 KL 200-25 25 mm
 20,5 cm

1/2



1/1



STILLE
 KL 201-10 10 mm
 KL 201-12 12 mm
 KL 201-15 15 mm
 KL 201-20 20 mm
 KL 201-25 25 mm
 20,5 cm

1/2



1/1



WALTER
 KL 202-10 10 mm
 KL 202-15 15 mm
 20,5 cm

1/2



1/1



STILLE
 KL 203-08 8 mm
 KL 203-10 10 mm
 KL 203-12 12 mm
 KL 203-15 15 mm
 KL 203-20 20 mm
 KL 203-25 25 mm
 20,5 cm

1/2



1/1



STILLE
 KL 204-10 10 mm
 KL 204-12 12 mm
 KL 204-15 15 mm
 KL 204-20 20 mm
 KL 204-25 25 mm
 20,5 cm

1/2



1/1



STILLE
 KL 205-10 10 mm
 KL 205-12 12 mm
 KL 205-15 15 mm
 KL 205-20 20 mm
 KL 205-25 25 mm
 20,5 cm

1/2



1/1

Osteotom , Çizil , Gujlar
Osteotomes , Chisels , Gouges
Osteotome , Flach- , Hohlmeißel

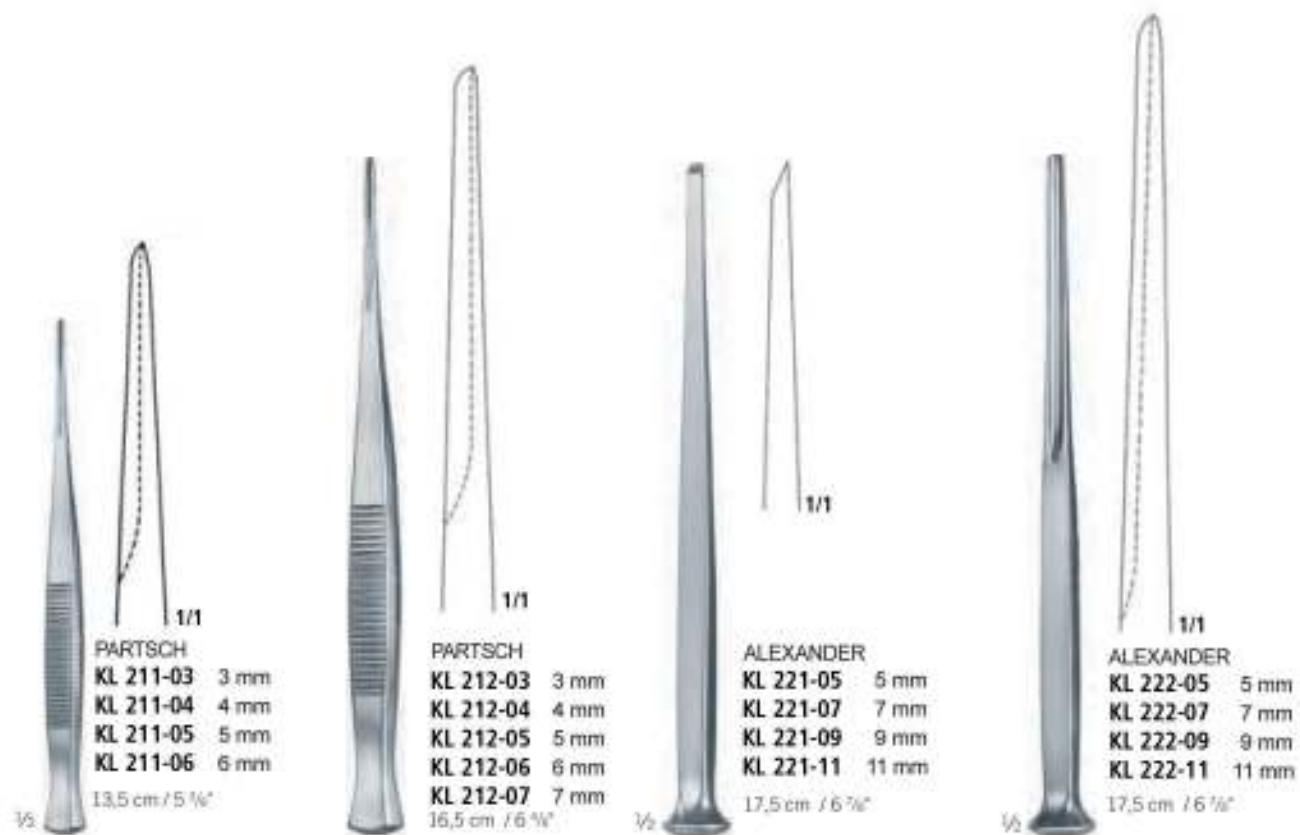
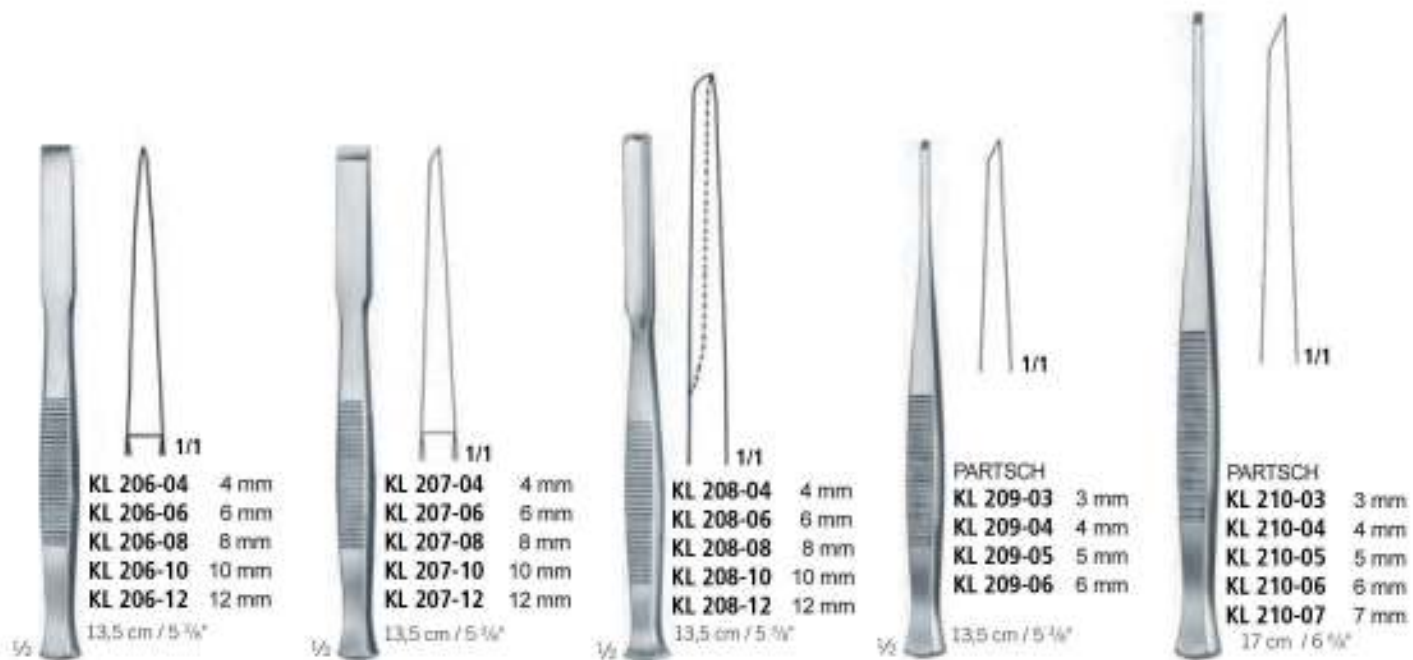

Osteotom , Çizil , Gujlar
Osteotomes , Chisels , Gouges
Osteotome , Flach- , Hohlmeißel

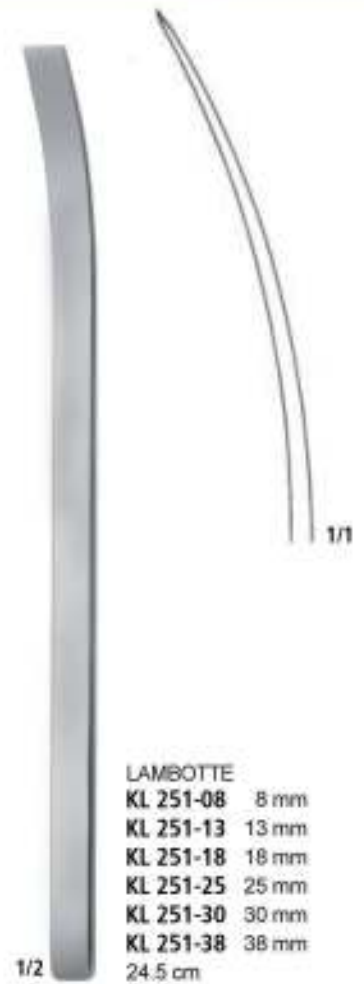

Osteotom , Çizil , Gujlar
Osteotomes , Chisels , Gouges
Osteotome , Flach- , Hohlmeißel



Osteotom , Çizil , Gujlar
Osteotomes , Chisels , Gouges
Osteotome , Flach- , Hohlmeißel



KL 409-05 5 mm
KL 409-10 10 mm
KL 409-16 16 mm
KL 409-25 25 mm
length 45 mm



Osteotom , Çizil , Gujlar
Osteotomes , Chisels , Gouges
Osteotome , Flach- , Hohlmeißel

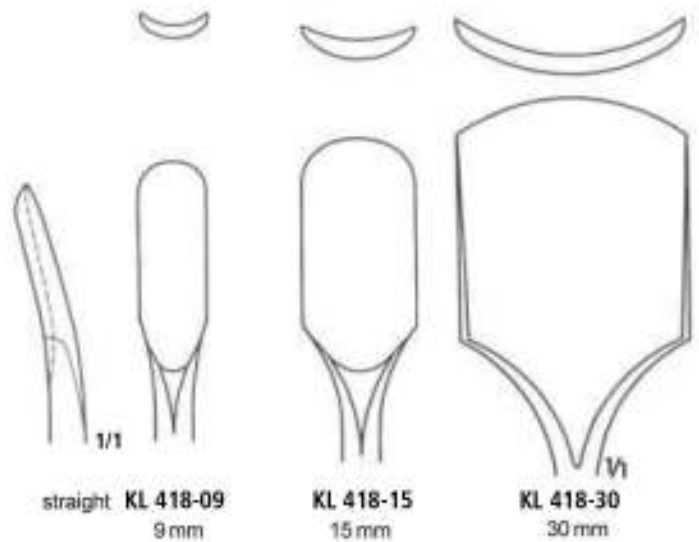
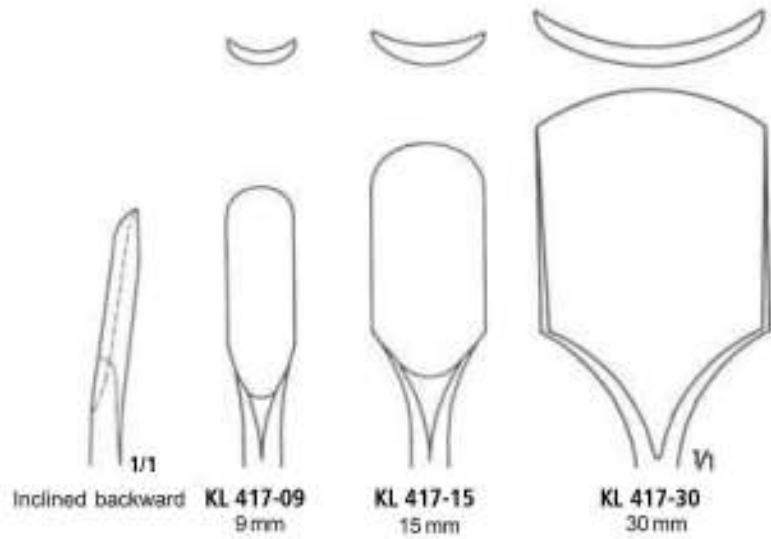
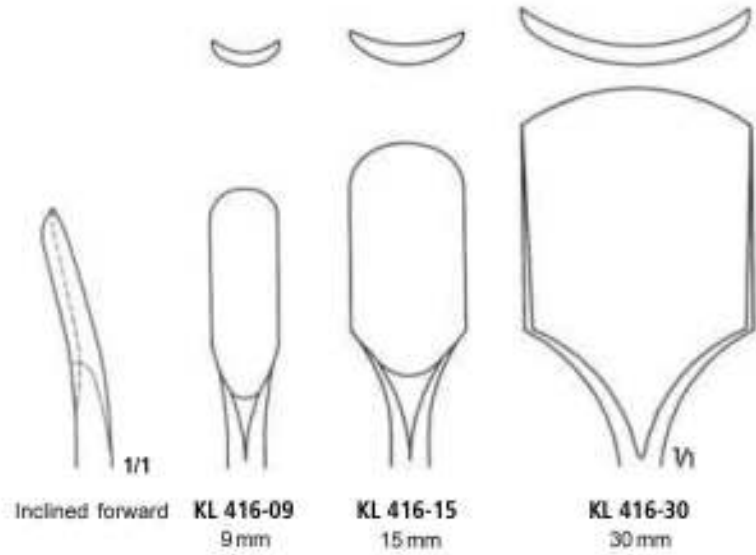

Çekiçler
Mallets
Hämmer



Ø 25 mm

KB 900-18 140 gr
Plastic disks
18.5 cm



Ø 30 mm

COTTLE
KB 902-18 240 gr
18.5 cm



Ø 40 mm

OMBREDANNE
KB 902-24 550 gr
24 cm



Ø 45 mm

BERGMANN
KB 906-24 300 gr
24.5 cm



Ø 20 mm

MEAD
KL 600-20 185 gr
Plastic disc
19 cm



Ø 22 mm

KL 600-22 165 gr
19 cm



Ø 27 mm

HAJEK
KL 601-21 140 gr
21.5 cm



Ø 30 mm

KL 602-24 215 gr
Plastic disc
24.5 cm



Cerrahi Makaslar
Surgical Scissors
Chirurgische Scheren

idOL
CERRAHİ ALETLER
www.idolcerrahi.com



MA 100-13
13 cm



MA 100-14
14.5 cm



MA 100-15
15 cm



MA 100-16
16.5 cm



MA 100-17
17.5 cm

VI



MA 101-11
11.5 cm



MA 101-13
13 cm



MA 101-14
14.5 cm



MA 101-15
15 cm



MA 101-16
16.5 cm



MA 101-17
17.5 cm

VI

Cerrahi Makaslar
Surgical Scissors
Chirurgische Scheren

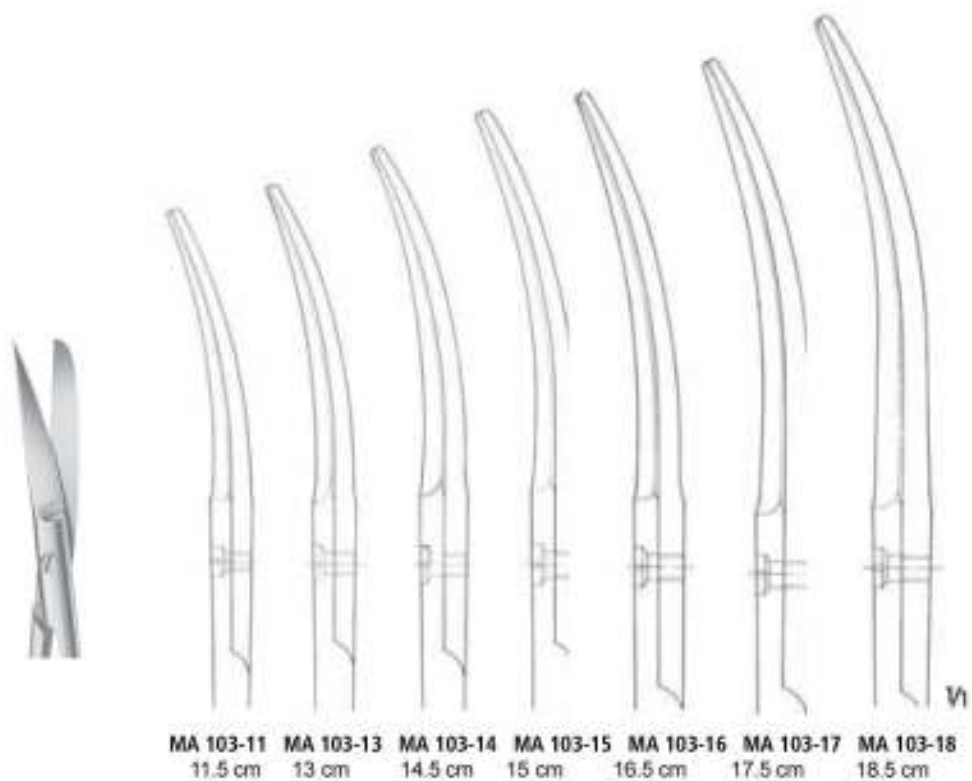

Cerrahi Makaslar
Surgical Scissors
Chirurgische Scheren

idOL
CERRAHİ ALETLER
www.idolcerrahi.com



Diseksiyon Makasları
Dissecting Scissors
Präparierscheren

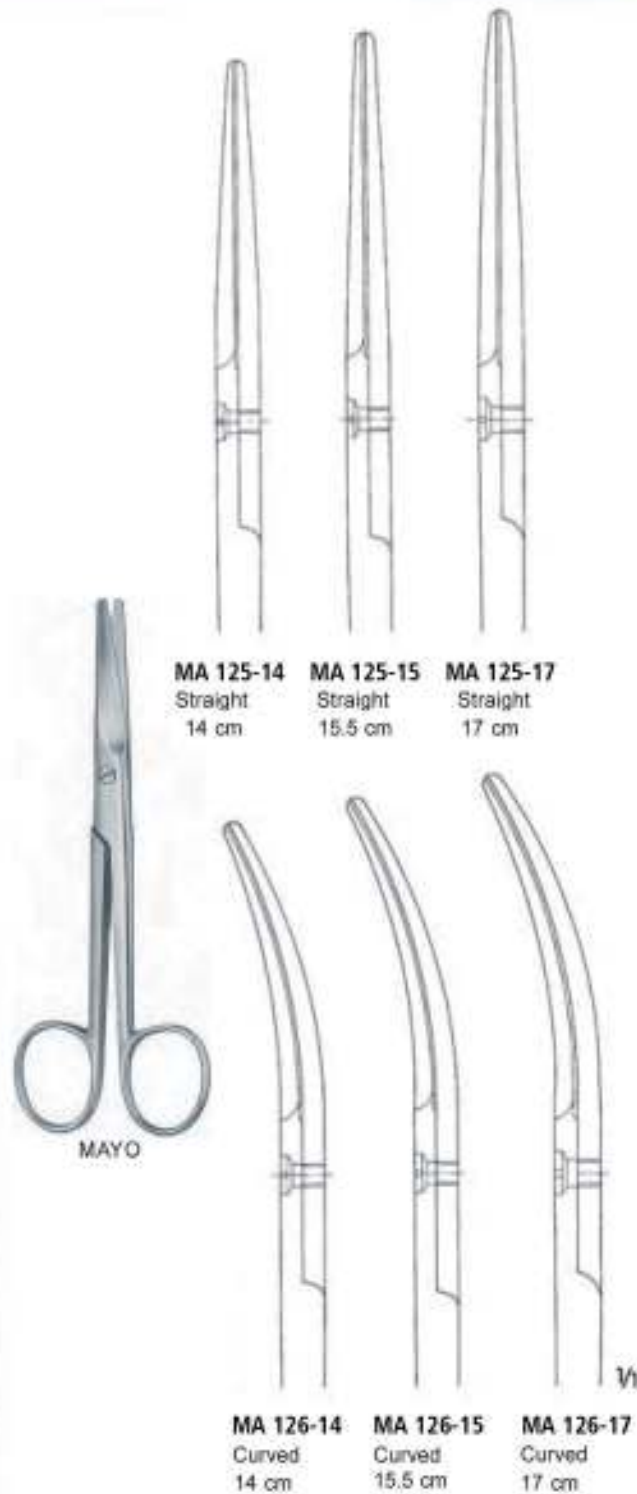
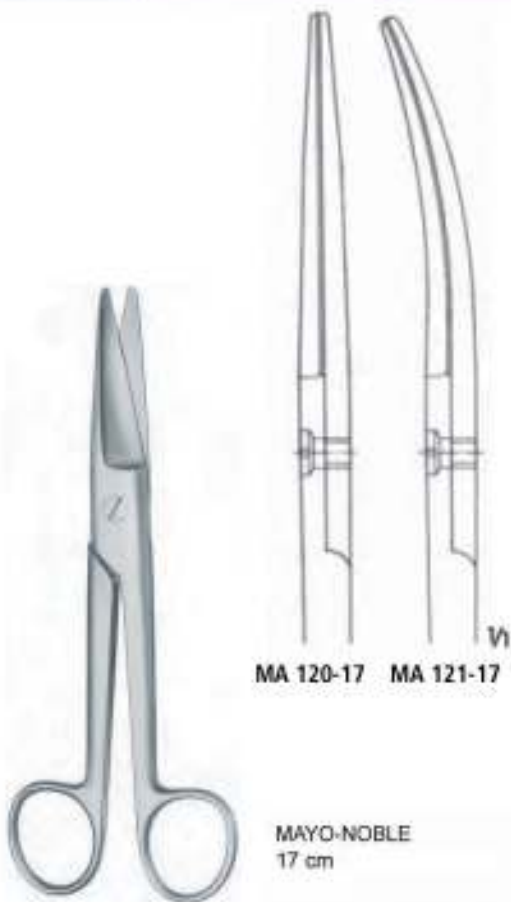

Diseksiyon Makasları
Dissecting Scissors
Präparierscheren



METZENBAUM

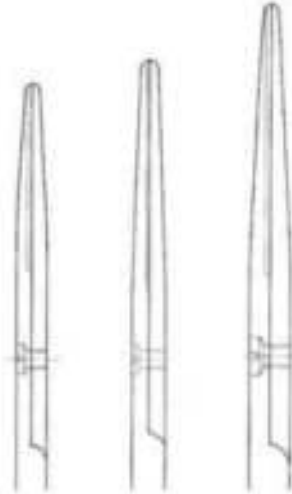

MA 149-14 Straight 14.5 cm
MA 214-18 Straight 18 cm
MA 214-20 Straight 20 cm

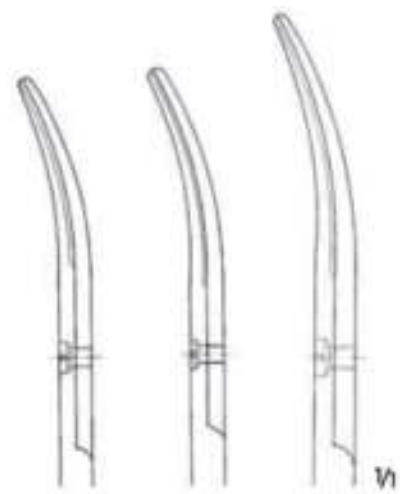

MA 150-14 Curved 14.5 cm
MA 215-18 Curved 18 cm
MA 215-20 Curved 20 cm



MA 219-15
Curved
15 cm

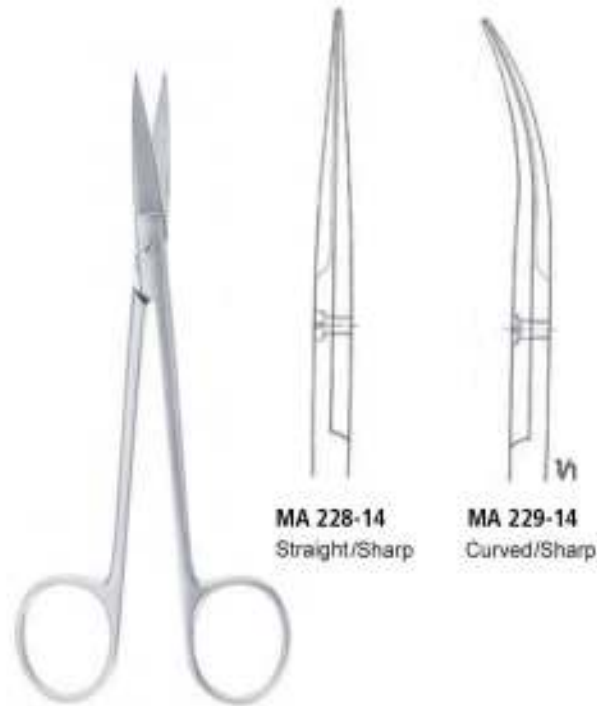

JOSEPH
15 cm

MA 228-14
Straight/Sharp

MA 229-14
Curved/Sharp

Diseksiyon Makasları
Dissecting Scissors
Präparierscheren



11 cm

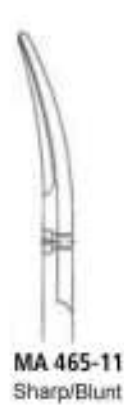
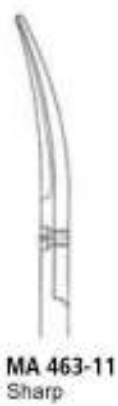
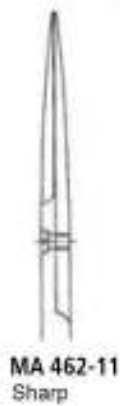

LANDOLT
12 cm



9 cm



STEVENS
11 cm

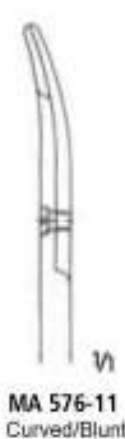

Bandaj Makasları
Plaster Scissors
Gipsscheren



Mikro Makaslar
Micro Scissors
Mikro-Federscheren



VANNAS
12 cm

MA 917-01

MA 917-02

MA 917-03



12 cm

MA 929-01 MA 929-02



14.5 cm

MA 950-15

MA 951-15



16cm

MA 958-15

MA 959-15

Alçı Ayırıcılar
Plaster Spreaders
Gipsspreizer

idOL
CERRAHİ ALETLER
www.idolcerrahi.com



HENIG
OF 200-27
27 cm



OF 201-23
23 cm



OF 202-29
29 cm



With Removable Jaws.



WOLFF
OF 203-18 18 cm
OF 203-24 24 cm



STILLE
OF 204-37
37 cm

iDOL
CERRAHİ ALETLER
www.idolcerahi.com

Tel Kesme Pensleri
Wire Cutting Pliers
Drahtschneidezange



OF 205-47
For cutting off wires
screws, pins, etc. up to \varnothing 6 mm
47 cm

Tel Kesme Pensleri
Wire Cutting Pliers
Drahtschneidezange

idOL
CERRAHİ ALETLER
www.idolcerrahi.com



OF 206-14
14.5 cm



For soft wire \varnothing 1.5 mm
For hard wire \varnothing 1.0 mm



OF 207-14
14.5 cm



For soft wire \varnothing 2.0 mm
For hard wire \varnothing 1.5 mm



OF 208-22
22 cm



For soft wire \varnothing 3.5 mm
For hard wire \varnothing 2.5 mm



OF 211-17 \varnothing 9 mm
17 cm



OF 212-24
24 cm

For soft wire \varnothing 2.0 mm
For hard wire \varnothing 1.6 mm



OF 213-18
18 cm

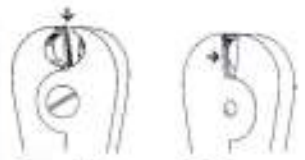

For soft wire \varnothing 2.0 mm
For hard wire \varnothing 1.5 mm

Tel Kesme Pensleri
Wire Cutting Pliers
Drahtschneidezange



Tel Kesme Pensleri
Wire Cutting Pliers
Drahtschneidezange

idOL
CERRAHİ ALETLER
www.idolcerrahi.com



ANGEL
OF 218-13 13 cm



OF 219-01
15 cm



OF 219-02
16 cm



LOUTE
OF 350-22
Wire tightener, 1.0 mm diam
22 cm



OF 400-14
14 cm



17 cm



OF 450-17

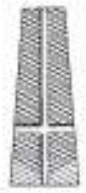

OF 451-17

Tel Tutma Pensleri
Wire Holding Forceps
Drahtfaßzangen



OF 452-19
19 cm



OF 455-18
18.5 cm



OF 456-20
20 cm



OF 457-02
14.5 cm



OF 457-03
18 cm



OF 457-04
18 cm



OF 458-01
13 cm



OF 458-02
18 cm

Pançlar
Punches
Stanzen

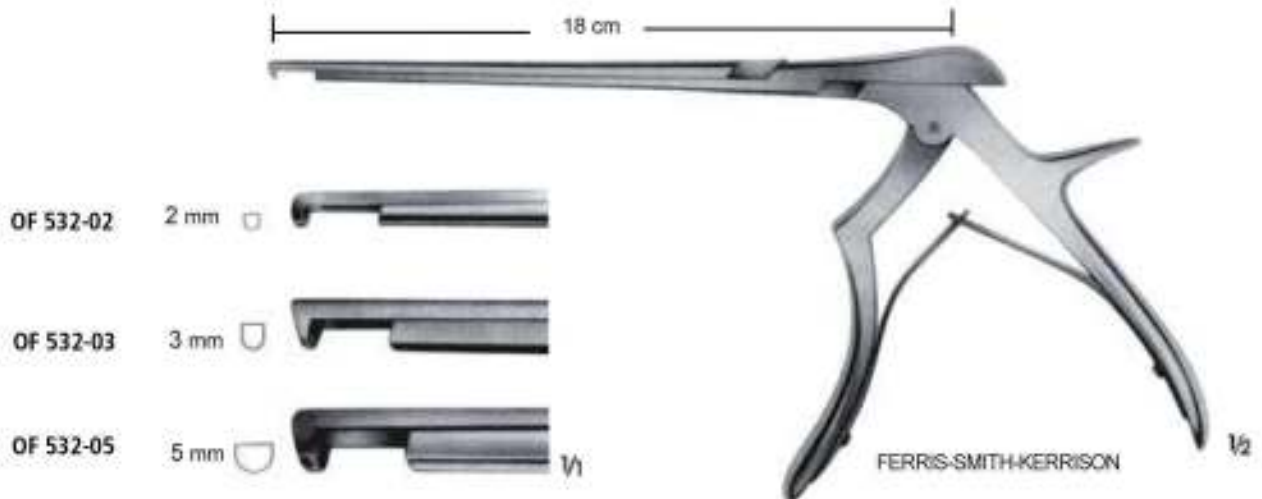
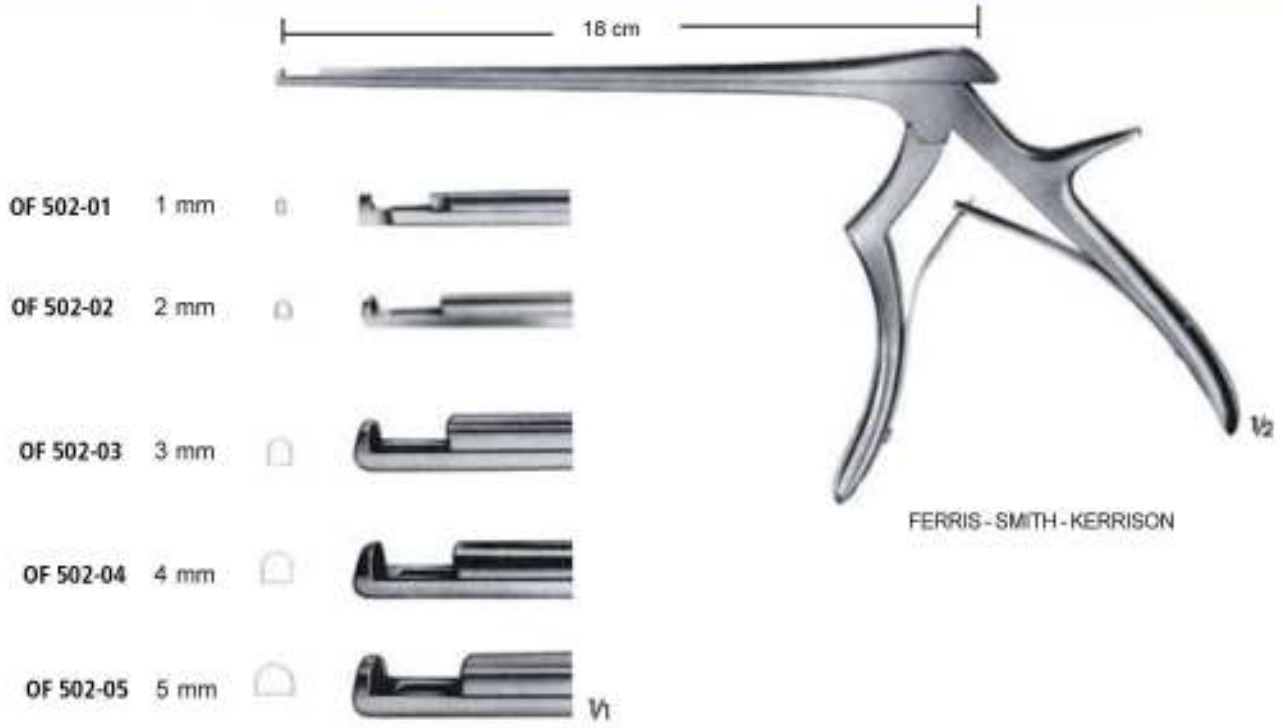

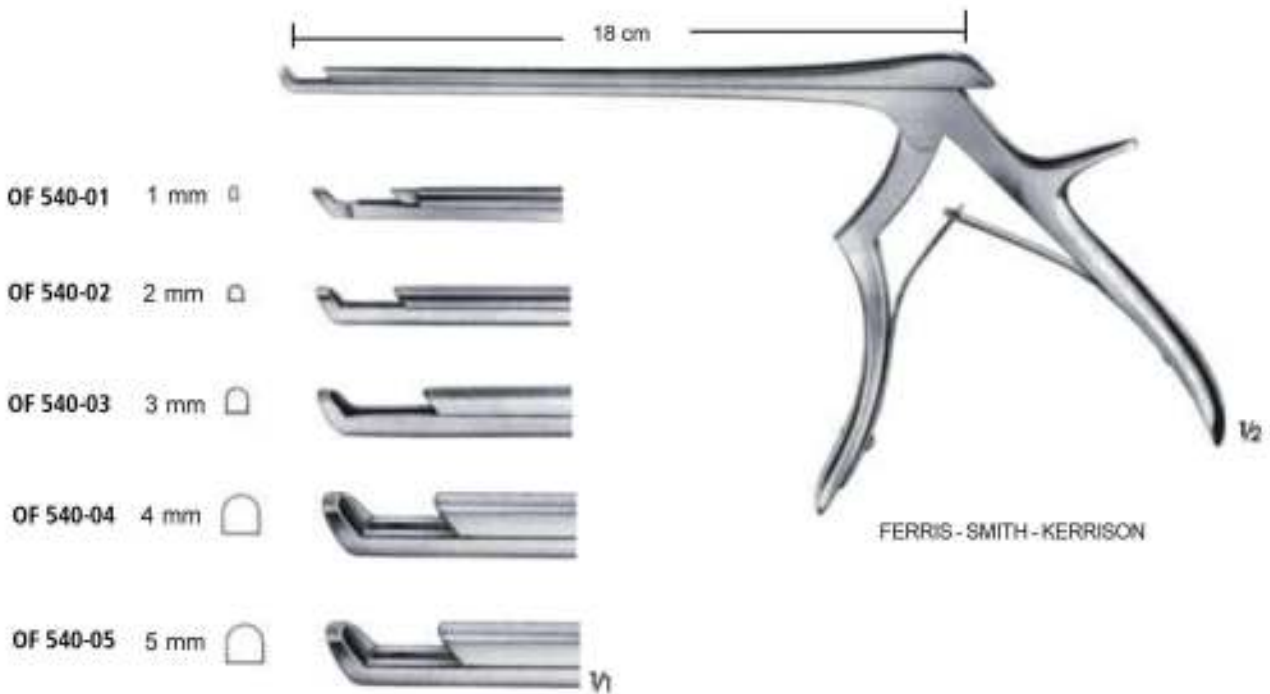
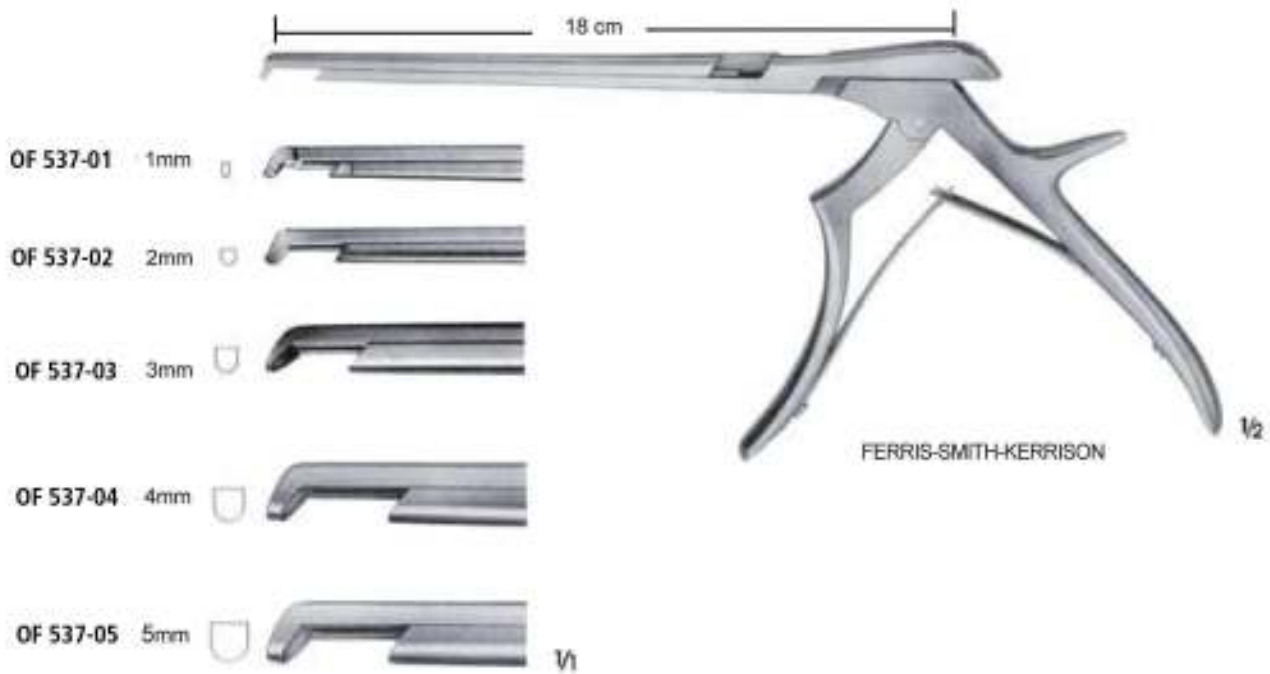

Amputasyon Testerleri
Amputation Saws
Amputationssagen



GIGLI
OF 940-30 30 cm
OF 940-40 40 cm
OF 940-50 50 cm
2 Tellii/ With 2 wires



GIGLI
OF 665-00
Sap / Handle



SATTERLEE
OF 670-00
29 cm



DEMEL

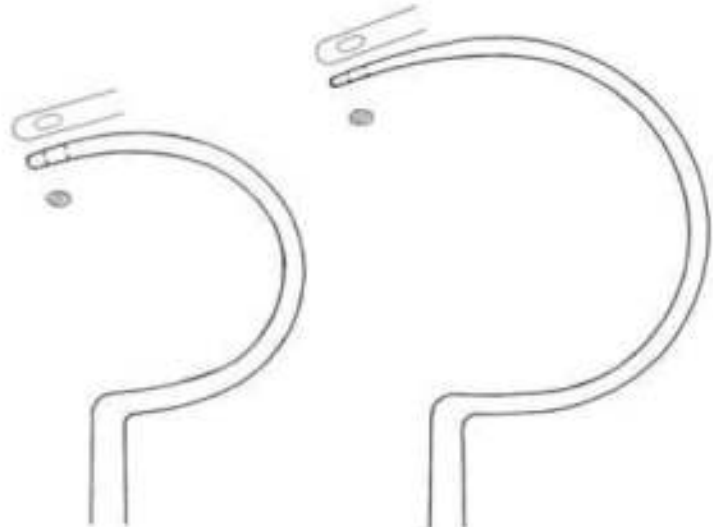

OF 810-28
27,5 cm

OF 810-29
28,5 cm



OF 810-30
30,5 cm

Tornavidalar
Screwdrivers
Schraubendreher



OF 720-20
20 cm

OF 720-25
25 cm



OF 724-20
20 cm

OF 724-25
25 cm



OF 721-20
20 cm

OF 721-20
25 cm



OF 725-20
20 cm

OF 725-25
25 cm



OF 722-20
20 cm

OF 722-20
25 cm



OF 723-20
20 cm

OF 723-25
25 cm



OF 726-20
20 cm

OF 726-20
25 cm

1.5 mm

3.5 mm

2.5 mm



Traksiyon Aletleri
Wire Extension
Drahtextension



OF 880-11

Wire traction bow ,adjustable , with 3 hooks,
small size 180x100mm

OF 880-17

Wire traction bow ,adjustable , with 3 hooks,
large size 270x160mm



OF 910-04
Drilling chuck \varnothing 4,5 mm



OF 910-16
Drilling chuck \varnothing 6.35 mm
16 cm



BUNNEL
OF 900-16
16 cm

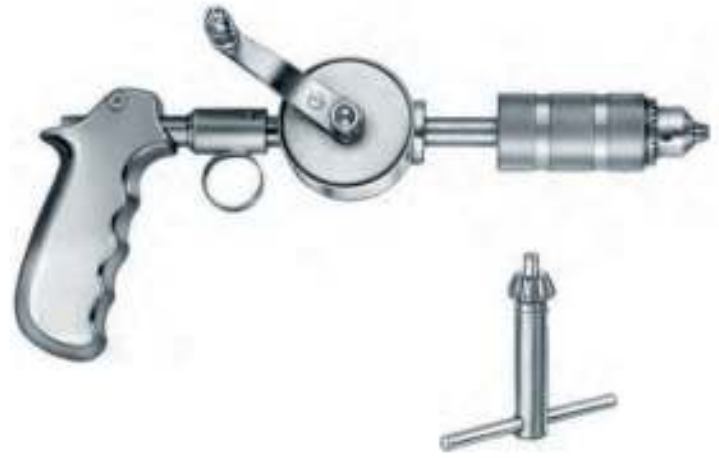

OF 910-26
26 cm



STILLE
OF 911-00

Raspalar
Raspatories
Raspatorien



HALLE
KB 350-18
16 cm/6¼"
3,5 mm

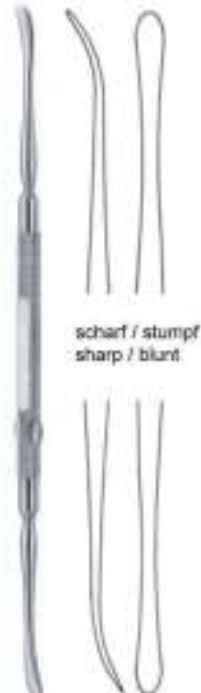

⅓
FREER
KB 353-18
18,5 cm/7¼"

scharf / stumpf
sharp / blunt



⅓
FREER YASARGIL
KB 354-18
18,5 cm/7¼"

scharf / scharf
sharp / sharp



PENFIELD
KB 356-20
20,5 cm/8"



DAVIS
KB 468-24
24,5 cm/9¾"



⅓
WILLIGER
OG 220-01
16 cm/6¼"

5 mm



⅓
WILLIGER
OG 220-02
17 cm/6¾"

5,5 mm



⅓
SEBILAU
OG 220-17
17 cm/6¾"

5 mm

Raspalar
Raspatories
Raspatorien



QUERVAIN
OG 221-19
20 cm/8"



LANGENBECK
20 cm/8"

OG 222-01
8 mm

OG 222-02
10 mm



LANGENBECK
OG 223-23
23 cm



BRUNS
23 cm/9"

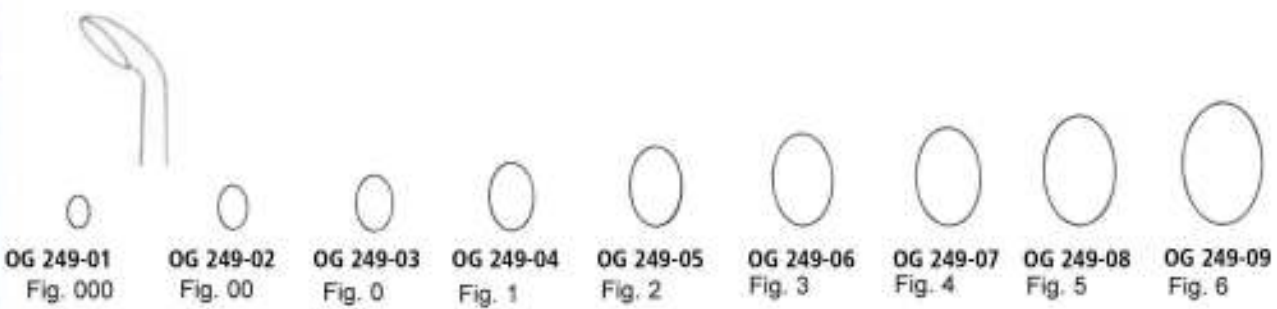
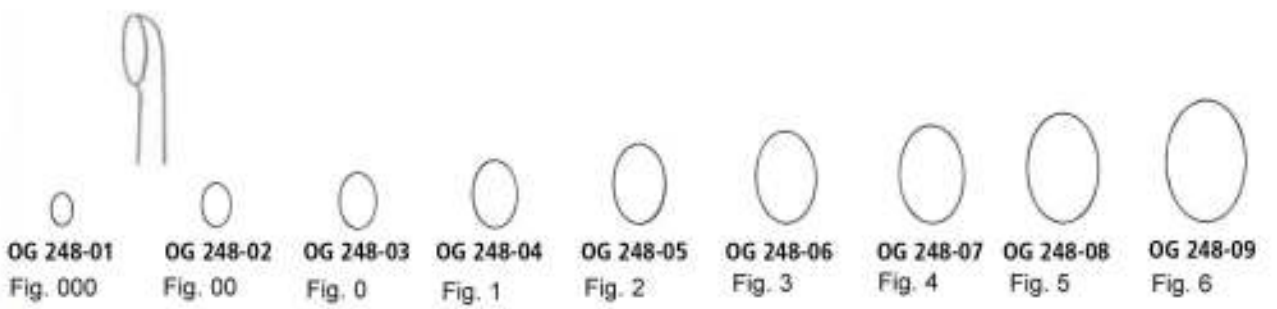

Kemik Küretleri
Bone Curettes
Scharfe Löffel



1/2
BRUNS
17 cm/6¾"



OG 250-01
Fig. 000



OG 250-02
Fig. 00



OG 250-03
Fig. 0



OG 251-01
Fig. 1



OG 251-02
Fig. 2



OG 251-03
Fig. 3



OG 251-04
Fig. 4



1/2
SCHEDE
17 cm/6¾"



OG 252-01
Fig. 000



OG 252-02
Fig. 00



OG 252-03
Fig. 0



OG 253-01
Fig. 1



OG 253-02
Fig. 2



OG 253-03
Fig. 3



OG 253-04
Fig. 4



1/2
VOLKMANN
17 cm/6¾"



OG 254-01
Fig. 0000



OG 254-02
Fig. 000



OG 254-03
Fig. 00



OG 254-04
Fig. 0



OG 254-05
Fig. 1



OG 255-01
Fig. 2



OG 255-02
Fig. 3



OG 255-03
Fig. 4



OG 255-04
Fig. 5



OG 255-05
Fig. 6



WILLIGER
17 cm



OG 256-01
3.4 mm



OG 256-02
5.2 mm

Kemik Küretleri
Bone Curettes
Scharfe Löffel



Kemik Küretleri
Bone Currettes
Scharfe Löffel





5 mm	OG 276-05
10 mm	OG 276-10
15 mm	OG 276-15
20 mm	OG 276-20
25 mm	OG 276-25

LAMBOTTE
21 cm/8¼"



WILLIGER
OG 277-01
13 cm/5"



WILLIGER
OG 277-02
16 cm/6¼"

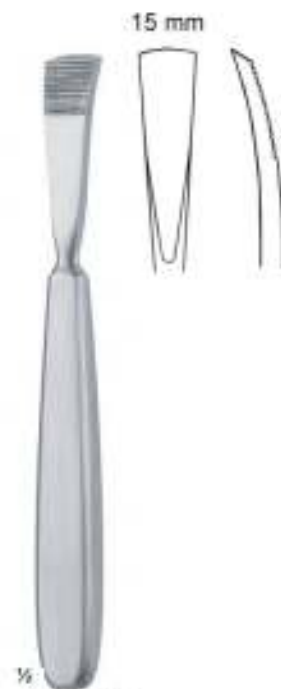

JANSEN
OG 277-16
16,5 cm/6½"



KÖNIG
OG 278-15
15,5 cm

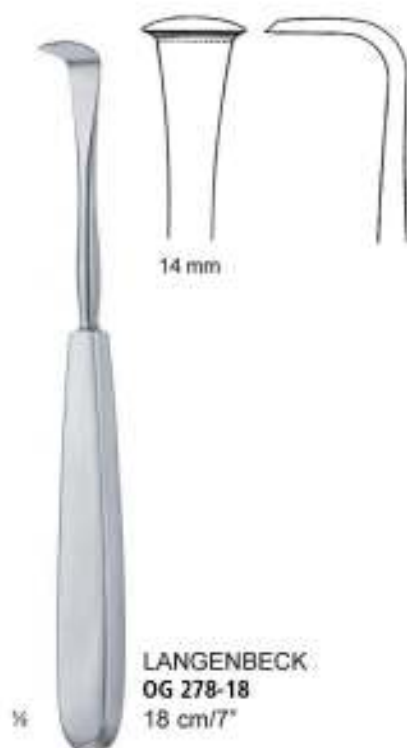

LANGENBECK
OG 278-18
18 cm/7"



LANGENBECK
OG 278-19
19,5 cm/7¾"

Raspalar
Raspatories
Raspatorien



⅓
JOSEPH
OG 279-17
16 cm/6¼"



⅓
FARABEUFG
OG 280-14
15 cm/5¾"



⅓
FARABEUFG
OG 281-14
15 cm/5¾"



⅓
FARABEUFG - COLLIN
OG 282-16
16 cm/6¼"

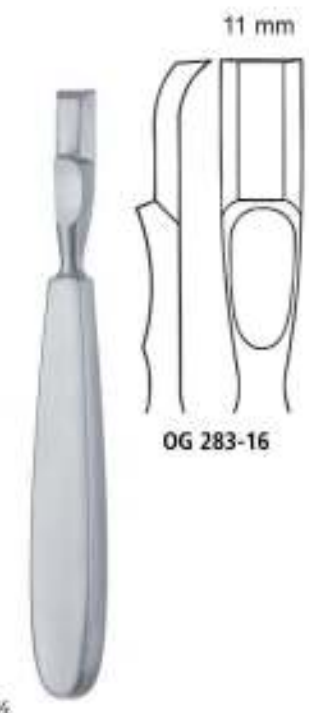

⅓
FARABEUFG - COLLIN
OG 283-16
16 cm/6¼"



⅓
SEDILLOT
OG 284-18
18,5 cm/7"



OG 286-19
19 cm/7½"



OG 286-18
18,5 cm/7¼"

⅓
KRÄMER

Raspalar
Raspatories
Raspatorien



1/2
SEDILLOT
OG 287-21
21 cm/8 1/4"



OG 288-01
6 mm

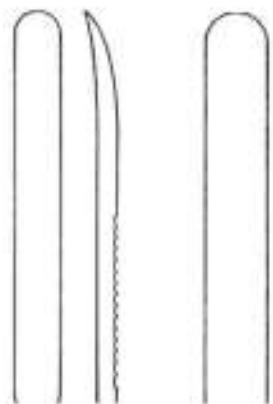

OG 288-02
8 mm



13 mm
1/2
SCHNEIDER
OG 289-13
17,5 cm/6 1/2"



14 mm
1/2
SCHNEIDER SAUERBR
OG 289-14
19 cm/7 1/2"



1/2
KEY
19 cm/7 1/2"

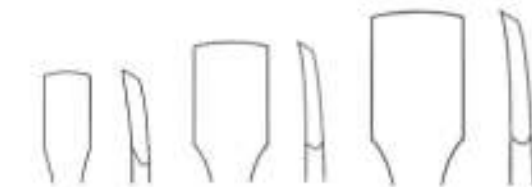

OG 290-6
6 mm

OG 290-10
10 mm

OG 290-12
12 mm

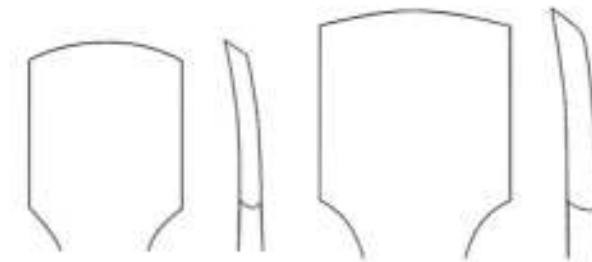

OG 290-19
19 mm

OG 290-25
25 mm

Raspalar
Raspatories
Raspatorien

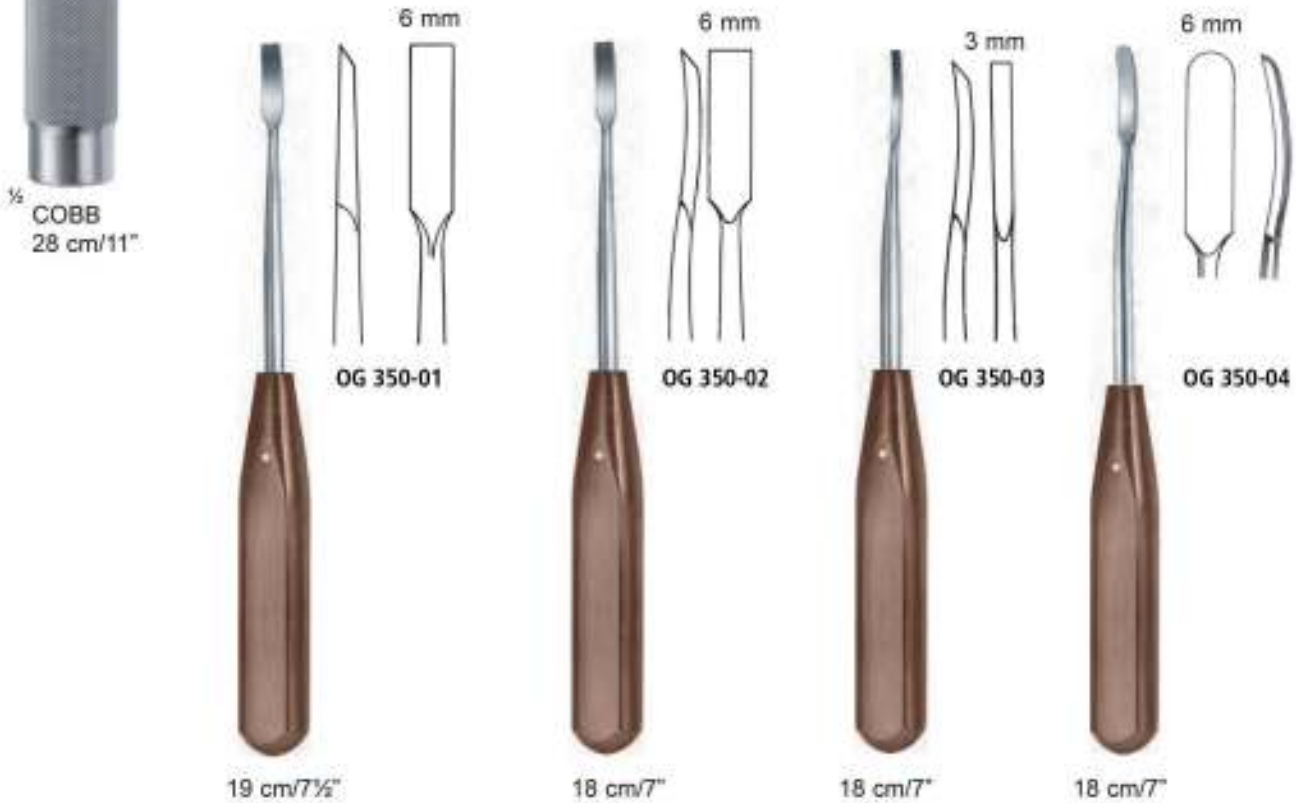
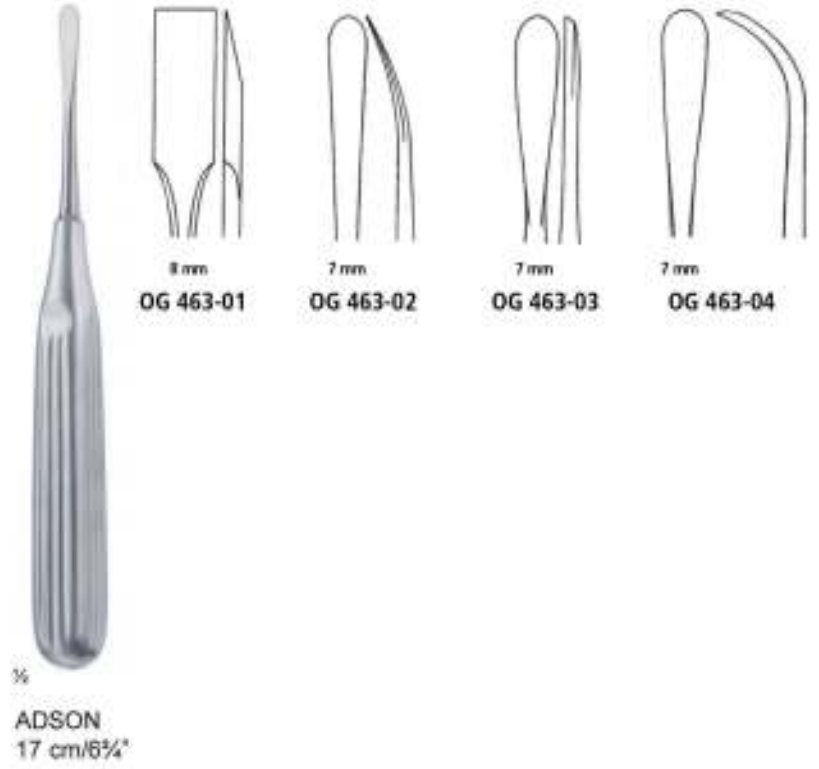



OG 351-01



20 cm/8"



14 mm

OG 351-02



20 cm/8"



OG 351-03



20 cm/8"



$\frac{3}{8}$
CASPAR
20 cm/8"

OG 354-01
ø 3 mm

OG 354-02
ø 5 mm

OG 354-03
ø 8 mm



$\frac{3}{8}$
20 cm/8"

OG 355-01
ø 12 mm

OG 355-02
ø 14 mm

OG 355-03
ø 16 mm

OG 358-01
ø 3 x 8 mm

OG 358-02
ø 4 x 10 mm

OG 358-03
ø 5 x 15 mm

OG 358-04
ø 6 x 20 mm



$\frac{3}{8}$

29 cm/11½"

Kemik Pensleri
Bone Holding Forceps
Knochenhaltezenge

iDOL
CERRAHİ ALETLER
www.idolcerrahi.com



OG 300-14
15 cm / 5 7/8"



OG 300-19
20 cm / 7 7/8"



OG 300-24
24 cm / 9 1/2"



OG 300-26
26 cm / 10 1/8"

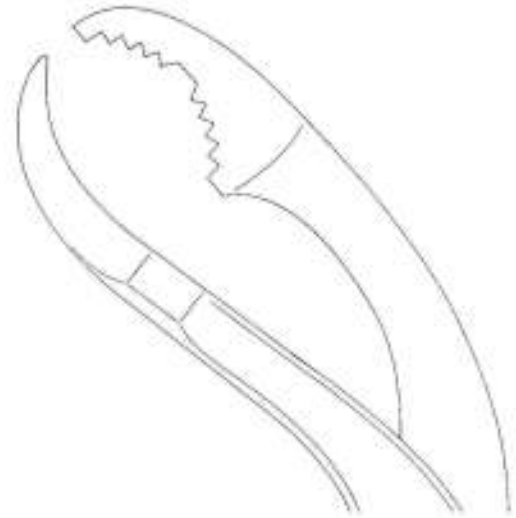

OG 300-28
28 cm / 11"



1/2

Kemik Pensleri
Bone Holding Forceps
Knochenhaltezen

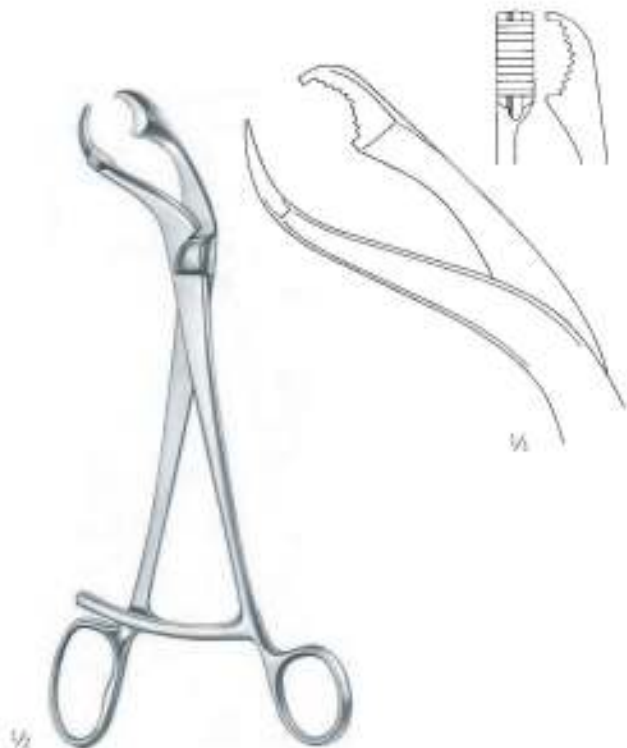

Verbrugge
OG 301-17
17,5 cm / 6 7/8"



Verbrugge

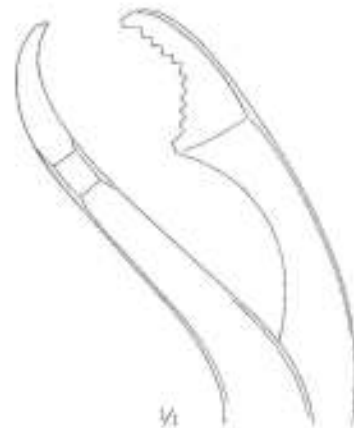

OG 302-01
25 cm / 9 7/8"

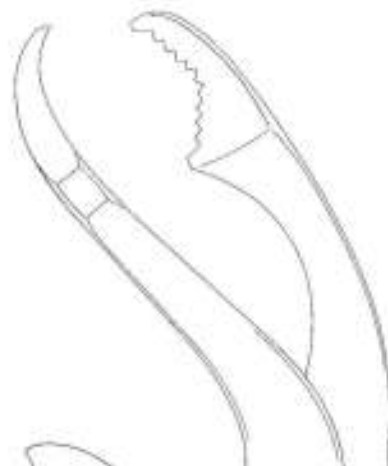

OG 302-02
26 cm / 10 1/8"



OG 302-03
27,5 cm / 10 3/4"

Kemik Pensleri
Bone Holding Forceps
Knochenhaltezenen

idOL
CERRAHİ ALETLER
www.idolcerrahi.com



KERN-MINI
OM 205-15
15.5 cm



KERN-LANE
OM 205-24
24 cm



LANE
OM 205-32
32 cm

Kemik Pensleri
Bone Holding Forceps
Knochenhaltezenen



Kemik Pensleri
Bone Holding Forceps
Knochenhaltezenen

idOL
CERRAHİ ALETLER
www.idolcerrahi.com

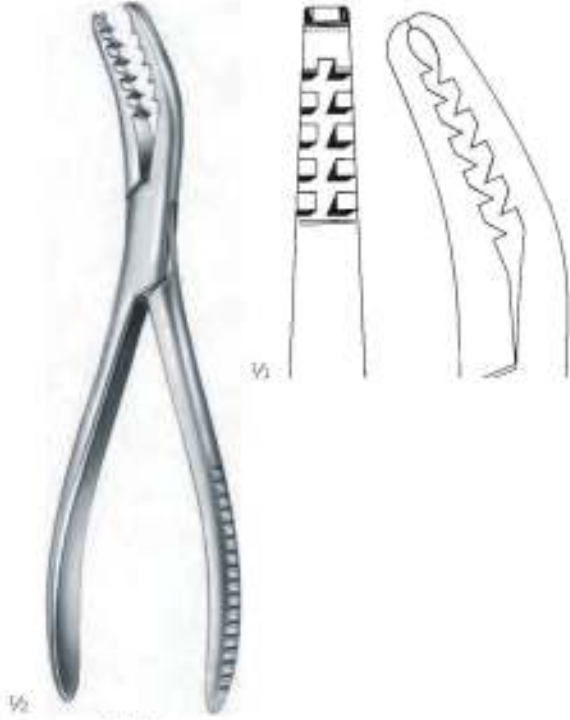

SEMB
OM 210-19
19 cm



SEMB
OM 211-19
19 cm



OM 231-14
14 cm



OM 231-17
17 cm



OM 231-23
23.5 cm

Kemik Pensleri
Bone Holding Forceps
Knochenhaltezenzen

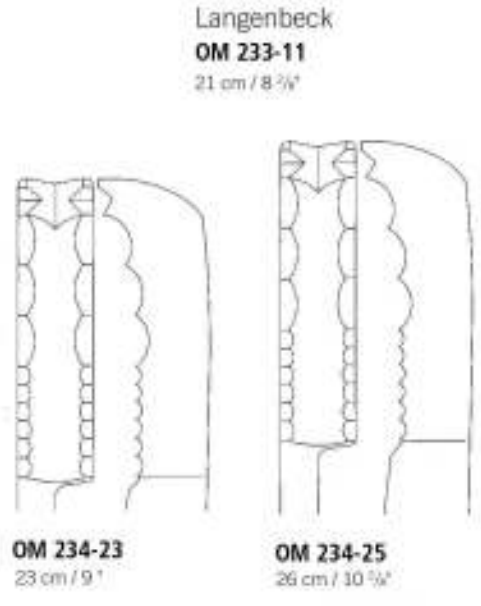
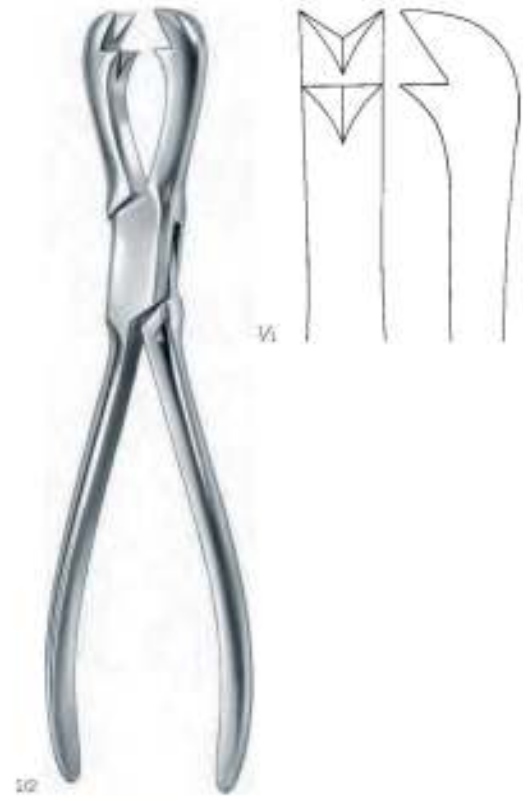

OM 234-23
23 cm / 9"

OM 234-25
26 cm / 10 3/8"

Langenbeck
OM 233-11
21 cm / 8 3/8"

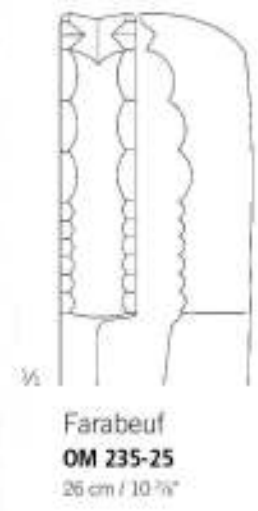

Farabeuf
OM 235-25
26 cm / 10 3/8"

Farabeuf

Kemik Pensleri
Bone Holding Forceps
Knochenhaltezenen

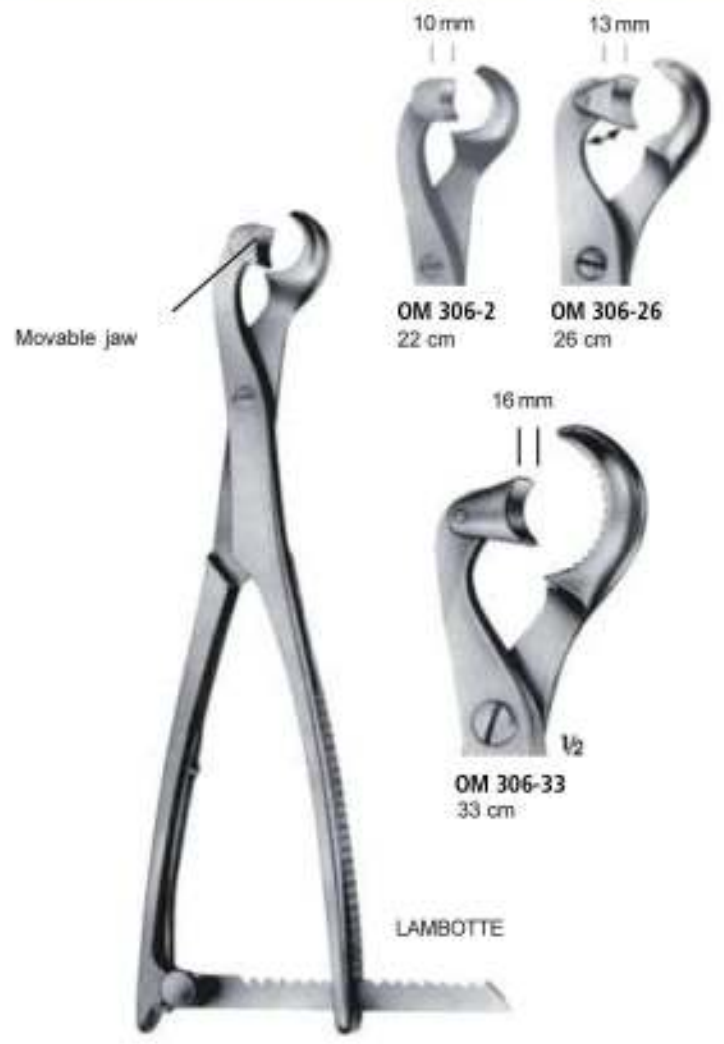

Kemik Pensleri
Bone Holding Forceps
Knochenhaltezenen



1/2

LOWMAN
OM 310-17 17 cm
OM 310-20 20.5 cm



1/2

LOWMAN - GERSTER
OM 311-21
21 cm



1/2

LOWMAN - HOGLUND
OM 312-17
17.5 cm

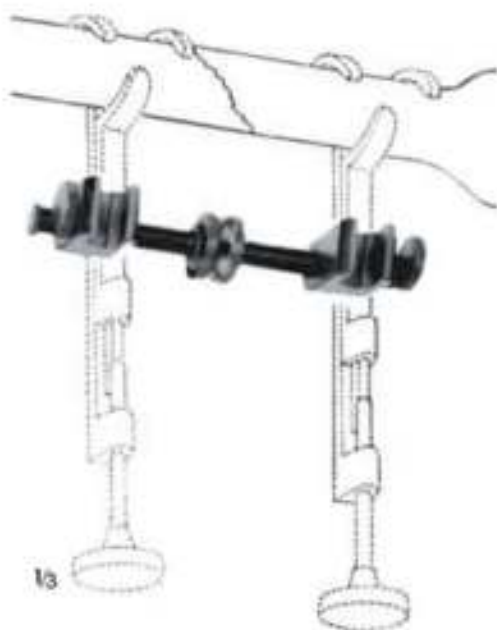

1/3

GERSTER
OM 313-0
Traction bar

Kemik Ronjurları
Bone Rongeurs
Hohlmeißelzangen

İDOL
CERRAHİ ALETLER
www.idolcerrahi.com

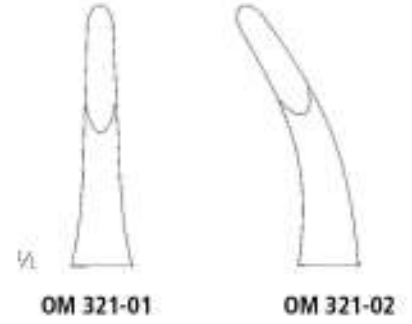

Kemik Ronjurları
Bone Rongeurs
Hohlmeißelzangen



OM 336-18

ZAUFAL JANSEN
18 cm/7"



OM 337-19

RUSKIN
18 cm/7"



OM 338-15

OM 339-15

BOEHLER
15 cm/5 3/4"



OM 338-24

RÖTTGEN-RUSKIN
23 cm/9"



OM 340-01

OM 340-02

LUER
17 cm/6 3/4"



OM 340-17

MAYFIELD
17 cm/6 3/4"

Kemik Ronjurları
Bone Rongeurs
Hohlmeißelzangen



OLIVECRONA
OM 344-20
20 cm/8"



GULEKE
OM 345-20
20,5 cm/8 1/4"



ECHLIN
23 cm/9"



FRYKHOLM
OM 352-24
24 cm/9 1/2"



STILLE
OM 353-23
23 cm/9"



STILLE RUSKIN
OM 355-24
23 cm/9"



STILLE LUER



OM 257-22
22 cm/8¾"



OM 358-22
22 cm/8¾"

Kemik Ronjurları
Bone Rongeurs
Hohlmeißelzangen

iDOL
CERRAHİ ALETLER
www.idolcerrahi.com



Kemik Kesme Pensleri
Bone Cutting Forceps
Knochensplitterzangen



OM 360-14
14 cm/5½"



OM 360-20
20 cm/8"



OM 360-17
17 cm/6¾"



OM 360-22
22 cm/8¾"

LISTON



OM 361-14
14 cm/5½"



OM 361-20
20 cm/8"



OM 361-17
17 cm/6¾"



OM 361-22
22 cm/8¾"

LISTON

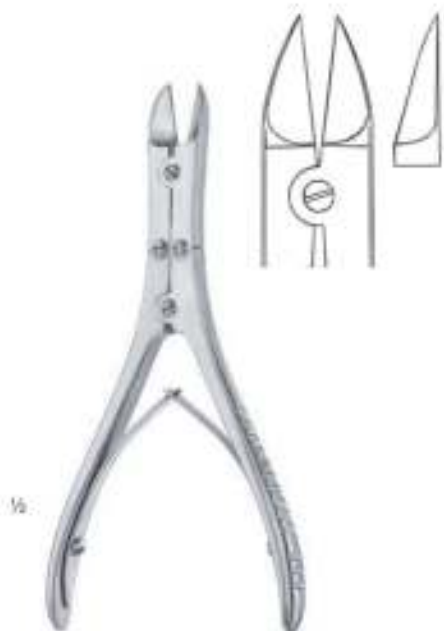

BOEHLER
OM 362-15
15 cm/5¾"



OM 363-19

RUSKIN LISTON
18 cm/7"

Kemik Kesme Pensleri
Bone Cutting Forceps
Knochensplitterzangen

iDOL
CERRAHİ ALETLER
www.idolcerrahi.com



STILLE LISTON



OM 365-24
23,5 cm/9¼"



OM 367-28
27,5 cm/10¾"



STILLE LISTON
OM 366-28
27,5 cm/10¾"

Kemik Kesme Pensleri
Bone Cutting Forceps
Knochensplitterzangen



1/2

STILLE HORSLEY
OM 369-25
27 cm/10½"



1/2

STILLE HORSLEY
OM 386-26
27 cm/10½"

Kemik Törpüleri
Bone Files and Rasps
Knochen-Feilen und-Raspeln

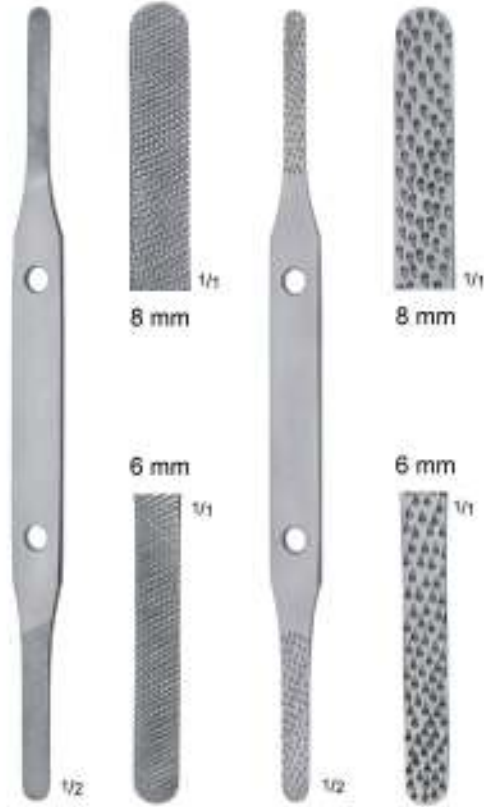

FOMON
KB 505-21
21 cm, 8¼"

FOMON
KB 506-21
21 cm, 8¼"



JOSEPH
17 cm, 6¾"



KB 507-16
8 mm

KB 508-16
8 mm



MALTZ
17 cm, 6¾"

KB 509-18
9 mm



FOMON
20 cm/8"



12/14 teeth
KB 515-01

16/20 teeth
KB 515-02

24/30 teeth
KB 515-03

30/44 teeth
KB 515-04

52/72 teeth
KB 515-05

Kemik Törpüleri
Bone Files and Rasps
Knochen-Feilen und-Raspeln

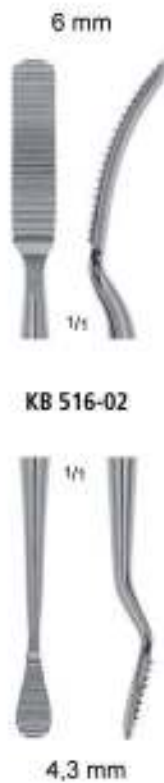
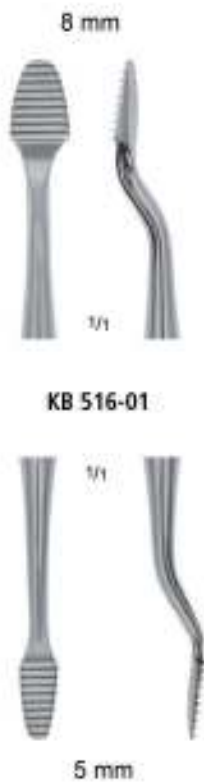

Kemik Törpüleri
Bone Files and Rasps
Knochen-Feilen und-Raspeln



OM 420-22
22 cm



OM 421-19
29.5 cm



OM 422-24
24 cm



PUTTI
OM 433-27
27 cm



PO 160-20
Right

HURD
21 cm

PO 161-20
Left



PO 164-27
Right

DESCHAMPS

PO 165-27
Left



PAYR
PO 200-22
19.5 cm



PAYR
PO 201-22
22.5 cm



KOCHER
PO -208-15
15 cm



KOCHER
PO 209-18
17 cm

Portegüler
Needle Holders
Nadelhalter

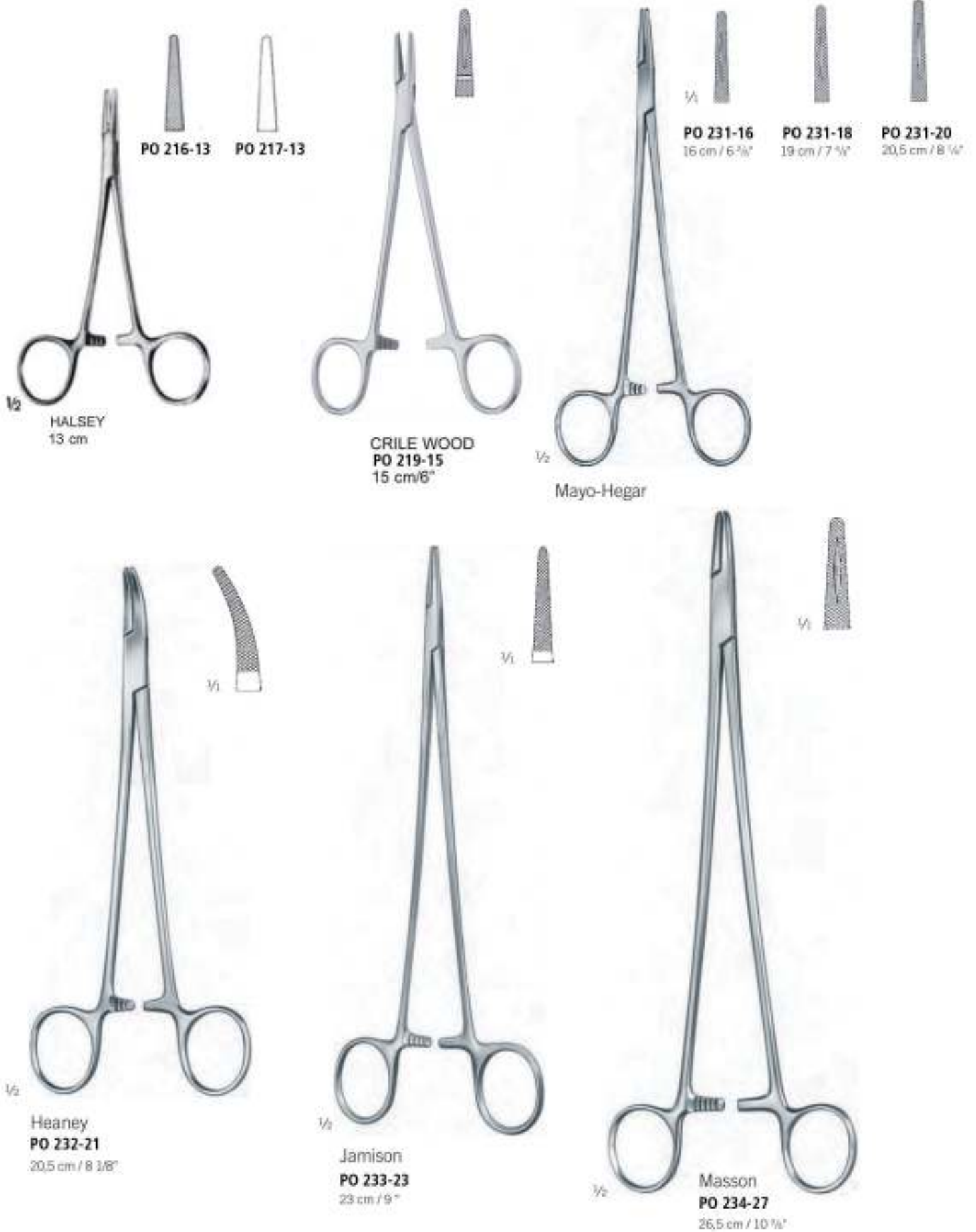

Portegüler
Needle Holders
Nadelhalter



MAYO HEGAR



PO 900-16
16 cm/6¼"



PO 900-18
18 cm/7"



PO 900-20
20 cm/8"



RYDER



PO 902-13
13 cm/5"



PO 902-18
18 cm/7"



PO 902-20
20 cm/8"

0,4



RYDER



PO 903-13
13 cm/5"



PO 903-15
15,5 cm/6"



PO 903-18
17,5 cm/7"



PO 903-20
20 cm/8"



MATHIEU



PO 926-14
14 cm/5½"



PO 926-17
17 cm/6¼"



PO 926-20
20 cm/8"

Portegüler
Needle Holders
Nadelhalter

iDOL
CERRAHİ ALETLER
www.idolcerrahi.com



PO 946-01
15 cm/6"



kräftiges Modell
heavy pattern
modèle fort
patrón pesados
pesanti pattern

PO 947-18
19 cm/7½"



PO 949-17
17 cm/6¾"

CASPAR

RG - 100 - 02 2 mm

RG - 100 - 03 3 mm

RG - 100 - 04 4 mm

RG - 100 - 05 5 mm

**150°****CASPAR**

RG - 101 - 02 2 mm

RG - 101 - 03 3 mm

RG - 101 - 04 4 mm

**150°****CASPAR**

RG - 102 - 02 2 mm

RG - 102 - 03 3 mm

RG - 102 - 04 4 mm



Ronjurlar
Rongeurs
Rongeurs

CASPAR

length of shaft	length of shaft	length of shaft	size of jaws
140 mm , 5 1/2"	160 mm , 6 1/4"	185 mm , 7 1/4"	
RG - 300 - 14	RG - 310 - 16	RG - 315 - 18	2 x 12 mm
RG - 301 - 14	RG - 311 - 16	RG - 316 - 18	3 x 12 mm
RG - 302 - 14	RG - 312 - 16	RG - 317 - 18	4 x 14 mm
	RG - 313 - 16	RG - 318 - 18	5 x 14 mm
	RG - 314 - 16	RG - 319 - 18	6 x 16 mm



150 °

CASPAR

length of shaft	length of shaft	length of shaft	size of jaws
140 mm , 5 1/2"	160 mm , 6 1/4"	185 mm , 7 1/4"	
RG - 330 - 14	RG - 335 - 16	RG - 340 - 18	3 x 12 mm
RG - 331 - 14	RG - 336 - 16	RG - 341 - 18	4 x 14 mm
	RG - 337 - 16	RG - 342 - 18	5 x 14 mm

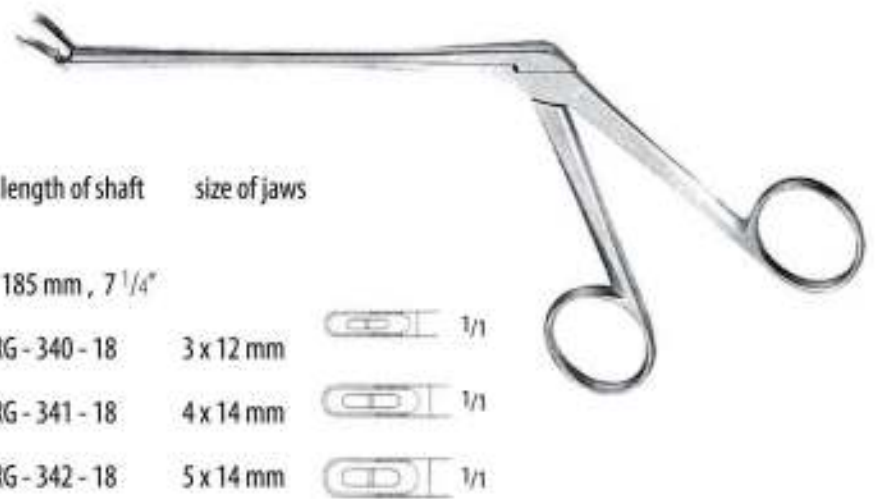

150 °

CASPAR

length of shaft	length of shaft	length of shaft	size of jaws
140 mm , 5 1/2"	160 mm , 6 1/4"	185 mm , 7 1/4"	
RG - 350 - 14	RG - 355 - 16	RG - 360 - 18	3 x 12 mm
RG - 351 - 14	RG - 356 - 16	RG - 361 - 18	4 x 14 mm

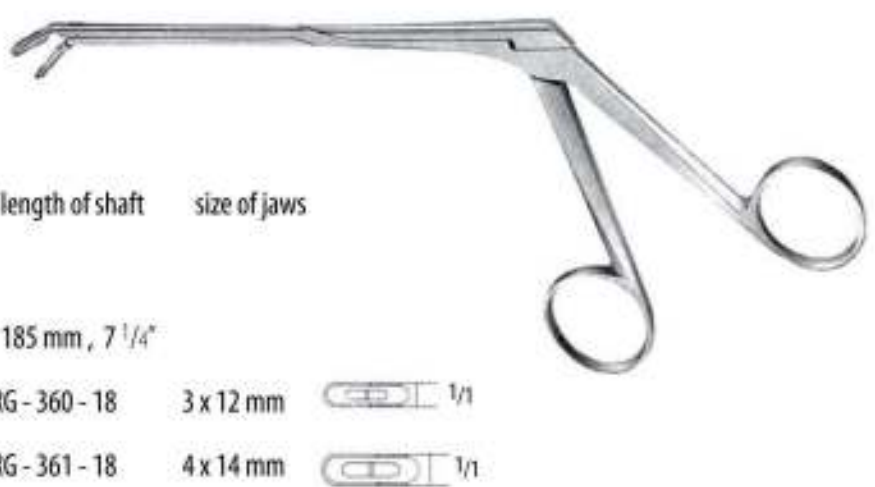



TAGER
YC 200-17
Bone lever for angle joint operations
17.5 cm



BENNETT
YC 201-23
23.5 cm



MURPHY - LANE
YC 202-34
34 cm

Kemik Elavatörleri
Bone Levers
Knochenheber



HOHMANN - ALDINGER

YC - 203 - 27
270 mm, 10³/₄"

SCHUMACHER mod. WAGNER

YC - 204 - 34
345 mm, 13¹/₂"

SCHUMACHER

YC - 205 - 29
290 mm, 11¹/₂"

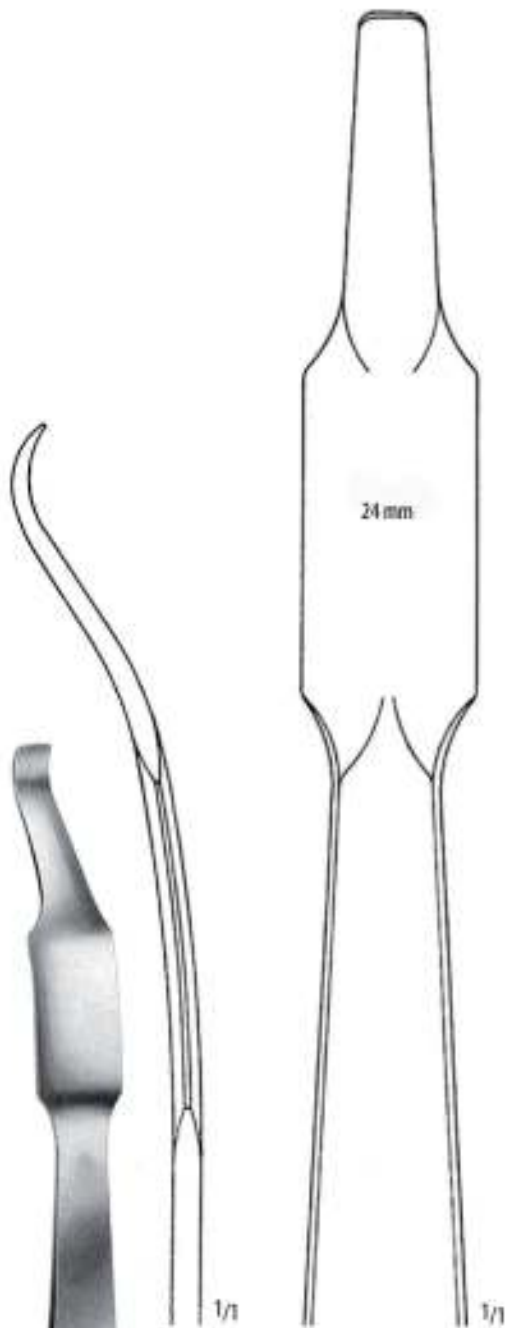

HOHMANN
YC - 206 - 26
260 mm, 10¹/₄"

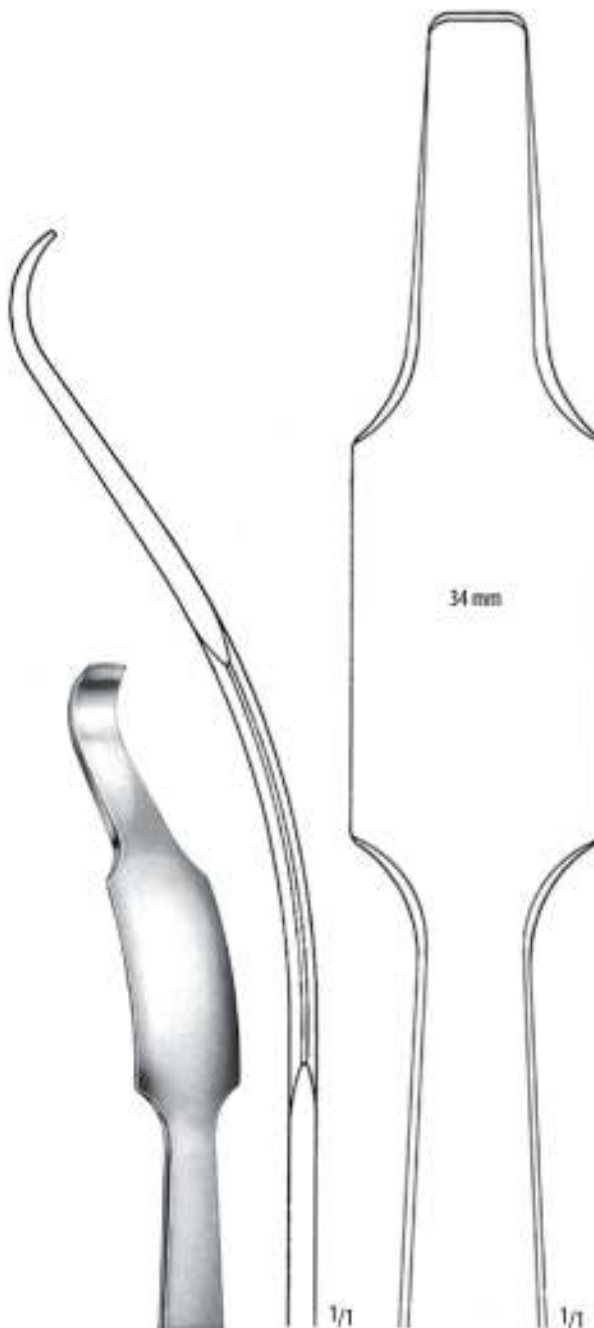

HOHMANN
YC - 207 - 28
285 mm, 11¹/₄"

Kemik Elavatörleri
Bone Levers
Knochenheber

iDOL
CERRAHİ ALETLER
www.idolcerrahi.com

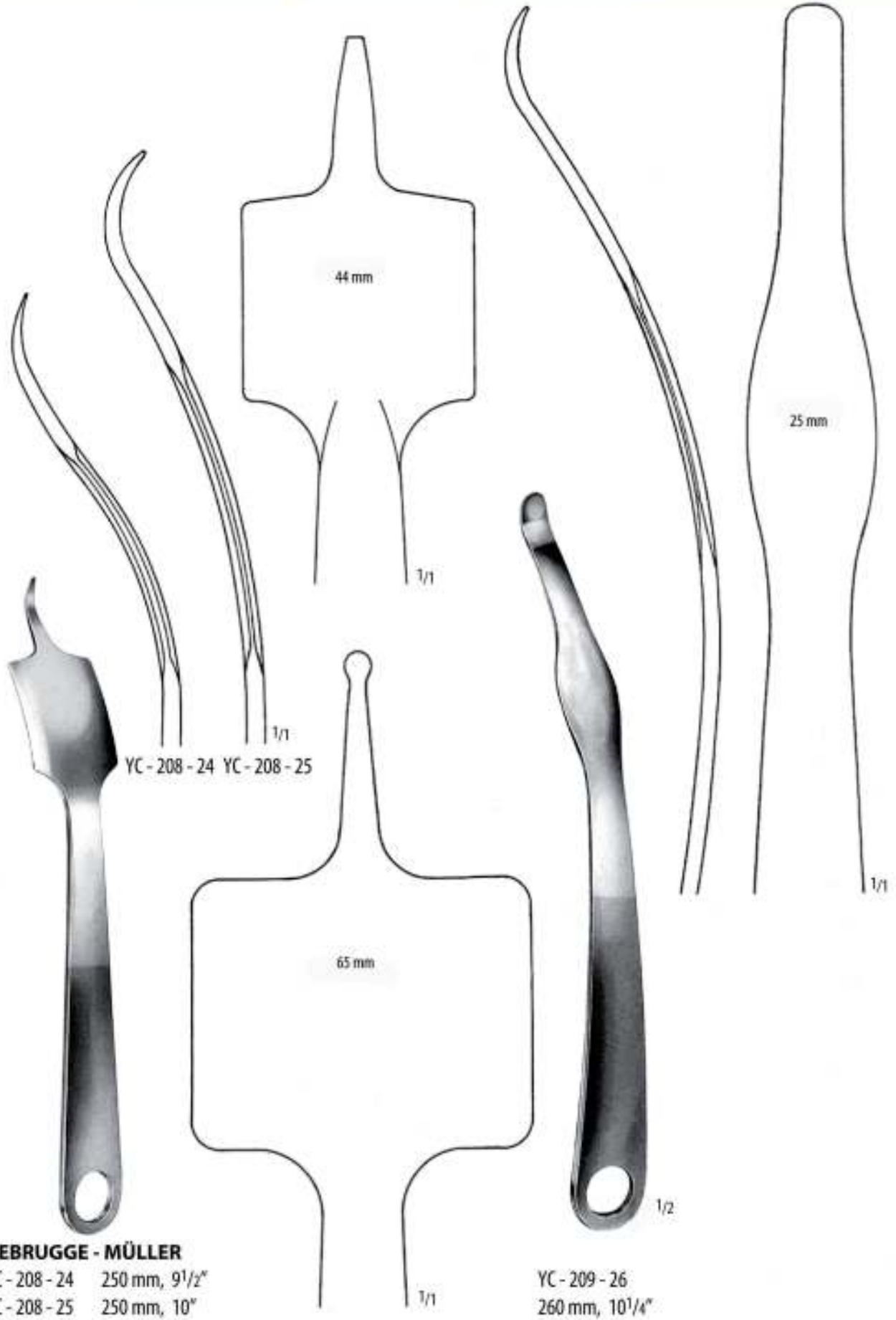

Kemik Elavatörleri
Bone Levers
Knochenheber

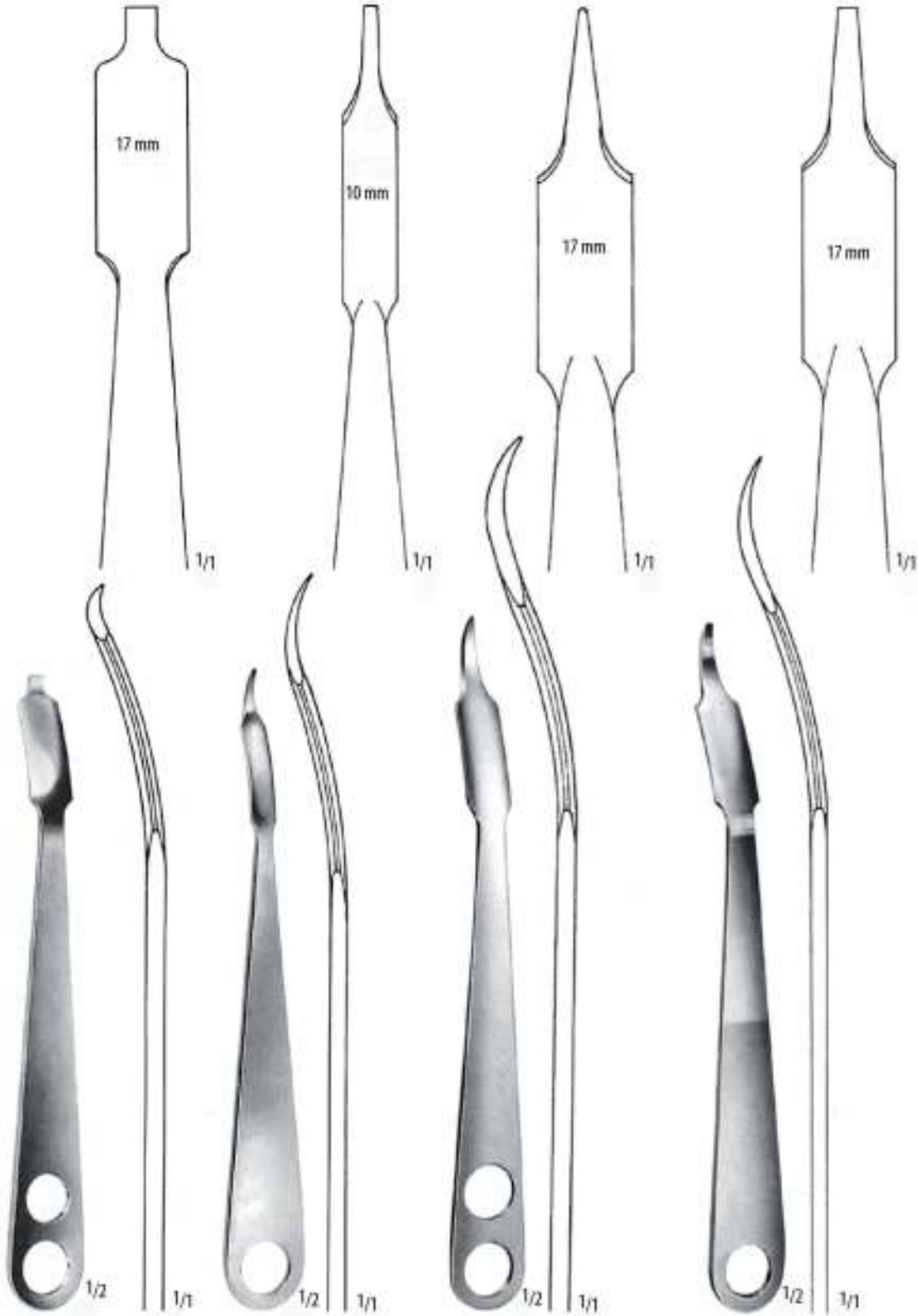

WAGNER
YC - 210 - 22
220 mm, 8³/₄"

YC - 211 - 22
220 mm, 8³/₄"

YC - 212 - 24
240 mm, 9¹/₂"

YC - 213 - 24
240 mm, 9¹/₂"

Kemik Elavatörleri
Bone Levers
Knochenheber

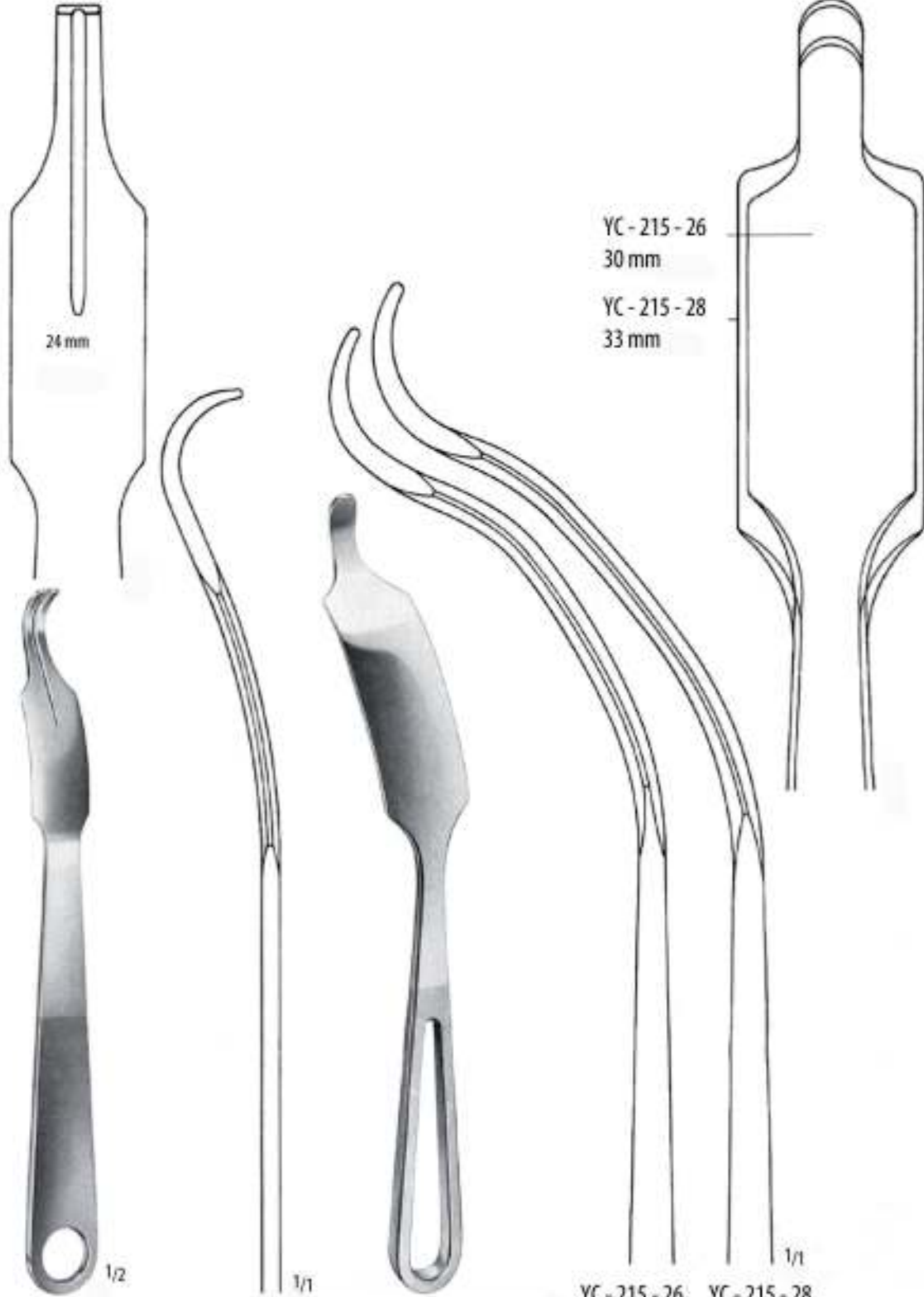

LANGE-HOHMANN
YC - 214 - 25
250 mm, 10"

LANGE-HOHMANN modif
YC - 215 - 26 265 mm, 10¹/₂"
YC - 215 - 28 280 mm, 11¹/₂"

YC - 215 - 26 YC - 215 - 28

Kemik Elavatörleri
Bone Levers
Knochenheber

