

iDOL

CERRAHİ ALETLER
SANAYİ VE TİCARET A.Ş.

BEYİN CERRAHİ
NEUROSURGEON
NEUROCHIRURGIE
BEYİN CERRAHİ
NEUROSURGEON
NEUROCHIRURGIE
BEYİN CERRAHİ
NEUROSURGEON
NEUROCHIRURGIE
BEYİN CERRAHİ
NEUROSURGEON
NEUROCHIRURGIE

Aspratör Uçları
Suction Tubes
Saugrohre

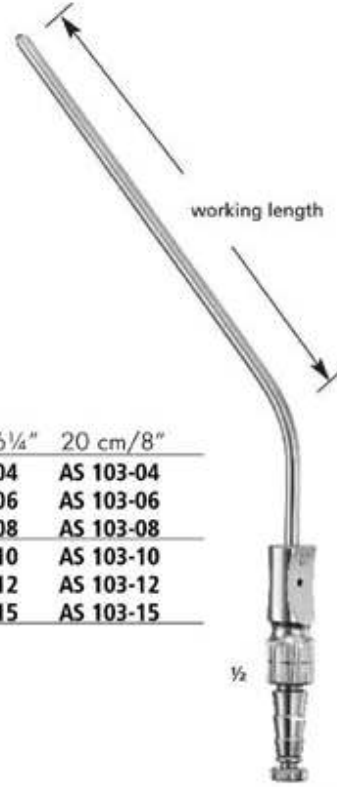

Ø mm	11 cm/4¼"	13 cm/5"	16 cm/6¼"	20 cm/8"
ø 1,5 mm	AS 100-04	AS 101-04	AS 102-04	AS 103-04
ø 2,0 mm	AS 100-06	AS 101-06	AS 102-06	AS 103-06
ø 2,5 mm	AS 100-08	AS 101-08	AS 102-08	AS 103-08
ø 3,0 mm	AS 100-10	AS 101-10	AS 102-10	AS 103-10
ø 4,0 mm	AS 100-12	AS 101-12	AS 102-12	AS 103-12
ø 5,0 mm	AS 100-15	AS 101-15	AS 102-15	AS 103-15

FERGUSSON

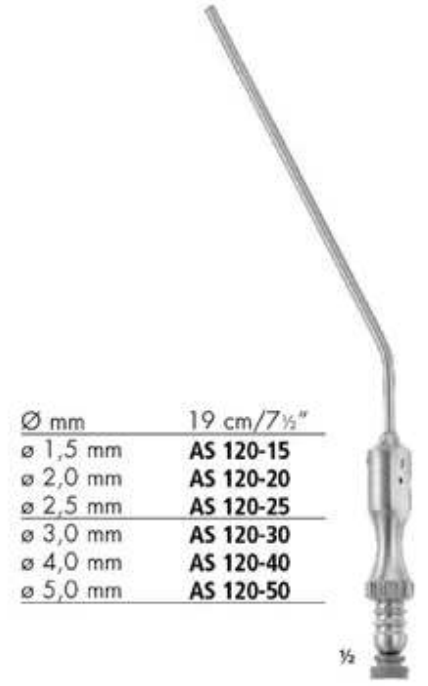

Ø mm	19 cm/7½"
ø 1,5 mm	AS 120-15
ø 2,0 mm	AS 120-20
ø 2,5 mm	AS 120-25
ø 3,0 mm	AS 120-30
ø 4,0 mm	AS 120-40
ø 5,0 mm	AS 120-50

FRAZIER



Ø mm	19 cm/7½"
ø 1,5 mm	AS 200-15
ø 2,0 mm	AS 200-20
ø 2,5 mm	AS 200-25
ø 3,0 mm	AS 200-30

PLESTER



Ø mm	13 cm/5"
ø 2,0 mm	AS 201-02
ø 3,0 mm	AS 201-03
ø 4,0 mm	AS 201-04
ø 5,0 mm	AS 201-05

FRAZIER



FERGUSSON
AS 250-12
18 cm/7"



AS 270-01

ø 1,0 mm

AS 270-02

ø 1,5 mm

AS 270-03

ø 2,0 mm

1/2

BARON



AS 300-00

14 cm/5 1/2"

Komplett
complete

AS 300-01

Suction Handle

1/2

WULLSTEIN

Mikro-Saugkanüle
Micro suction cannula



AS 300-02

4,5 cm/1 3/4"

ø 0,4 mm



AS 300-03

4,5 cm/1 3/4"

ø 0,6 mm



AS 300-04

4,5 cm/1 3/4"

ø 0,8 mm



AS 310-01

Saughandgriff
Suction Handle

AS 310-00

Komplett, mit Griff und 4 Ausfäßen
complete, with handle and 4 tips



ø 0,5 mm AS 310-02

ø 0,7 mm AS 310-03

ø 1,0 mm AS 310-04

ø 1,3 mm AS 310-05

Saugadapter ø 7 mm
Suction adapter ø 7 mm



HOUSE

AS 311-05

5,5 cm/2 1/4"



Präpariersauger
Suction raspatory

ø 3,2 mm

LANDOLT

AS 315-20

20 cm/8"

Aspratör Uçları
Suction Tubes
Saugrohre

← working length →

	ø 1,5 mm	ø 2,0 mm	ø 2,5 mm	ø 3,5 mm	ø 4,5 mm
13 cm/5"	AS-320-13	AS-321-13	AS-322-13	AS-323-13	
15 cm/6"	AS-320-15	AS-321-15	AS-322-15	AS-323-15	
18 cm/7"	AS-320-18	AS-321-18	AS-322-18	AS-323-18	AS-324-18
22 cm/8¾"	AS-320-22	AS-321-22	AS-322-22	AS-323-22	

LUER
½

Olive ø 6,5 - 9 mm
YASARGIL

ø 9 mm



DE BAKEY
AS-352-27
28 cm/11"

ø 10 mm



YANKAUER
AS-355-27
27 cm/10¾"

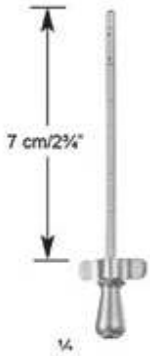

ø 2,0 mm AS 500-20
ø 2,5 mm AS 500-25



FRAZIER
12 cm/4 3/4"
ø 2,0 mm AS 501-20
ø 2,5 mm AS 501-25
ø 3,0 mm AS 501-30

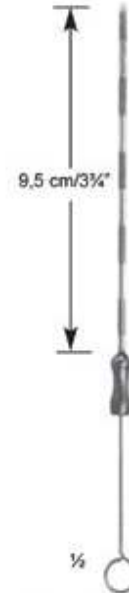

CUSHING-CAIRNS
ø 2,3 mm AS 502-23
ø 2,6 mm AS 502-26

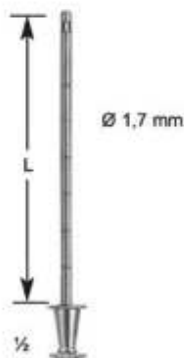

JEFFERSON
8 cm/3 1/4" AS 503-08
10 cm/4" AS 503-10

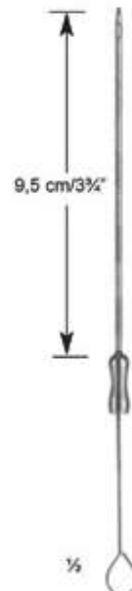

DANDY
ø 2,0 mm AS 504-20

Jilet Tutucular
Razor Blade Breaker and Holders
Rasierklingen-Brecher und -Halter



TROUTMAN-CHRIS
BS 165-09
9 cm/3½"



TROUTMAN-CHRIS
BS 166-09
9 cm/3½"



CASTROVIEJO
BS 165-13
13 cm/5"



BS 167-11
11 cm/4¼"



CASTROVIEJO
BS 169-18
18 cm/7"



BS 200-03
12 cm/4¾"
No. 3

massiv, mit Zentimeter
solid, cm



BS 200-04
13,5 cm/5¼"
Fig. 4



BS 201-03
12 cm/4¾"
Fig. 3



BS 201-04
13,5 cm/5¼"
Fig. 4



BS 202-13
21,5 cm/8½"
Fig. 3 L



BS 203-14
21 cm/8¼"
Fig. 4 L



BS 209-07
22 cm/8¾"
Fig. 7 L



BS 210-07
16 cm/6¼"
Fig. 7



BS 211-07
12,5 cm/5"
Fig. 7 K



BS 220-21
21 cm/8¼"
Fig. 3 L



BS 221-21
21 cm/8¼"
Fig. 4 L



BS 230-16
16 cm/6¼"
No. 5



BS 231-21
21,5 cm/8½"
No. 5



BS 232-21
21 cm/8¼"
No. 5

Bisturi Sapları
Scalpel Handles
Skalpellgriffe

rund
round



BS 240-01
14,5 cm/5¾"
Fig. 3 R

rund, abgewinkelt
round, angled



BS 240-02
14 cm/5½"
Fig. 3 R



BS 241-21
21 cm/8¼"



BS 242-01
13,5 cm/5¼"



BS 242-02
15,5 cm/6"



BS 242-03
18 cm/7"



BS 242-04
20 cm/8"



LANDOLT
BS 243-21
21 cm/8¼"



LANDOLT
BS 244-25
25 cm/10"

Dura ve Cilt Ekartörleri
Fine Wound Retractors
Feine Wundhäkchen



EK 120-13
13 cm/5"
spitz
sharp

FRAZIER



EK 125-15
15 cm/6"
spitz
sharp

TOENNIS



EK 130-15
15 cm/6"
spitz
sharp

FREER



8,0 mm
EK 150-01
23 cm/9"

SCOVILLE



7,0 mm
EK 150-02
24 cm/9½"

HOLSCHER



7,0 mm
EK 150-03
19 cm/7½"

SCOVILLE

**Ekartörler
 Retractors
 Wundhaken**



EK 207-01
 JOSEPH
 16 cm/6¼"
 spitz sharp



EK 207-02
 2 mm
 JOSEPH
 16 cm/6¼"
 spitz sharp



EK 207-03
 5 mm



EK 207-04
 7 mm



EK 207-05
 10 mm



8 x 4 mm
15 x 5,5 mm
 RAGNELL-DAVIS
 EK 226-14
 14 cm/5½"



1/2
 TAYLOR
 16 cm/6¼"

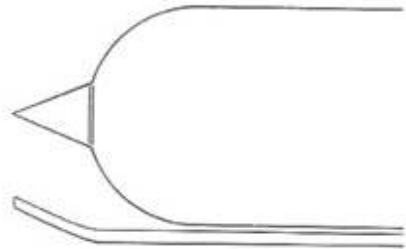

EK 228-07
 75 x 30 mm

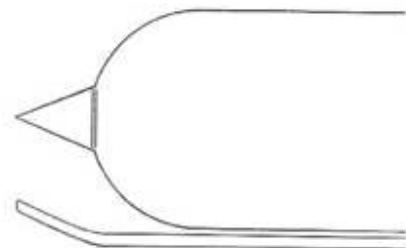

EK 228-10
 100 x 30 mm

Ekartörler
Retractors
Wundhaken



KOCHER-LANGENBECK
22 cm/8½"



EK 355-01
25x6 mm



EK 355-02
35x8 mm



EK 355-03
35x11 mm



EK 355-04
35x15 mm



EK 355-05
40x11 mm

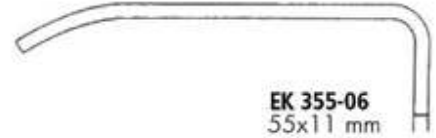

EK 355-06
55x11 mm



EK 355-07
70x14 mm



EK 355-08
80x12 mm



EK 355-09
80x16 mm



MEYERDING

90 x 50 mm

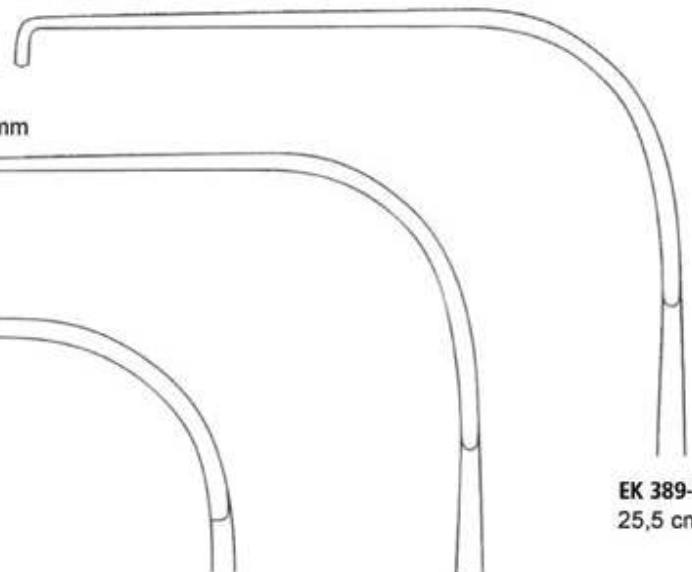

EK 389-50
25,5 cm/10"

75 x 25 mm

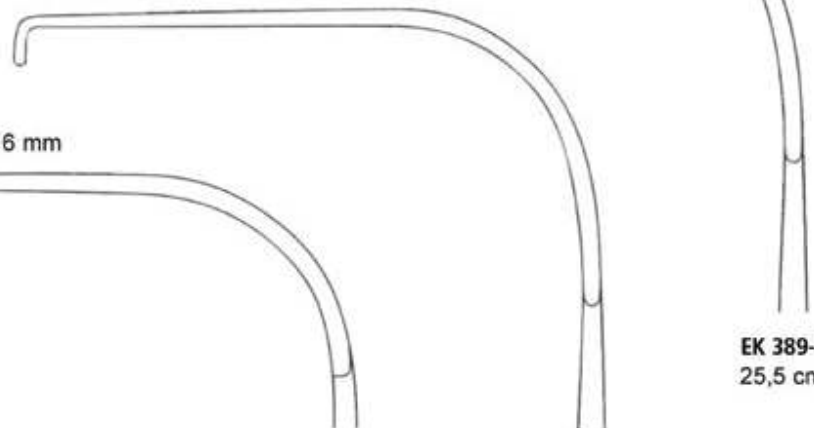

EK 389-25
24 cm/9½"

50 x 16 mm

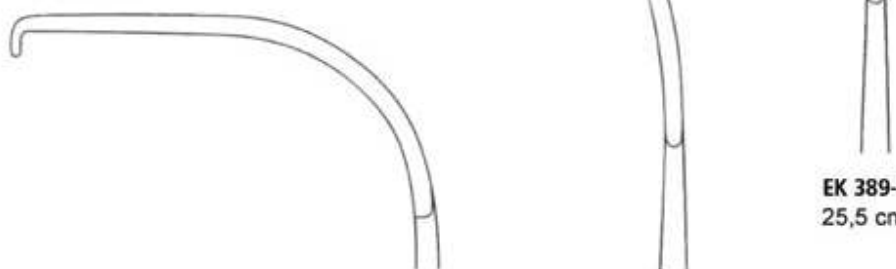

EK 389-16
23 cm/9"



FINSEN



EK 420-05
 5 cm/2"
 sharp



EK 421-05
 5 cm/2"
 blunt



EK 420-07
 7 cm/2¾"
 sharp



EK 421-07
 7 cm/2¾"
 blunt



EK 423-10
 spitz
 sharp
 4 x 4
 6 mm

10 cm/4"



½
 ALM



EK 424-07
 7 cm/2¾"
 sharp

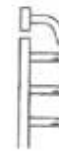

EK 424-10
 10 cm/4"
 sharp



EK 425-07
 7 cm/2¾"
 blunt



EK 425-10
 10 cm/4"
 blunt

3 x 3



EK 428-01
 spitz
 sharp

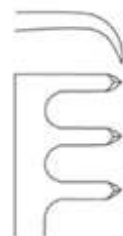

EK 428-02
 stumpf
 blunt

JANSEN
 10 cm/4"

4 x 4



EK 428-10
 spitz
 sharp

EK 429-10
 stumpf
 blunt

JANSEN
 10,5 cm/4¼"

Otomatik Ekartörler
Self Retaining Retractors
Wundspreizer



EK 432-14
13,5 cm/5¼"

WEITLANER



WEITLANER



EK 433-13

scharf
sharp



EK 434-13

stumpf
blunt

13 cm/5"



WEITLANER

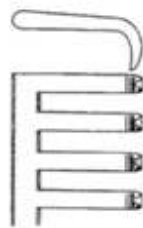

EK 435-13
14 cm/5½"
3 : 4
scharf
sharp

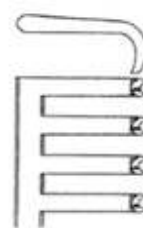

EK 436-13
14 cm/4½"
3 : 4
stumpf
blunt

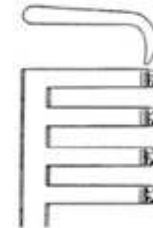

EK 435-16
16,5 cm/6½"
3 : 4
scharf
sharp

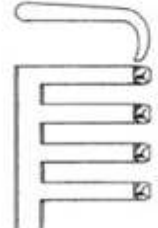

EK 436-16
16,5 cm/6½"
3 : 4
stumpf
blunt



WEITLANER
20 cm/8"

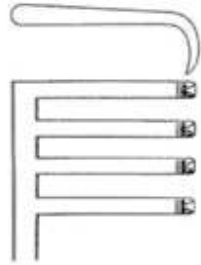

EK 435-20
3 : 4
scharf
sharp

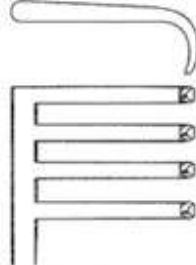

EK 436-20
3 : 4
stumpf
blunt



WEITLANER
25 cm/10"

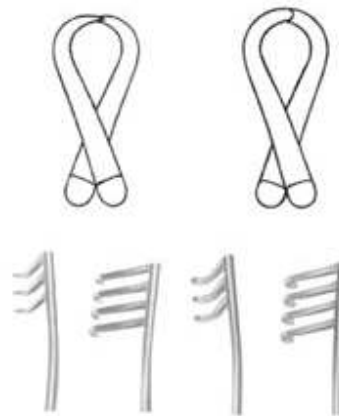

EK 435-25
3 : 4
scharf
sharp

EK 436-25
3 : 4
stumpf
blunt

Otomatik Ekartörler
Self Retaining Retractors
Wundspreizer



WEITLANER
 26 cm/10¼"

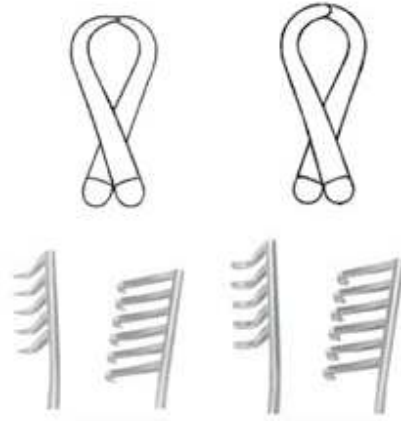

EK 435-26
 5 : 6
 scharf
 sharp

EK 436-26
 5 : 6
 stumpf
 blunt



HENLEY
 16,5 cm/6½"

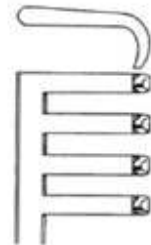

EK 437-00
 3 : 4
 stumpf
 blunt

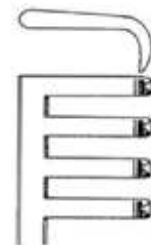

EK 438-00
 3 : 4
 scharf
 sharp



EK 437-19
 16x19 mm
 ⅝" x ¾"



EK 437-25
 16x25 mm
 ⅝" x 1"



EK 437-32
 16x32 mm
 ⅝" x 1¼"



MOLLISON
 15 cm/6"



EK 446-15
 scharf
 sharp



EK 447-15
 stumpf
 blunt

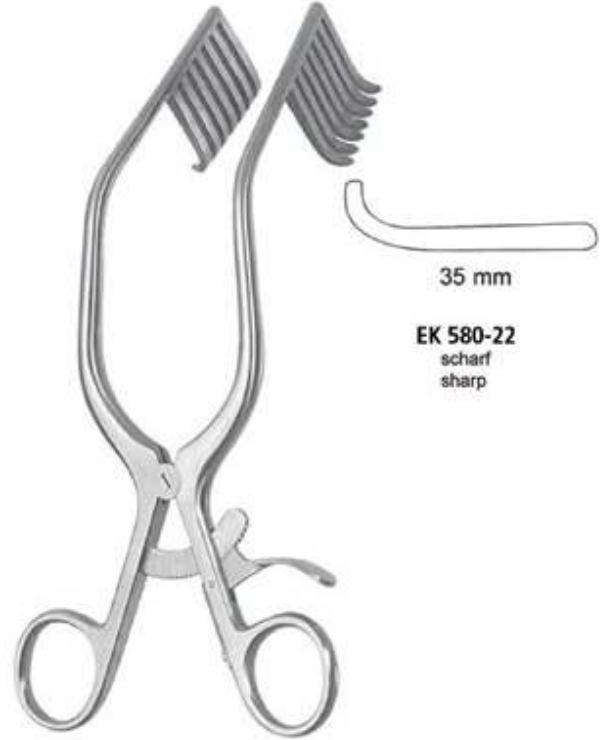

MISKIMON
 22 cm/8 1/4"

35 mm

EK 580-22
 scharf
 sharp



ADSON
 19 cm/7 1/2"

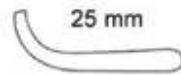

EK 450-20
 scharf
 sharp

EK 451-20
 stumpf
 blunt



ANDERSON-ADSON
 20 cm/8"

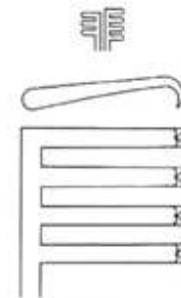

EK 452-20
 4 : 4
 scharf
 sharp



EK 453-20
 4 : 4
 stumpf
 blunt

Laminektomi Otomatik Ekartörleri
Self Retaining Laminectomy Retractors
Laminektomie-Wundspreizer

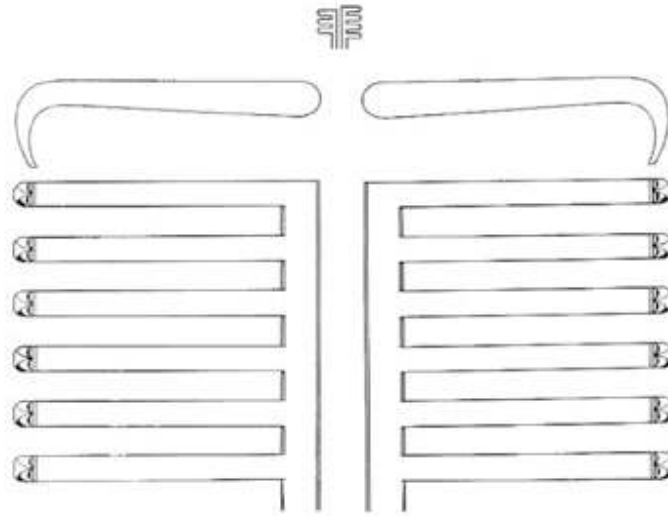

EK 456-27

6 : 6
scharf
sharp



26,5 cm/10½"

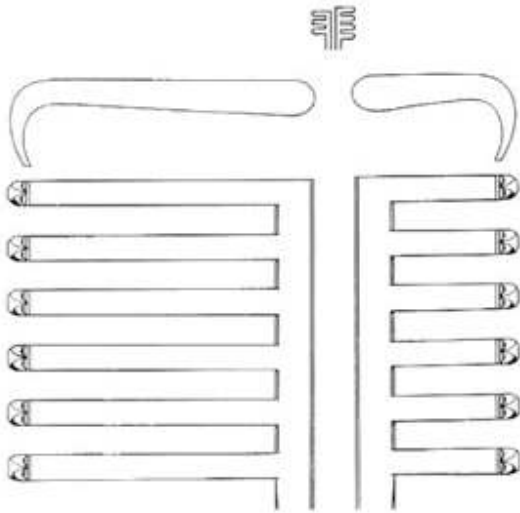

EK 457-01

6 : 6

scharf, lange Zähne links
sharp, long teeth on left side

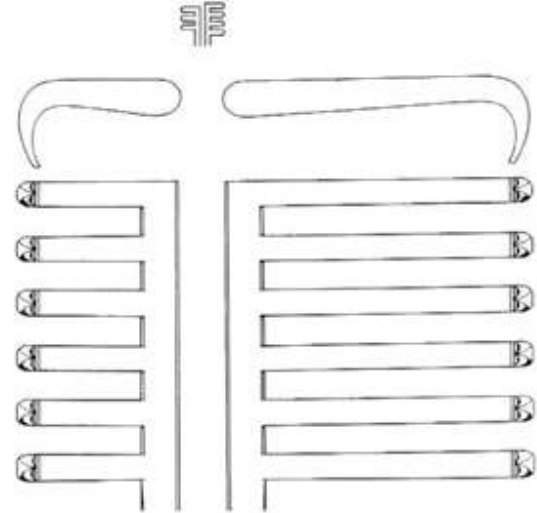

EK 457-02

6 : 6

scharf, lange Zähne rechts
sharp, long teeth on right side



26,5 cm/10½"

Otomatik Ekartörler
 Self Retaining Retractors
 Wundspreizer



ADSON
 3 : 4

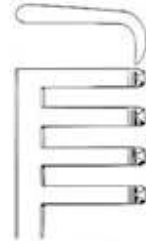

EK 458-13
 13,5 cm/5¼"



EK 459-13
 13,5 cm/5¼"



EK 458-16
 16,5 cm/6½"

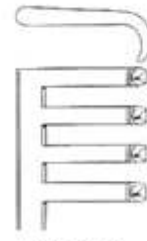

EK 459-16
 16,5 cm/6½"

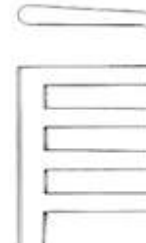

EK 458-20
 21 cm/8¼"



EK 459-20
 20 cm/8"



EK 458-25
 24,5 cm/9¾"
 scharf
 sharp



EK 459-25
 24,5 cm/9¾"
 stumpf
 blunt



← 150 mm →

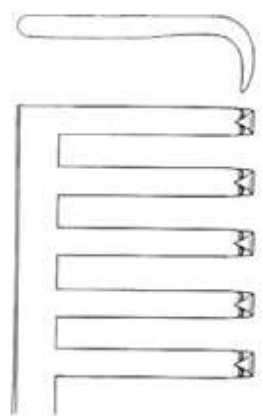

EK 460-31
4 : 5
scharf
sharp

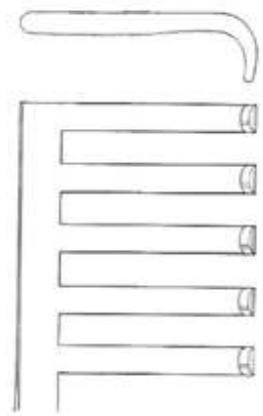

EK 461-31
4 : 5
stumpf
blunt

BECKMANN-ADSON
32 cm/12 3/4"

Laminektomi Otomatik Ekartörleri
Self Retaining Laminectomy Retractors
Laminektomie-Wundspreizer



BECKMANN-ADSON
30,5 cm/30¼"

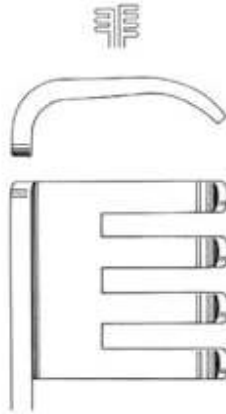

EK 464-01
30 mm
4 : 4
stumpf
blunt

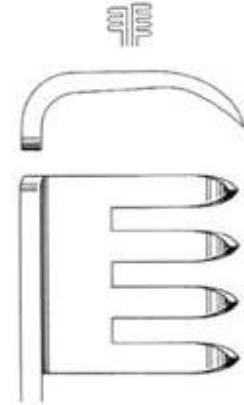

EK 465-01
30 mm
4 : 4
scharf
sharp

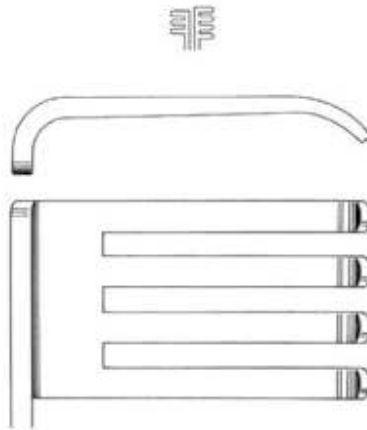

EK 464-03
50 mm
4 : 4
stumpf
blunt

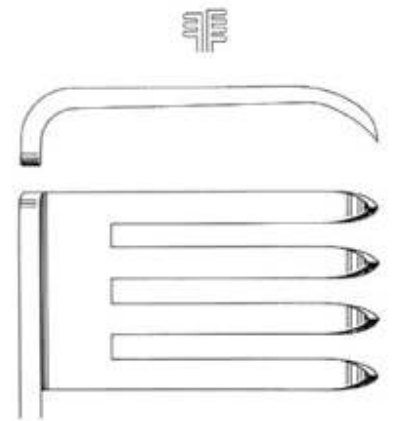

EK 465-03
50 mm
4 : 4
scharf
sharp



BECKMANN
31 cm/30½"

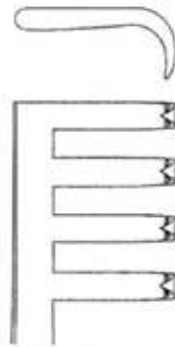

EK 464-02
4 : 4
scharf
sharp

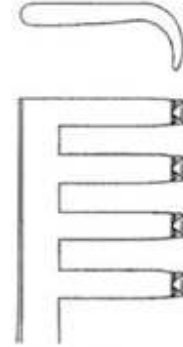

EK 465-02
4 : 4
halbscharf
semi-sharp

Laminektomi Otomatik Ekartörleri
 Self Retaining Laminectomy Retractors
 Laminektomie-Wundspreizer



EK 466-33
 7 : 7
 scharf
 sharp



BECKMANN-EATON
 32 cm/12¾"



GELPI

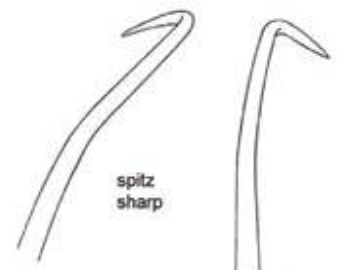

9 cm/3½"	EK 469-09
11 cm/4¼"	EK 469-11
14 cm/5½"	EK 469-14
18 cm/7"	EK 469-19

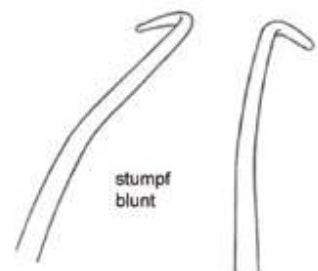

18 cm/7"	EK 470-19
----------	------------------



MEYERDING

32 x 25 mm	EK 474-01
54 x 25 mm	EK 474-02
60 x 19 mm	EK 474-03
60 x 25 mm	EK 474-04



MARKHAM-MEYERDING

EK 472-01
18 cm/7"

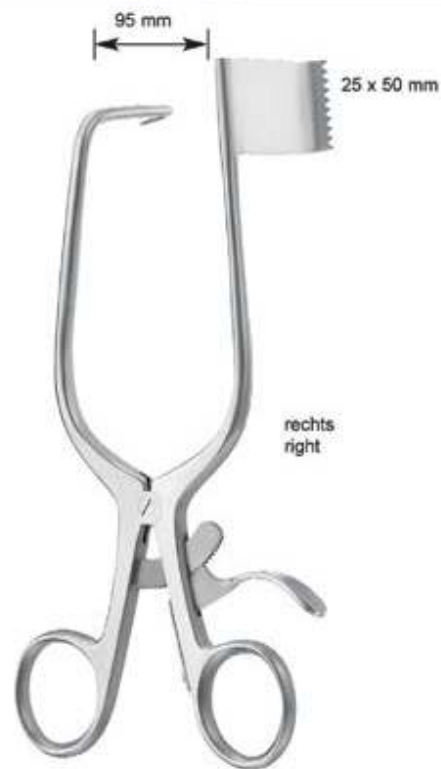

MARKHAM-MEYERDING

EK 472-02
18 cm/7"



DARLING
EK 474-01
18 cm/7"



DARLING
EK 474-02
18 cm/7"

Laminektomi Otomatik Ekartörleri
Self Retaining Laminectomy Retractors
Laminektomie-Wundspreizer

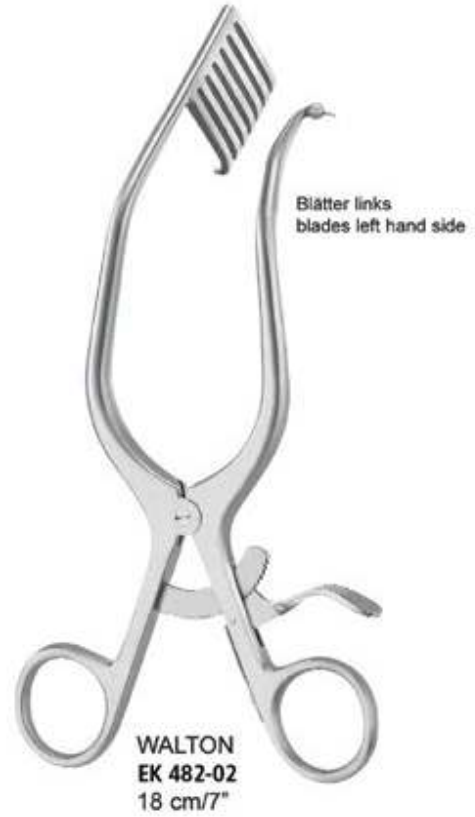

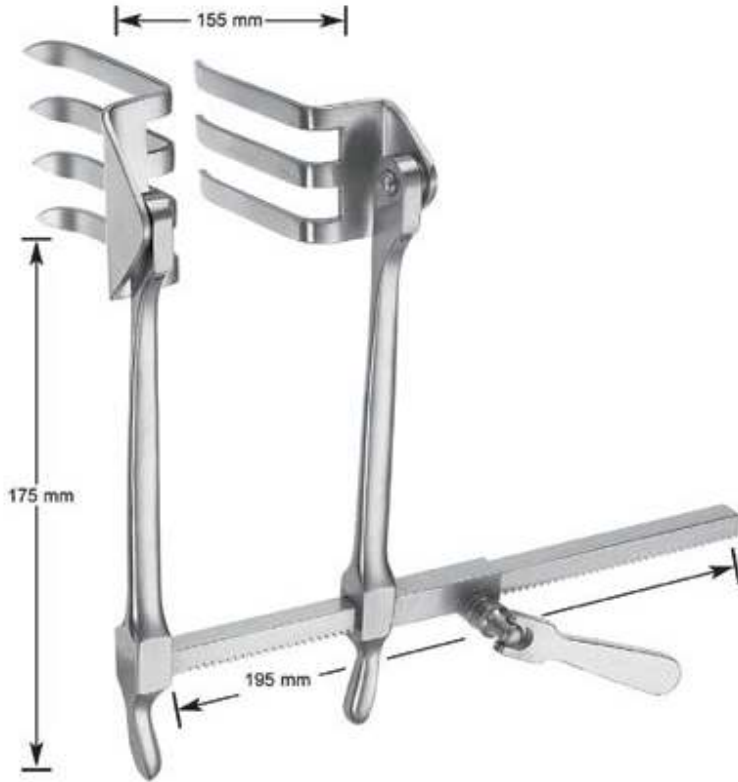

SCOVILLE-RICHTER
EK 617-00

Laminektomiespreizer komplett
Laminectomy retractor complete

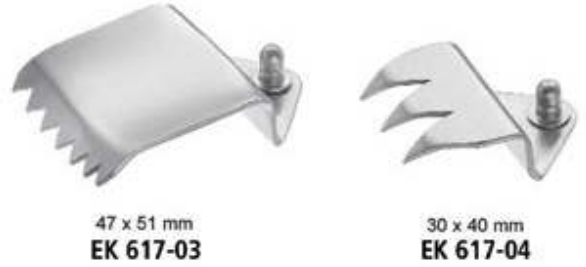

Laminektomi Otomatik Ekartörleri
Self Retaining Laminectomy Retractors
Laminektomie-Wundspreizer



TAYLOR	
47 x 37 mm	EK 671-01
48 x 50 mm	EK 671-02
64 x 50 mm	EK 671-03
64 x 64 mm	EK 671-04
80 x 57 mm	EK 671-05



SCOVILLE	
50 x 25 mm	EK 672-01
50 x 50 mm	EK 672-02
57 x 25 mm	EK 672-03
57 x 38 mm	EK 672-04
64 x 25 mm	EK 672-05
64 x 50 mm	EK 672-06
67 x 30 mm	EK 672-07
75 x 25 mm	EK 672-08
75 x 50 mm	EK 672-09
88 x 25 mm	EK 672-10
100 x 50 mm	EK 672-11



MEYERDING	
44 x 25 mm	EK 673-01
50 x 25 mm	EK 673-02
57 x 25 mm	EK 673-03
70 x 25 mm	EK 673-04
75 x 25 mm	EK 673-05
83 x 25 mm	EK 673-06
88 x 50 mm	EK 673-07



TAYLOR	
75 x 32 mm	EK 674-01
100 x 42 mm	EK 674-02

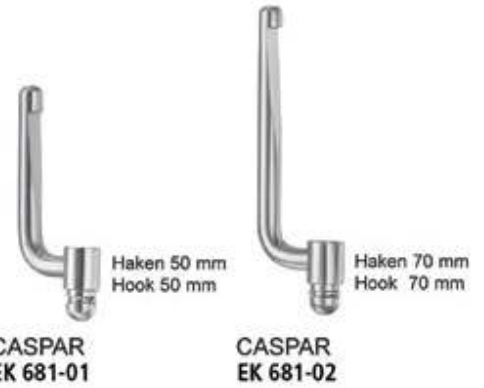

CASPAR

35 x 22 mm	EK 682-01
40 x 22 mm	EK 682-02
45 x 22 mm	EK 682-03
50 x 22 mm	EK 682-04
55 x 22 mm	EK 682-05
60 x 22 mm	EK 682-06
65 x 22 mm	EK 682-07

CASPAR

35 x 37 mm	EK 683-01
40 x 37 mm	EK 683-02
45 x 37 mm	EK 683-03
50 x 37 mm	EK 683-04
55 x 37 mm	EK 683-05
60 x 37 mm	EK 683-06
65 x 37 mm	EK 683-07
70 x 37 mm	EK 683-08

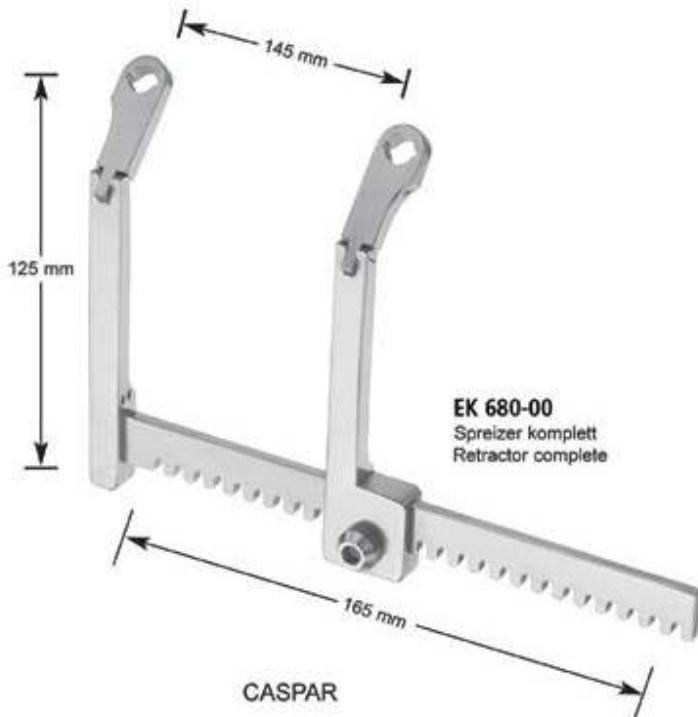

CASPAR

35 x 52 mm	EK 684-01
40 x 52 mm	EK 684-02
45 x 52 mm	EK 684-03
50 x 52 mm	EK 684-04
55 x 52 mm	EK 684-05
60 x 52 mm	EK 684-06
65 x 52 mm	EK 684-07
70 x 52 mm	EK 684-08

EK 680-01
 Drehschlüssel allein
 Key only



Laminektomi Otomatik Ekartörleri
Self Retaining Laminectomy Retractors
Laminektomie-Wundspreizer



EK 701-01
40 mm



EK 702-01
40 mm



EK 701-02
45 mm



EK 702-02
45 mm



EK 701-03
50 mm



EK 702-03
50 mm



EK 701-04
55 mm



EK 702-04
55 mm



EK 701-05
60 mm



EK 702-05
60 mm



Vertebral Lumbar Ekartörleri
Retractors for Lumbar Vertebral Column
Wundspreizer für die Lumbale Wirbelsäule

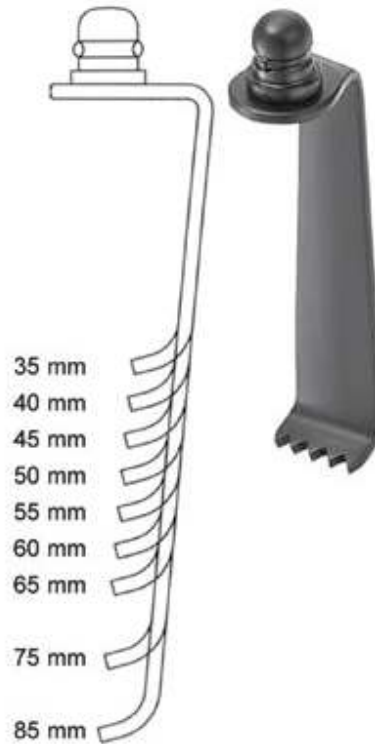

laterale Blätter
 lateral blades

CASPAR

35 mm	EK 710-01
40 mm	EK 710-02
45 mm	EK 710-03
50 mm	EK 710-04
55 mm	EK 710-05
60 mm	EK 710-06
65 mm	EK 710-07
75 mm	EK 710-08
85 mm	EK 710-09

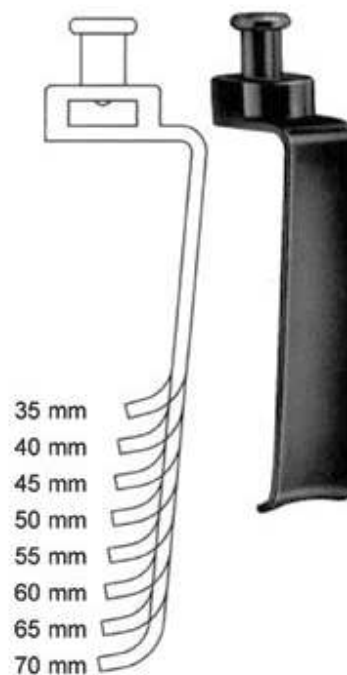

mediale Blätter
 medial blades

CASPAR

35 mm	EK 710-10
40 mm	EK 710-11
45 mm	EK 710-12
50 mm	EK 710-13
55 mm	EK 710-14
60 mm	EK 710-15
65 mm	EK 710-16
70 mm	EK 710-17

Vertebral Lumbar Ekartörleri
Retractors for Lumbar Vertebral Column
Wundspreizer für die Lumbale Wirbelsäule



CASPAR	
40 mm	EK 711-01
45 mm	EK 711-02
50 mm	EK 711-03
55 mm	EK 711-04
60 mm	EK 711-05
65 mm	EK 711-06
75 mm	EK 711-07
85 mm	EK 711-08



CASPAR	
45 mm	EK 712-01
50 mm	EK 712-02
55 mm	EK 712-03
60 mm	EK 712-04
65 mm	EK 712-05



CUSHING-LANDOLT	
70 x 15 mm	EK 713-01
90 x 15 mm	EK 713-02
110 x 15 mm	EK 713-03



PAPAVERO-CASPAR	
80 x 11 mm	EK 714-01
90 x 13 mm	EK 714-02
100 x 15 mm	EK 714-03



HARDY	
70 mm	EK 715-01
80 mm	EK 715-02
90 mm	EK 715-03

Servikal Ekartör
Retractors for Cervical Spine
Wundspreizer für die Cervicale Wirbelsäule



stumpfe Blätter
 blunt blades

CASPAR

45 x 23 mm	EK 716-01
50 x 23 mm	EK 716-02
55 x 23 mm	EK 716-03
60 x 23 mm	EK 716-04
65 x 23 mm	EK 716-05



mediale Blätter
 medial blades

CASPAR

40 x 23 mm	EK 717-01
45 x 23 mm	EK 717-02
50 x 23 mm	EK 717-03
55 x 23 mm	EK 717-04
60 x 23 mm	EK 717-05



laterale Blätter
 lateral blades

CASPAR

40 x 23 mm	EK 718-01
45 x 23 mm	EK 718-02
50 x 23 mm	EK 718-03
55 x 23 mm	EK 718-04
60 x 23 mm	EK 718-05



stumpfe Blätter, zur Spanentnahme am Beckenkamm
 blunt blades, for harvesting of the fusion graft from the iliac crest

CASPAR

50 x 25 mm	EK 719-01
60 x 25 mm	EK 719-02



Distraktor allein
Distractor only



Boyun Distraksiyon Sistemi
Cervical Vertebral Body Distraction System
Cervicales Halswirbelkörper Distractionssystem



CASPAR
EK 720-05
20 cm/8"

Schraubendreher für
Distractionsschrauben
Screw driver
for Distraction screws



CASPAR
EK 720-06
14,5 cm/5¾"

Bohrer, Ø 1,7 mm
zum Vorbohren für Distractionsschrauben,
Bohrtiefe: 8 mm, Schaft Ø 2,35 mm
Twist drill, Ø 1.7 mm
for pre-boring holes for distraction
screws, drilling depth: 8 mm
shank Ø 2.35 mm



CASPAR
7 cm/2¾"

12 mm	EK 720-07
14 mm	EK 720-08
16 mm	EK 720-09
18 mm	EK 720-10

Distractionsschrauben zur Verwendung
mit Distraktoren
Distraction screws to be used with
distractors



LOVE
EK 800-21
21 cm/8¼"



LOVE
EK 802-01
19 cm/7½"



LOVE
EK 802-02
19 cm/7½"



LOVE
EK 802-03
19 cm/7½"

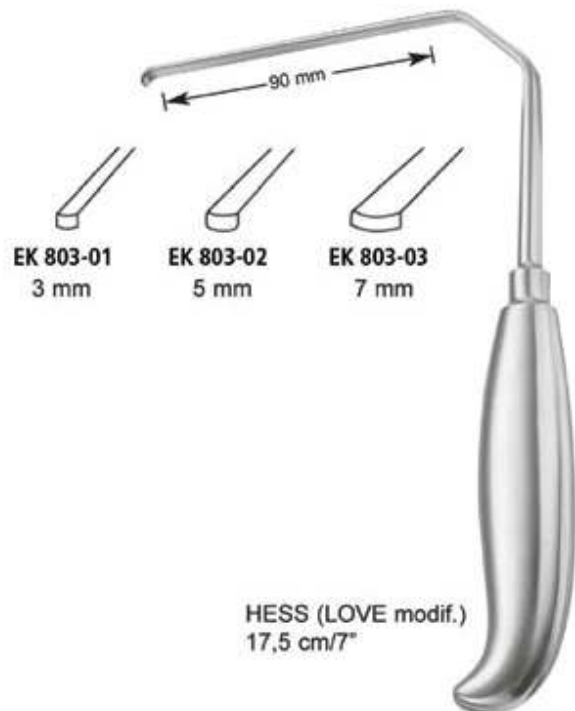

HESS (LOVE modif.)
17,5 cm/7"

Standart Pensetler
Dissecting Forceps
Anatomische Pinzetten



1/1

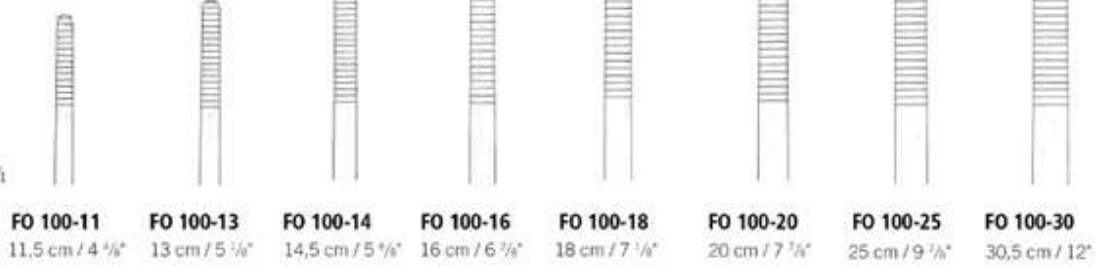

FO 100-11 11,5 cm / 4 1/8"	FO 100-13 13 cm / 5 1/8"	FO 100-14 14,5 cm / 5 7/8"	FO 100-16 16 cm / 6 3/8"	FO 100-18 18 cm / 7 1/8"	FO 100-20 20 cm / 7 7/8"	FO 100-25 25 cm / 9 7/8"	FO 100-30 30,5 cm / 12"
--------------------------------------	------------------------------------	--------------------------------------	------------------------------------	------------------------------------	------------------------------------	------------------------------------	-----------------------------------

1/2



1/1

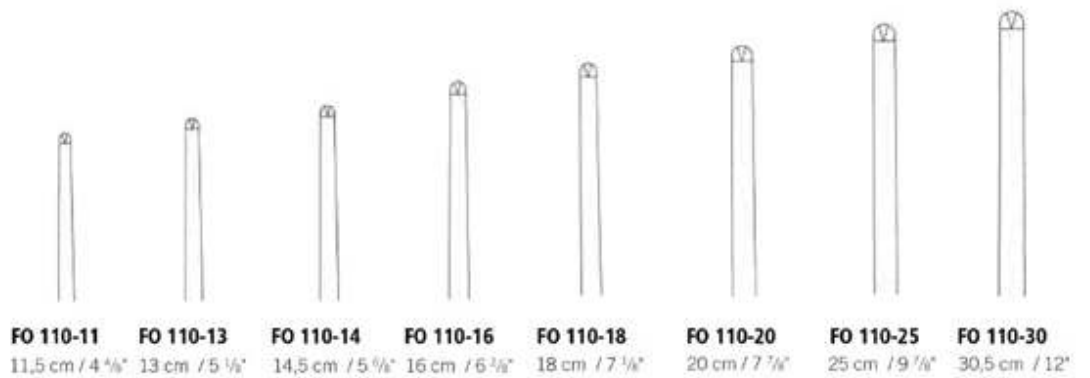

FO 110-11 11,5 cm / 4 1/8"	FO 110-13 13 cm / 5 1/8"	FO 110-14 14,5 cm / 5 7/8"	FO 110-16 16 cm / 6 3/8"	FO 110-18 18 cm / 7 1/8"	FO 110-20 20 cm / 7 7/8"	FO 110-25 25 cm / 9 7/8"	FO 110-30 30,5 cm / 12"
--------------------------------------	------------------------------------	--------------------------------------	------------------------------------	------------------------------------	------------------------------------	------------------------------------	-----------------------------------

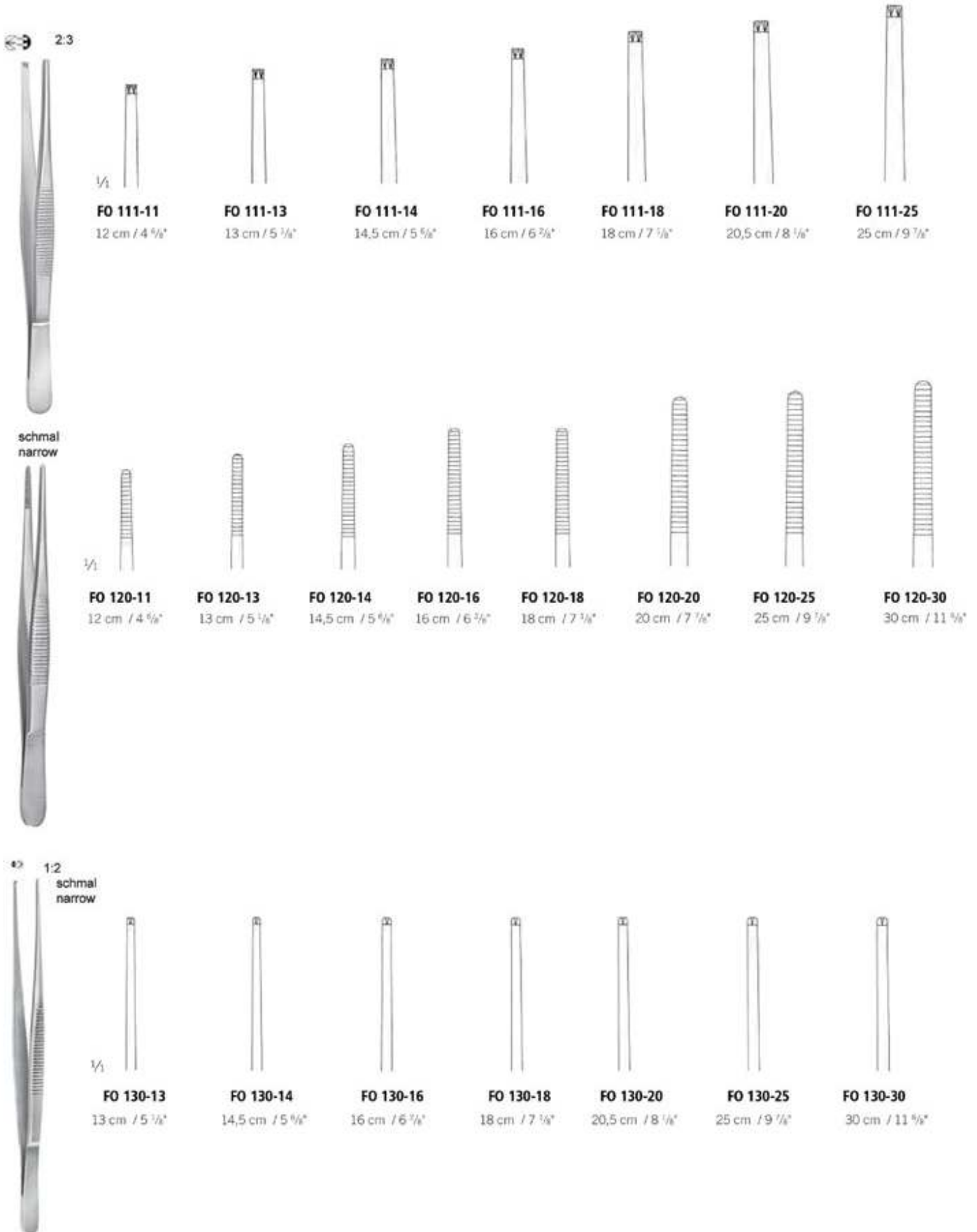

Hassas Pensetler
Delicate Dissecting Forceps
Feine Anatomische Pinzetten



ADSON

12 cm/4¾"	FO 200-12
15 cm/6"	FO 200-15
18 cm/7"	FO 200-18



ADSON micro

12 cm/4¾"	FO 201-12
15 cm/6"	FO 201-15



ADSON

12 cm/4¾"	FO 202-12
15 cm/6"	FO 202-15
18 cm/7"	FO 202-18



ADSON micro

12 cm/4¾"	FO 203-12
15 cm/6"	FO 203-15



Zähne schräggestellt
 Teeth in oblique position

ADSON-BIEMER
 FO 204-12
 12 cm/4¾"

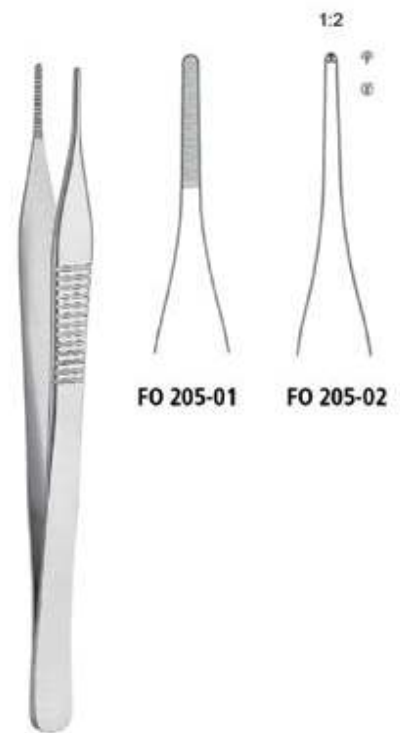

JEFFERSON
 18 cm/7"

FO 205-01

FO 205-02

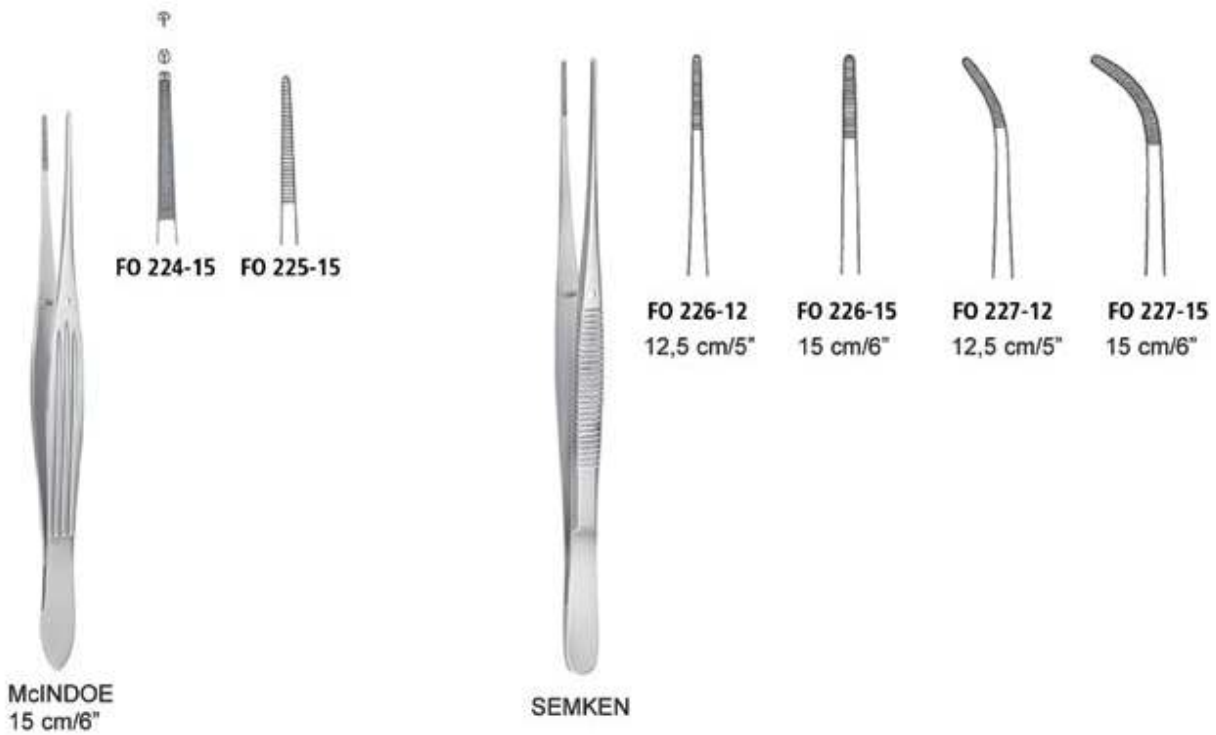
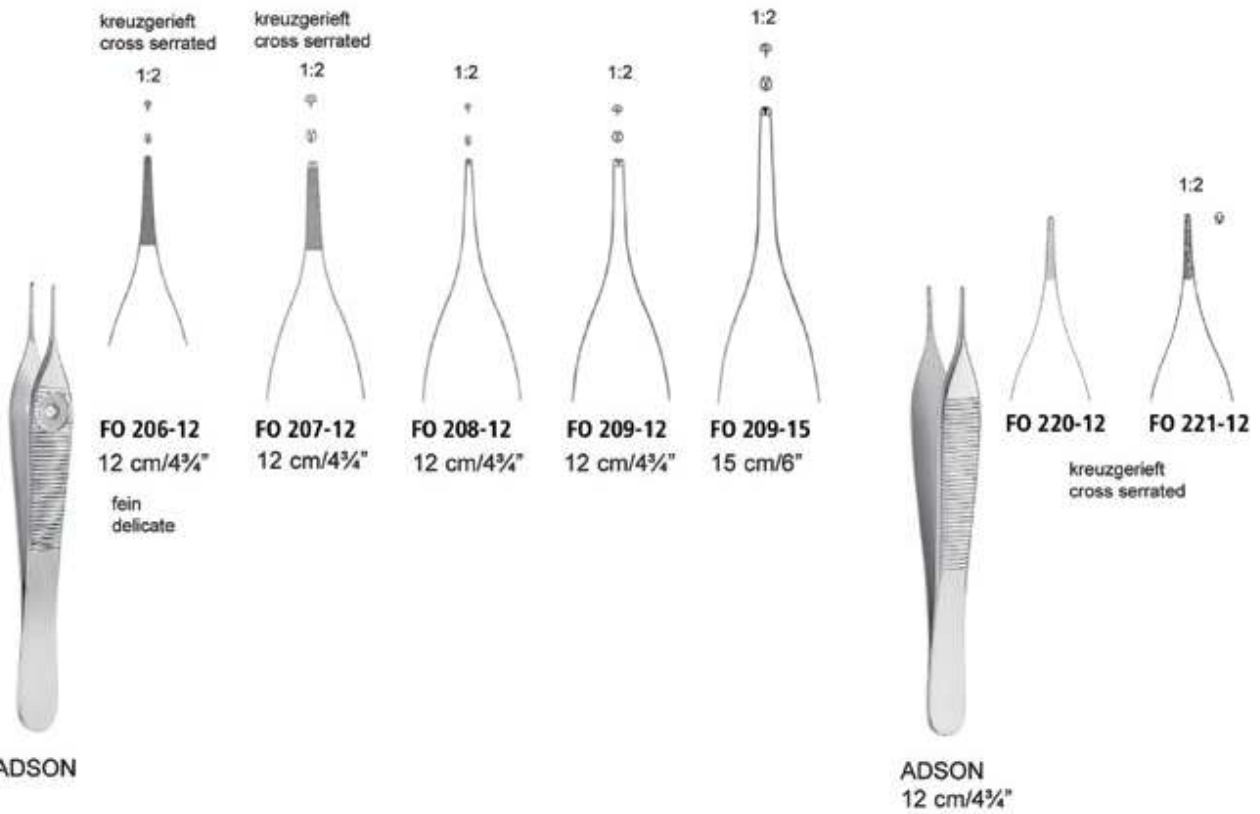

Hassas Pensetler
Delicate Dissecting Forceps
Feine Anatomische Pinzetten

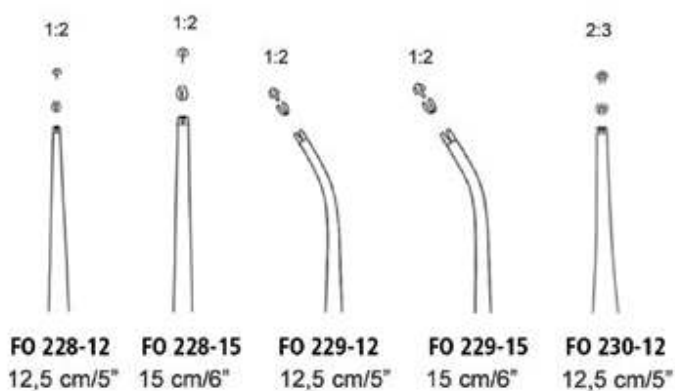

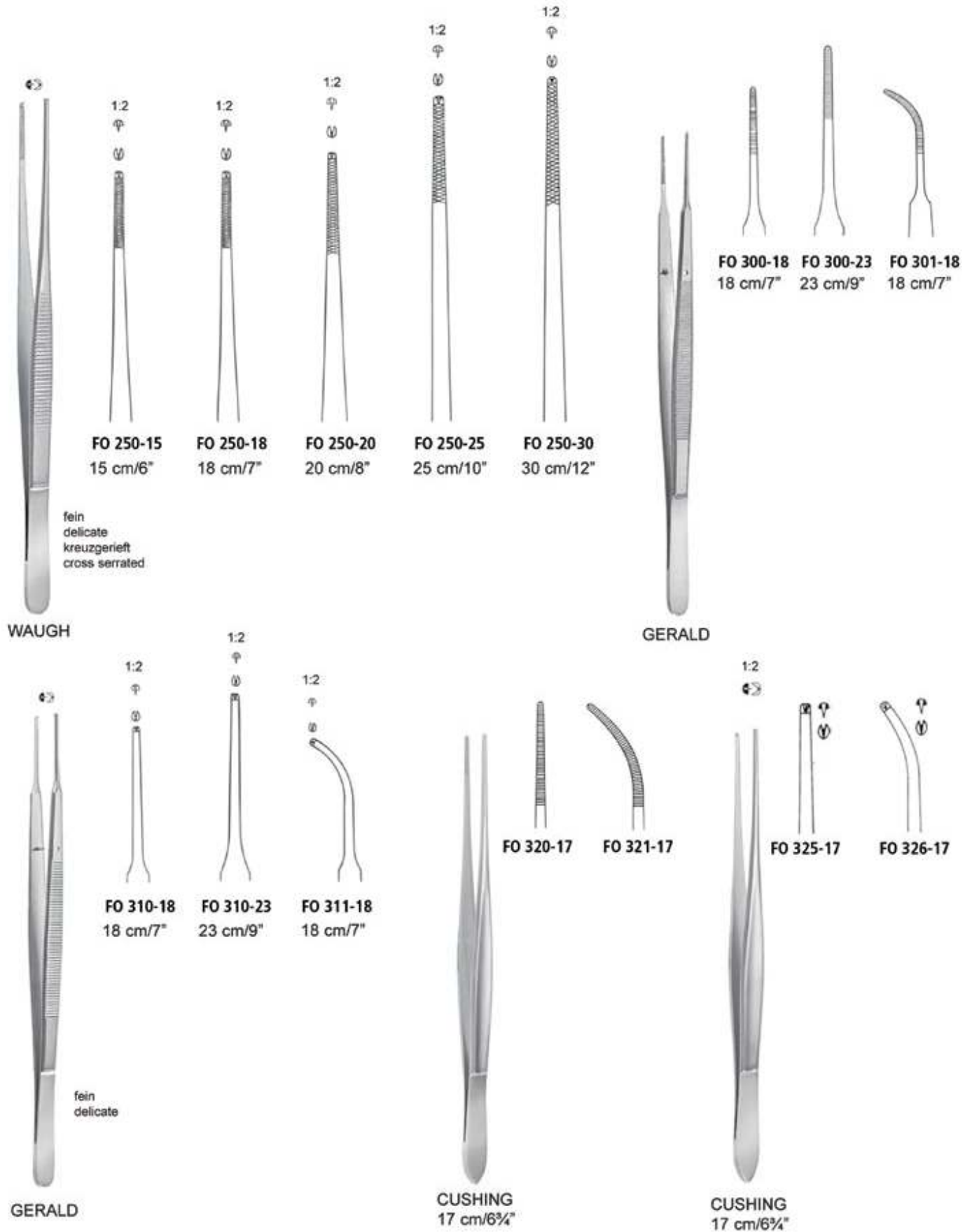

Hassas Pensetler
Delicate Dissecting Forceps
Feine Anatomische Pinzetten



POTTS-SMITH
 18 cm/7" FO 350-18
 21 cm/8¼" FO 350-21
 25 cm/10" FO 350-25



POTTS-SMITH
 18 cm/7" FO 360-18
 21 cm/8¼" FO 360-21
 25 cm/10" FO 360-25



BROPHY
 20 cm/8"

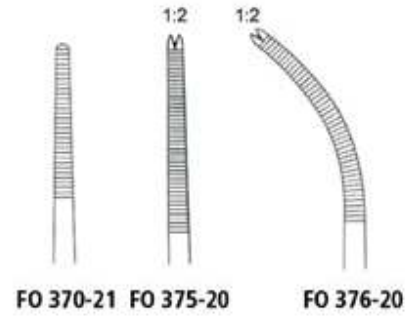

BROWN



FO 380-15
 15 cm/6"

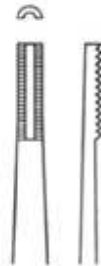

FO 380-20
 20 cm/8"

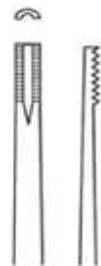

FO 380-25
 25 cm/10"



DUEHRSSSEN
 20 cm/8"



FO 385-20



FO 386-20



WANGENSTEEN
 23 cm/9"

FO 390-23

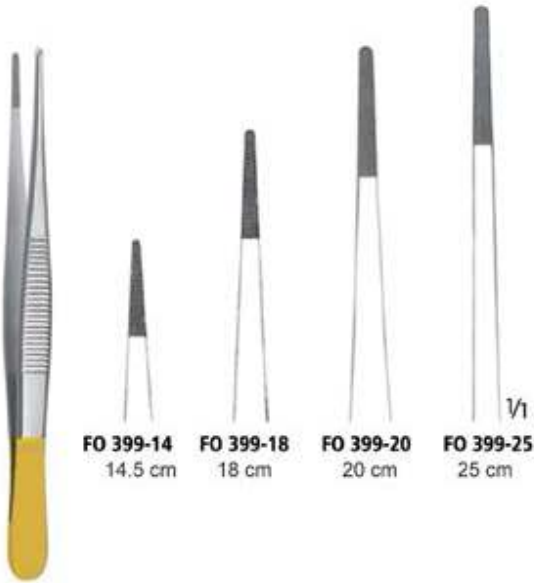

FO 399-14 14,5 cm
FO 399-18 18 cm
FO 399-20 20 cm
FO 399-25 25 cm



POTTS-SMITH

15,5 cm/6"	FO 400-15
18 cm/7"	FO 400-18
20 cm/8"	FO 400-20
23 cm/9"	FO 400-23
25 cm/10"	FO 400-25



GILLIES



ADSON

12 cm/4¾"	FO 405-12
15 cm/6"	FO 405-15



ADSON

12 cm/4¾"	FO 406-12
15 cm/6"	FO 406-15



McINDOE

FO 407-15
15 cm/6"



CUSHING
17 cm/6¾"

FO 407-17 **FO 408-18**

Diseksiyon Pensetleri
Non-traumatic Dissecting Forceps
Atraumatische Pinzetten



FO 409-18
 18,5 cm/7¼"

mit Schaberende
 with dissector end

CUSHING-TAYLOR



WANGENSTEEN
 15 cm/6" **FO 413-15**
 23 cm/9" **FO 413-23**



DE BAKEY

ATRAUMA



DE BAKEY

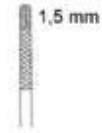

1,5 mm

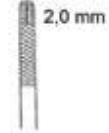

2,0 mm

15 cm/6"	FO 410-16	FO 411-16
19,5 cm/7¾"	FO 410-20	FO 411-20
24 cm/9½"	FO 410-24	FO 411-24



2,7 mm

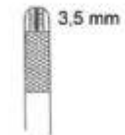

3,5 mm

15 cm/6"	FO 412-16	FO 413-16
19,5 cm/7¾"	FO 412-20	FO 413-20
24 cm/9½"	FO 412-24	FO 413-24

Hassas Pensetler
Delicate Dissecting Forceps
Feine Anatomische Pinzetten



FO 510-15
15,5 cm/6"
1:2
↻

GILLIES



LAZAR
15,5 cm/6"



FO 526-01
0,5 mm



FO 526-02
0,8 mm



FO 526-03
0,5 mm

18,5 cm/7¼"

Mikro Pensetler Kuyumcu Model
Micro Forceps , Jeweler Types
Mikro Pinzetten Uhrmacher Modelle



FO 530-00
12 cm/4¾"



FO 530-01
12 cm/4¾"

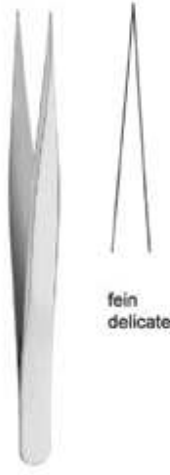

FO 530-02
11 cm/4¼"



FO 530-03
11 cm/4¼"



FO 530-04
11 cm/4¼"



FO 530-05
11 cm/4¼"



FO 530-07
11 cm/4¼"



FO 530-11
12 cm/4¾"

fein
delicate

0,3 mm
45°

Tümör Pensetleri
Forceps for grasping tissue tumors etc.
Pinzetten zum fassen von Gewebe Tumoren usw.

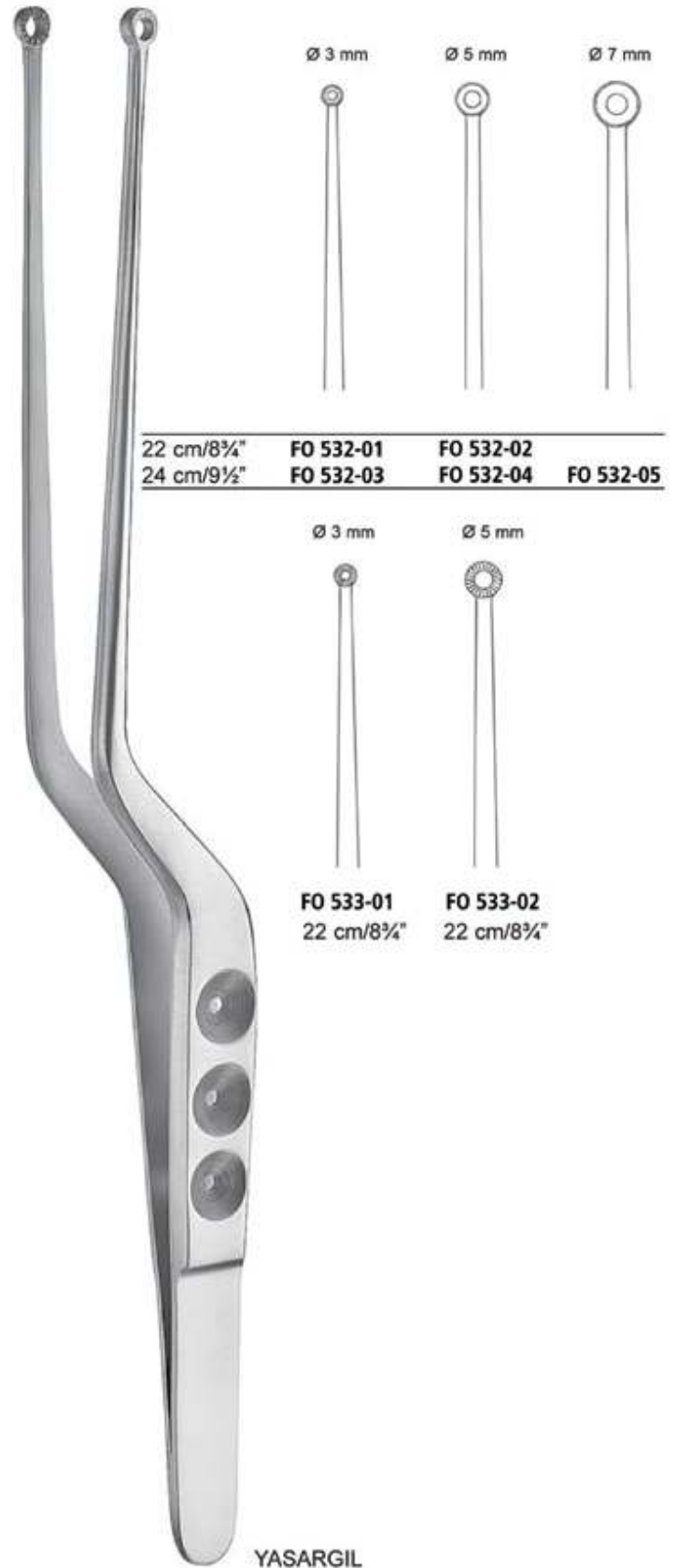
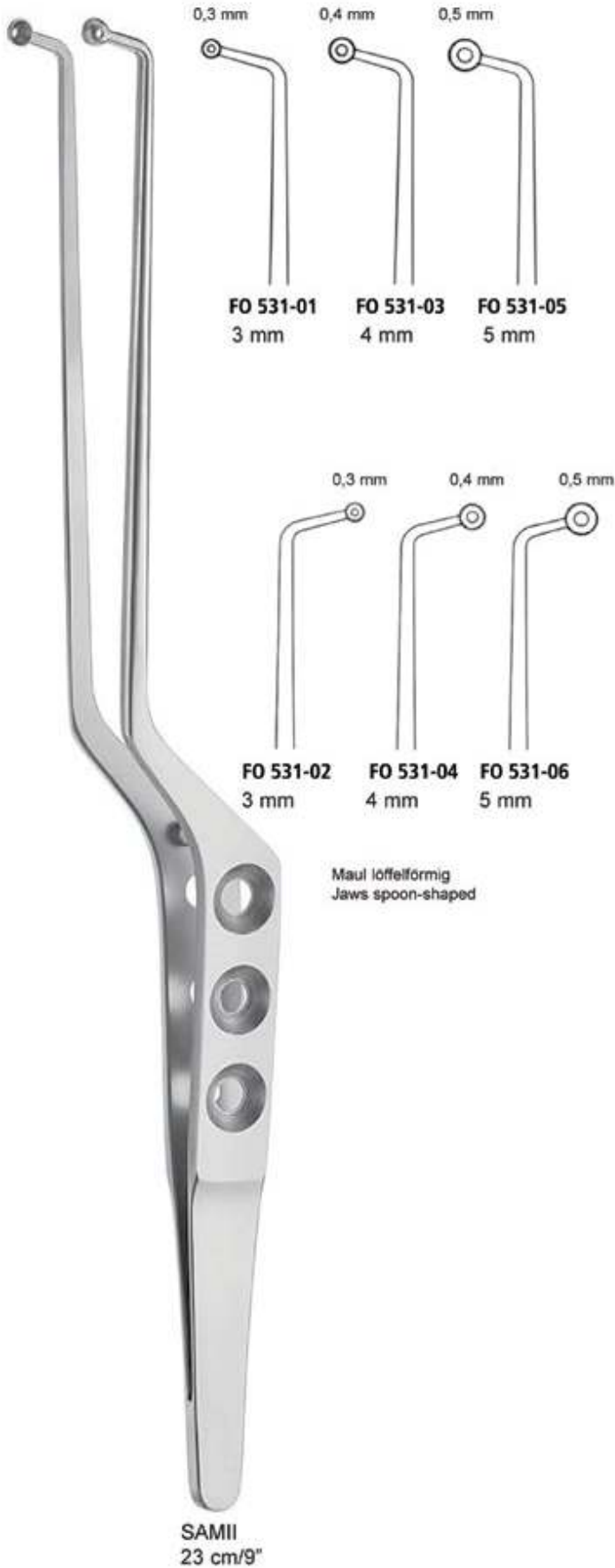

Tümör Pensetleri
Forceps for grasping tissue tumors etc.
Pinzetten zum fassen von Gewebe Tumoren usw.



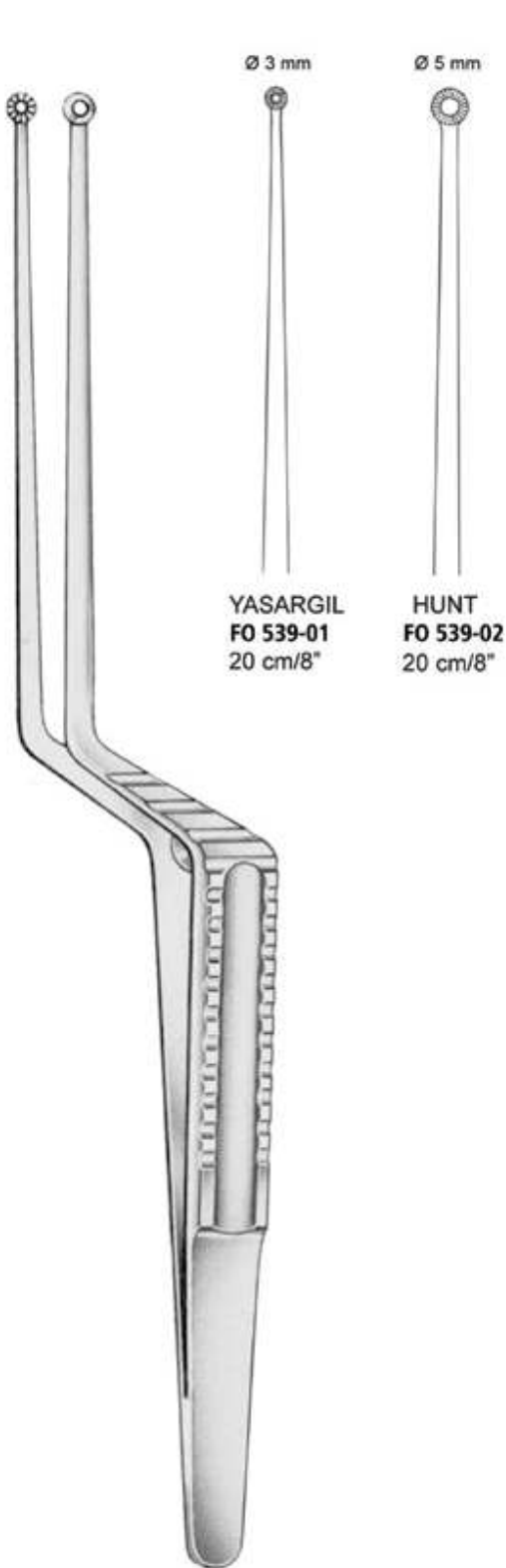

22 cm/8 3/4"

Hassas Pensetler
 Delicate Dissecting Forceps
 Feine Anatomische Pinzetten

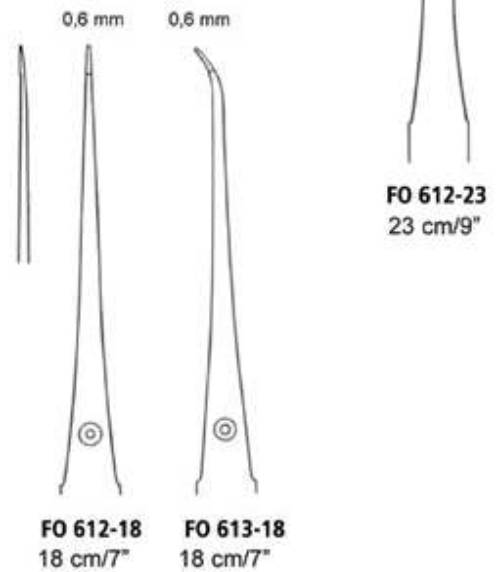
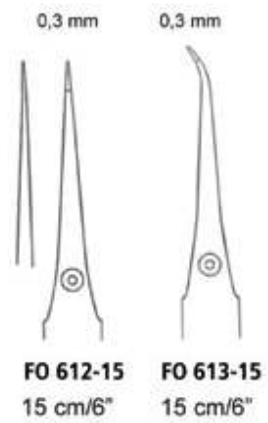
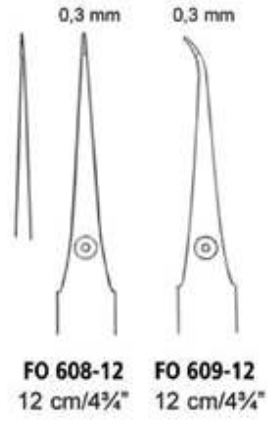



LUCAE
FO 703-14
 14 cm/5½"



JANSEN
FO 705-16
 16 cm/6¼"



ADSON
FO 705-18
 17,5 cm/7"



1:2
 FO 705-14
 14 cm/5½"

LUCAE



FO 706-14
 14 cm/5½"

COTTLE



1:2
 FO 707-16
 16 cm/6¼"



FO 710-20
 20 cm/8"

GRUENWALD



1:2
 FO 711-20
 20 cm/8"

Atravmatik Pensetler
Atraumatic Tissue Forceps
Atraumatische Pinzetten

ATRAUMA



DE BAKEY



DE BAKEY

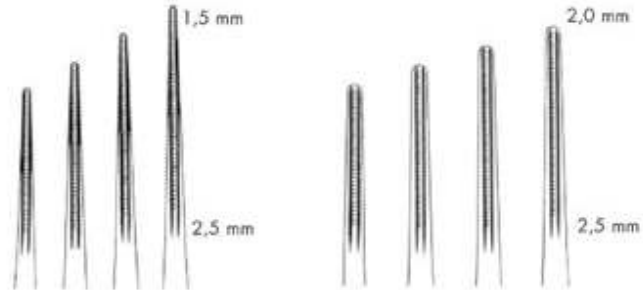

16 cm/6¼"	FO 950-16	FO 951-16
20 cm/8"	FO 950-20	FO 951-20
24 cm/9½"	FO 950-24	FO 951-24
30 cm/12"		FO 951-30



16 cm/6¼"	FO 952-16	FO 953-16
20 cm/8"	FO 952-20	FO 953-20
24 cm/9½"	FO 952-24	FO 953-24
30 cm/12"	FO 952-30	FO 953-30

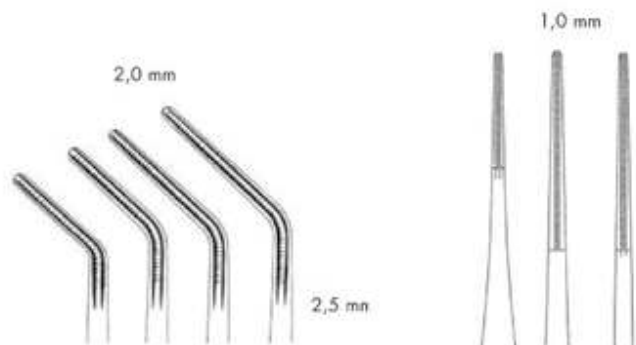

16 cm/6¼"	FO 954-16	FO 960-15
20 cm/8"	FO 954-20	FO 960-20
24 cm/9½"	FO 954-24	FO 960-24
30 cm/12"	FO 954-30	

ATRAUMA



DE BAKEY



	1,2 mm	1,5 mm
	FO 970-15 15 cm/6"	FO 970-20 20 cm/8"
	1,5 mm	1,5 mm
	FO 970-24 24 cm/9½"	FO 970-30 30 cm/12"



DE BAKEY-ADSON
 12 cm/4¾" **FO 975-12**
 15 cm/6" **FO 975-15**

ULTRA-LIGHT

Atravmatik Pensetler
Atraumatic Tissue Forceps
Atraumatische Pinzetten

Titanium

ATRAUMA



DE BAKEY



DE BAKEY

1,0 mm



1,5 mm



15 cm/6"	FO 980-15	FO 981-15
20 cm/8"	FO 980-20	FO 981-20
24 cm/9½"	FO 980-24	FO 981-24

2,0 mm



2,5 mm



2,8 mm

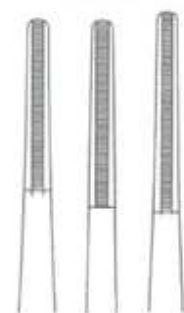

15 cm/6"	FO 982-15	FO 983-15	FO 984-15
20 cm/8"	FO 982-20	FO 983-20	FO 984-20
24 cm/9½"	FO 982-24	FO 983-24	FO 984-24
30 cm/12"	FO 982-30	FO 983-30	FO 984-30

3,5 mm



2,0 mm



15 cm/6"	FO 985-15	FO 986-15
20 cm/8"	FO 985-20	FO 986-20
24 cm/9½"	FO 985-24	FO 986-24
30 cm/12"	FO 985-30	FO 986-30

Organ ve Doku Klempleri
Organ and Tissue Grasping Forceps
Organ- und Gewebefazangen



ATRAUMA



DE BAKEY



Hemostatik Pensler
Haemostatic Forceps
Arterienklemmen

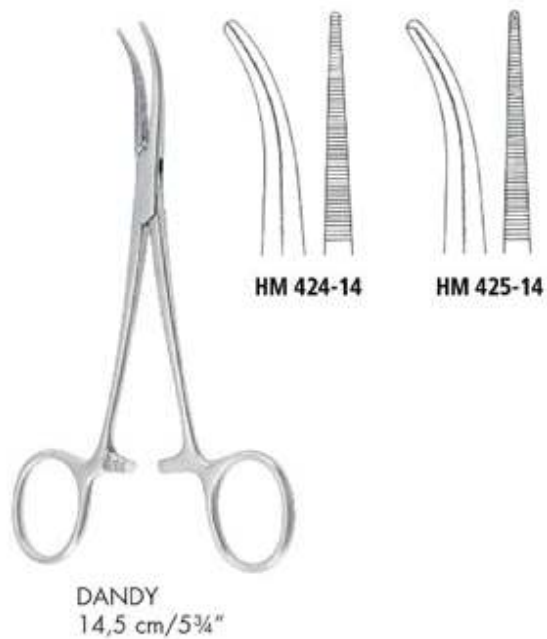

Hemostatik Pensler
Haemostatic Forceps
Arterienklemmen

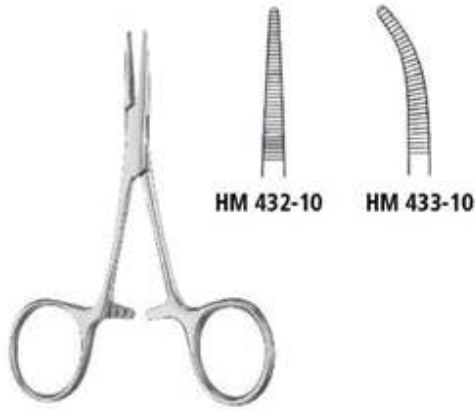

HARTMANN
 10 cm/4"

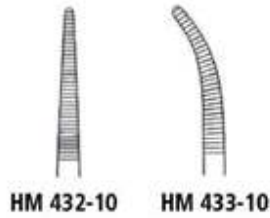

HALSTED-MOSQUITO micro

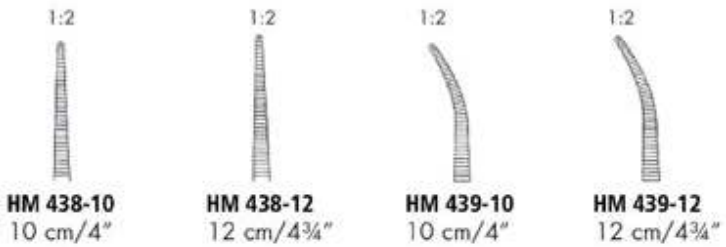
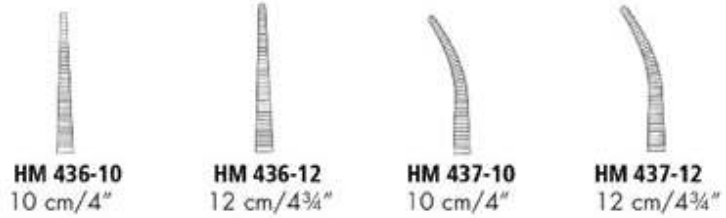

HALSTED-MOSQUITO

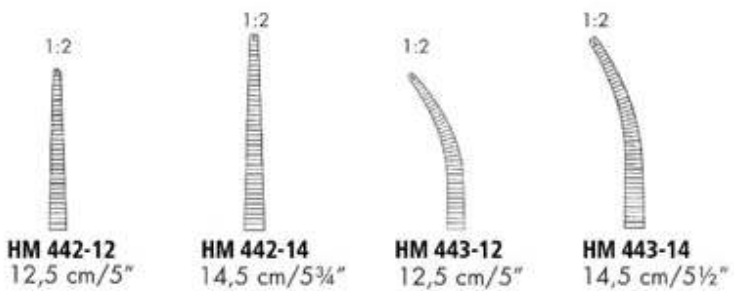
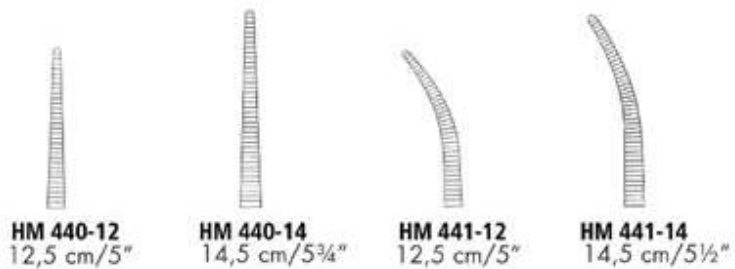

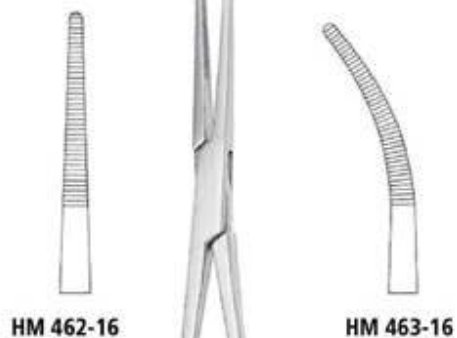
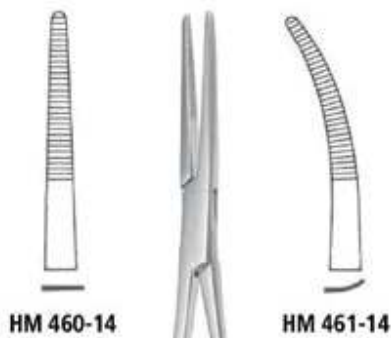
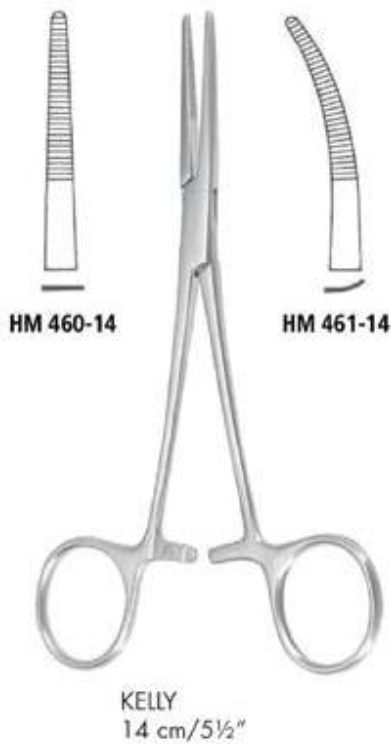
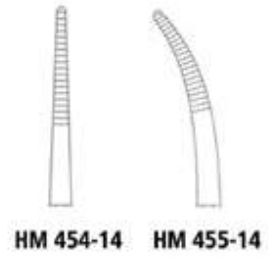
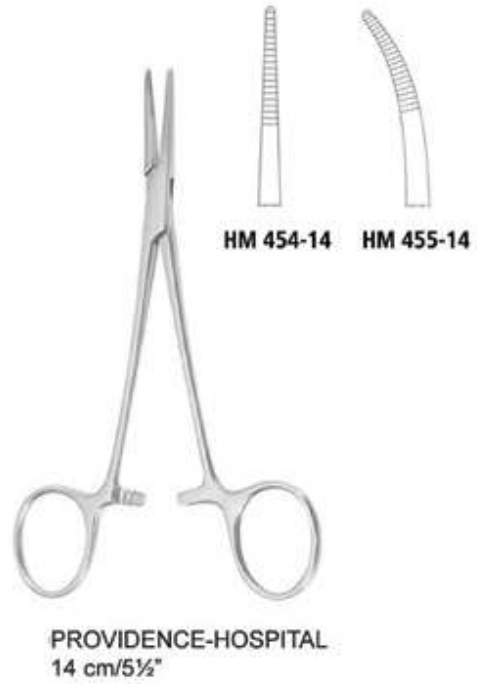
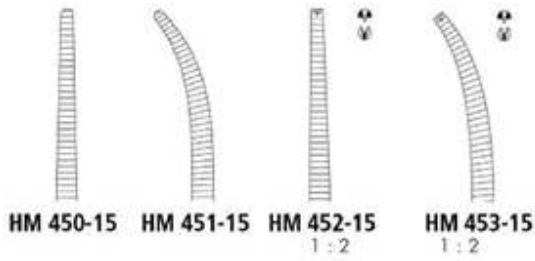

Hemostatik Pensler
Haemostatic Forceps
Arterienklemmen



CRILE
14 cm/5½"

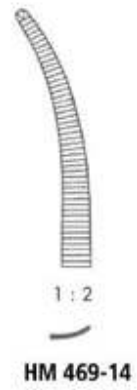

CRILE-RANKIN
16 cm/6¼"

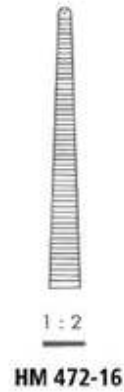
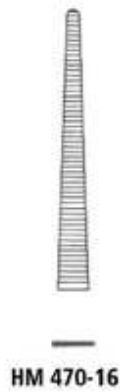



— DIEFFENBACH —

35 mm/1½"	HM 476-03	HM 477-03
50 mm/2"	HM 476-05	HM 477-05



— DIEFFENBACH —

58 mm/2¼"	HM 476-06	HM 477-06
-----------	------------------	------------------

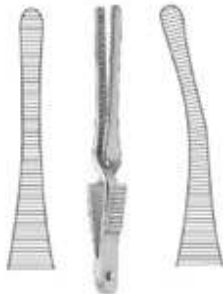

— JOHN-HOPKINS —

50 mm/2"	HM 480-05	HM 481-05
65 mm/2½"	HM 480-06	HM 481-06
75 mm/3"	HM 480-07	HM 481-07
90 mm/3½"	HM 480-09	HM 481-09



HM 480-00
 23 cm/8¼"

Hemostatik Pensler
Haemostatic Forceps
Arterienklemmen

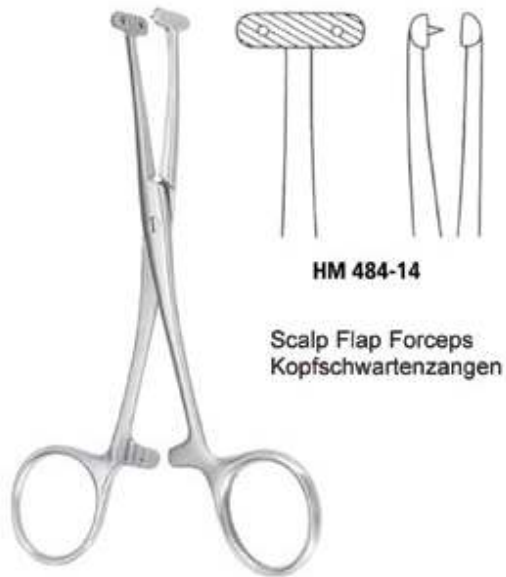

HM 484-14

Scalp Flap Forceps
Kopfschwartzangen

MARTEL
14 cm/5½"



HM 484-19

Scalp Flap Forceps
Kopfschwartzangen

WILLET-MARTEL
19 cm/7½"



HM 520-01

HM 520-02

Baby MIXTER
14 cm/5½"



MIXTER Baby
HM 522-18
18 cm/7"



GEMINI



HM 532-14
13 cm/5"



HM 532-16
16 cm/6¼"



HM 532-18
18 cm/7"

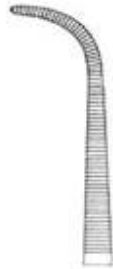

HM 532-20
20 cm/8"

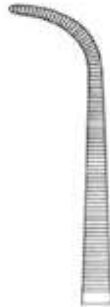

HM 532-23
23 cm/9"



HM 532-25
25 cm/10"



HM 532-28
28 cm/11"

Sinir ve Damar Hukları
Nerve and Vessel Hooks
Nerv-und Gefäßhäkchen



CRILE

HO 215-20
20 cm/8"



CUSHING

Fig. 1
HO 208-01
19 cm/7½"

HO 207-01
28 cm/11"



Fig. 1



Fig. 2

HO 208-02
19 cm/7½"

HO 207-02
28 cm/11"



Nerv- und Gefäßhäkchen
Nerve and vessel hooks

18,5 cm/7¼"



KRAYENBÜHL
HO 254-01
Fig. 1



KRAYENBÜHL
HO 254-02
Fig. 2



KRAYENBÜHL
HO 254-03
Fig. 3



KRAYENBÜHL
HO 254-04
Fig. 4



Explorations- und
Koagulationshäkchen
Exploration- and
Coagulation Hooks

insulated

CASPAR
24,5 cm/9¾"



HO 255-01



HO 255-03



HO 255-02



HO 255-04



ADSON
20 cm/8"



HO 256-01
spitz
sharp



HO 256-02
stumpf
blunt

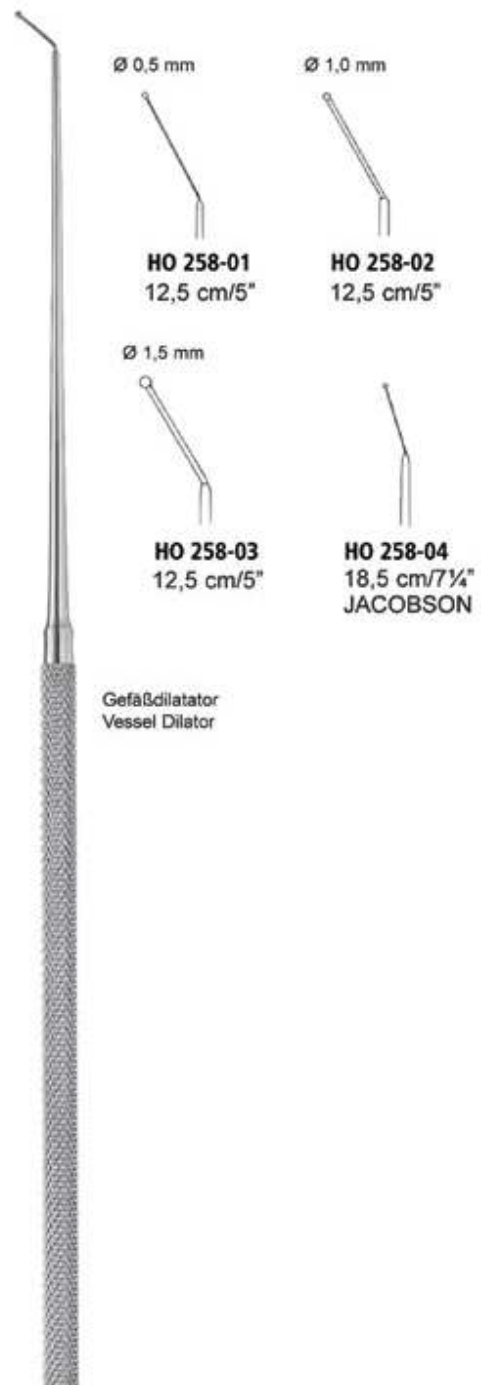
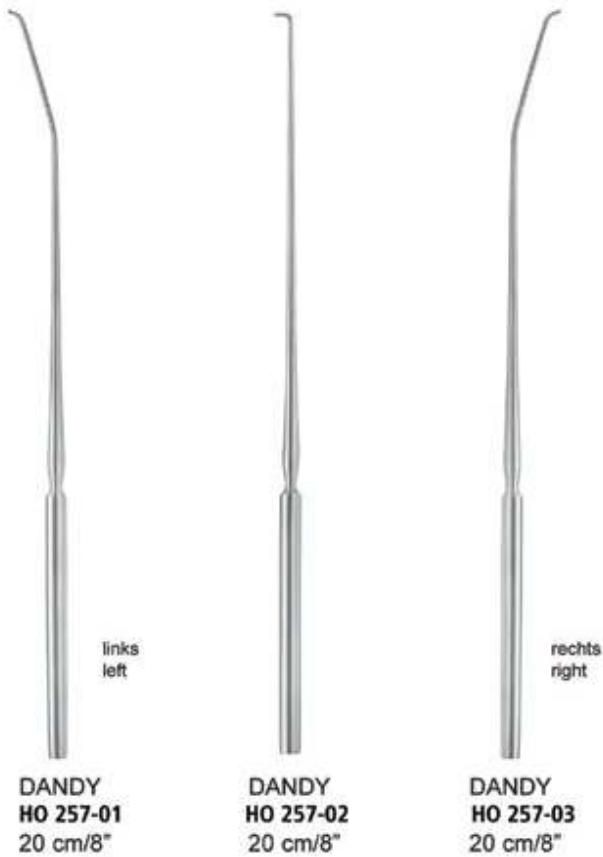

Sinir ve Damar Hukları
Nerve and Vessel Hooks
Nerv-und Gefäßhäkchen

Durahäkchen
Dura hooks



HO 259-01
 18,5 cm/7¼"
 90° scharf
 90° sharp



FISCH
HO 259-02
 18,5 cm/7¼"
 90° stumpf
 90° blunt



HO 259-03
 23 cm/9"
 scharf
 sharp



HO 259-04
 23 cm/9"
 stumpf
 blunt

Gefäß Messer
Vessel knife



KOOS
HO 265-01
 aufgebogen
 upwards curved



KOOS
HO 265-02
 abgebogen
 downward curved



KOOS
HO 265-03
 aufgebogen
 upwards curved



KOOS
HO 265-04
 abgebogen
 downward curved



KOOS
HO 265-05
 aufgebogen
 upwards curved



KOOS
HO 265-06
 abgebogen
 downward curved

Arachnoidea Messer
Arachnoid knife



YASARGIL
HO 265-07
 abgebogen
 downward curved



YASARGIL
HO 265-08
 aufgebogen
 upwards curved



18,5 cm/7¼"

Mikro Aletler
Micro Instruments with Round Handles
Mikro-Rundgriff Instrumente



Tumormesser
Tumor knives



HO 266-01 **HO 266-02**
 1,0 mm 1,5 mm



HO 266-03 **HO 266-04**
 2,0 mm 2,5 mm



HO 266-05 **HO 266-06**
 3,0 mm 3,5 mm



HO 266-07 **HO 266-08**
 4,0 mm 5,0 mm

Messer für Tumorgewebe
Knives for tumor tissue

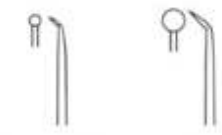

HO 267-01 **HO 267-02**
 1,5 mm 3,0 mm

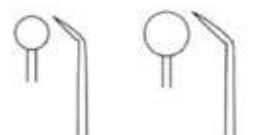

HO 267-03 **HO 267-04**
 4,5 mm 6,0 mm



HO 268-01 **HO 268-02**
 1,8 mm 2,5 mm

Tumorgabeln
Tumor forks

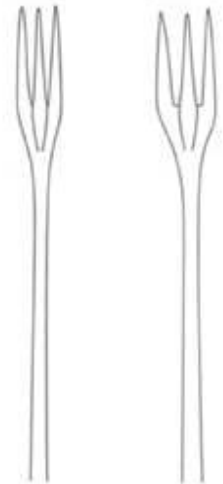

HO 270-01 **HO 270-02**



SAMII
 23 cm/9"

YASARGIL
 20 cm/8"

Mikro Aetler
Micro Instruments with Round Handles
Mikro-Rundgriff Instrumente

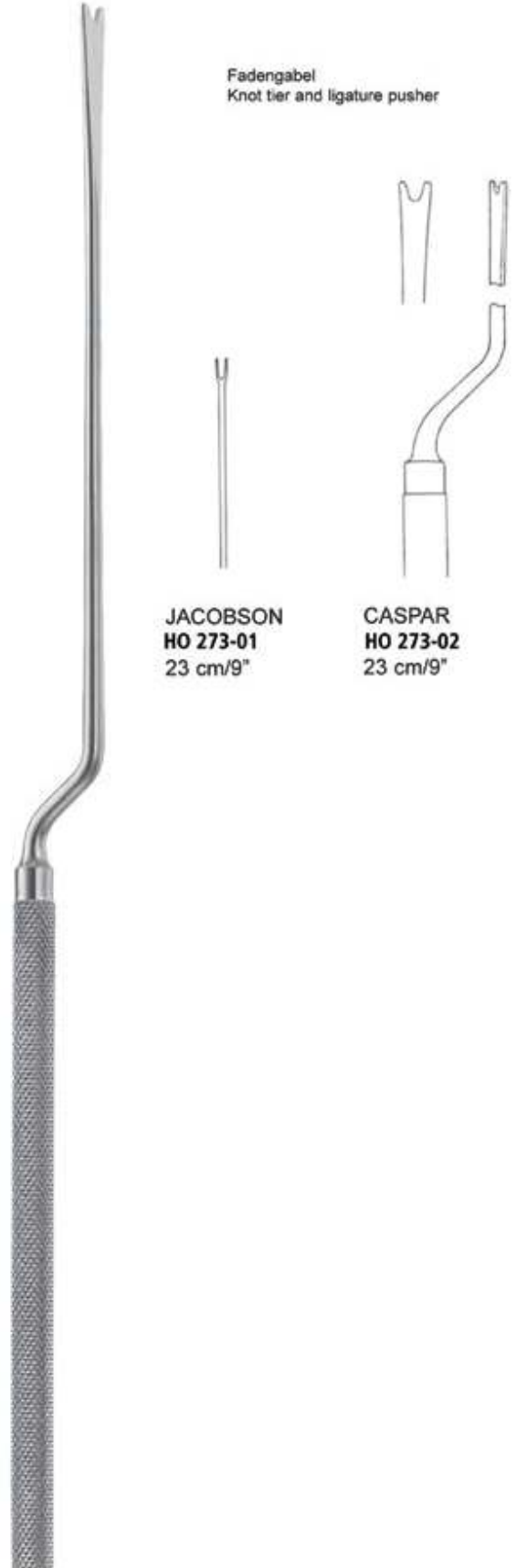

Küretten
Curettes



rechts gebogen
 right curved
 5 mm

HARDY
HO 275-01
 24 cm/9½"



links gebogen
 left curved
 5 mm

HARDY
HO 275-02
 24 cm/9½"



aufgewinkelt
 angled up

HARDY
 24 cm/9½"
 3 mm **HO 276-01**
 5 mm **HO 276-02**



abgewinkelt
 angled down

HARDY
 24 cm/9½"
 3 mm **HO 277-01**
 5 mm **HO 277-02**

Mikro Aetler
Micro Instruments with Round Handles
Mikro-Rundgriff Instrumente



HARDY
 24 cm/9½"

3 mm	HO 278-01
5 mm	HO 278-02



HARDY
 24 cm/9½"

3 mm	HO 279-01
5 mm	HO 279-02

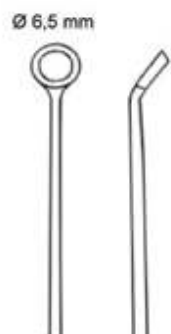

CONE
 23 cm/9"

3 mm	HO 281-01
4 mm	HO 281-02
6 mm	HO 281-03
7 mm	HO 281-04
8 mm	HO 281-05
9 mm	HO 281-06

CONE
 23 cm/9"

3 mm	HO 282-01
4 mm	HO 282-02
6 mm	HO 282-03
7 mm	HO 282-04
8 mm	HO 282-05
9 mm	HO 282-06

Hypophysenküretten, biegsam
 Pituitary Curettes, flexible



HARDY
 26 cm/10¼"

HO 282-01
 Ø 4 mm

HO 282-02
 Ø 6 mm

Küretten, biegsam
 Curettes, flexible

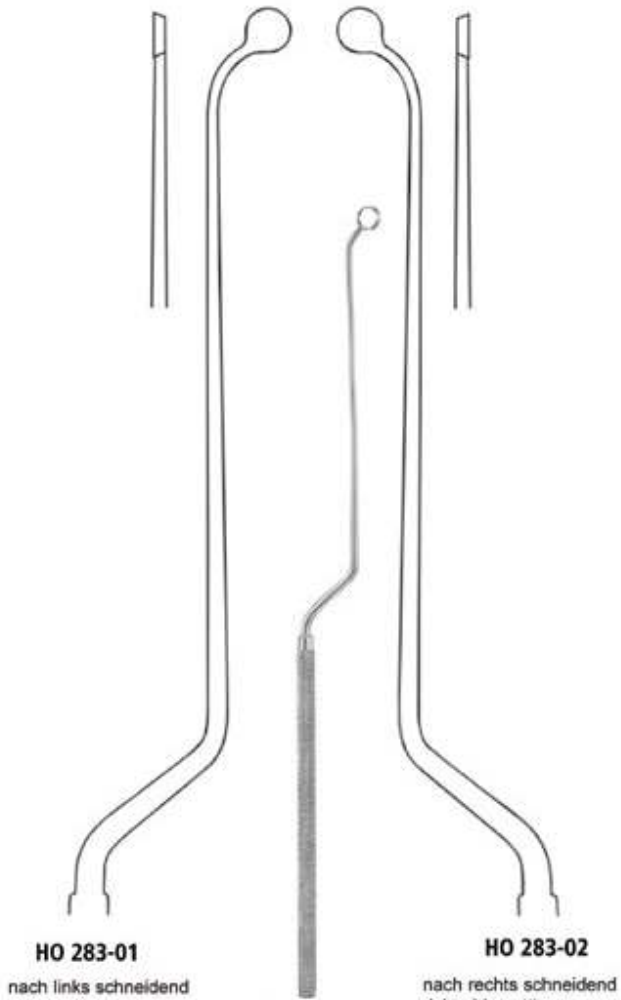

HO 283-01
 nach links schneidend
 left side cutting

NICOLA
 22 cm/8¾"
 Ø 6,5 mm

HO 283-02
 nach rechts schneidend
 right side cutting

Mikro Aetler
Micro Instruments with Round Handles
Mikro-Rundgriff Instrumente

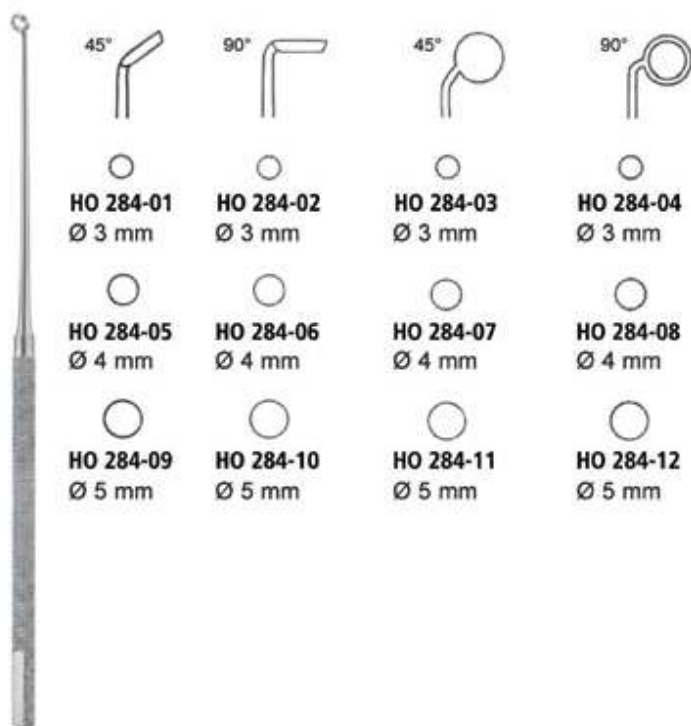

- | | | | |
|----------------------------|----------------------------|----------------------------|----------------------------|
| HO 284-01
Ø 3 mm | HO 284-02
Ø 3 mm | HO 284-03
Ø 3 mm | HO 284-04
Ø 3 mm |
| HO 284-05
Ø 4 mm | HO 284-06
Ø 4 mm | HO 284-07
Ø 4 mm | HO 284-08
Ø 4 mm |
| HO 284-09
Ø 5 mm | HO 284-10
Ø 5 mm | HO 284-11
Ø 5 mm | HO 284-12
Ø 5 mm |

RAY
 19 cm/7½"

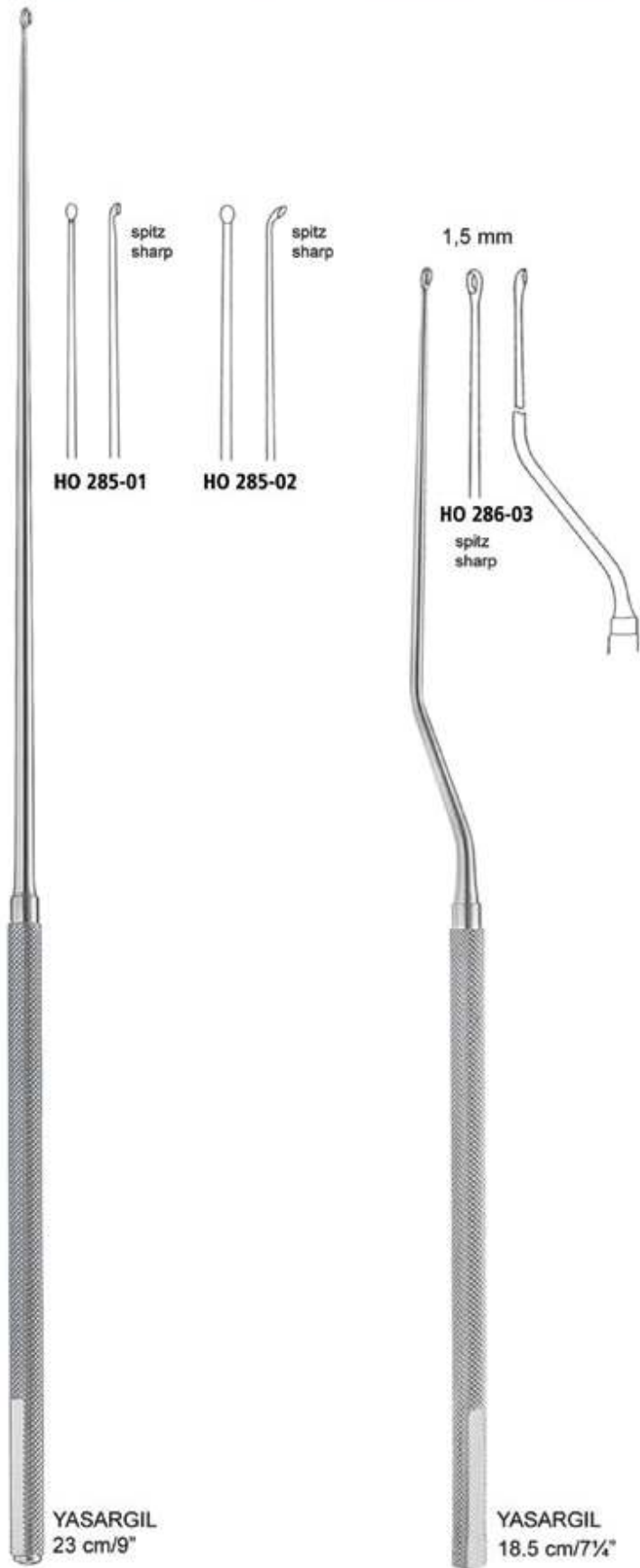

YASARGIL
 23 cm/9"

YASARGIL
 18.5 cm/7¼"

Enukleatoren, stumpf
Enucleators, blunt

Dissektoren, innen scharf
Dissectors, inner edge sharp

Implantationsgabel
Implant fork

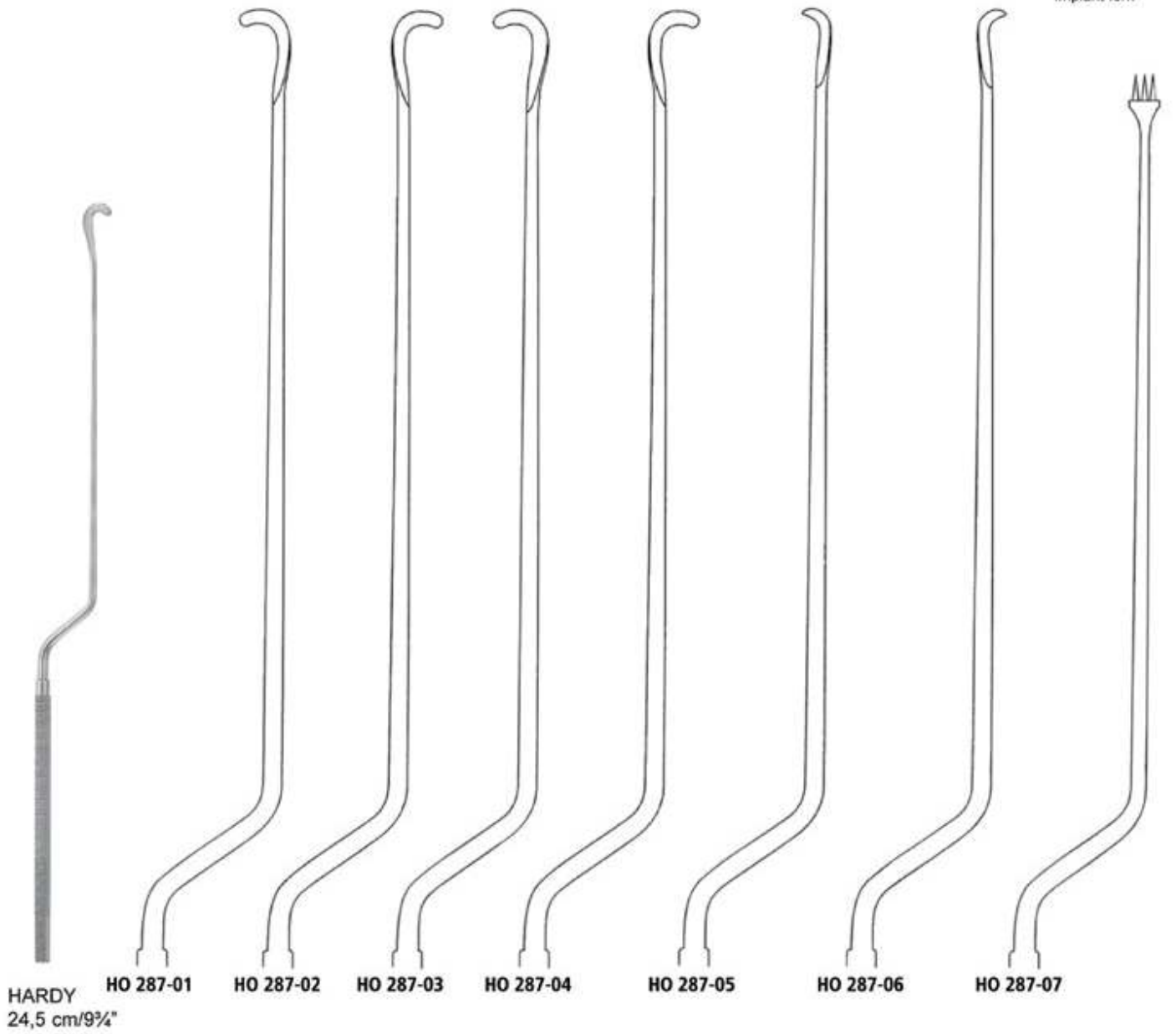

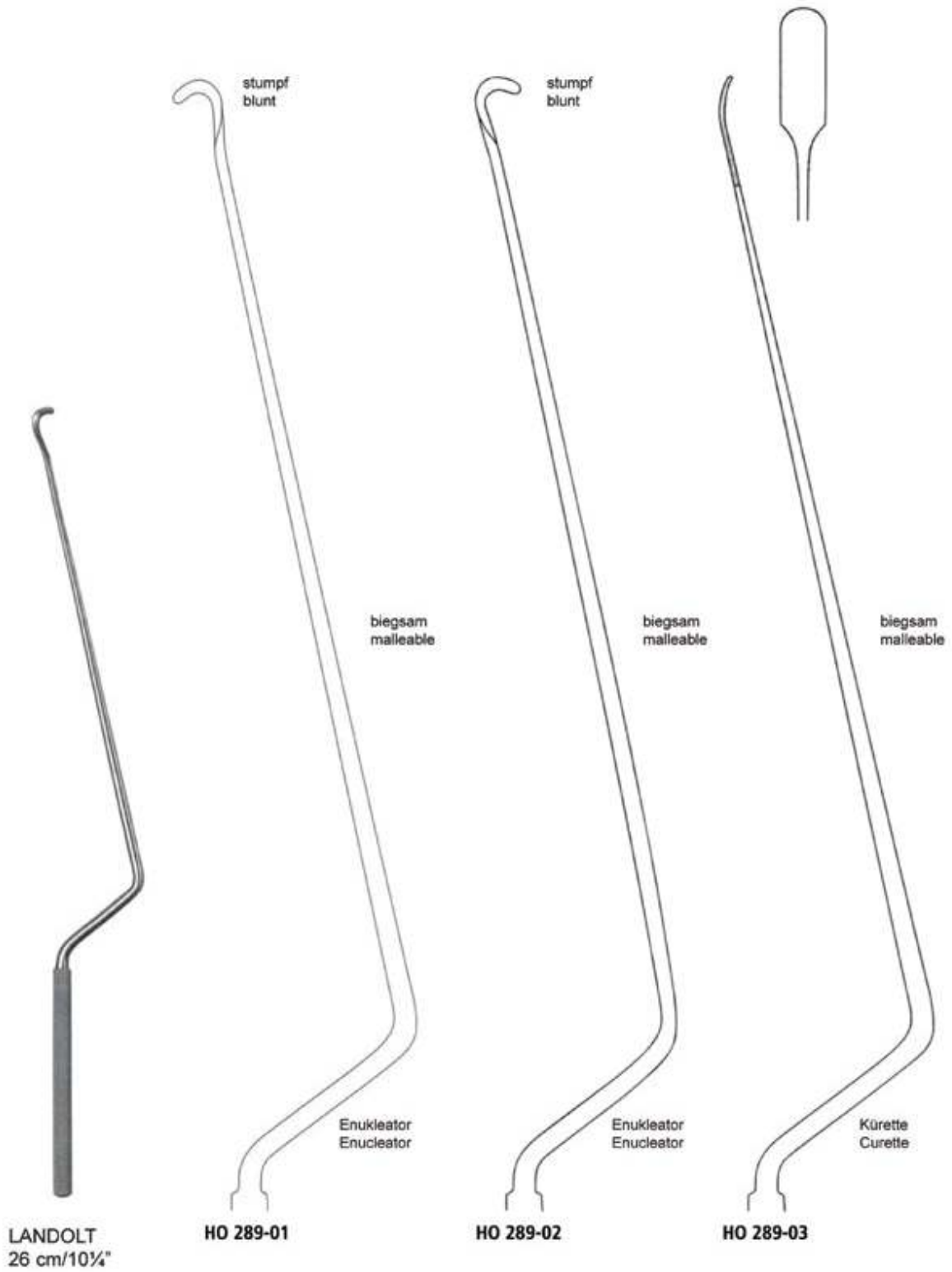

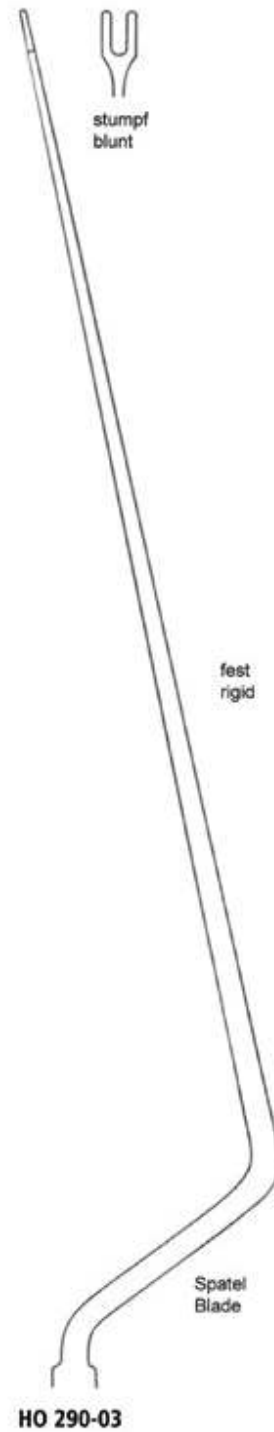
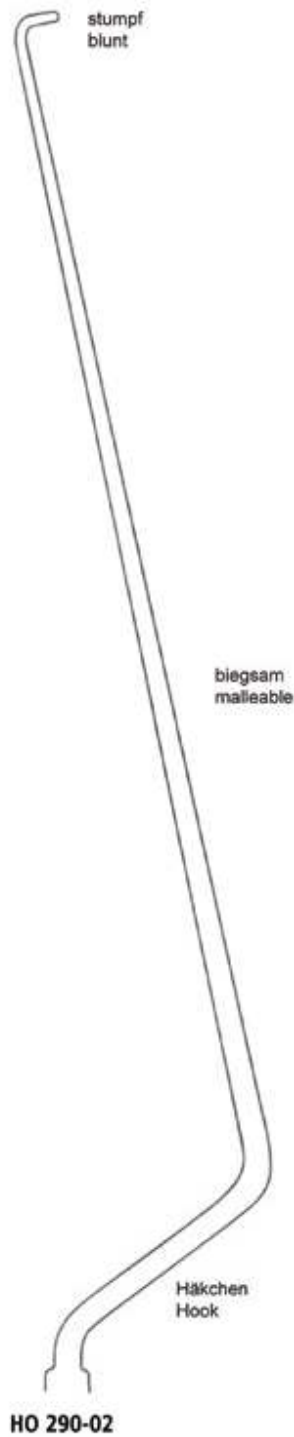
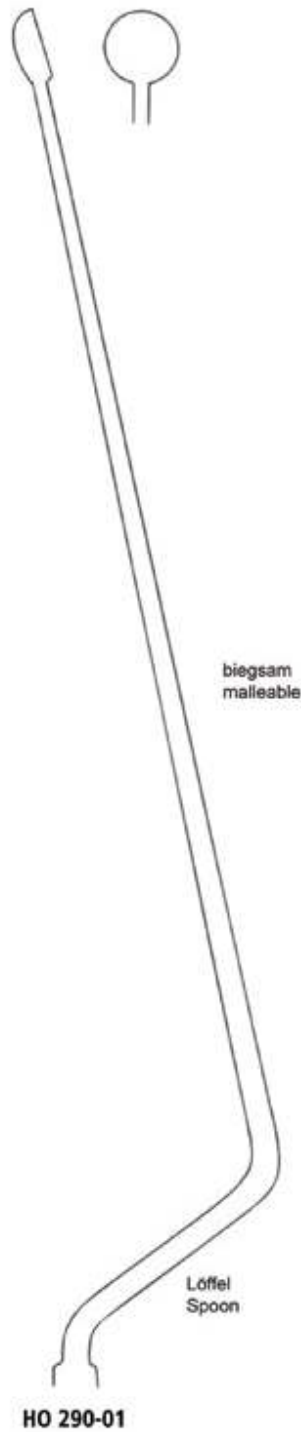

Mikro Aetler
Micro Instruments with Round Handles
Mikro-Rundgriff Instrumente



26 cm/10¼"

Ø 2,5 mm



FAHLBUSCH
HO 291-01

Kürette, biegsam
 Curette, malleable

Ø 2,2 mm



LANDOLT REULEN
HO 291-04

Raspatorium
 Raspatory

Ø 3,2 mm



LANDOLT REULEN
HO 291-05

Raspatorium
 Raspatory

Ø 2,5 mm



LANDOLT REULEN
HO 291-02

Kürette
 Curette



LANDOLT REULEN
HO 291-06

Stumpfes Häkchen
 Blunt hook

2,0 mm



LANDOLT REULEN
HO 291-07

Dissektor
 Dissector

Ø 2,0 mm



FAHLBUSCH
HO 291-03

Löffel, biegsam
 Spoon, malleable



HO 292-01
 Ø 1 mm
 Dissektor, rund
 Dissector, round



HO 292-02
 Ø 2 mm
 Dissektor, rund
 Dissector, round



HO 292-03
 Ø 3 mm
 Dissektor, rund
 Dissector, round



HO 292-04
 1,2 mm
 Elevator
 Elevator



HO 292-05
 2,8 mm
 Elevator
 Elevator



HO 292-06
 1 mm
 Dissektor, spatelförmig
 Dissector, spatula



HO 292-07
 1,5 mm
 Dissektor, spatelförmig
 Dissector, spatula



HO 292-08
 2 mm
 Dissektor, spatelförmig
 Dissector, spatula



HO 292-09
 2 mm
 Häkchen, halbscharf
 Hook, semi-sharp



HO 292-10
 2 mm
 Häkchen, stumpf
 Hook, blunt



HO 292-11
 3 mm
 Häkchen, halbscharf
 Hook, semi-sharp



HO 292-12
 Nadel, halbscharf
 Needle, semi-sharp



HO 292-13
 Knopfsonde
 Buttoned probes



HO 292-14
 1 x 2 mm
 Scharfeldöfel, oval
 Curette, oval



HO 292-15
 1 x 2 mm
 Scharfeldöfel, oval
 Curette, oval

RHOTON
 19 cm/7 1/2"

Mikro Aetler
Micro Instruments with Round Handles
Mikro-Rundgriff Instrumente

Dissektoren
Dissectors



HO 293-01
23 cm/9"
4,5 mm

HO 293-02
23 cm/9"
4,5 mm

HO 293-03
23 cm/9"
2 mm

HO 293-04
20 cm/8"
1 mm

HO 293-05
21 cm/8¼"
1 mm

HO 293-06
21 cm/8¼"
1 mm

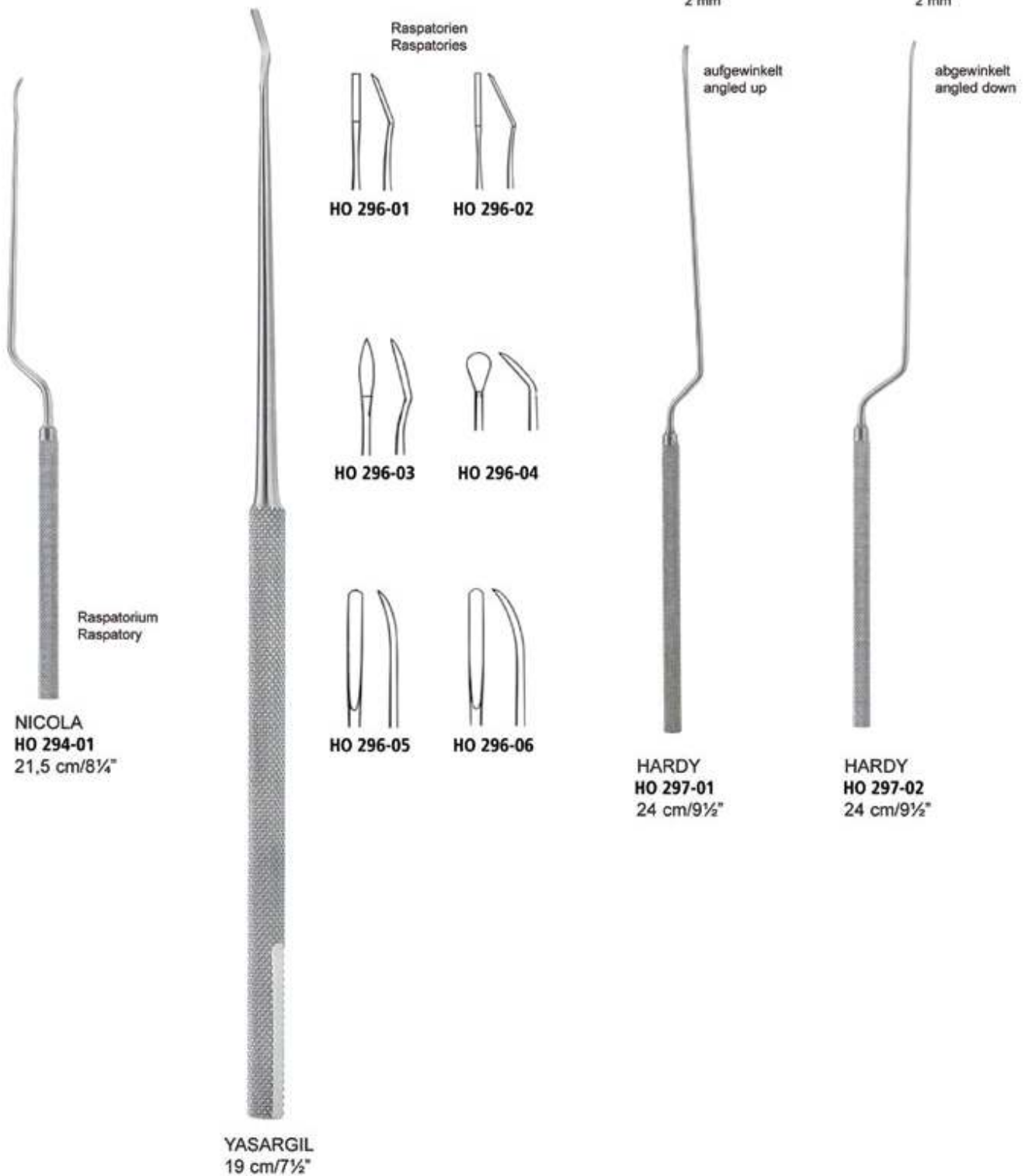

Bulldog Klempler
Bulldog Clamps
Bulldogklemmen

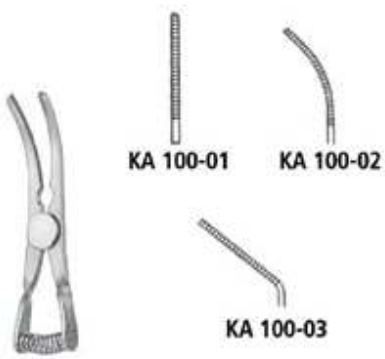

KA 100-01

KA 100-02

KA 100-03

GLOVER
 35 mm/1½"
 14 mm

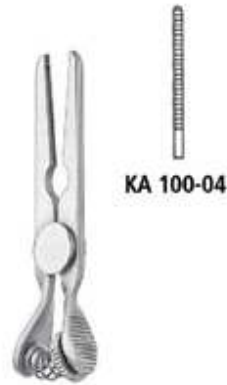

KA 100-04

KA 100-05

GLOVER
 45 mm/1¾"
 17 mm



DE BAKEY-GLOVER
KA 100-06
 50 mm/2"



DE BAKEY-GLOVER
KA 100-07
 50 mm/2"

ATRAUMA



DE BAKEY

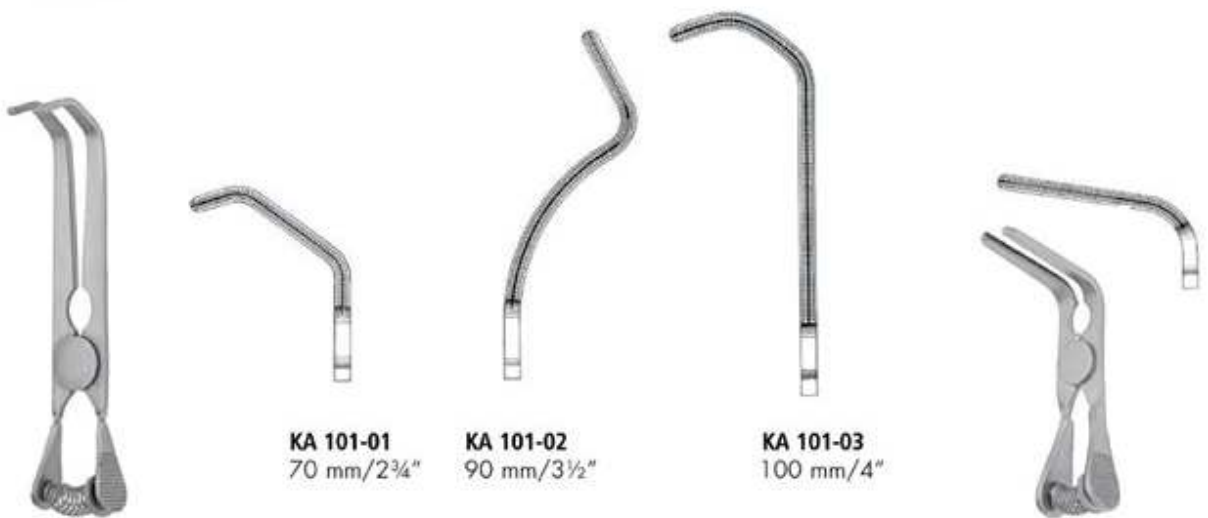

KA 101-01
 70 mm/2¾"

KA 101-02
 90 mm/3½"

KA 101-03
 100 mm/4"

DE BAKEY-SATINSKY

GLOVER
KA 103-01
 55 mm/2¼"
 27 mm

ATRAUMA



DE BAKEY



KA 105-01
 80 mm/3"
 20 mm



KA 105-02
 90 mm/3½"
 30 mm



KA 105-03
 105 mm/4¼"
 45 mm



KA 105-04
 125 mm/4¾"
 68 mm



DE BAKEY



KA 106-01
 75 mm/2¾"
 20 mm



KA 106-02
 85 mm/3¼"
 30 mm



KA 106-03
 95 mm/3½"
 45 mm



KA 106-04
 115 mm/4½"
 68 mm

Osteotom , Çizil , Gujlar
 Osteotomes , Chisels , Gouges
 Osteotome , Flach- , Hohlmeißel

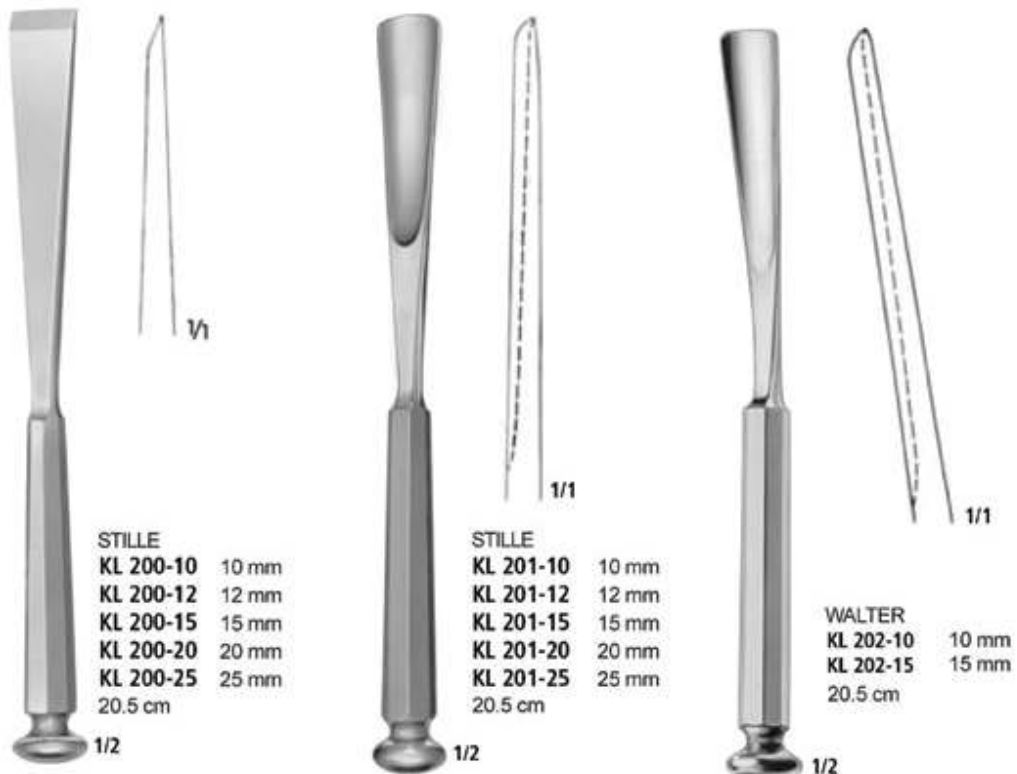
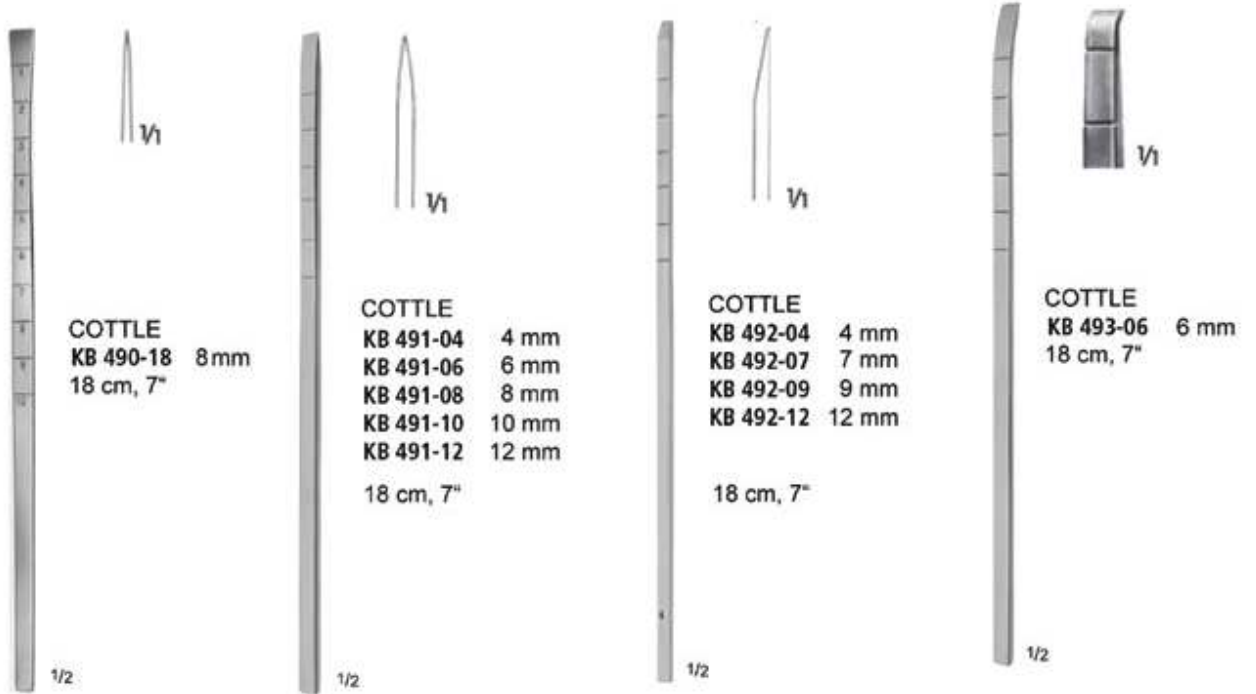



STILLE
KL 203-08 8 mm
KL 203-10 10 mm
KL 203-12 12 mm
KL 203-15 15 mm
KL 203-20 20 mm
KL 203-25 25 mm
20.5 cm

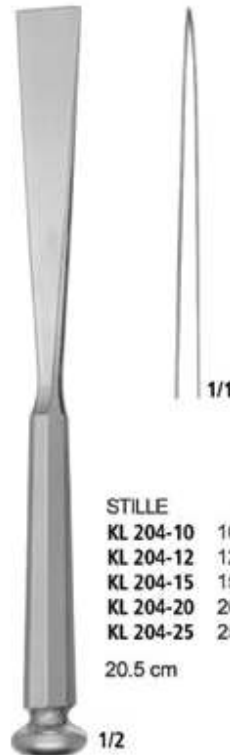

STILLE
KL 204-10 10 mm
KL 204-12 12 mm
KL 204-15 15 mm
KL 204-20 20 mm
KL 204-25 25 mm
20.5 cm



STILLE
KL 205-10 10 mm
KL 205-12 12 mm
KL 205-15 15 mm
KL 205-20 20 mm
KL 205-25 25 mm
20.5 cm



gerade
straight

6 mm/1/4"	KL 225-01
10 mm/1/8"	KL 225-02
13 mm/1/2"	KL 225-03
16 mm/5/8"	KL 225-04
19 mm/3/4"	KL 225-05
25 mm/1"	KL 225-06
32 mm/1 1/4"	KL 225-07

1/2
28 cm/11"

Osteotom , Çizil , Gujlar
Osteotomes , Chisels , Gouges
Osteotome , Flach- , Hohlmeißel



LUCAS
KL 230-04 4 mm
KL 230-06 6 mm
16 cm

1/2



LUCAS
KL 231-03 3 mm
KL 231-05 5 mm
16 cm

1/2

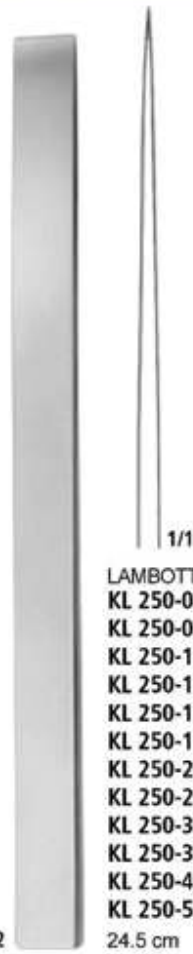

LAMBOTTE
KL 250-04 4 mm
KL 250-08 8 mm
KL 250-10 10 mm
KL 250-13 13 mm
KL 250-15 15 mm
KL 250-18 18 mm
KL 250-20 20 mm
KL 250-25 25 mm
KL 250-30 30 mm
KL 250-38 38 mm
KL 250-44 44 mm
KL 250-50 50 mm
24.5 cm

1/2

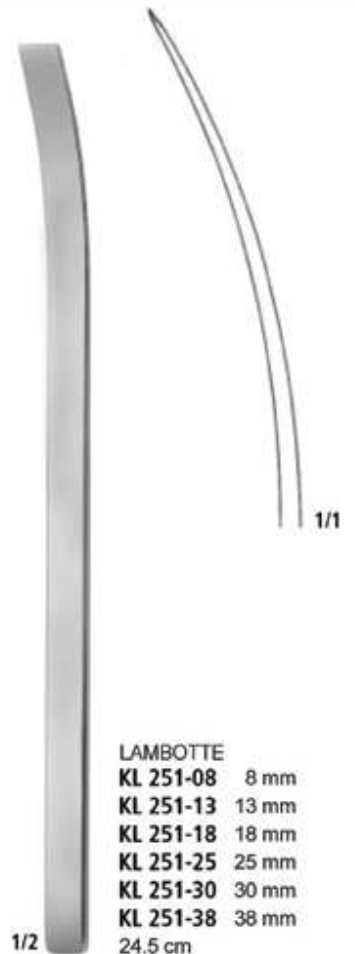

LAMBOTTE
KL 251-08 8 mm
KL 251-13 13 mm
KL 251-18 18 mm
KL 251-25 25 mm
KL 251-30 30 mm
KL 251-38 38 mm
24.5 cm

1/2



OBWEGESER
KL 252-11 11 mm
23.5 cm

1/2

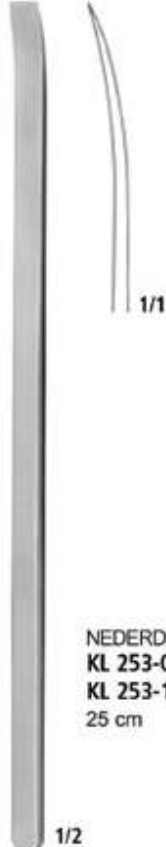

NEDERDELLMANN
KL 253-08 8 mm
KL 253-10 10 mm
25 cm

1/2



Osteotom , Çizil , Gujlar
 Osteotomes , Chisels , Gouges
 Osteotome , Flach- , Hohlmeißel



KL 419-01
 6 mm

KL 419-02
 8 mm

KL 419-03
 11 mm

KL 419-04
 16 mm

Wirbelsäulenmeißel, bajonettförmig
 Lamina gouge, cranked

23,5 cm/9¼"



KL 421-01



KL 421-02



KL 421-03



KL 421-04

Spinal-Fusions-Hohlmeißel
 Spinal Fusion Gouges

COBB
 28 cm/11"
 6 mm

½



Spinal-Fusions-Hohlmeißel
 Spinal Fusion Gouges



KL 420-01



KL 420-02



KL 420-03



KL 420-04

½

COBB
 28 cm/11"
 4 mm



Ø 25 mm

KB 900-18 140 gr
Plastic disks
18.5 cm



Ø 30 mm

**COTTLE
KB 902-18** 240 gr
18.5 cm



Ø 20 mm

**MEAD
KL 600-20** 185 gr
Plastic disc
19 cm



Ø 22 mm

KL 600-22 165 gr
19 cm



Ø 27 mm

**HAJEK
KL 601-21** 140 gr
21.5 cm



Ø 30 mm

KL 602-24 215 gr
Plastic disc
24.5 cm



Can be sterilized at 143°C
Woden

KL 608-35 Ø 35 mm
KL 608-42 Ø 42 mm
KL 608-50 Ø 50 mm
25 mm

Leyla Ekartör
Self-Retaining Retractors, for Skull Mounting
Retraktoren zur Fixation am Schädel



LF 100-00

Brain retractor, self retaining, flexible,
Hirnsattelhalter, selbsthaltend, flexibel,

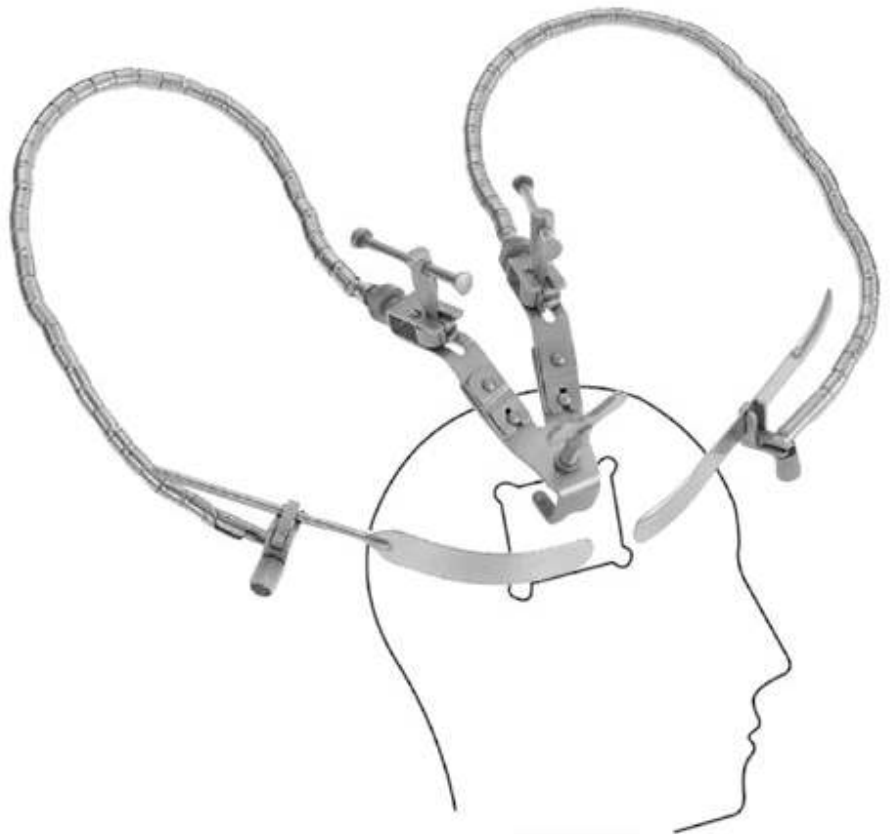

LF 101-00

Brain retractor, self retaining, flexible,
Hirnsattelhalter, selbsthaltend, flexibel,

Leyla Ekartör
Self-Retaining Retractors, for Skull Mounting
Retraktoren zur Fixation am Schädel

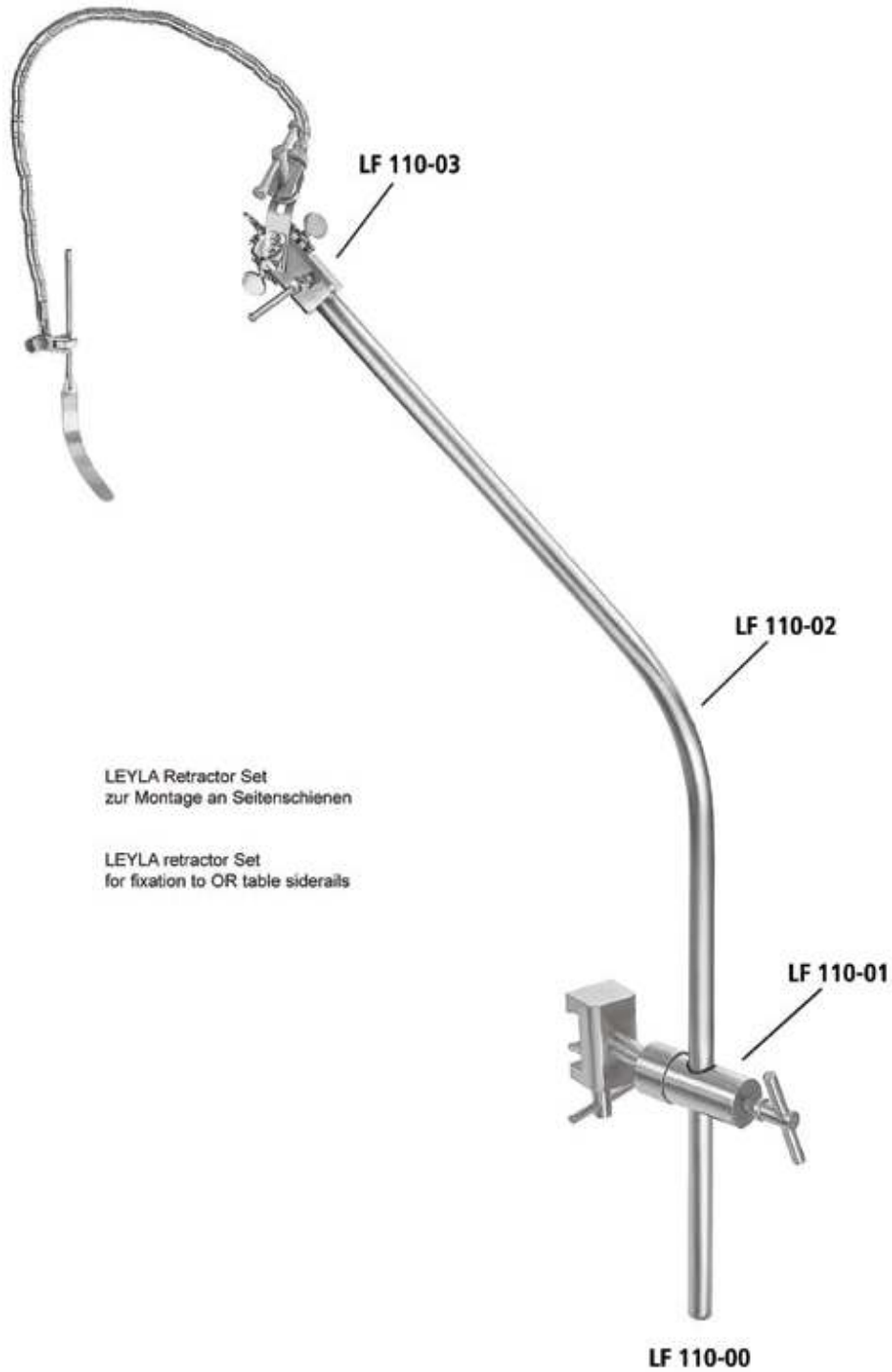

Leyla Ekartör
Self-Retaining Retractors, for Skull Mounting
Retraktoren zur Fixation am Schädel

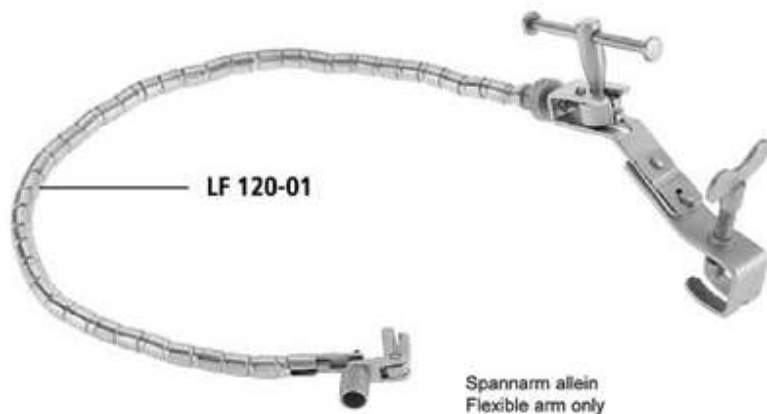

LF 120-02
Fixiervorrichtung für 1 Arm zum Festschrauben am Schädel
Fixation base for 1 arm at skull



LF 120-03
Fixiervorrichtung für 2 Arme zum Festschrauben am Schädel
Fixation base for 2 arms at skull



LF 120-05
Halter für flache Hirnspatel
Holder for flat brain spatula



LF 120-04
Fixiervorrichtung für 1 Arm zum Festschrauben am Starrarm
Fixation base for 1 arm at rigid arm



LF 120-06
Halter für Hirnspatel mit rundem Schaft
Holder for brain spatula with round stem

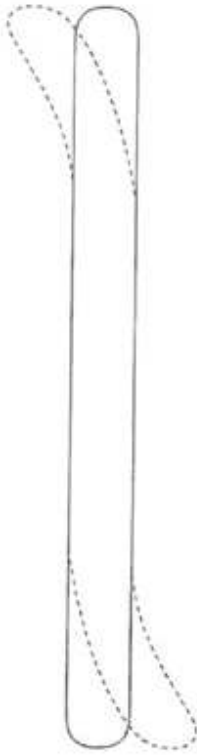

biegsam
malleable

RIBBON

6 x 200 mm	LF 130-01
7 x 200 mm	LF 130-02
9 x 200 mm	LF 130-03
12 x 200 mm	LF 130-04
17 x 200 mm	LF 130-05
20 x 200 mm	LF 130-06
25 x 200 mm	LF 130-07
25 x 250 mm	LF 130-08



biegsam
malleable

RIBBON

13 x 330 mm	LF 131-01
19 x 330 mm	LF 131-02
25 x 330 mm	LF 131-03
30 x 330 mm	LF 131-04
32 x 330 mm	LF 131-05
40 x 330 mm	LF 131-06
45 x 330 mm	LF 131-07
50 x 330 mm	LF 131-08
64 x 330 mm	LF 131-09
75 x 330 mm	LF 131-10



biegsam
malleable

SCOVILLE

10/13 x 200 mm	LF 132-01
16/19 x 200 mm	LF 132-02



biegsam
malleable

AACHEN

7/8 x 200 mm	LF 133-01
10/11 x 200 mm	LF 133-02
13/14 x 200 mm	LF 133-03
16/17 x 200 mm	LF 133-04
19/20 x 200 mm	LF 133-05
22/25 x 200 mm	LF 133-06



biegsam
malleable

0,90 mm

CAIRNS

6 x 200 mm	LF 134-01
8 x 200 mm	LF 134-02
10 x 200 mm	LF 134-03
11 x 200 mm	LF 134-04
13 x 200 mm	LF 134-05
16 x 200 mm	LF 134-06
19 x 200 mm	LF 134-07
25 x 200 mm	LF 134-08

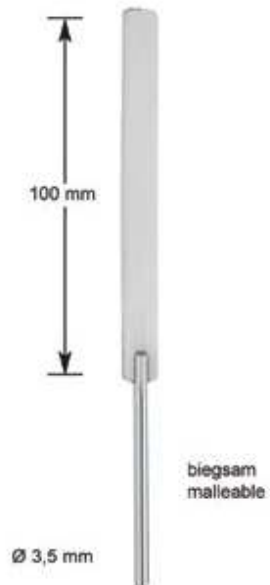

HEIFETZ	
8 x 155 mm	LF 135-01
11 x 155 mm	LF 135-02
14 x 155 mm	LF 135-03
17 x 155 mm	LF 135-04

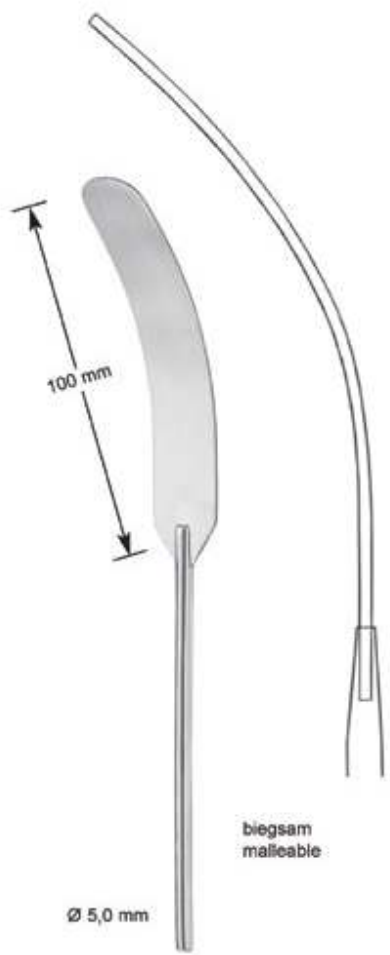

HEIFETZ	
8 x 200 mm	LF 136-01
11 x 200 mm	LF 136-02
14 x 200 mm	LF 136-03
17 x 200 mm	LF 136-04
20 x 200 mm	LF 136-05



biegsam
malleable

CUSHING

7/9 x 180 mm	LF 137-01
11/13 x 180 mm	LF 137-02
15/18 x 180 mm	LF 137-03
18/22 x 180 mm	LF 137-04



konvex
convex

OLIVECRONA

7/9 x 180 mm	LF 138-01
11/13 x 180 mm	LF 138-02
15/18 x 180 mm	LF 138-03
18/22 x 180 mm	LF 138-04



konkav
concave

OLIVECRONA

7/9 x 180 mm	LF 139-01
11/13 x 180 mm	LF 139-02
15/18 x 180 mm	LF 139-03
18/22 x 180 mm	LF 139-04





MA 102-10 10.5 cm MA 102-11 11.5 cm MA 102-13 13 cm MA 102-14 14.5 cm MA 102-15 15 cm MA 102-16 16.5 cm MA 102-17 17.5 cm MA 102-18 18.5 cm



MA 103-11 11.5 cm MA 103-13 13 cm MA 103-14 14.5 cm MA 103-15 15 cm MA 103-16 16.5 cm MA 103-17 17.5 cm MA 103-18 18.5 cm



fein
 delicate



14,5 cm/5¾"

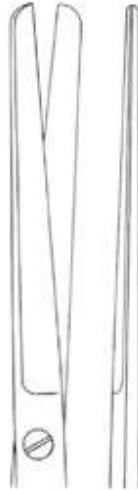

MA 106-14

stumpf/stumpf
 blunt/blunt



MA 108-14

spitz/stumpf
 sharp/blunt



MA 110-14

spitz/spitz
 sharp/sharp

fein
 delicate



14,5 cm/5¾"



MA 107-14

stumpf/stumpf
 blunt/blunt



MA 109-14

spitz/stumpf
 sharp/blunt



MA 111-14

spitz/spitz
 sharp/sharp

Diseksiyon Makasları
Dissecting Scissors
Präparierscheren

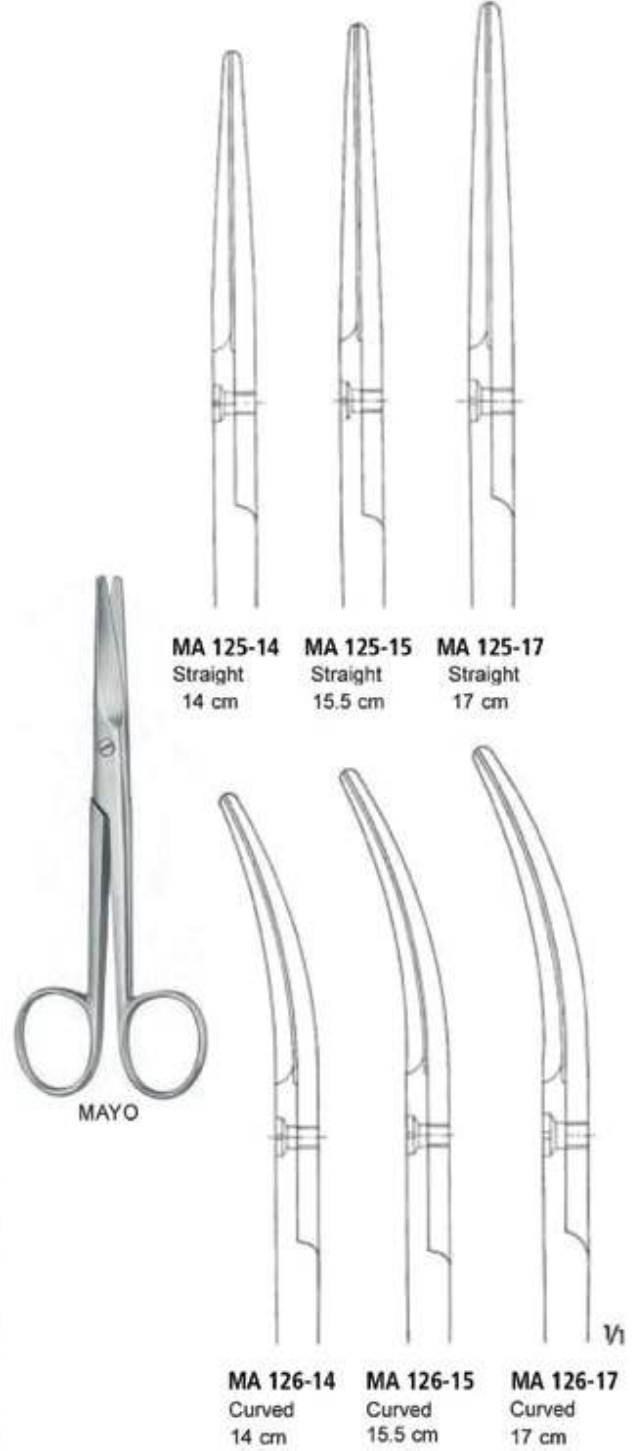
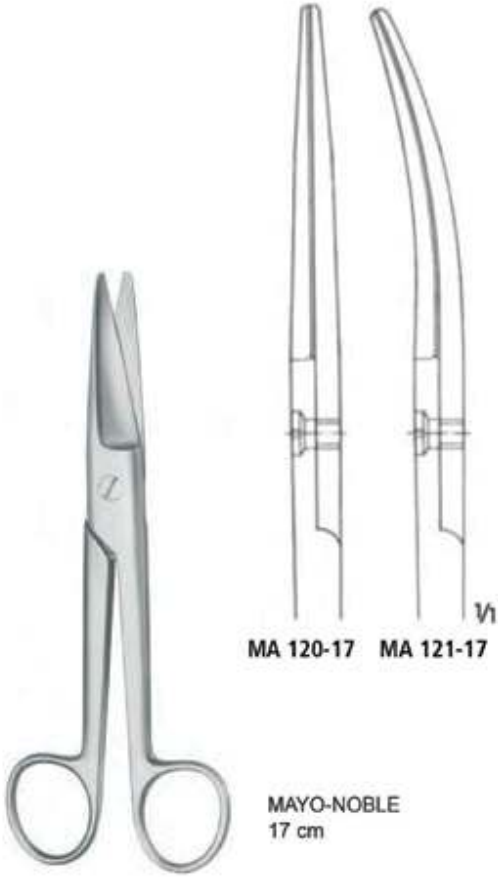



KELLY
16 cm/6¼"

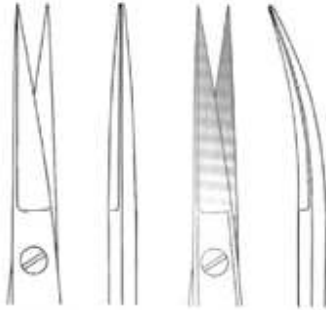

MA 134-16

MA 135-16



METZENBAUM
14 cm/5½"

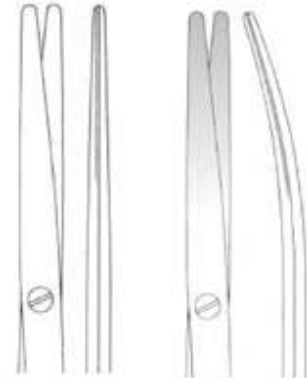

MA 149-14

MA 150-14



METZENBAUM FINO
14 cm/5½"

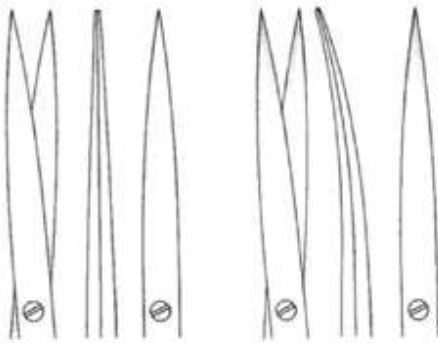

MA 153-14

MA 154-14



METZENBAUM
11,5 cm/4½"

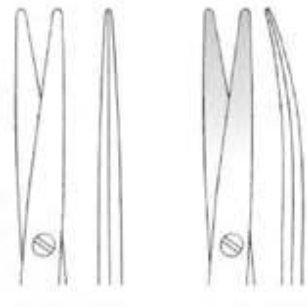

MA 155-11

MA 156-11

Diseksiyon Makasları
Dissecting Scissors
Präparierscheren



METZENBAUM

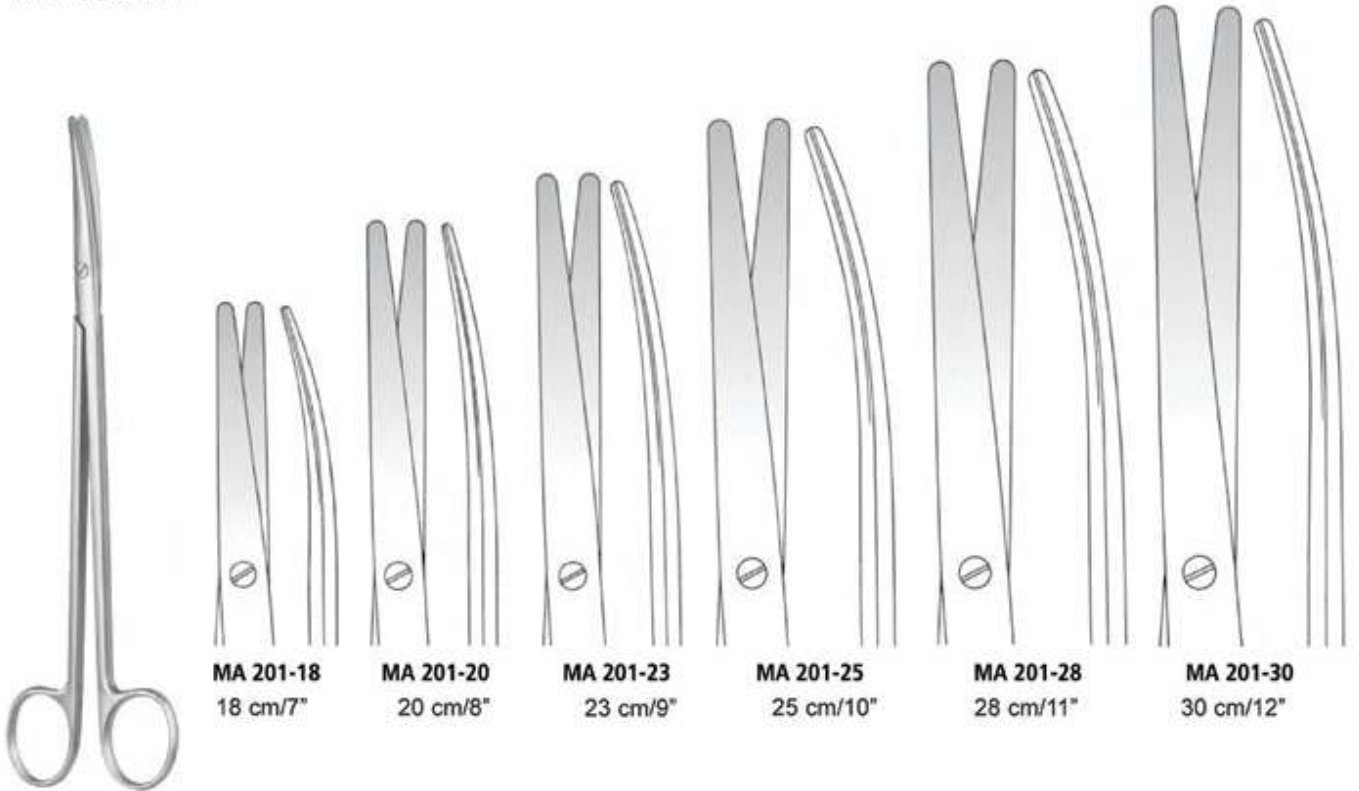
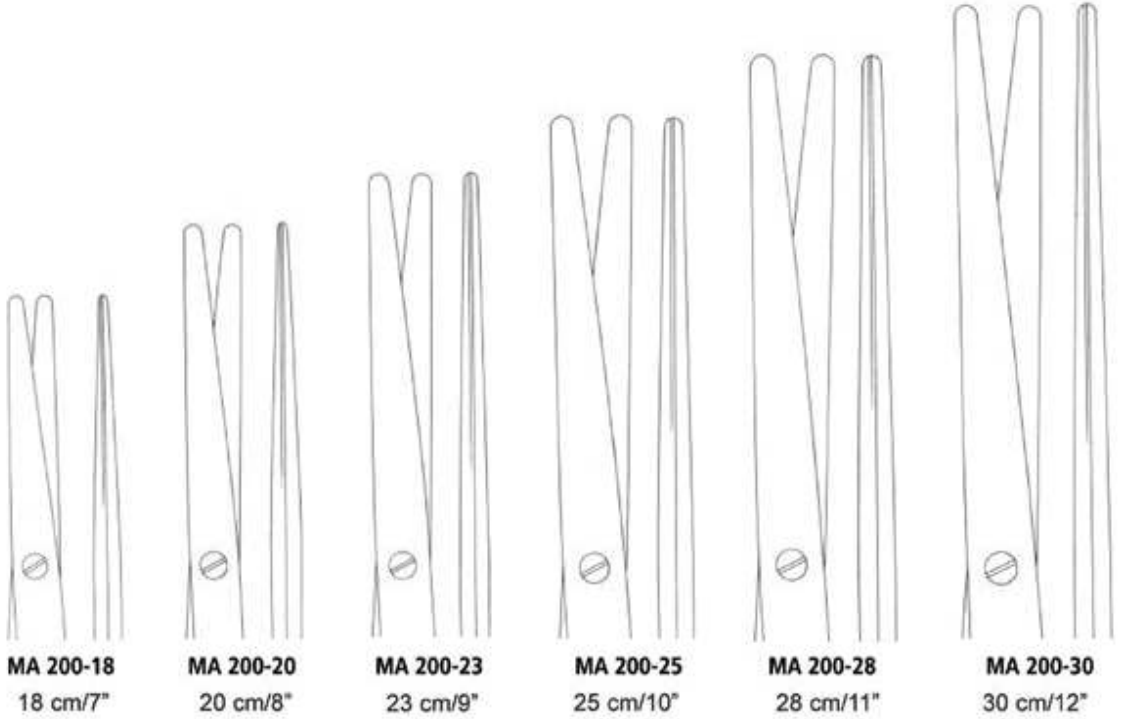

METZENBAUM



METZENBAUM FINO

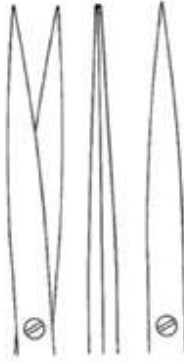

MA 204-18
18 cm/7"

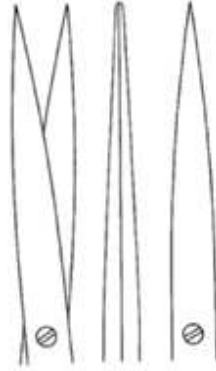

MA 204-20
20 cm/8"

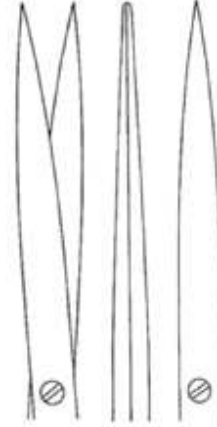

MA 204-23
23 cm/9"



METZENBAUM FINO

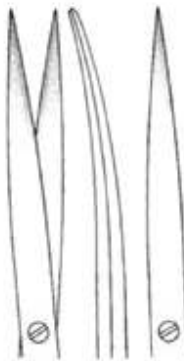

MA 205-18
18 cm/7"

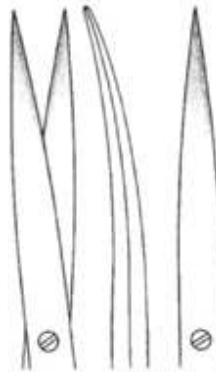

MA 205-20
20 cm/8"



MA 205-23
23 cm/9"

Diseksiyon Makasları
Dissecting Scissors
Präparierscheren

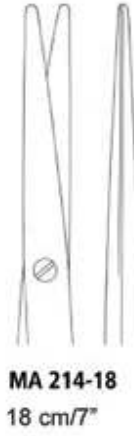

Nerv-Präparierschere
 Nerve dissecting scissors



MA 218-15
 15 cm/6"



MA 219-15
 15 cm/6"



LEXER
 16 cm/6¼"

MA 220-16



MA 221-16

Strabismusscheren
 Strabismus Scissors



11 cm/4¼"



MA 224-10

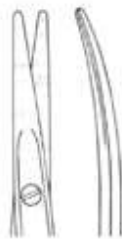

MA 225-10

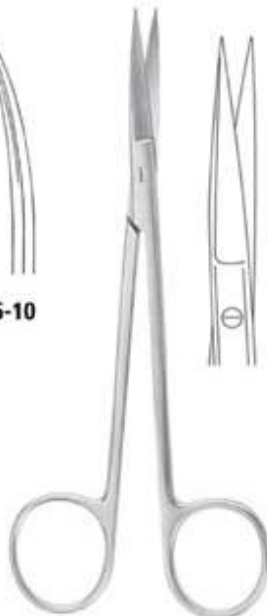

SANVENERO
 14 cm/5½"



MA 226-14



MA 227-14



JOSEPH
 14 cm/5½"



MA 228-14



MA 229-14

Diseksiyon Makasları
Dissecting Scissors
Präparierscheren



KILNER

12 cm/4¾" MA 231-12
15 cm/6" MA 231-15



MA 232-15

REYNOLDS
15 cm/6"



MA 233-15
15 cm/6"

REYNOLDS

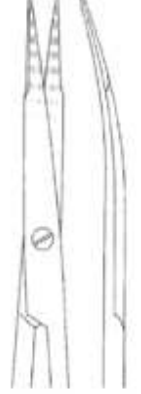

MA 233-18
18 cm/7"



POTTS-SMITH



25°

19 cm/7½" MA 234-25

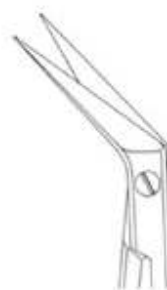

40°

MA 234-45



60°

MA 234-60



DE BAKEY

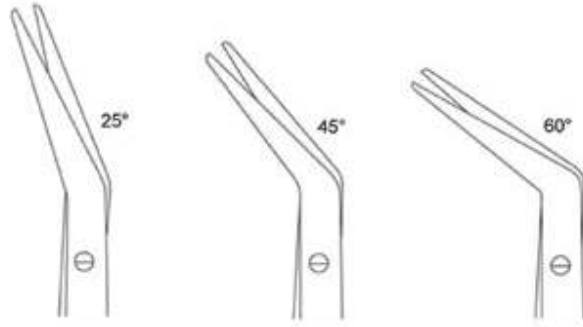

	25°	45°	60°
16 cm/6¼"	MA 235-16	MA 236-16	MA 237-16
23 cm/9"	MA 235-23	MA 236-23	MA 237-23
28 cm/11"	MA 235-28	MA 236-28	MA 237-28



DIETRICH

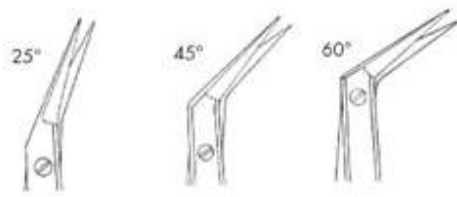

16 cm/6¼"	MA 238-01	MA 238-02	MA 238-03
18 cm/7"	MA 239-01	MA 239-02	MA 239-03



16 cm/6¼"	MA 238-04	MA 238-05
18 cm/7"	MA 239-04	MA 239-05



MA 240-19



DIETRICH
18 cm/7"

Damar Makasları
Vessel Scissors
Gefäßscheren



55°

MA 241-19

POTTS-SMITH
18,5 cm/7¼"



geknöpft
probe pointed

STRULLY
MA 245-22
22 cm/8¾"



DANDY
MA 247-17
17 cm/6¾"

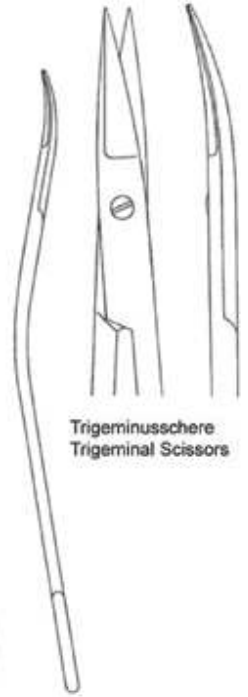

Trigeminusschere
Trigeminal Scissors



MA 250-15

DE BAKEY
15,5 cm/6"



MA 251-15

DE BAKEY
15,5 cm/6"

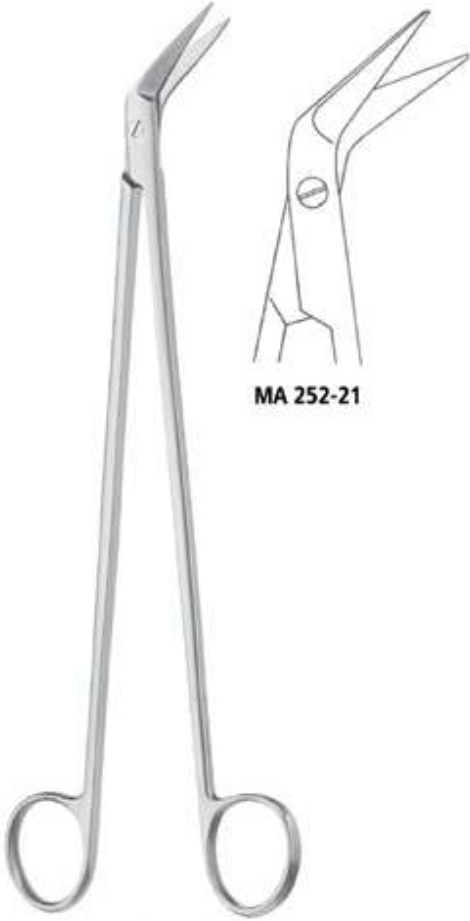

MA 252-21

POTS DE MARTEL
 21 cm/8¼"



MA 253-21

MILLS
 22 cm/8¾"

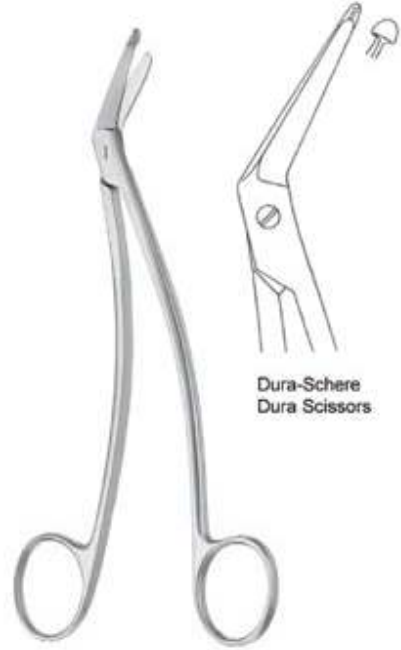

Dura-Schere
Dura Scissors

SCHMIEDEN TAYLOR
MA 254-17
 17 cm/6¾"



MA 255-17
 sehr fein
 very delicate



MA 255-18
 fein
 delicate

TOENNIS ADSON
 17,5 cm/7"

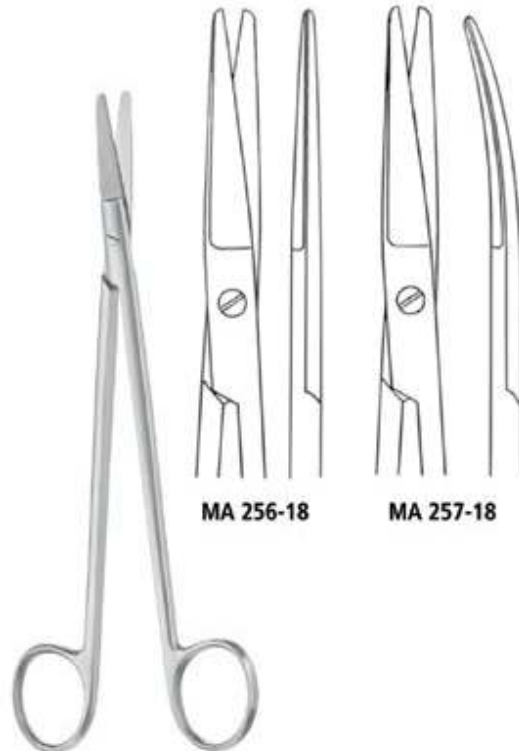

MA 256-18

MA 257-18

TOENNIS ADSON
 18 cm/7"

gezahnt
toothed



Triginusschere
Trigeminal Scissors

OLIVECRONA
MA 309-23
23 cm/9"

gezahnt
toothed



GORNEY

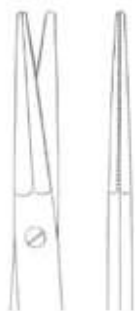

MA 350-12
12,5 cm/5"



MA 350-19
19,5 cm/7¾"

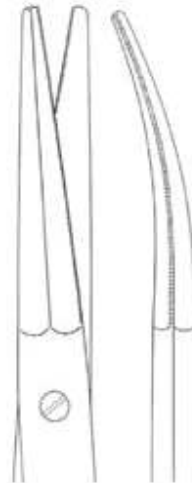

MA 351-19
19,5 cm/7¾"



Arteriotomie-Schere
Arteriotomy scissors



DEBAKEY
MA 352-17
17,5 cm/7"

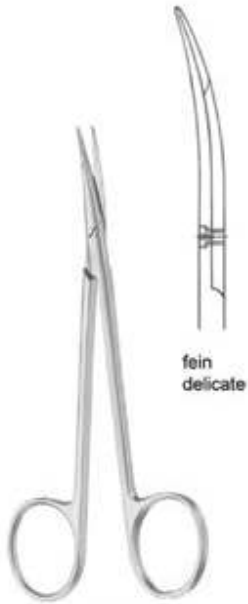

JAMESON WERBER
MA 353-13
 13 cm/5"



MA 354-15
 15 cm/6"
 fein delicate

MA 354-18
 18 cm/7"

JAMESON



WAGNER
MA 460-03
 12 cm/6 3/4"



WAGNER
MA 461-03
 12 cm/6 3/4"



Fadenführungsschere
Suture carrying scissors

LITTLER
 12 cm/4 3/4" **MA 542-11**
 14 cm/5 1/2" **MA 542-14**



IRIS
MA 559-11
 11,5 cm/4½"

IRIS
MA 560-11
 11,5 cm/4½"



IRIS
 9 cm/3½" **MA 561-09**
 10,5 cm/4¼" **MA 561-10**
 11,5 cm/4½" **MA 561-11**



IRIS
 9 cm/3½" **MA 562-09**
 10,5 cm/4¼" **MA 562-10**
 11,5 cm/4½" **MA 562-11**



spitz/spitz
 sharp/sharp

STEVENS
MA 573-10
 10,5 cm/4½"



spitz/spitz
 sharp/sharp

STEVENS
MA 574-10
 10,5 cm/4½"

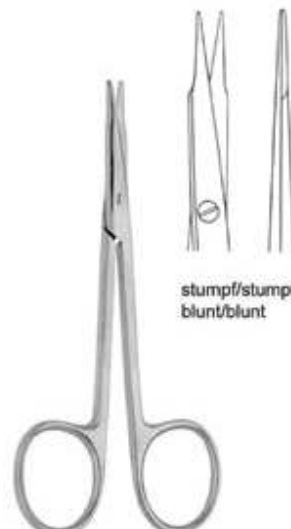

stumpf/stumpf
 blunt/blunt

STEVENS
MA 575-10
 10,5 cm/4½"

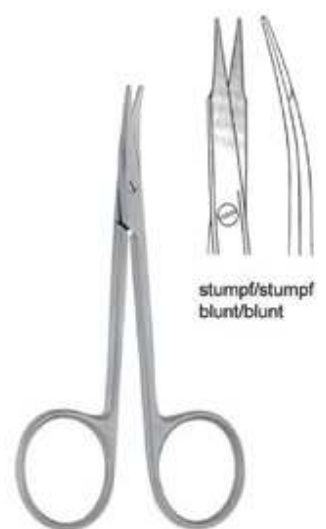

stumpf/stumpf
 blunt/blunt

STEVENS
MA 576-10
 10,5 cm/4½"

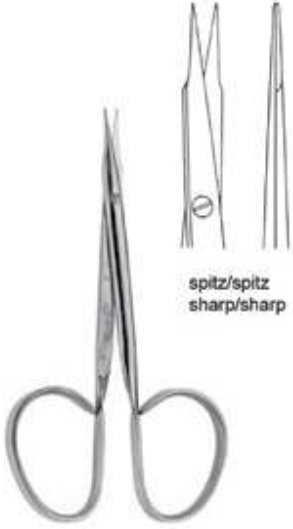

spitz/spitz
 sharp/sharp

STEVENS
MA 577-10
 10,5 cm/4½"



spitz/spitz
 sharp/sharp

STEVENS
MA 578-10
 10,5 cm/4½"

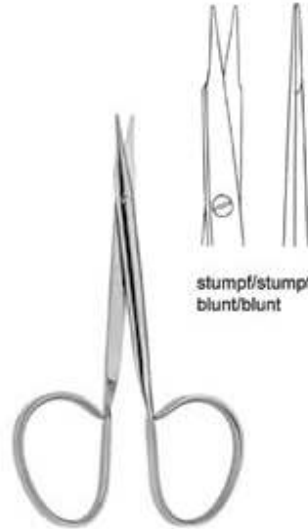

stumpf/stumpf
 blunt/blunt

STEVENS
MA 579-10
 10,5 cm/4½"

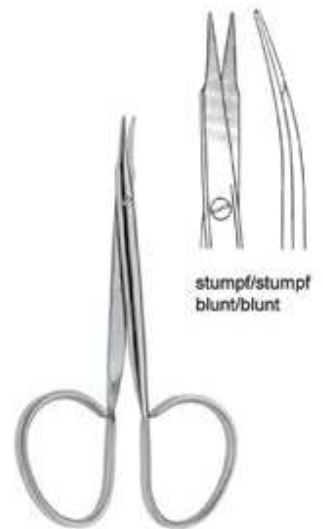

stumpf/stumpf
 blunt/blunt

STEVENS
MA 580-10
 10,5 cm/4½"



Draht Scheren
 Wire Cutting Scissors

½
UNIVERSAL
MA 604-12
 12 cm/4¾"



LISTER

14 cm/5½" **MA 636-14**
 18 cm/7" **MA 636-18**
 20 cm/8" **MA 636-20**

Hard Metal Edged



MA 850-14
14.5 cm



MA 850-15
15 cm



MA 850-16
16.5 cm



MA 850-18
17.5 cm

1/1



MA 851-14
14.5 cm



MA 851-15
15 cm



MA 851-16
16.5 cm



MA 851-18
17.5 cm

1/1

Hard Metal Edged

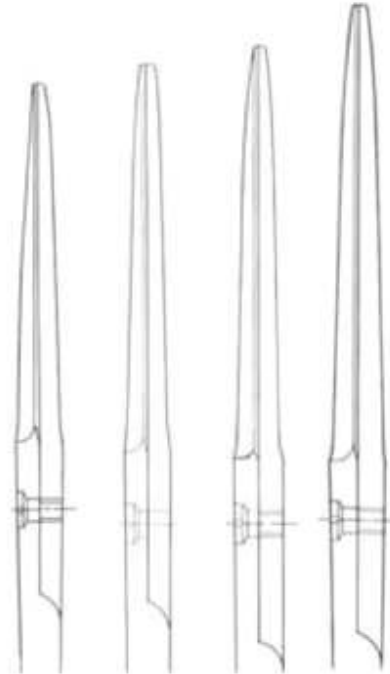

MA 852-14 14.5 cm **MA 852-15** 15 cm **MA 852-16** 16.5 cm **MA 852-18** 17.5 cm



MA 853-14 14.5 cm **MA 853-15** 15 cm **MA 853-16** 16.5 cm **MA 853-18** 17.5 cm

Hard Metal Edged

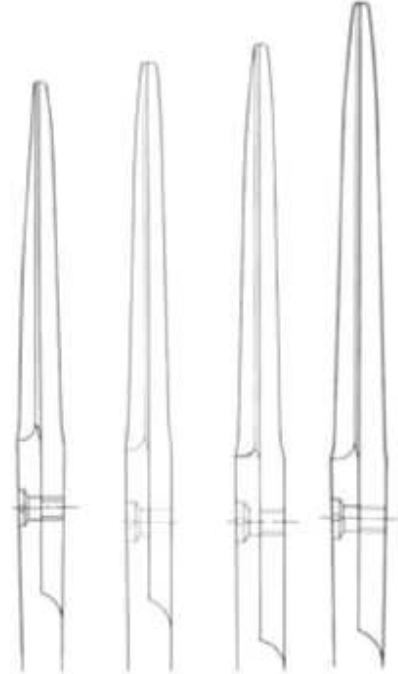

MA 854-14 14.5 cm
MA 854-15 15 cm
MA 854-16 16.5 cm
MA 854-18 17.5 cm



MA 855-14 14.5 cm
MA 855-15 15 cm
MA 855-16 16.5 cm
MA 855-18 17.5 cm

Hard Metal Edged



MAYO

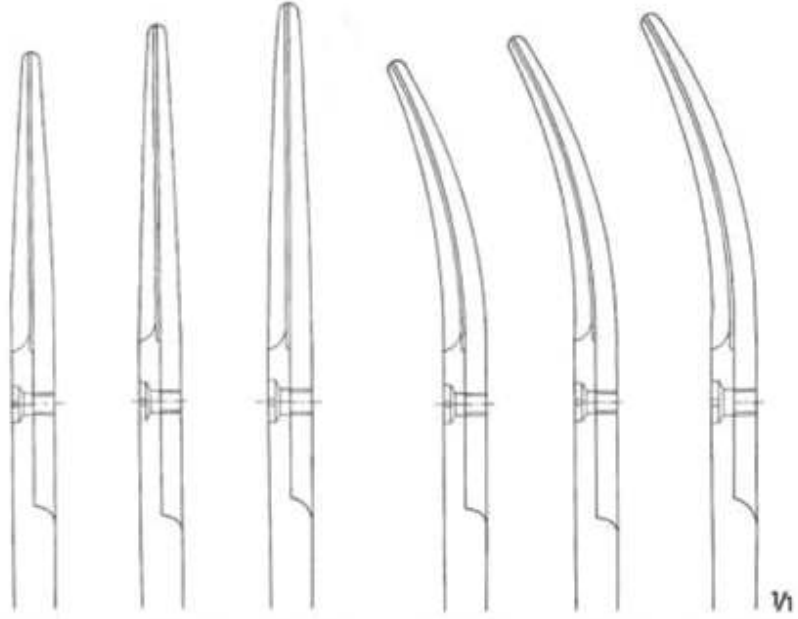

MA 856-14	MA 856-15	MA 856-17	MA 857-14	MA 857-15	MA 857-17
Straight	Straight	Straight	Curved	Curved	Curved
14 cm	15.5 cm	17 cm	14 cm	15.5 cm	17 cm



MAYO-STILLE

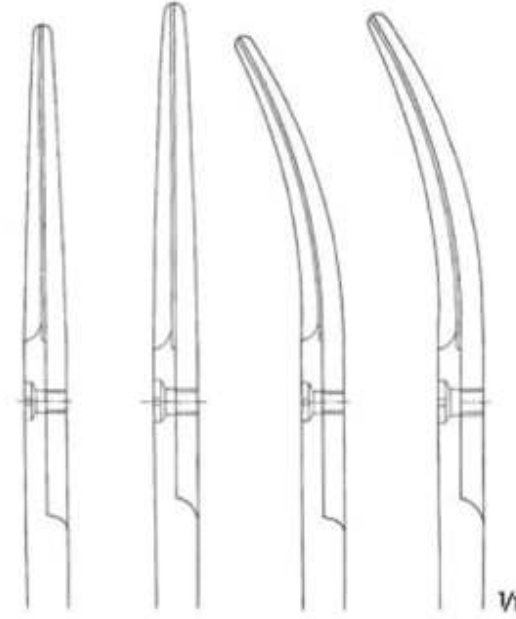

MA 859-15	MA 859-17	MA 860-15	MA 860-17
Straight	Straight	Curved	Curved
15.5 cm	17 cm	15.5 cm	17 cm

Diseksiyon Makasları
Dissecting Scissors
Präparierscheren

Hard Metal Edged



MA 865-11

MA 866-11

Strabismusscheren
Strabismus Scissors

11 cm/4¼"



MA 867-14

MA 868-14

METZENBAUM
14 cm/5½"



METZENBAUM

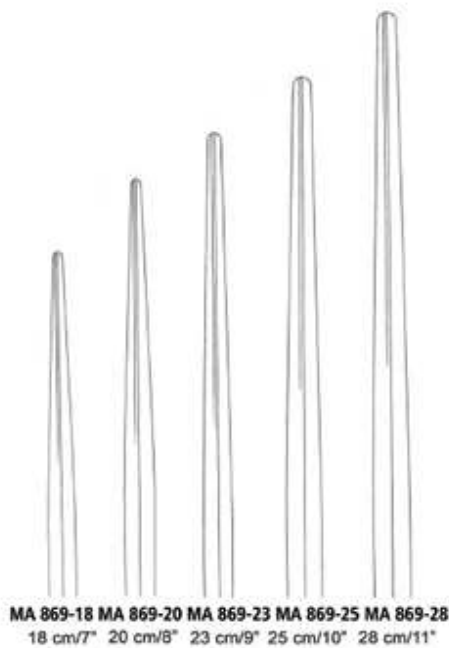

MA 869-18 MA 869-20 MA 869-23 MA 869-25 MA 869-28
18 cm/7" 20 cm/8" 23 cm/9" 25 cm/10" 28 cm/11"

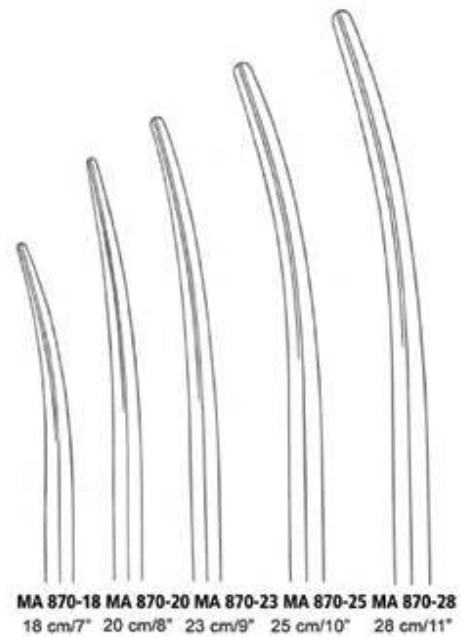

MA 870-18 MA 870-20 MA 870-23 MA 870-25 MA 870-28
18 cm/7" 20 cm/8" 23 cm/9" 25 cm/10" 28 cm/11"

Hard Metal Edged



LEXER
 16 cm/6 1/4"

MA 873-16

MA 874-16



METZENBAUM FINO

MA 875-14

MA 876-14



METZENBAUM FINO

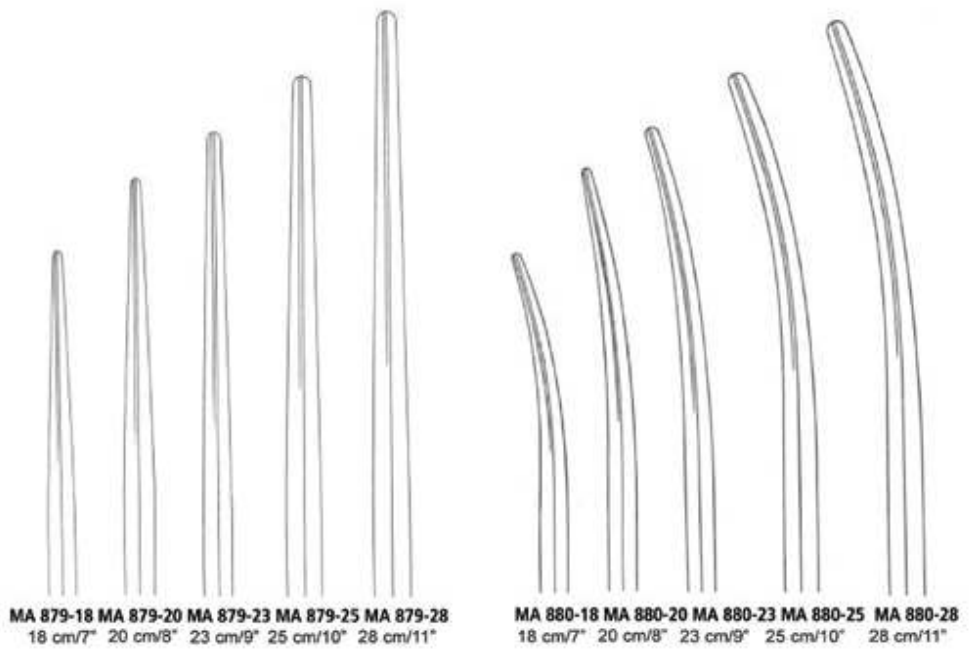

Hard Metal Edged



METZENBAUM FINO

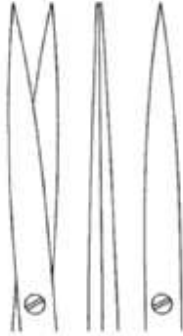

MA 877-14
14,5 cm/5¾"

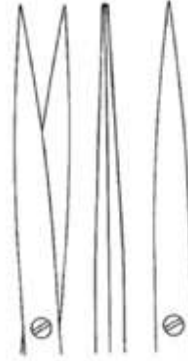

MA 881-18
18 cm/7"

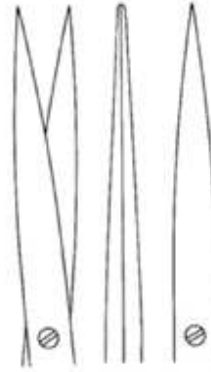

MA 881-20
20 cm/8"

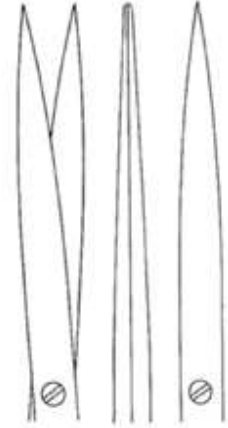

MA 881-23
23 cm/9"



METZENBAUM FINO



MA 878-14
14,5 cm/5¾"

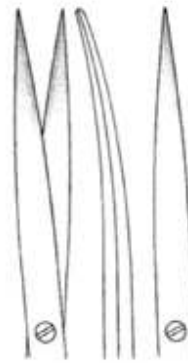

MA 882-18
18 cm/7"



MA 882-20
20 cm/8"

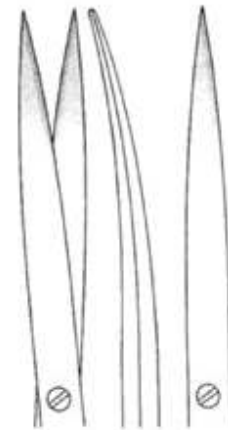

MA 882-23
23 cm/9"

Hard Metal Edged



TOENNIS-ADSON
MA 883-17
 17 cm/6¾"



GOLDMAN FOX
MA 884-13
 13 cm/5"



GOLDMAN FOX
MA 885-13
 13 cm/5"



IRIS
 11,5 cm/4½"



UNIVERSAL
MA 889-12
 12 cm/4¾"

Eine Schneide gezahnt
 One toothed cutting edge



LISTER
 14 cm/5½" **MA 890-14**
 18 cm/7" **MA 890-18**
 20 cm/8" **MA 890-20**

Diseksiyon Makasları
Dissecting Scissors
Präparierscheren

SUPERCUT

Hard Metal Edged



METZENBAUM

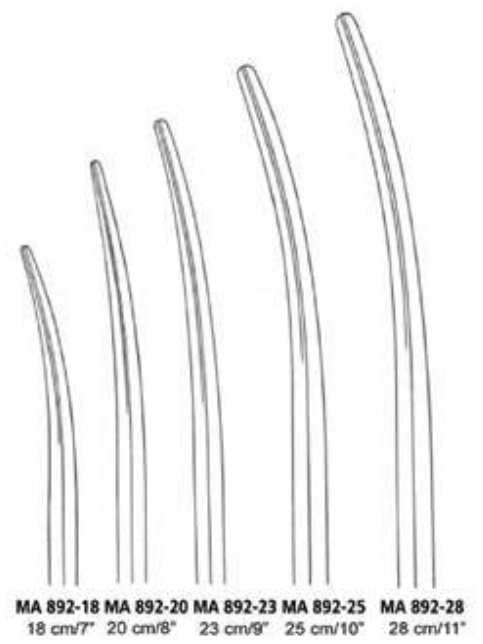
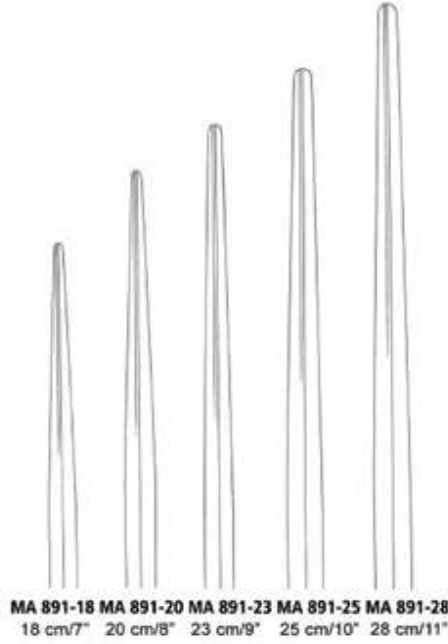

METZENBAUM

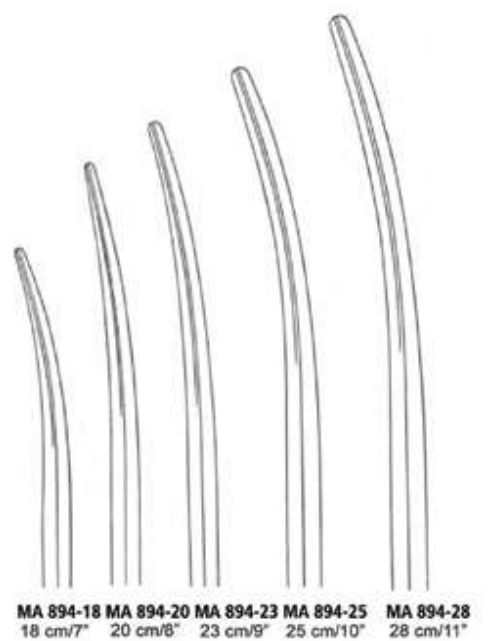
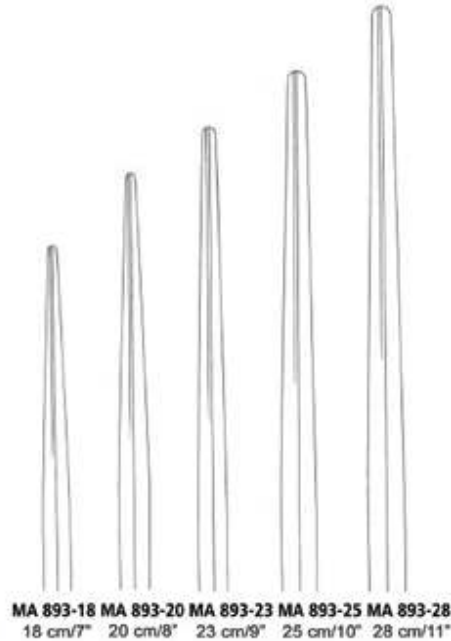

Hard Metal Edged



Ceramic Coating
Keramikbeschichtung



METZENBAUM

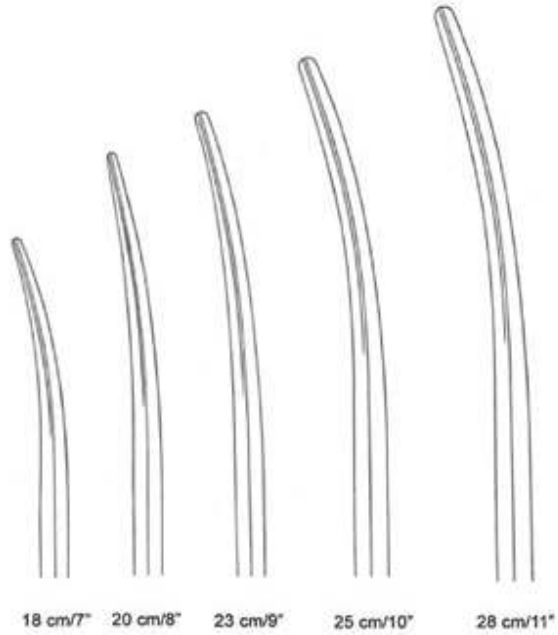
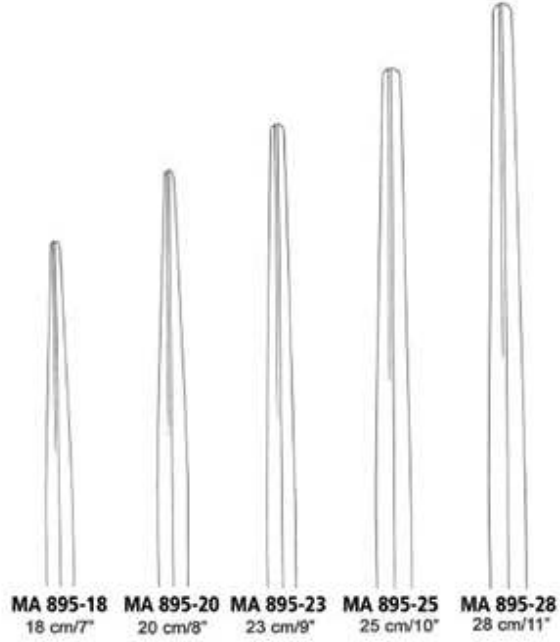

Mikro Makaslar
Micro Scissors
Mikro Scheren



CASTROVIEJO
 10 cm/4"



MA 913-01
 spitz/spitz
 sharp/sharp



MA 913-02
 stumpf/stumpf
 blunt/blunt



VANNAS
 8 cm/3¼"



MA 916-01



MA 916-02



MA 916-03



Mikro-Präparierschere
Micro dissecting scissors



14,5 cm/5¾"
 18 cm/7"
 23 cm/9"

MA 947-01
MA 947-02
MA 947-03

spitz/spitz
 sharp/sharp



MA 947-04
MA 947-05
MA 947-06

spitz/spitz
 sharp/sharp



MA 947-07
MA 947-08

stumpf/stumpf
 blunt/blunt



	YASARGIL	YASARGIL
12 cm/4¾"	MA 969-01	MA 970-01
16 cm/6¼"	MA 969-02	MA 970-02
18,5 cm/7¼"	MA 969-03	MA 970-03



	VANNAS	VANNAS	VANNAS
12 cm/4¾"	MA 971-01	MA 972-01	MA 973-01
16 cm/6¼"	MA 971-02	MA 972-02	



Venenschere
Vein scissors

BIEMER
MA 974-01
13 cm/5"

Mikro Makaslar
Micro Scissors
Mikro Scheren



18 cm/7"

spitz
sharp

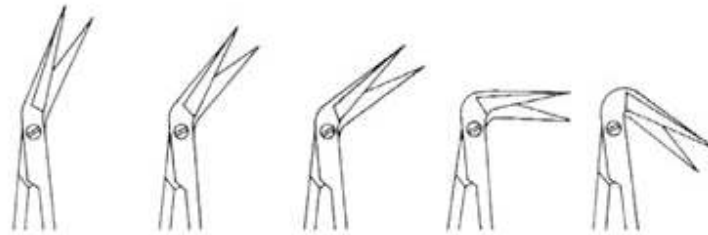

25° 45° 60° 90° 125°

14 mm **MA 975-01** **MA 975-02** **MA 975-03** **MA 975-04** **MA 975-05**

1 Blatt geknöpft
1 probe-pointed blade

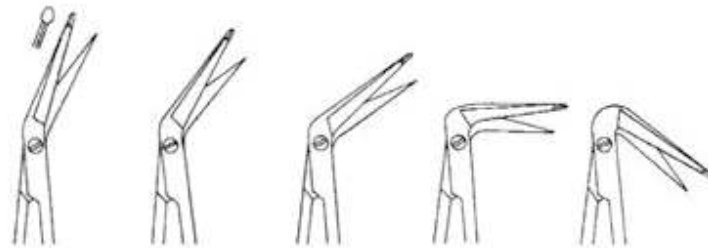

25° 45° 60° 90° 125°

Flachgriff
Flat handle

14 mm **MA 976-01** **MA 976-02** **MA 976-03** **MA 976-04** **MA 976-05**



16,5 cm/6½"

spitz
sharp



25°



45°



60°



90°



125°

14 mm

MA 977-01

MA 977-02

MA 977-03

MA 977-04

MA 977-05

1 Blatt geknöpft
1 probe-pointed blade



25°



45°



60°



90°



125°

14 mm

MA 978-01

MA 978-02

MA 978-03

MA 978-04

MA 978-05

Mikro Makaslar
Micro Scissors
Mikro Scheren

iDOL
CERRAHİ ALETLER
www.idolcerrahi.com



YASARGIL

Mikro-Präparierschere
Micro dissecting scissors



16,5 cm/6½" MA 979-01
20 cm/8" MA 980-01

MA 979-02
MA 980-02

MA 980-03



YASARGIL

gezahnt
toothed



22,5 cm/9"

MA 981-01



MA 981-02



MA 981-03



MA 981-04



VANNAS
MA 981-05
22,5 cm/9"



VANNAS
MA 981-06
22,5 cm/9"

Mikro Makaslar
Micro Scissors
Mikro Scheren

iDOL
CERRAHİ ALETLER
www.idolcerrahi.com



Schneide 10mm
 Cutting edge 10mm

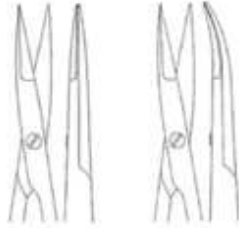

15 cm/6"	MA 984-15	MA 985-15
18 cm/7"	MA 984-18	MA 985-18
21 cm/8¼"	MA 984-21	MA 985-21
23 cm/9"	MA 984-23	MA 985-23

Schneide 10mm
 Cutting edge 10mm

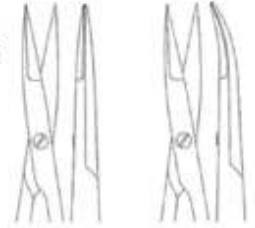

15 cm/6"	MA 986-15	MA 987-15
18 cm/7"	MA 986-18	MA 987-18
21 cm/8¼"	MA 986-21	MA 987-21
23 cm/9"	MA 986-23	MA 987-23



Rundgriff
 Round handle



Flachgriff
 Flat handle

Laminektomi Ekartorleri
Laminectomy Retractors
Laminektemiesperrer



mit Sperre
with ratchet

INGE

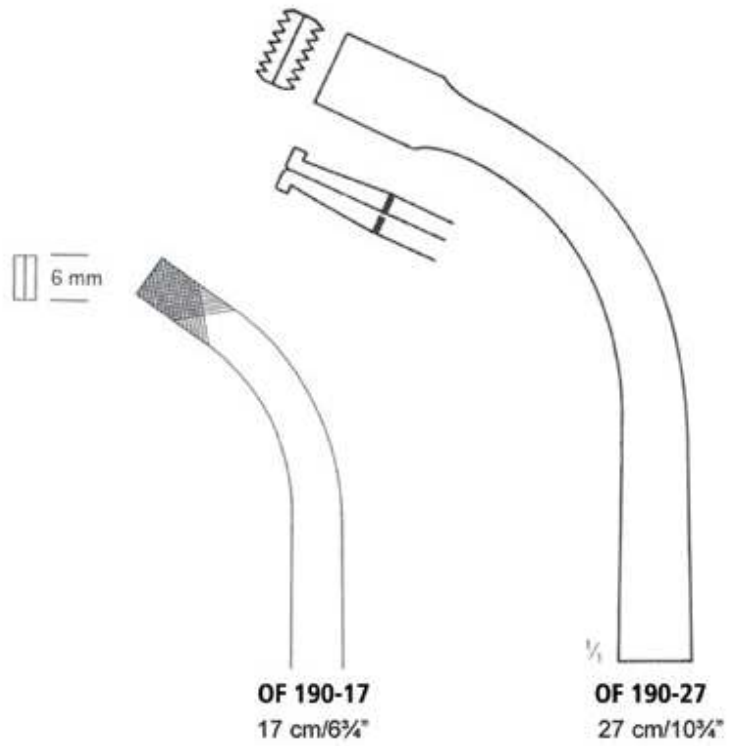

6 mm

OF 190-17
17 cm/6 $\frac{3}{4}$ "

OF 190-27
27 cm/10 $\frac{3}{4}$ "



20 mm

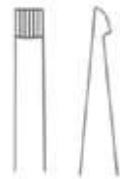

OF 191-13

mit Sperre
with ratchet

CLOWARD
15 cm/6"



OF 191-15

mit Sperre
with ratchet

CLOWARD
16 cm/6 $\frac{1}{4}$ "

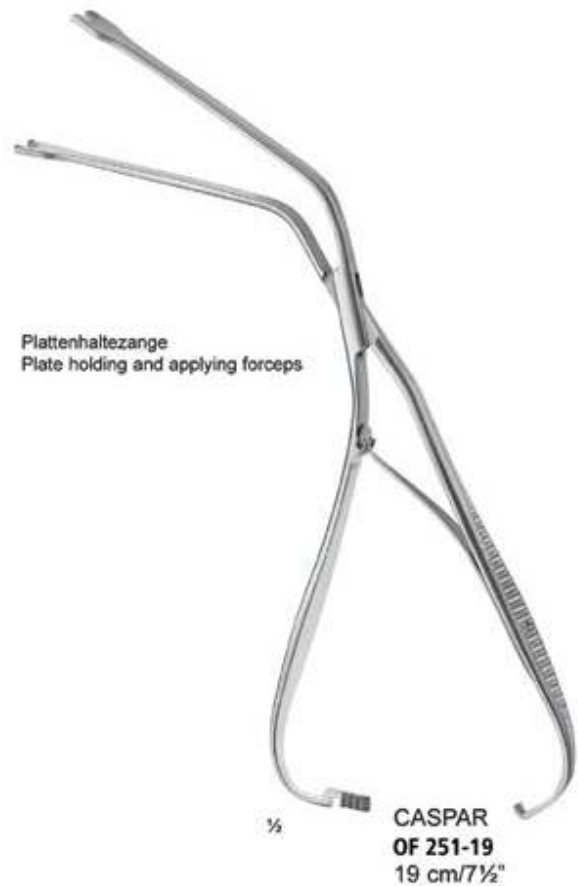
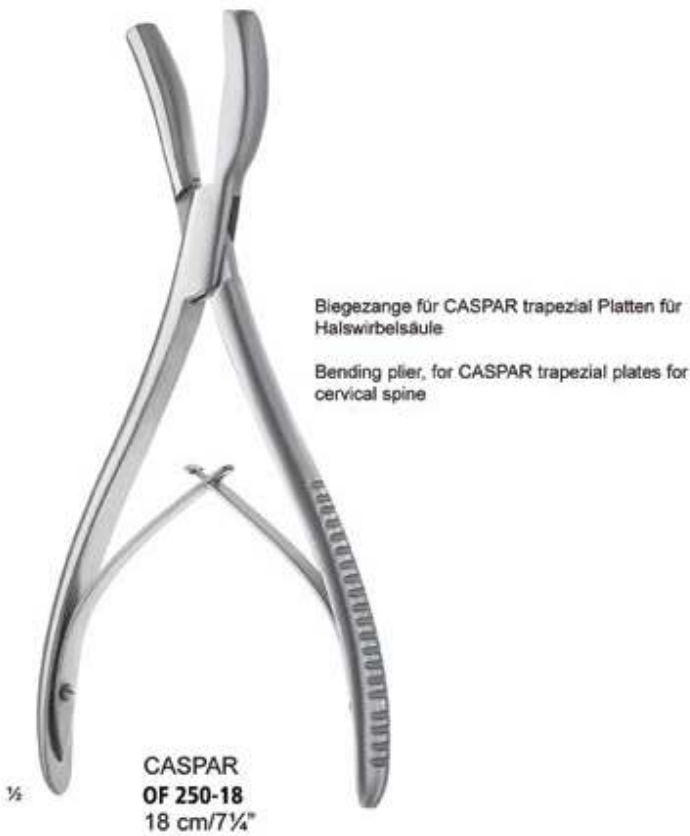

Kafa Traksiyon Aletleri
Skull Traction Tongs
Schädelhalter



**CRUTCHFIELD
 OF 300-01**

kleines Modell
 small pattern



**CRUTCHFIELD
 OF 300-02**

mittleres Modell
 medium pattern



**CRUTCHFIELD
 OF 300-03**
 7 cm/2 3/4"
 Ø 3,5 mm

Vorbohrer
 Drill Point



**CRUTCHFIELD
 OF 300-04**
 7 cm/2 3/4"
 Ø 5,0 mm

Vorbohrer
 Drill Point



OF 300-05
 großes Modell
 large pattern



OF 300-06
 Ersatzdom
 Spare pin



90°

180 mm / 7"	1	OF 501-01
	2	OF 501-02
	3	OF 501-03
	4	OF 501-04
	5	OF 501-05
200 mm / 8"	1	OF 502-01
	2	OF 502-02
	3	OF 502-03
	4	OF 502-04
	5	OF 502-05
230 mm / 9"	1	OF 503-01
	2	OF 503-02
	3	OF 503-03
	4	OF 503-04
	5	OF 503-05



40°

180 mm / 7"	1	OF 505-01
	2	OF 505-02
	3	OF 505-03
	4	OF 505-04
	5	OF 505-05
200 mm / 8"	1	OF 506-01
	2	OF 506-02
	3	OF 506-03
	4	OF 506-04
	5	OF 506-05
230 mm / 9"	1	OF 507-01
	2	OF 507-02
	3	OF 507-03
	4	OF 507-04
	5	OF 507-05

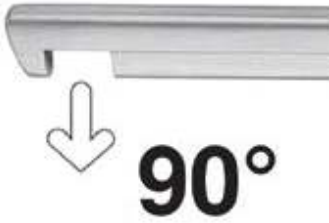

180 mm / 7"	1	OF 512-01
	2	OF 512-02
	3	OF 512-03
	4	OF 512-04
	5	OF 512-05
200 mm / 8"	1	OF 513-01
	2	OF 513-02
	3	OF 513-03
	4	OF 513-04
	5	OF 513-05
230 mm / 9"	1	OF 514-01
	2	OF 514-02
	3	OF 514-03
	4	OF 514-04
	5	OF 514-05



180 mm / 7"	1	OF 519-01
	2	OF 519-02
	3	OF 519-03
	4	OF 519-04
	5	OF 519-05
200 mm / 8"	1	OF 520-01
	2	OF 520-02
	3	OF 520-03
	4	OF 520-04
	5	OF 520-05
230 mm / 9"	1	OF 521-01
	2	OF 521-02
	3	OF 521-03
	4	OF 521-04
	5	OF 521-05



Ceramic Coating
Keramikbeschichtung



90°

180 mm / 7"	1	OF 501-01 B
	2	OF 501-02 B
	3	OF 501-03 B
	4	OF 501-04 B
	5	OF 501-05 B
200 mm / 8"	1	OF 502-01 B
	2	OF 502-02 B
	3	OF 502-03 B
	4	OF 502-04 B
	5	OF 502-05 B
230 mm / 9"	1	OF 503-01 B
	2	OF 503-02 B
	3	OF 503-03 B
	4	OF 503-04 B
	5	OF 503-05 B



40°

180 mm / 7"	1	OF 505-01 B
	2	OF 505-02 B
	3	OF 505-03 B
	4	OF 505-04 B
	5	OF 505-05 B
200 mm / 8"	1	OF 506-01 B
	2	OF 506-02 B
	3	OF 506-03 B
	4	OF 506-04 B
	5	OF 506-05 B
230 mm / 9"	1	OF 507-01 B
	2	OF 507-02 B
	3	OF 507-03 B
	4	OF 507-04 B
	5	OF 507-05 B



Ceramic Coating
Keramikbeschichtung

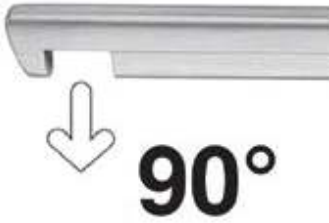

180 mm / 7"	1	OF 512-01 B
	2	OF 512-02 B
	3	OF 512-03 B
	4	OF 512-04 B
	5	OF 512-05 B
200 mm / 8"	1	OF 513-01 B
	2	OF 513-02 B
	3	OF 513-03 B
	4	OF 513-04 B
	5	OF 513-05 B
230 mm / 9"	1	OF 514-01 B
	2	OF 514-02 B
	3	OF 514-03 B
	4	OF 514-04 B
	5	OF 514-05 B



180 mm / 7"	1	OF 519-01 B
	2	OF 519-02 B
	3	OF 519-03 B
	4	OF 519-04 B
	5	OF 519-05 B
200 mm / 8"	1	OF 520-01 B
	2	OF 520-02 B
	3	OF 520-03 B
	4	OF 520-04 B
	5	OF 520-05 B
230 mm / 9"	1	OF 521-01 B
	2	OF 521-02 B
	3	OF 521-03 B
	4	OF 521-04 B
	5	OF 521-05 B

oben schneidend
 up cutting

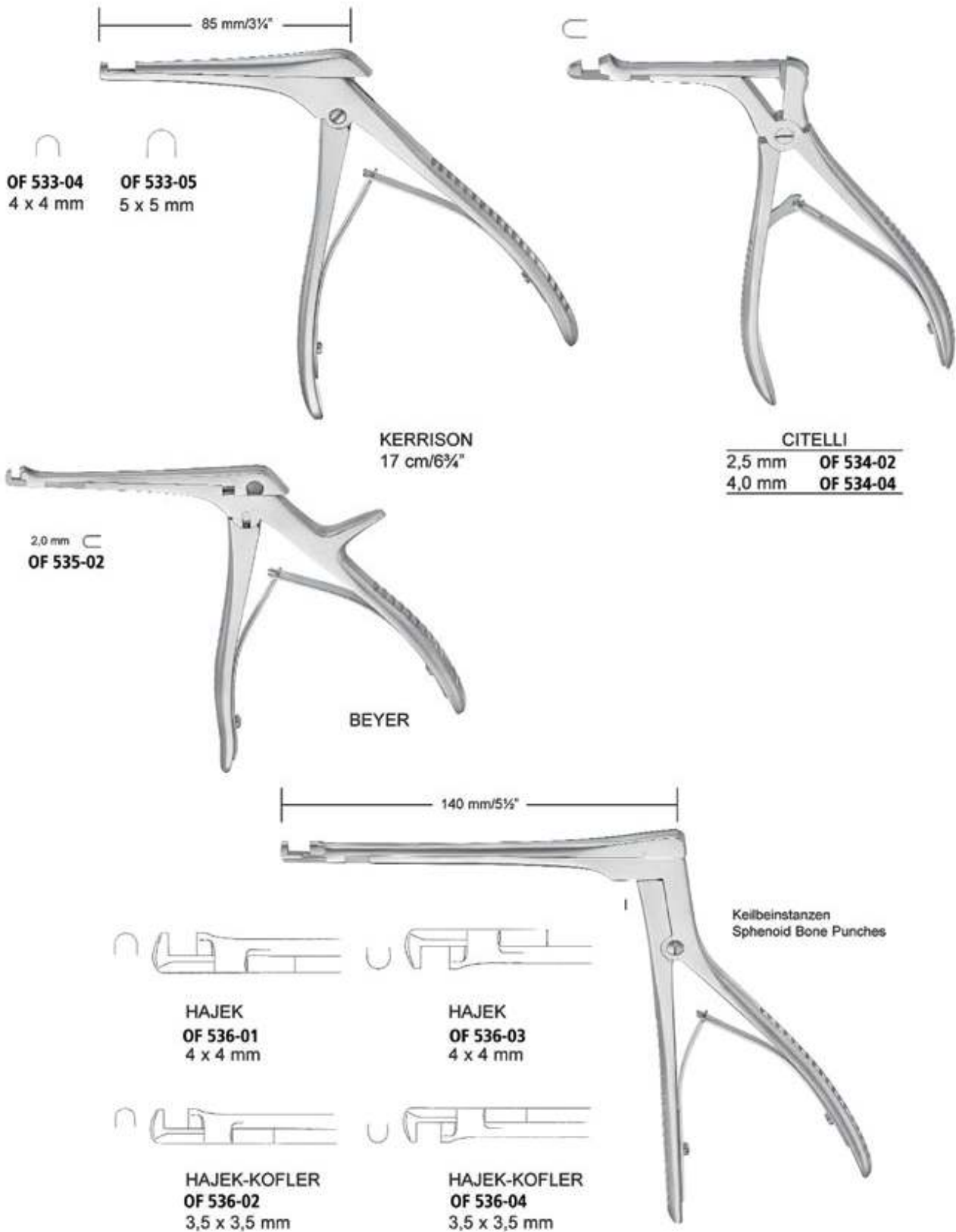



OF 920-00

BUNNEL
OF 900-16
16 cm



OF 920-00
1/4

OF 910-16



OF 910-26



OF 920-00



1/2
OF 912-01
 Ø 2,5 mm
 Fig. 1



OF 912-02
 Ø 3,0 mm
 Fig. 2



OF 912-03
 Ø 3,5 mm
 Fig. 3



OF 912-04
 Ø 4,0 mm
 Fig. 4



OF 912-05
 Ø 5,0 mm
 Fig. 6



OF 912-06
 Ø 8,0 mm
 Fig. 7



OF 912-07
 Ø 12 mm
 Fig. 8



OF 912-08
 Ø 16 mm
 Fig. 9

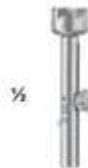

1/2
OF 912-09
 Ø 10 mm
 Fig. 5



OF 912-10
 Ø 1,0 mm
 Fig. 10



OF 912-11
 Ø 1,5 mm
 Fig. 11



OF 912-12
 Ø 2,0 mm
 Fig. 12

Tel Testereler
Wire Saws
Drahtsägen

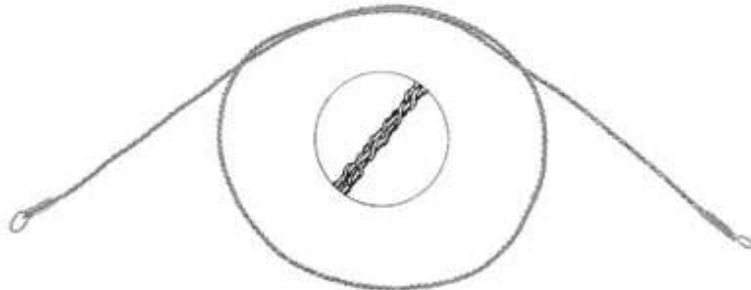

GIGLI
OF 940-30 30 cm
OF 940-40 40 cm
OF 940-50 50 cm
2 Telli/ With 2 wires



GIGLI
OF 665-00
Sap / Handle



Einführinstrument
Wire Saw Guide

De MARTEL
OF 945-33
33 cm/13"



LEBSCHKE
OF 946-25
25 cm/10"

Raspalar
Raspatories
Raspatorien



HALLE
KB 350-18
16 cm/6¼"
3,5 mm



½
FREER
KB 350-19
19 cm/7½"



½
FREER
KB 351-19
19 cm/7½"

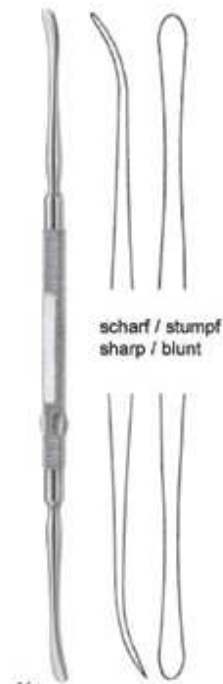

½
FREER
KB 353-18
18,5 cm/7¼"

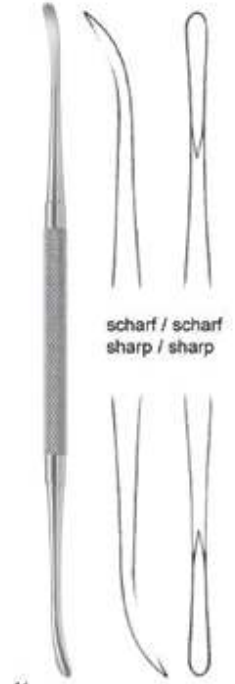

½
FREER YASARGIL
KB 354-18
18,5 cm/7¼"



½
HOWARTH
KB 356-22
22 cm/8¾"

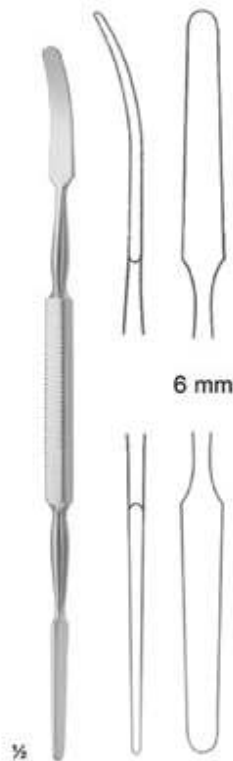

½
McDONALD
KB 357-19
19 cm/7½"

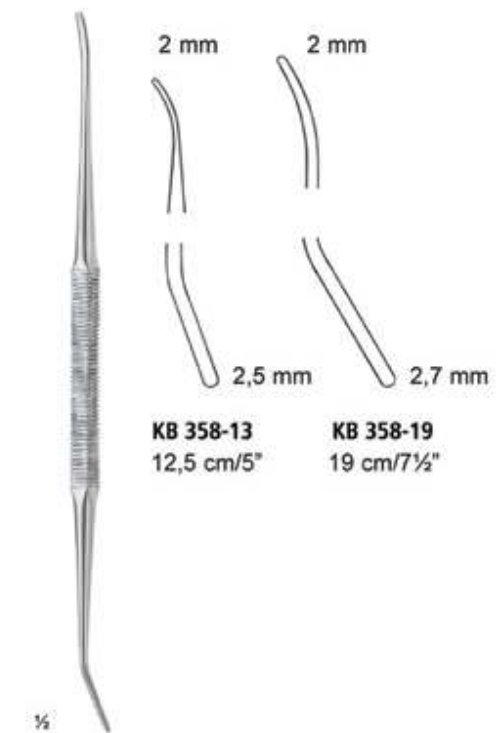

½
WATSON CHEYNE

KB 358-13
12,5 cm/5"

KB 358-19
19 cm/7½"

Raspalar
Raspatories
Raspatorien

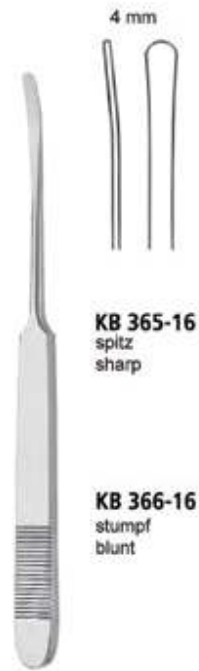

ST CLAIR THOMPSON
 16 cm/6 1/4"



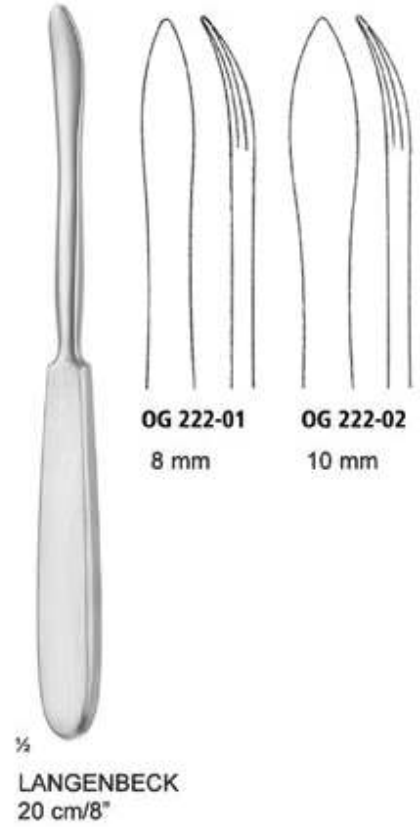
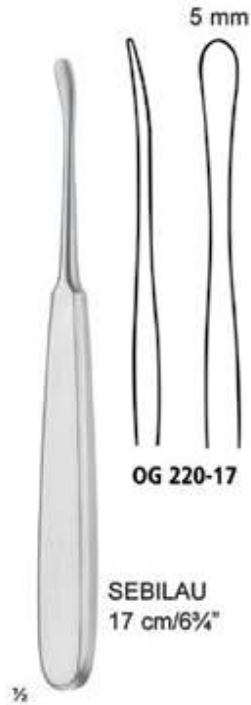

Spinal-Fusionsküretten
Spinal Fusion Curettes



BRUNS
23 cm/9"

Kemik Küretleri
Bone Curettes
Scharfe Löffel

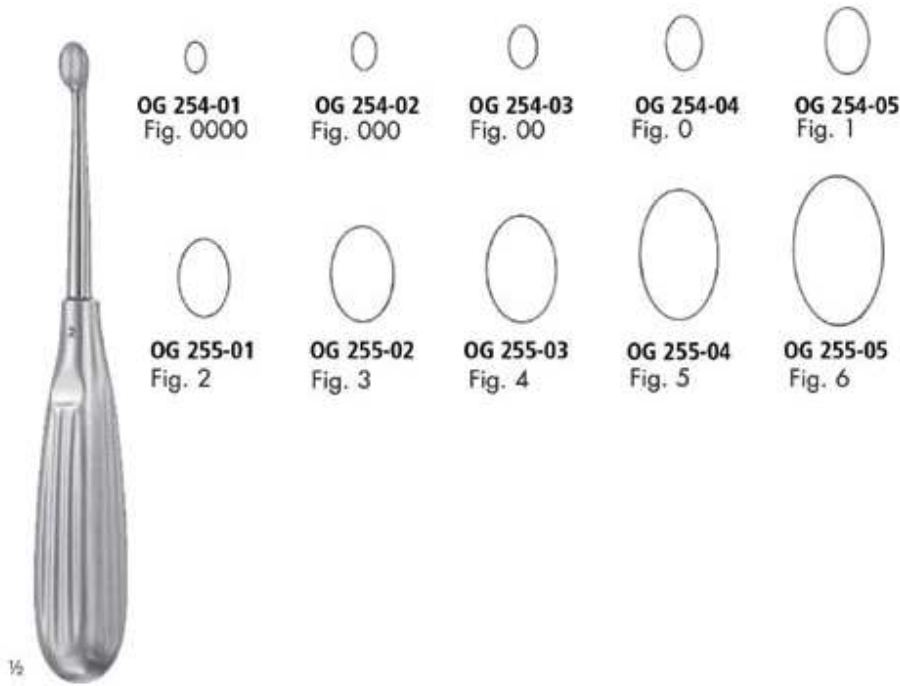

OG 254-01
 Fig. 0000

OG 254-02
 Fig. 000

OG 254-03
 Fig. 00

OG 254-04
 Fig. 0

OG 254-05
 Fig. 1

OG 255-01
 Fig. 2

OG 255-02
 Fig. 3

OG 255-03
 Fig. 4

OG 255-04
 Fig. 5

OG 255-05
 Fig. 6

VOLKMANN
 17 cm/6¾"



OG 258-01
 Fig. 1

OG 258-02
 Fig. 2

OG 258-03
 Fig. 3

HALLE
 21 cm/8½"

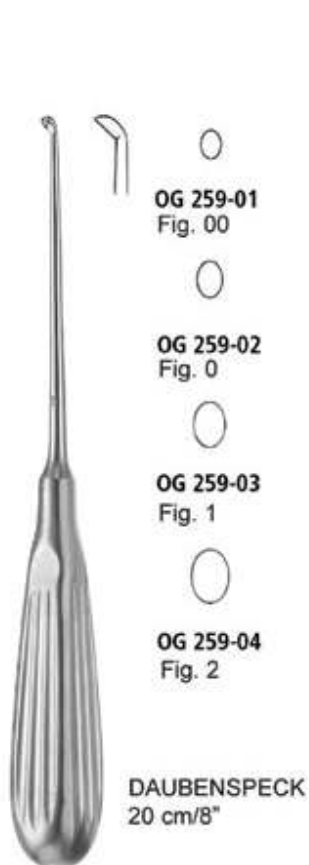

OG 259-01
 Fig. 00

OG 259-02
 Fig. 0

OG 259-03
 Fig. 1

OG 259-04
 Fig. 2

DAUBENSPECK
 20 cm/8"



OG 260-01
 3,6 mm

OG 261-01
 3,6 mm

OG 260-02
 4,4 mm

OG 261-02
 4,4 mm

OG 260-03
 5,2 mm

OG 261-03
 5,2 mm

OG 260-04
 6,8 mm

OG 261-04
 6,8 mm

25 cm/9¾"



OG 262-01
 3,0 mm

OG 262-02
 4,0 mm

OG 262-03
 5,0 mm

BUSHE
 25 cm/10"

Kemik Küretleri
Bone Curettes
Scharfe Löffel

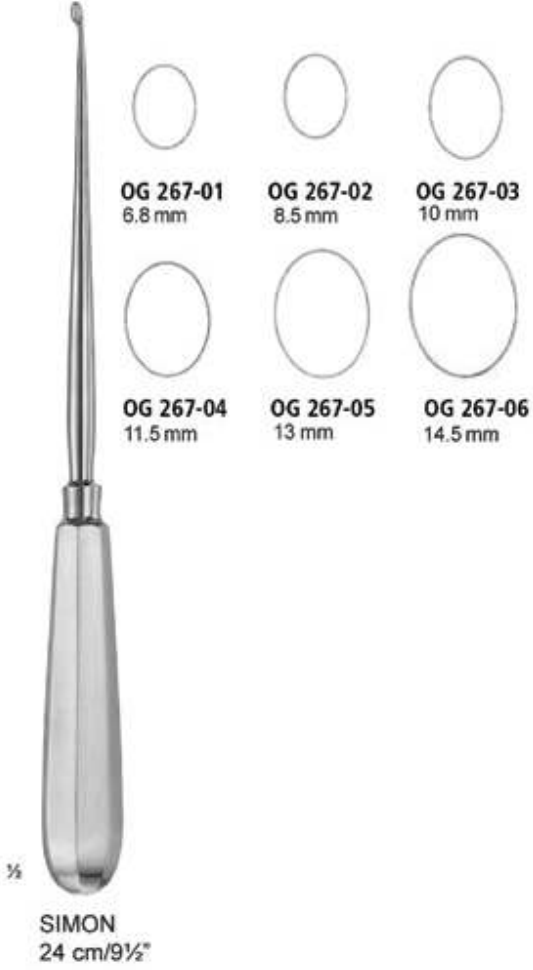



WILLIGER
OG 277-01
 13 cm/5"



WILLIGER
OG 277-02
 16 cm/6 1/4"



JANSEN
OG 277-16
 16,5 cm/6 1/2"

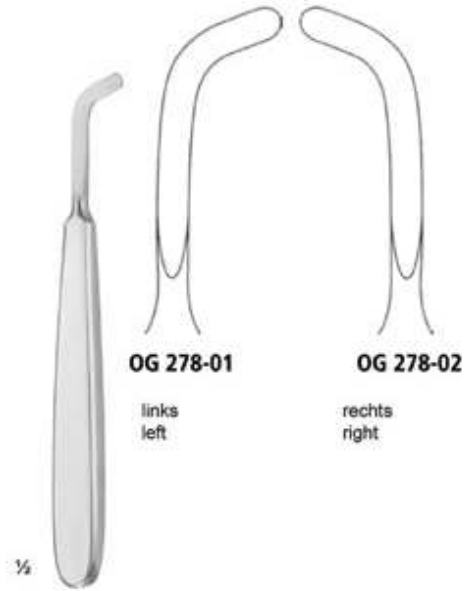

14 cm/5 1/2"

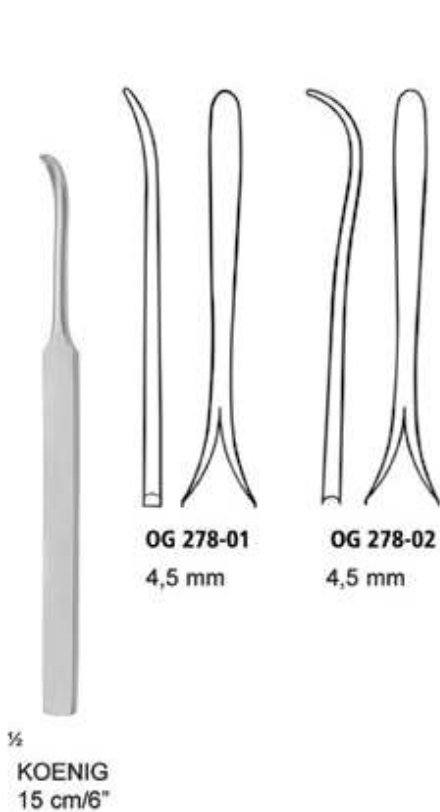

KOENIG
 15 cm/6"

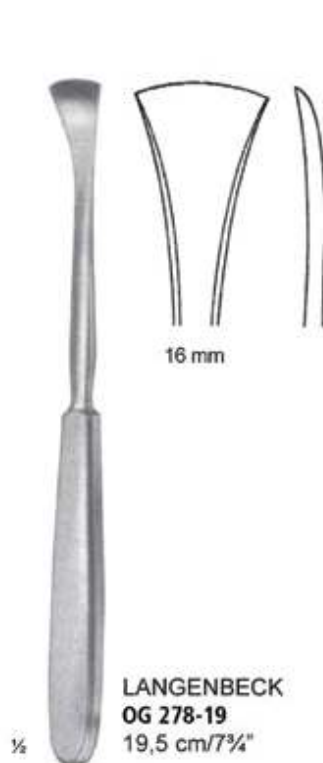

LANGENBECK
OG 278-19
 19,5 cm/7 3/4"



JOSEPH
OG 279-17
 16 cm/6 1/4"

Elevatorler Disektorler
Elavators Dissectors
Elevatorien Dissektoren

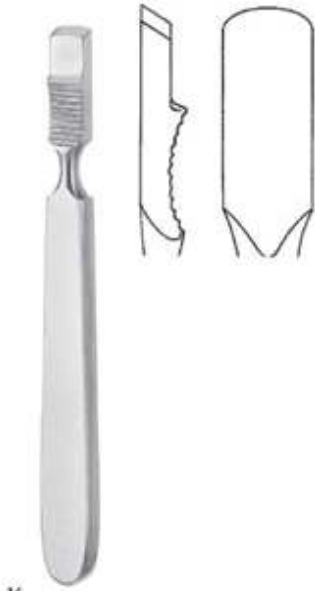

1/2
FARABEUF
OG 280-14
 15 cm/5 3/4"

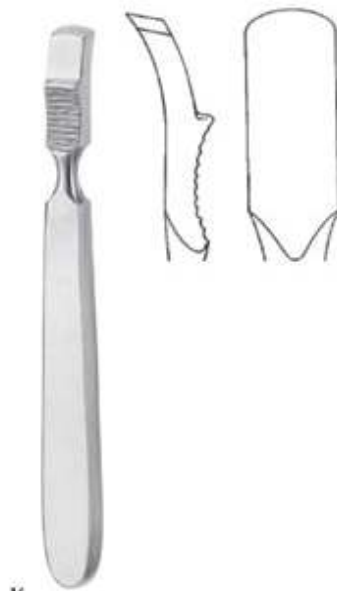

1/2
FARABEUF
OG 281-14
 15 cm/5 3/4"



1/2
FARABEUF - COLLIN
 16 cm/6 1/4"



1/2
FARABEUF - COLLIN
 16 cm/6 1/4"



1/2
SEDILLOT
OG 284-18
 18,5 cm/7"

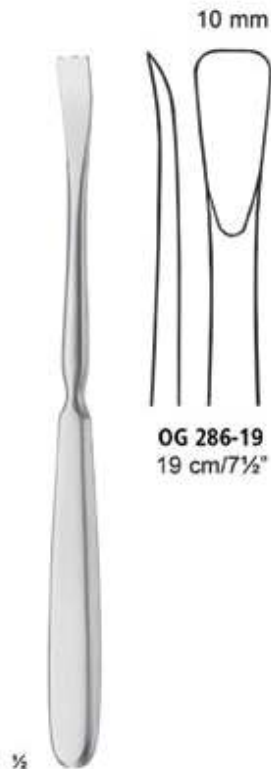

1/2
KRÄMER



1/2
OG 286-18
 18,5 cm/7 1/4"



1/2
SEDILLOT
OG 287-21
 21 cm/8 1/4"

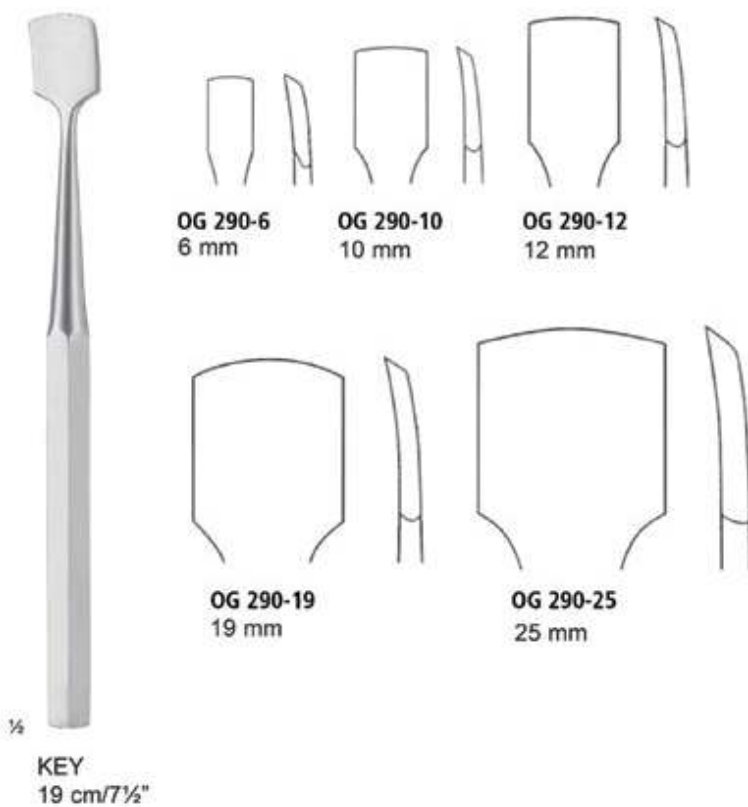
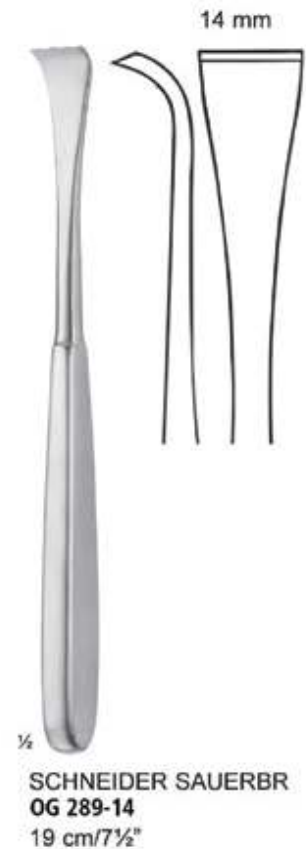
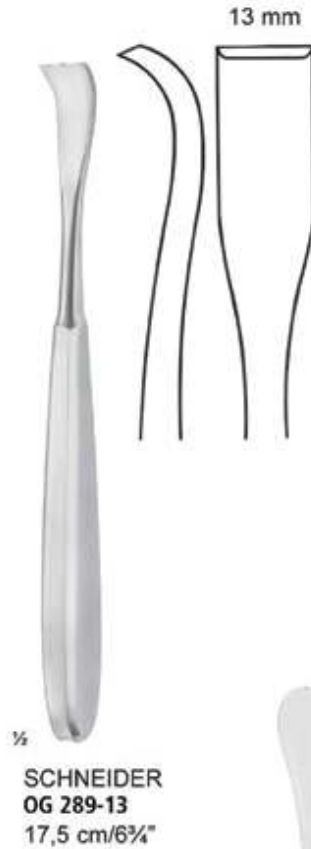
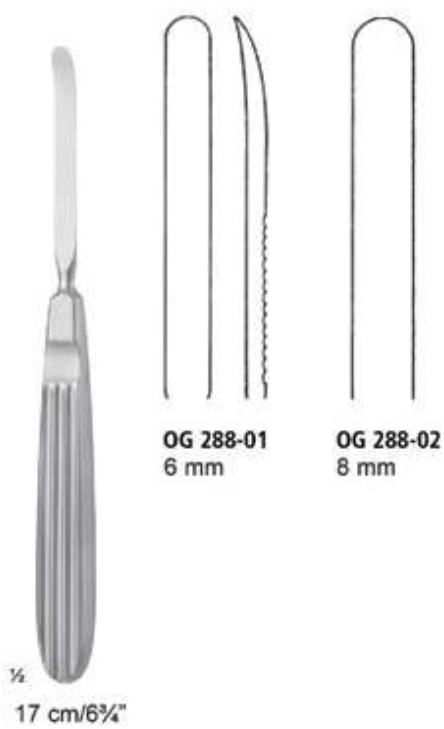

Raspalar
Raspatories
Raspatorien

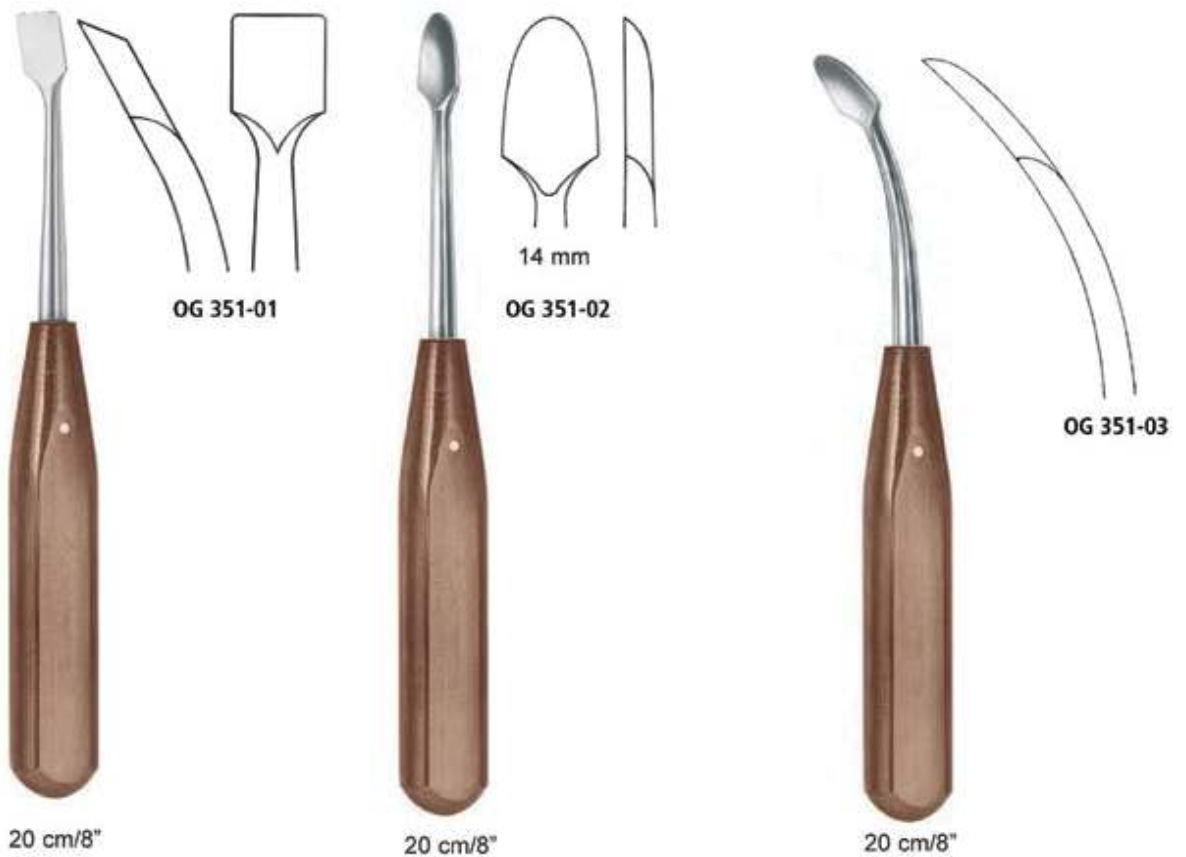
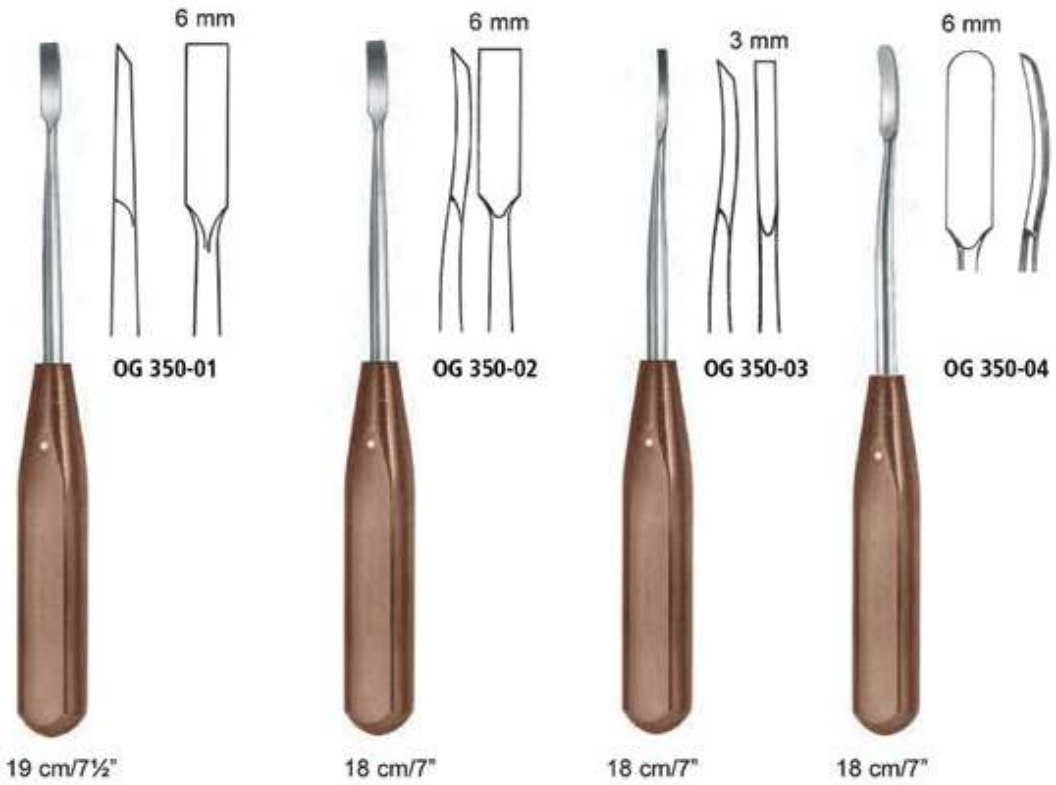



1/2

CASPAR
20 cm/8"

OG 354-01
ø 3 mm

OG 354-02
ø 5 mm

OG 354-03
ø 8 mm



1/2

20 cm/8"

OG 355-01
ø 12 mm

OG 355-02
ø 14 mm

OG 355-03
ø 16 mm



1/2

OG 358-01
ø 3 x 8 mm

OG 358-02
ø 4 x 10 mm

OG 358-03
ø 5 x 15 mm

OG 358-04
ø 6 x 20 mm

29 cm/11 1/2"

Elevatorler Disektorler
Elavators Dissectors
Elevatorien Dissektoren

Dura-Elevatoren
 Dura separators

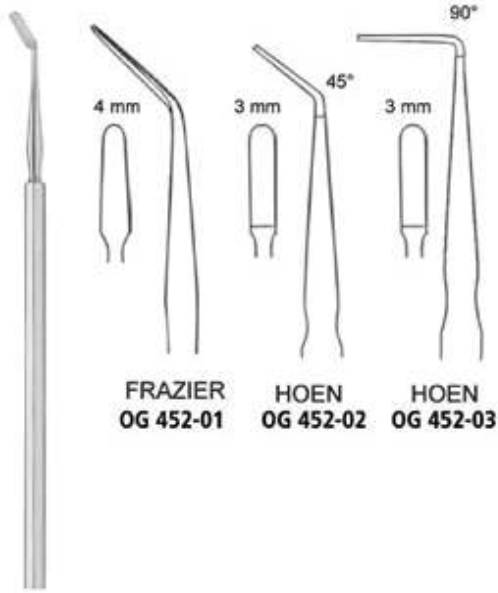

FRAZIER
OG 452-01

HOEN
OG 452-02

HOEN
OG 452-03

15 cm/6"



$\frac{1}{8}$
ADSON
 17 cm/6 $\frac{3}{4}$ "



8 mm
OG 463-01



7 mm
OG 463-02



7 mm
OG 463-03



7 mm
OG 463-04

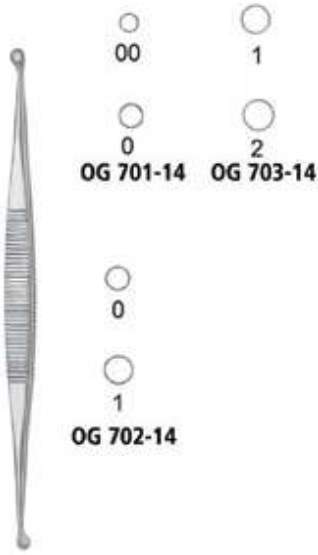

OG 701-14 **OG 703-14**

OG 702-14

$\frac{1}{8}$
MARTINI
 13,5 cm/5 $\frac{1}{4}$ "



$\frac{1}{8}$
OG 706-21
 21 cm/8 $\frac{1}{4}$ "



$\frac{1}{8}$
VOLKMANN

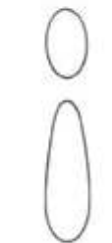

OG 710-13
 13 cm/5"

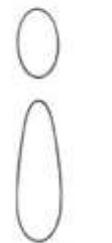

OG 711-14
 14 cm/5 $\frac{1}{2}$ "



OG 712-17
 17 cm/6 $\frac{3}{4}$ "

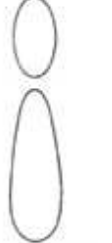

32.494.20
 20 cm/8"

Kemik Ronjurları
Bone Ronguers
Hohlmeißelzangen



komplett mit je 1 kleinen und 1 großen Blatt
complete with 1 small and 1 large blade

DeVILBISS
OM 150-21
21 cm/8¼"



komplett mit 2 Reserveblättern
complete with 2 spare blades

DAHLGREN
OM 151-21
21 cm/8¼"



CONE

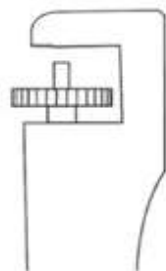

OM 152-01
20 cm/8"

bis 7 mm Schädelstärke
for skull thickness up to 7 mm

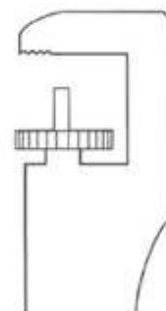

OM 152-02
23 cm/9"

bis 12 mm Schädelstärke
for skull thickness up to 12 mm



OM 153-20
20,5 cm/8"

Bohrloch-Schutzzange
Bore hole protection forceps

Kemik Ronjurları
Bone Ronguers
Hohlmeißelzangen

iDOL
CERRAHİ ALETLER
www.idolcerrahi.com



für die erste Rippe
for the first rib

SAUERBUCH-FREY
OM 200-37
36 cm/14"

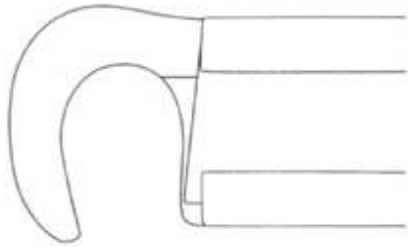

½

SAUERBUCH
OM 202-26
26 cm/10¼"

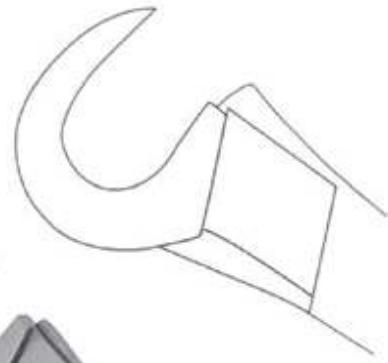

½

GIERTZ-STILLE
OM 202-27
27 cm/10½"

Kemik Ronjurları
Bone Ronguers
Hohlmeißelzangen

iDOL
CERRAHİ ALETLER
www.idolcerahi.com



½

SEMB



OM 214-24
22,5 cm/9"

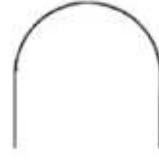

OM 215-31

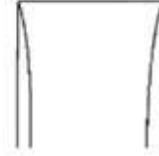

OM 216-31

Kemik Ronjurları
Bone Ronguers
Hohlmeißelzangen

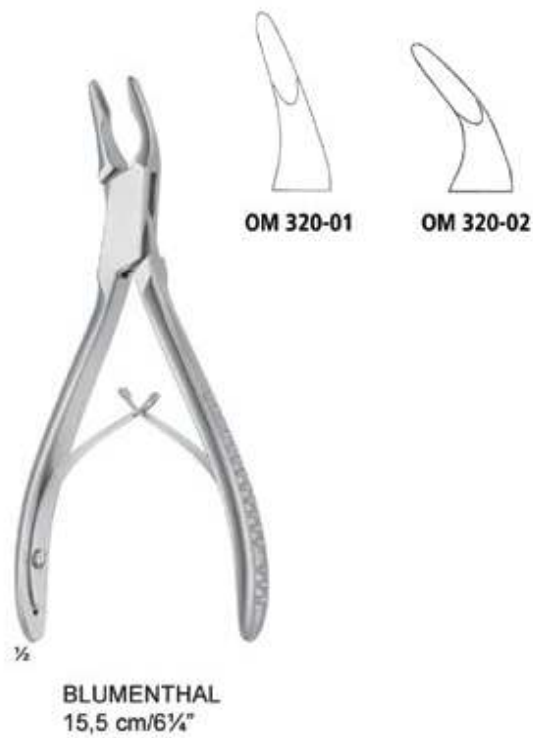
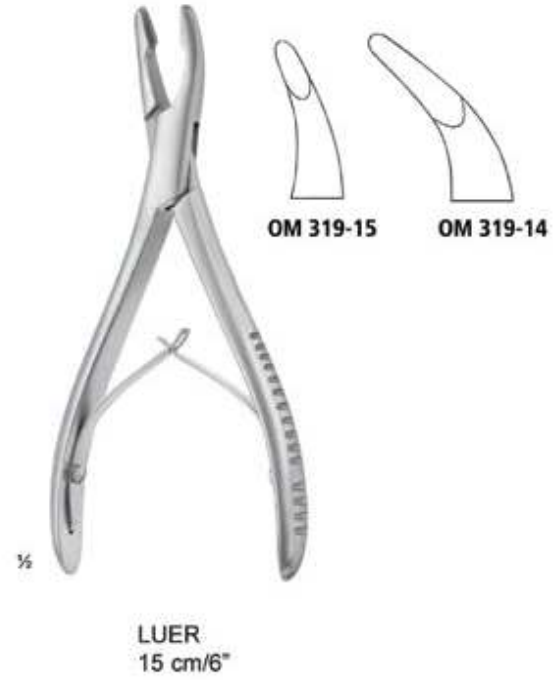
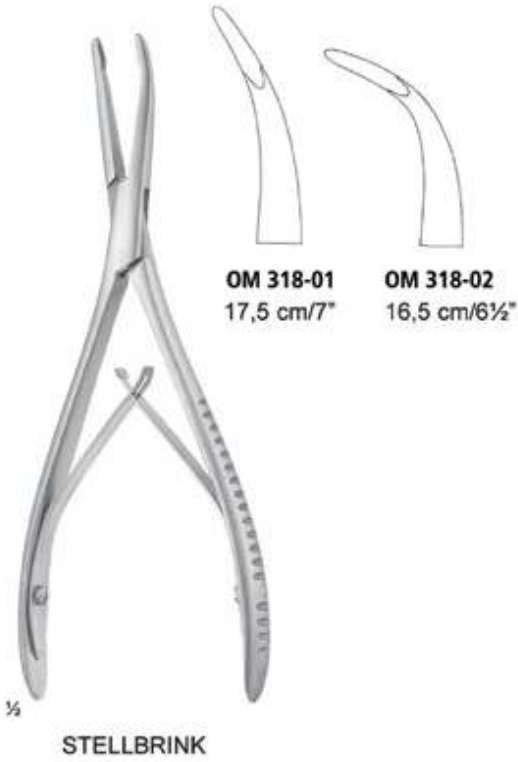



½
JANSEN
OM 329-19
19 cm/7½"



OM 330-20 **OM 331-21**

Synovektomie-zangen
Synovectomy Rongeurs

½
LEMPERT
18,5 cm/7¼"



½
BEYER
OM 332-18
18 cm/7"



½
MEAD
OM 333-16
16 cm/6¼"



½
MEAD
OM 333-17
16,5 cm/6½"

Kemik Ronjurları
Bone Ronguers
Hohlmeißelzangen

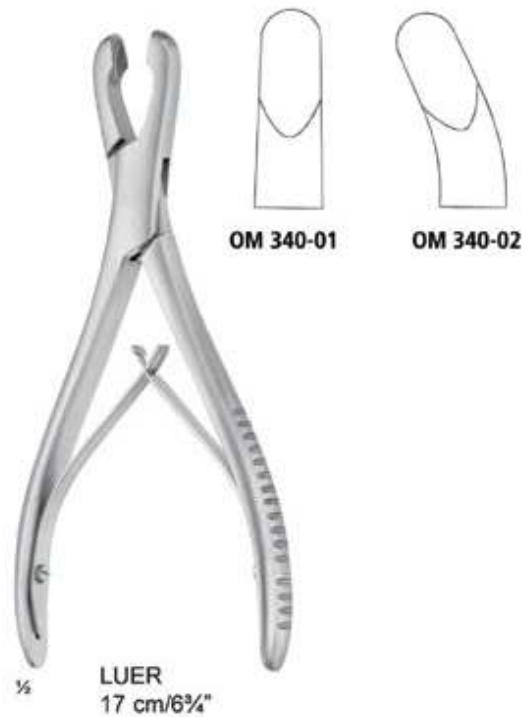



½
MAYFIELD
OM 340-17
17 cm/6¾"



½
MARQUARDT
OM 340-20
20 cm/8"



½
OLIVECRONA
OM 344-20
20 cm/8"



½
GULEKE
OM 345-20
20,5 cm/8¼"



seitwärts abgewinkelt
angled to side

½
TROTTER
OM 346-20
20,5 cm/8"

Kemik Ronjurları
Bone Ronguers
Hohlmeißelzangen





STILLE LUER
OM 353-23
23 cm/9"



STILLE RUSKIN
OM 355-24
23 cm/9"

Kemik Ronjurları
Bone Ronguers
Hohlmeißelzangen

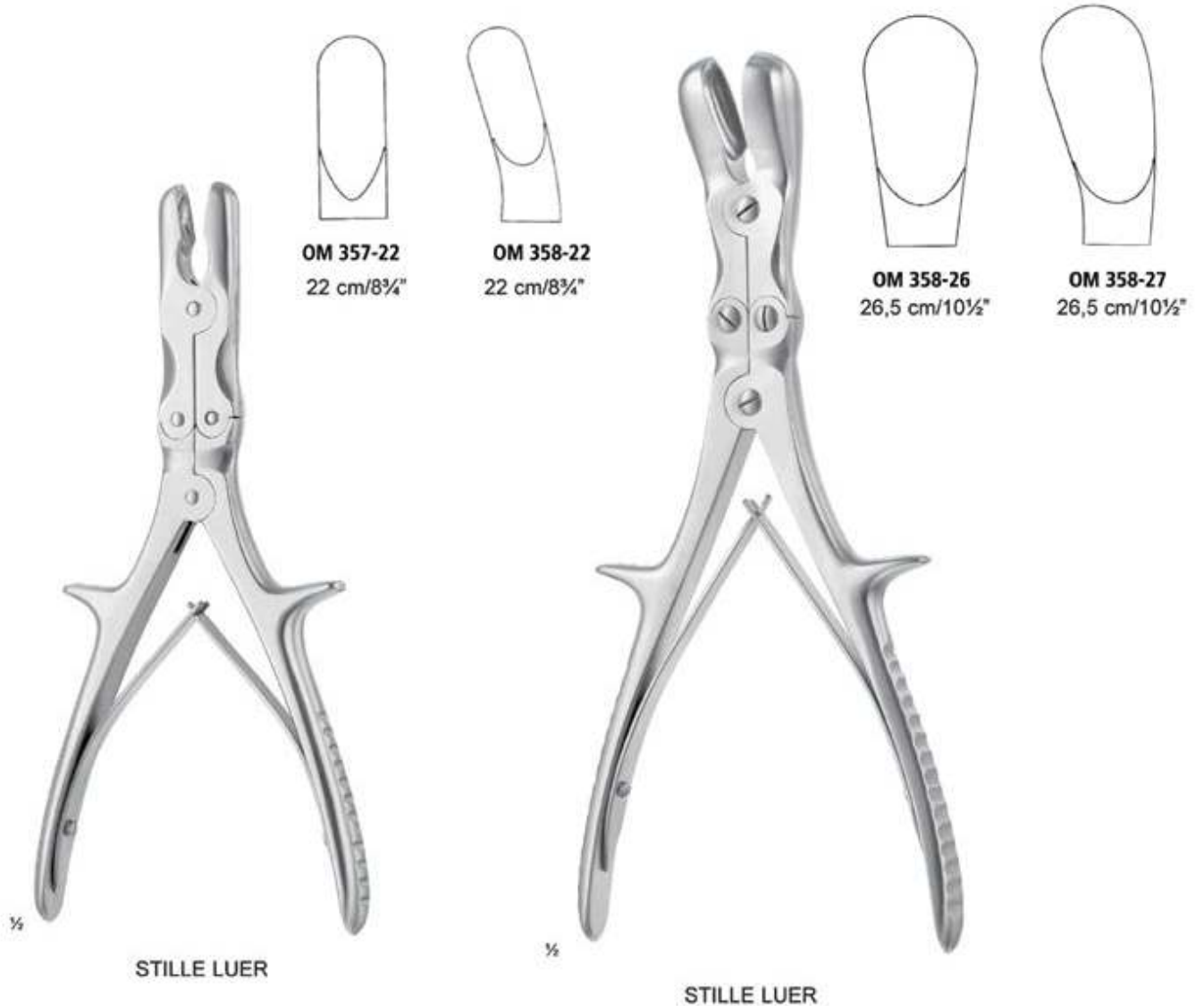



$\frac{1}{2}$
RUSKIN LISTON
18,5 cm/7 $\frac{1}{4}$ "

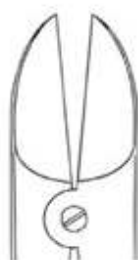

OM 362-19



OM 363-19



$\frac{1}{2}$
McINDOE
OM 363-17
19 cm/7 $\frac{1}{2}$ "



$\frac{1}{2}$
STILLE HORSLEY
OM 369-25
27 cm/10 $\frac{1}{2}$ "

Mikro Portegüler
Micro Needle Holders
Mikro-Nadelhalter





ohne Sperre
without catch



15 cm/6"	PO 108-15	PO 109-15
18,5 cm/7¼"	PO 115-18	PO 116-18



mit Sperre
with catch



15 cm/6"	PO 110-15	PO 111-15
18,5 cm/7¼"	PO 117-18	PO 118-18

Mikro Portegüler
Micro Needle Holders
Mikro-Nadelhalter





PO 131-16
16 cm/6¼"

PO 132-16
16 cm/6¼"

PO 131-18
18,5 cm/7¼"

PO 132-18
18,5 cm/7¼"

ohne Sperre
without catch



PO 135-18
mit Sperre
with catch

JACOBSON
18 cm/7"

Mikro Portegüler
Micro Needle Holders
Mikro-Nadelhalter



YASARGIL



PO 136-20
20 cm/8"



PO 136-22
22,5 cm/9"



PO 137-16
16,5 cm/6½"



PO 137-20
20 cm/8"



PO 137-22
22,5 cm/9"



CRILE WOOD
15 cm/6" PO 219-15
18 cm/7" PO 219-18
20 cm/8" PO 219-20

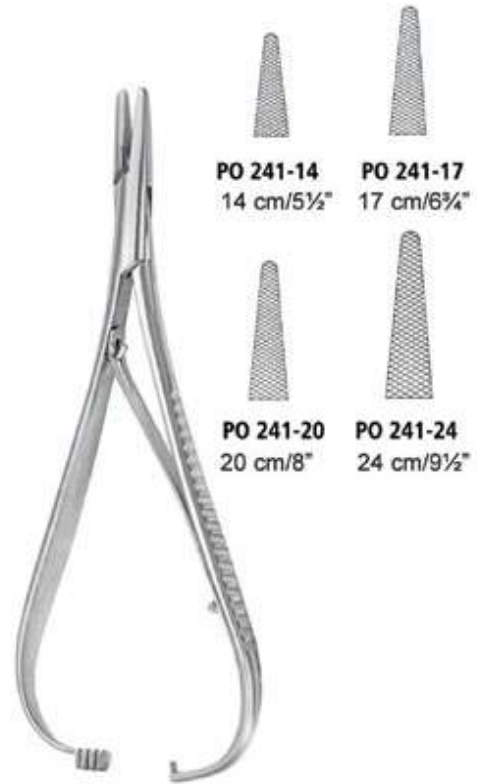







PO 241-14 14 cm/5½"
PO 241-17 17 cm/6¾"
PO 241-20 20 cm/8"
PO 241-24 24 cm/9½"







MATHIEU

Portegüler
Needle Holders
Nadelhalter









			
PO 900-14 14 cm/5½"	PO 900-16 16 cm/6¼"	PO 900-18 18 cm/7"	PO 900-20 20 cm/8"
			
PO 900-24 24 cm/9½"	PO 900-26 26 cm/10¼"	PO 900-30 30 cm/12"	



			
PO 901-15 15 cm/6"	PO 901-18 18 cm/7"	PO 901-20 20 cm/8"	
			
PO 901-23 24 cm/9"	PO 901-26 26 cm/10¼"	PO 901-31 31 cm/12½"	









RYDER

- | | | |
|---|---|---|
| 
PO 902-13
13 cm/5" | 
PO 902-15
15 cm/6" | 
PO 902-18
18 cm/7" |
| 
PO 902-20
20 cm/8" | 
PO 902-23
23 cm/9" | 
PO 902-26
26 cm/10¼" |



RYDER VASCULAR

- | | | |
|---|---|---|
| 
PO 903-13
12,5 cm/5" | 
PO 903-15
15,5 cm/6" | 
PO 903-18
17,5 cm/7" |
| 
PO 903-20
20 cm/8" | 
PO 903-23
22,5 cm/9" | 
PO 903-26
26 cm/10¼" |





NEIVERT
13 cm/5½"



HALSEY
13 cm/5½"



BAUMGARTNER
14 cm/5½"

- | | |
|---|--|
| 
PO 915-13
glattes Maul
smooth jaw | 
PO 916-13 |
|---|--|



PO 916-14

**Portegüler
Needle Holders
Nadelhalter**

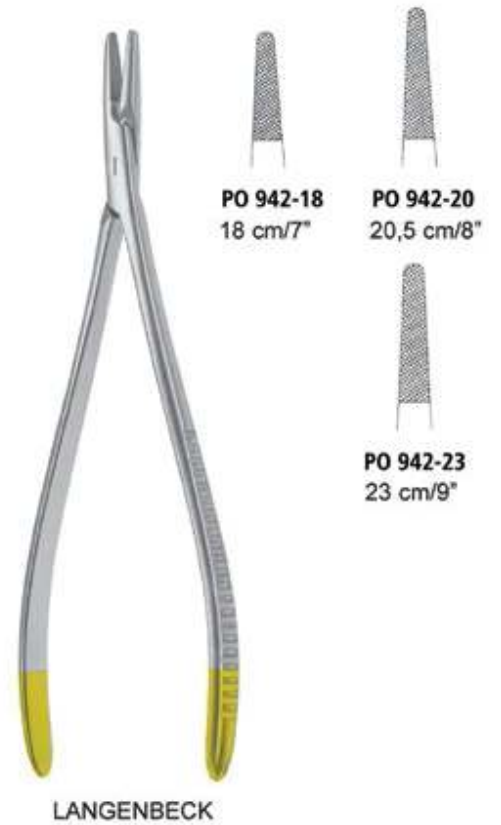



CASTROVIEJO-
 JACOBSON

	glattes Maul smooth jaw			
mit Sperre with catch				
			0,3	0,3
14,5 cm/5¾"	PO 950-14	PO 951-14	PO 952-14	PO 953-14
18 cm/7"	PO 954-18	PO 955-18	PO 956-18	PO 957-18
21 cm/8¼"	PO 958-01	PO 959-01	PO 958-02	PO 959-02

**Portegüler
Needle Holders
Nadelhalter**



TOLEDO

	glattes Maul smooth jaw			
mit Sperre with catch				
			0,3	0,3
14,5 cm/5¾"	PO 965-01	PO 965-02	PO 966-01	PO 966-02
18 cm/7"	PO 967-01	PO 967-02	PO 968-01	PO 968-02
21 cm/8¼"	PO 969-01	PO 969-02	PO 970-01	PO 970-02

Ergonomischer Griff
Ergonomic handle



mit Sperre
 with catch

ohne Sperre
 without catch



diamantiertes Maul
 diamond-coated jaw

11 x 0,8 mm

11 x 0,8 mm

11 x 0,8 mm

11 x 0,8 mm

14,5 cm/5¾"
 18 cm/7"
 21 cm/8¼"

PO 990-01
PO 992-01
PO 994-01

PO 990-02
PO 992-02
PO 994-02

PO 991-01
PO 993-01
PO 995-01

PO 991-02
PO 993-02
PO 995-02

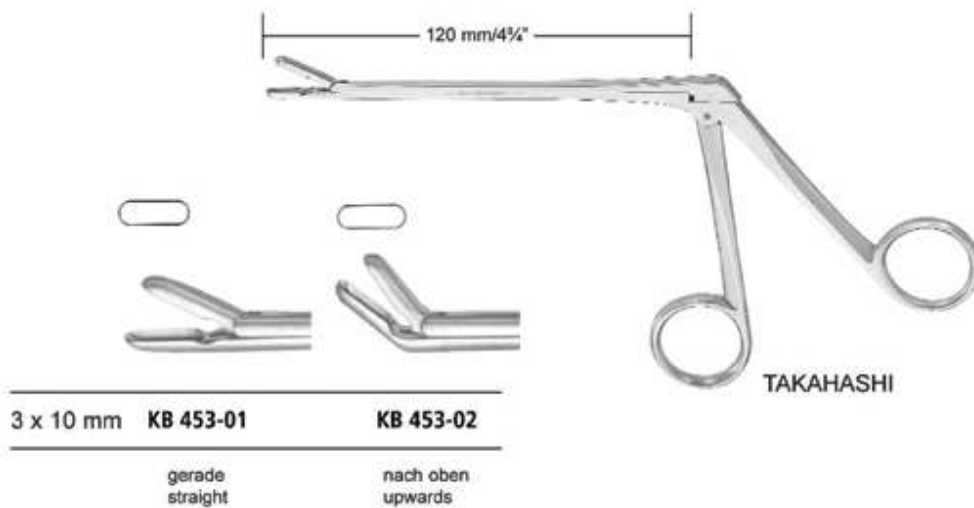
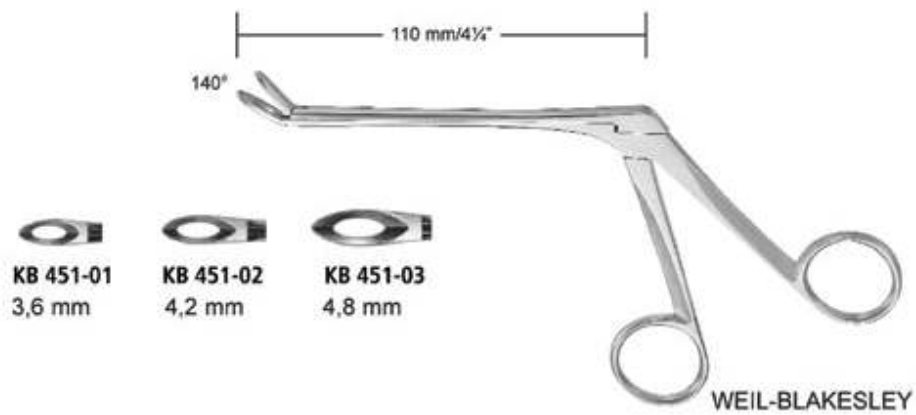
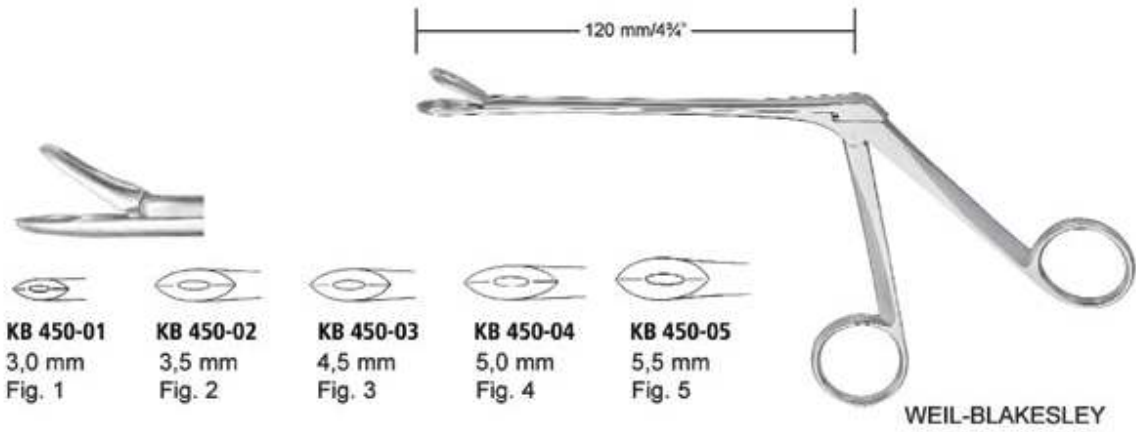

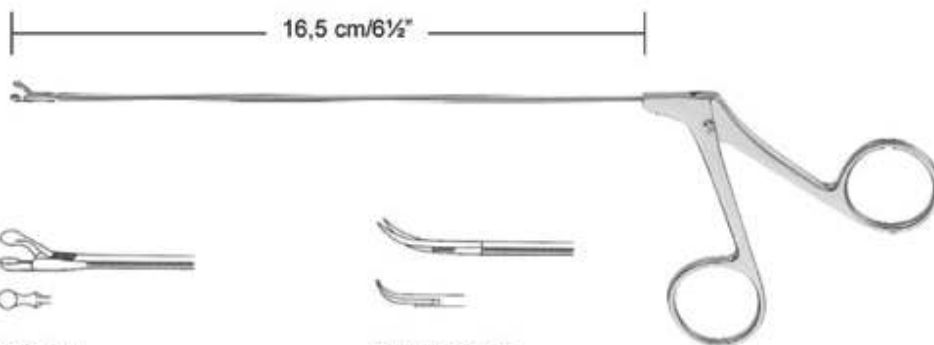

NICOLA
KB 641-00
Ø 2,5 mm

Scharfezange mit löffelförmigem Maul
Forceps, scoop-shaped

FAHLBUSCH
KB 641-01

Schere, horizontal schneidend
Schere, horizontal cutting, curved on flat



YASARGIL-NICOLA
KB 641-02

Faßzange mit feinem Maul
Forceps, long conical jaws

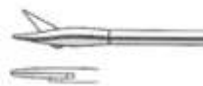

NICOLA
KB 641-03

Schere, gerade
Scissors, straight

Ronjurlar
Rongeurs
Rongeurs

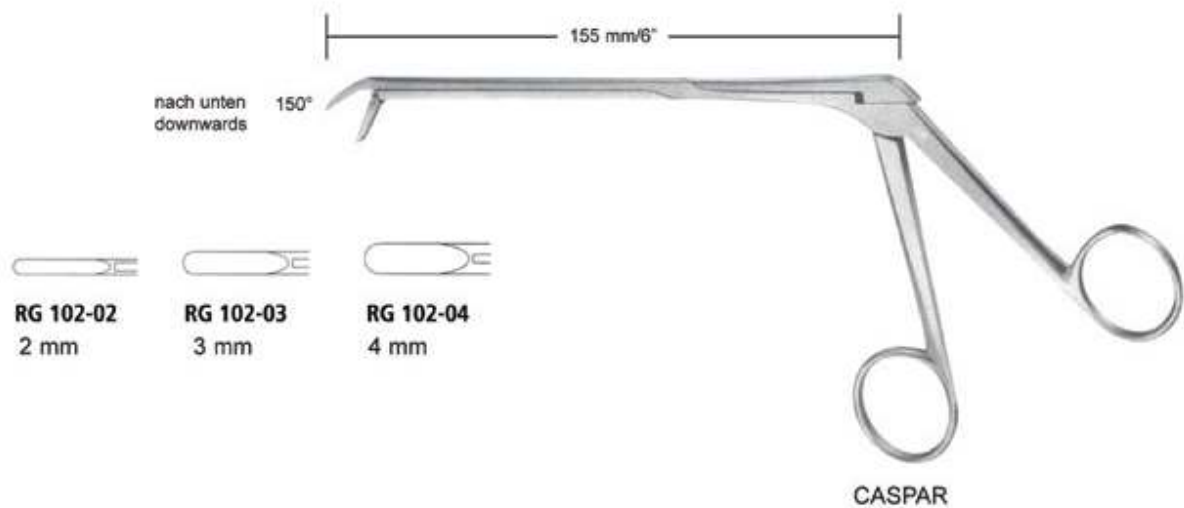
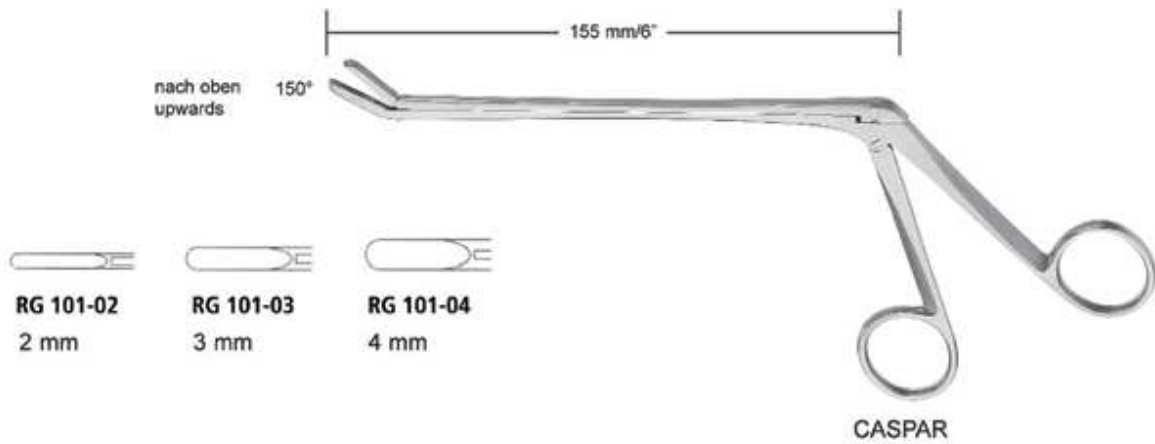
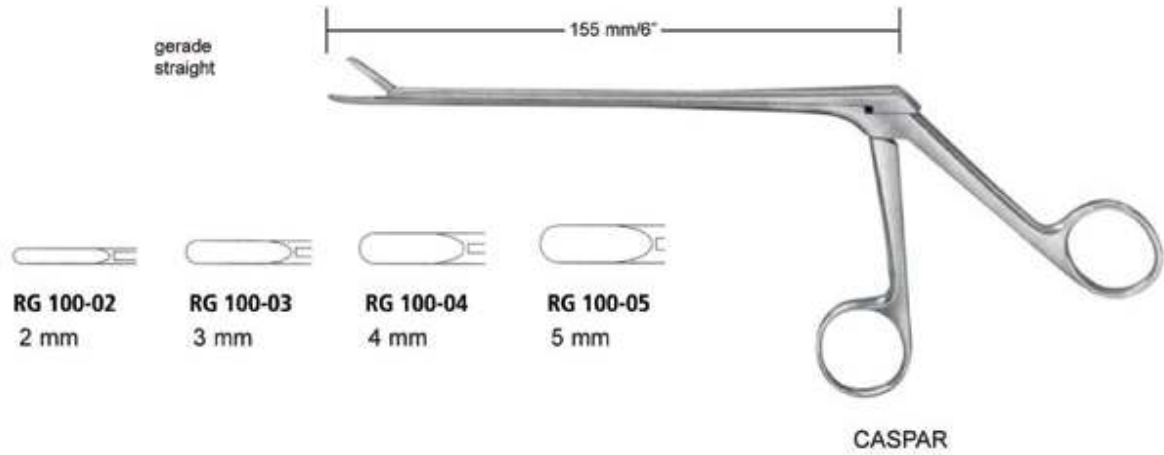

CASPAR

length of shaft	length of shaft	length of shaft	size of jaws
140 mm , 5 1/2"	160 mm , 6 1/4"	185 mm , 7 1/4"	
RG - 300 - 14	RG - 310 - 16	RG - 315 - 18	2 x 12 mm
RG - 301 - 14	RG - 311 - 16	RG - 316 - 18	3 x 12 mm
RG - 302 - 14	RG - 312 - 16	RG - 317 - 18	4 x 14 mm
	RG - 313 - 16	RG - 318 - 18	5 x 14 mm
	RG - 314 - 16	RG - 319 - 18	6 x 16 mm

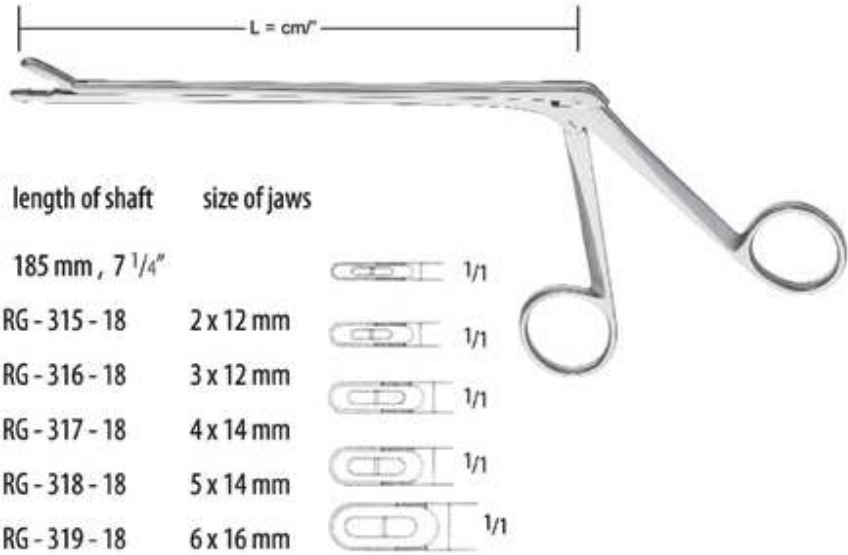

150°

CASPAR

length of shaft	length of shaft	length of shaft	size of jaws
140 mm , 5 1/2"	160 mm , 6 1/4"	185 mm , 7 1/4"	
RG - 330 - 14	RG - 335 - 16	RG - 340 - 18	3 x 12 mm
RG - 331 - 14	RG - 336 - 16	RG - 341 - 18	4 x 14 mm
	RG - 337 - 16	RG - 342 - 18	5 x 14 mm

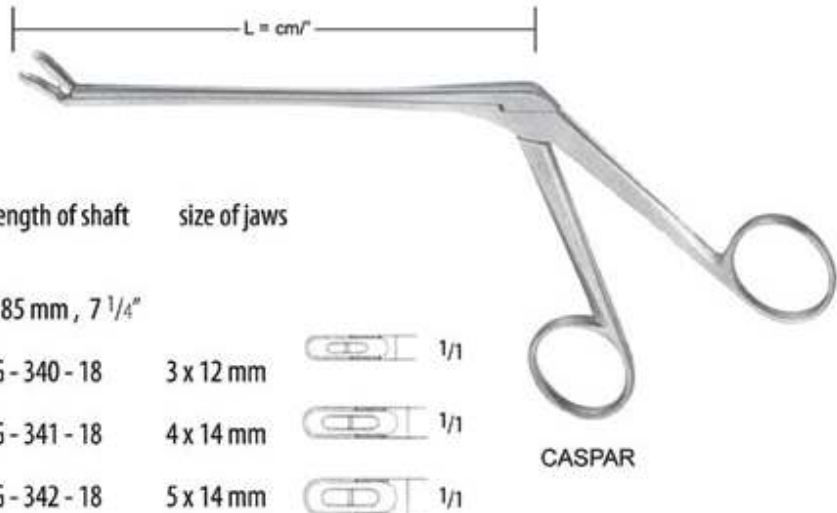

150°

CASPAR

length of shaft	length of shaft	length of shaft	size of jaws
140 mm , 5 1/2"	160 mm , 6 1/4"	185 mm , 7 1/4"	
RG - 350 - 14	RG - 355 - 16	RG - 360 - 18	3 x 12 mm
RG - 351 - 14	RG - 356 - 16	RG - 361 - 18	4 x 14 mm

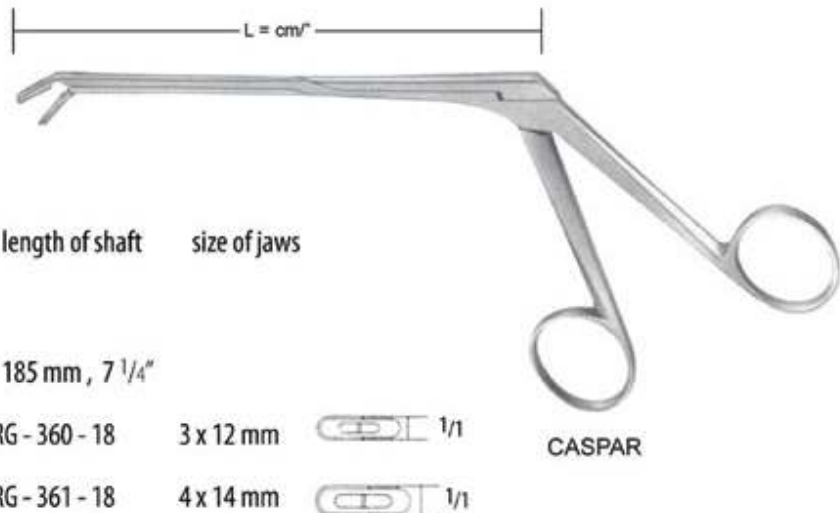

Ronjurlar
Rongeurs
Rongeurs

idOL
CERRAHİ ALETLER
www.idolcerahi.com

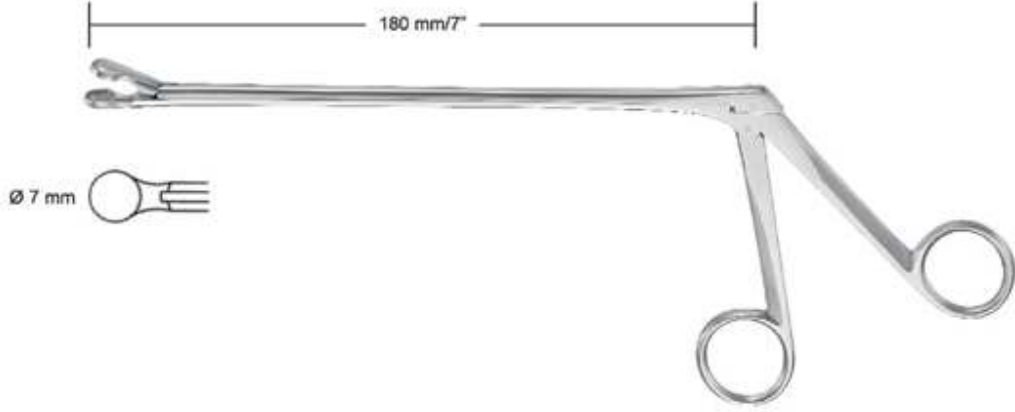

OLDBERG
RG 370-07
25 cm/10"

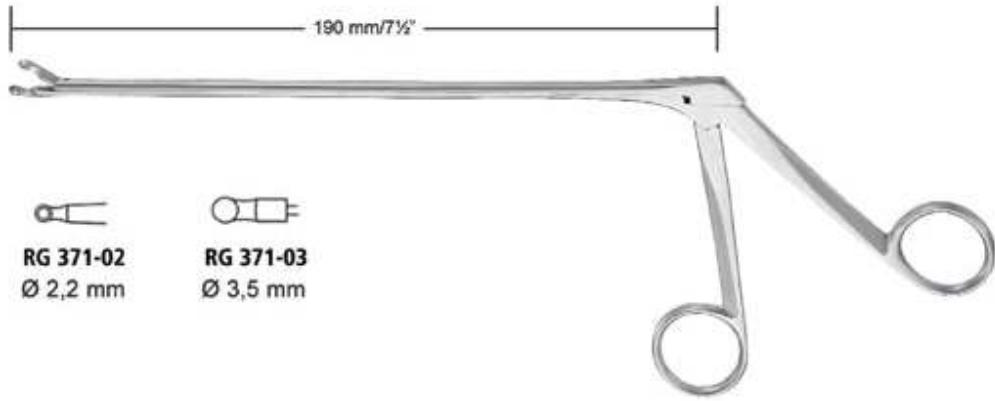

YASARGIL

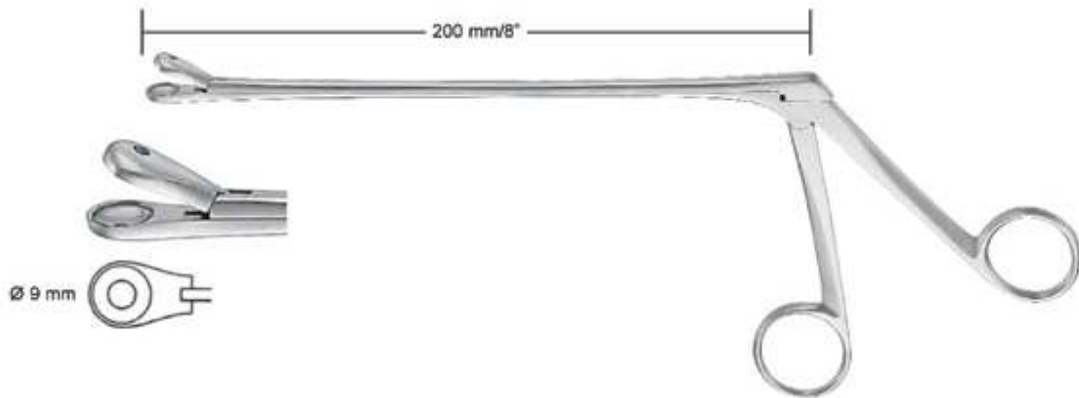

LANDOLT
RG 372-09

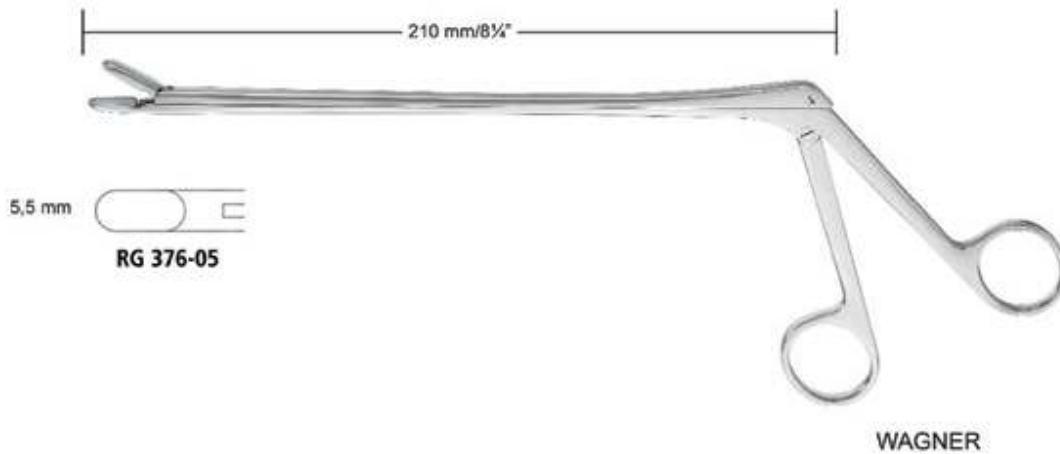
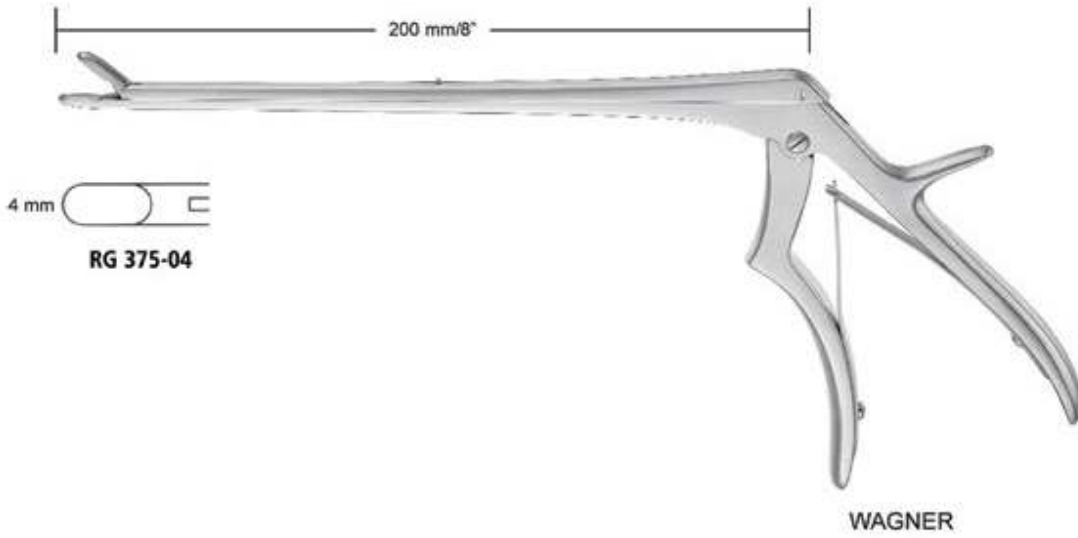

Galea Hukları
Galea Hooks
Galeahaken

idOL
CERRAHİ ALETLER
www.idolcerahi.com

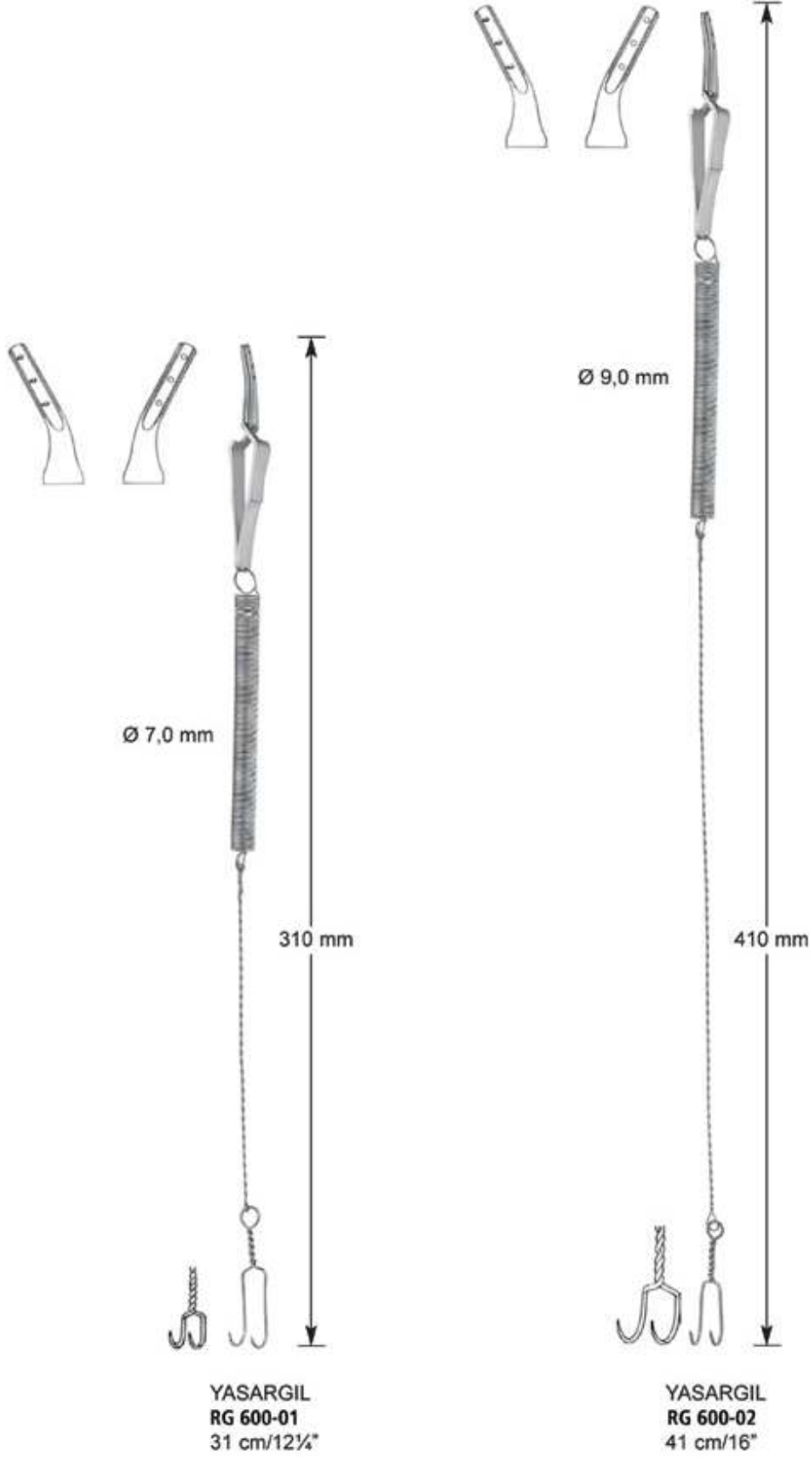



RG 605-01
 Handbohrapparate allein
 Hand Drill only

1/2

HUDSON
 27 cm/10 3/4"
RG 605-00



RG 610-09
 Ø 9 mm
 Fig. 1



RG 610-14
 Ø 14 mm
 Fig. 2



RG 610-16
 Ø 16 mm
 Fig. 3



RG 610-22
 Ø 22 mm
 Fig. 4



CUSHING
RG 611-14
 Ø 14 mm
 Fig. 5



RG 612-02
 Ø 2,0 mm
 Fig. 6



MCKENZIE
RG 610-13
 Fig. 7

Verlängerungsstück
 Extension piece



RG 605-02