

iDOL

CERRAHİ ALETLER  
SANAYİ VE TİCARET A.Ş.

OTOLOJİ - RİNOLOJİ - TONSİLEKTOMİ  
OTOLOGY - RHINOLOGY - TONSILLECTOMY  
OTOLOGIE - RHINOLIGIE - TONSILLEKTOMIE

RHINOLOGY  
RHINOLIGIE

RİNOLOJİ

TONSİLEKTOMİ

TONSILLECTOMY  
TONSILLEKTOMIE

OTOLOJİ

OTOLOGY  
OTOLOGIE



**Otoloji - Kulak mikro Cerrahi**  
**Otology**  
**Otologie**

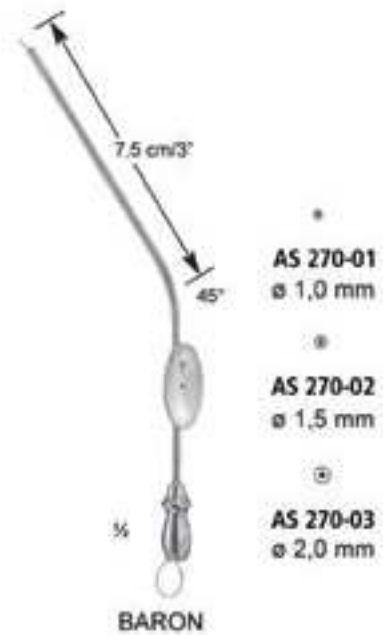



Mikro-Saugkanüle  
 Micro suction cannula



Saugadapter ø 7 mm  
 Suction adapter ø 7 mm





**BS 200-03**  
13,5 cm/5¼"  
Fig. 3  
solid, cm-graduation



**BS 200-04**  
13,5 cm/5¼"  
Fig. 4  
solid, cm-graduation



**BS 201-03**  
13,5 cm/5¼"  
Fig. 3



**BS 201-04**  
13,5 cm/5¼"  
Fig. 4



**BS 210-07**  
16 cm/6¼"  
Fig. 7



**BS 211-07**  
12,5 cm/5"  
Fig. 7 K



**BS 212-16**  
14,5 cm/5¾"  
Fig. 3 R



**BS 213-16**  
14 cm/5½"  
Fig. 3 R



**BS 230-16**  
16 cm/6¼"  
No. 5



**POLITZER  
BS 500-16**  
16,5 cm, 6½"  
Furuncle knife



**LUCAE  
BS 501-16**  
16 cm, 6¼"  
Tympanum perforator, for children



**LUCAE  
BS 501-18**  
18 cm, 7"  
Tympanum perforator, for adults



**LUCAE  
BS 501-19**  
18 cm, 7"  
Tympanum perforator, needle horizontally



**POLITZER  
BS 502-16**  
17 cm, 6¾"  
Tympanum perforator



**AGNEW (POLITZER)  
BS 503-17**  
17,5 cm, 7"  
Myringotome



**POLITZER  
BS 504-17**  
16/18 cm, 6¼ / 7"  
Tympanum perforator, reversible



**HARTMANN**  
**DP 100-01**  
c 128



**DP 100-02**  
c<sup>1</sup> 256



**DP 100-03**  
c<sup>2</sup> 512



**DP 100-04**  
c<sup>3</sup> 1024



**DP 100-05**  
c<sup>4</sup> 2048



**DP 100-06**  
c<sup>5</sup> 4096



**LUCAE**  
**DP 100-12**  
c 128



**DP 100-14**  
c<sup>1</sup> 256



**DP 100-15**  
c<sup>2</sup> 512



**DP 100-16**  
c<sup>3</sup> 1024



**DP 100-17**  
c<sup>4</sup> 2048



**DP 100-18**  
c<sup>5</sup> 4096





**DP 100-44**  
 a¹ 440



**DP 101-12** c 128  
**DP 101-25** c¹ 256  
**HARTMANN (FRENCH)**



**LUCAE**



**DP 102-12**  
 c 128



**RYDEL-SEIFFER**  
**DP 103-12**  
 C 64 / c 128



**DP 104-12** c 128



**BILLEAU**  
 16,5 cm, 6½"  
 Ear loops, straight

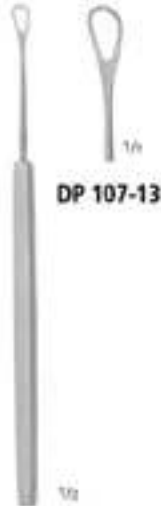

**LANGENBECK**  
 13 cm, 5¼"  
 Ear loop, curved



**SNELLEN**  
 16 cm, 6¼"  
 Ear loops, curved



**SHAPLEIGH**  
 16 cm, 6¼"  
 Ear loops, curved



Cerumen spoon and hook



Cerumen needle and cotton carrier

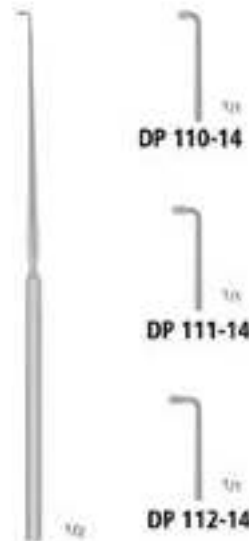

**LUCAE**  
 14 cm, 5½"  
 Ear hooks



**ZAUFAL**  
 16 cm, 6¼"  
 Ear lever

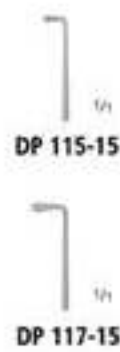

BUCK 17 cm, 6 3/4" Ear curettes	Outside diameter	1/2	1/2	1/2	1/2	1/2	1/2	1/2	1/2
	straight / sharp		<b>DP 129-01</b>	<b>DP 129-02</b>	<b>DP 129-03</b>	<b>DP 129-04</b>	<b>DP 129-05</b>	<b>DP 129-06</b>	<b>DP 129-07</b>
curved / sharp		<b>DP 130-01</b>	<b>DP 130-02</b>	<b>DP 130-03</b>	<b>DP 130-04</b>	<b>DP 130-05</b>	<b>DP 130-06</b>	<b>DP 130-07</b>	<b>DP 130-08</b>
straight / blunt		<b>DP 140-01</b>	<b>DP 140-02</b>	<b>DP 140-03</b>	<b>DP 140-04</b>	<b>DP 140-05</b>	<b>DP 140-06</b>	<b>DP 140-07</b>	<b>DP 140-08</b>
curved / blunt		<b>DP 141-01</b>	<b>DP 141-02</b>	<b>DP 141-03</b>	<b>DP 141-04</b>	<b>DP 141-05</b>	<b>DP 141-06</b>	<b>DP 141-07</b>	<b>DP 141-08</b>



**ALLPORT**  
**EK 424-95**  
 9,5 cm/3 $\frac{3}{4}$ "



**JANSEN**  
 10,5 cm/4 $\frac{1}{4}$ "



**JANSEN**  
 10 cm/4"



WEITLANER



**EK 435-10**

11,5 cm/4½"  
2 : 3  
sharp

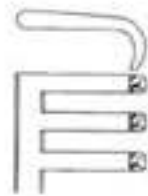

**EK 436-10**

11,5 cm/4½"  
2 : 3  
blunt



WEITLANER

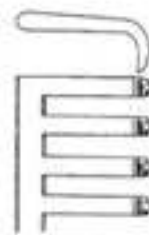

**EK 435-13**

13 cm/4¼"  
3 : 4  
sharp



**EK 436-13**

13 cm/4¼"  
3 : 4  
blunt

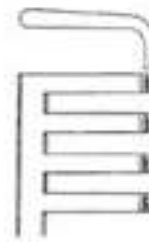

**EK 435-16**

16,5 cm 6½"  
3 : 4  
sharp



**EK 436-16**

16,5 cm 6½"  
3 : 4  
blunt



**MOLLISON**  
15 cm/6"



**EK 446-15**  
scharf  
sharp



**EK 447-15**  
stumpf  
blunt



**PLESTER**  
12 cm, 4 1/2"



**EK 475-13**  
2:2



**PLESTER**  
10.5 cm, 4 1/4"

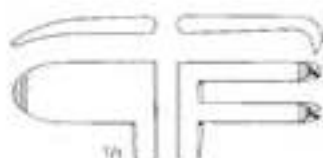

**EK 477-10**  
sharp



**PLESTER**  
10.5 cm, 4 1/4"



**EK 478-10**  
sharp



**ADSON**

12 cm/4 3/4"	<b>FO 200-12</b>
15 cm/6"	<b>FO 200-15</b>
18 cm/7"	<b>FO 200-18</b>



**ADSON micro**

12 cm/4 3/4"	<b>FO 201-12</b>
15 cm/6"	<b>FO 201-15</b>



**ADSON**

12 cm/4 3/4"	<b>FO 202-12</b>
15 cm/6"	<b>FO 202-15</b>
18 cm/7"	<b>FO 202-18</b>



**ADSON micro**

12 cm/4 3/4"	<b>FO 203-12</b>
15 cm/6"	<b>FO 203-15</b>



**FO 204-12**

Teeth in oblique position

**ADSON-BIEMER**  
 12 cm/4 3/4"



**FO 222-07**

**FO 222-09**

**ADSON-BROWN**  
 12 cm/4 3/4"



**McINDOE**  
 15 cm/6"

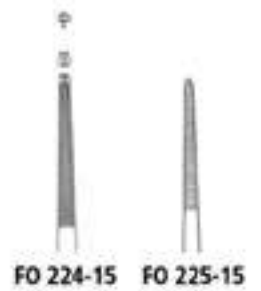

**FO 224-15**

**FO 225-15**





SEMKEN



FO 226-12  
12,5 cm/5"



FO 226-15  
15 cm/6"



FO 227-12  
12,5 cm/5"



FO 227-15  
15 cm/6"



SEMKEN

1:2



FO 228-12  
12,5 cm/5"

1:2



FO 228-15  
15 cm/6"

1:2



FO 229-12  
12,5 cm/5"

1:2



FO 229-15  
15 cm/6"



TAYLOR  
FO 230-17  
17 cm/6¾"



TAYLOR  
FO 232-17  
17 cm/6¾"

with dissector end



TAYLOR  
FO 233-17  
18,5 cm/7¼"

with dissector end



TAYLOR  
FO 242-17  
17 cm/6¾"

with dissector end



TAYLOR  
FO 243-17  
17 cm/6¾"

with dissector end





**FO 399-14**  
 14.5 cm



**FO 399-18**  
 18 cm



**FO 399-20**  
 20 cm



**POTTS-SMITH**

15,5 cm/6"	<b>FO 400-15</b>
18 cm/7"	<b>FO 400-18</b>
20 cm/8"	<b>FO 400-20</b>



**FO 403-15**  
 15,5 cm/6"  
 1:2  
 ↕ →



**GILLIES**



**ADSON**

12 cm/4 3/4"	<b>FO 405-12</b>
15 cm/6"	<b>FO 405-15</b>



**ADSON**

12 cm/4 3/4"	<b>FO 406-12</b>
15 cm/6"	<b>FO 406-15</b>



**McINDOE**

**FO 407-15**  
 15 cm/6"



**CUSHING**  
 17 cm/6 3/4"

**FO 407-17**



**FO 408-18**





LUCAE  
FO 703-14  
14 cm/5½"



JANSEN  
FO 705-16  
16 cm/6¼"



ADSON  
FO 705-18  
17,5 cm/7"



FO 705-14  
14 cm/5½"

12



FO 706-14  
14 cm/5½"



LUCAE

COTTLE



FO 707-16  
16 cm/6¼"

12



FO 710-20  
20 cm/8"



FO 711-20  
20 cm/8"

12



GRUENWALD

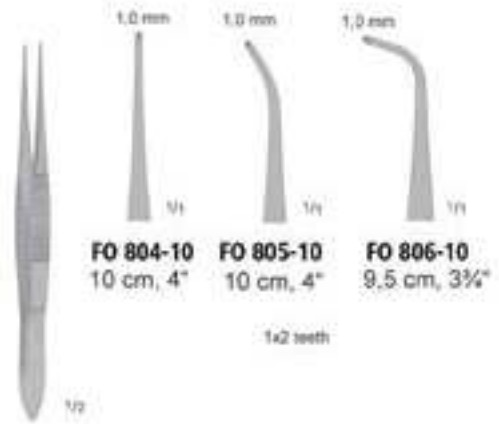
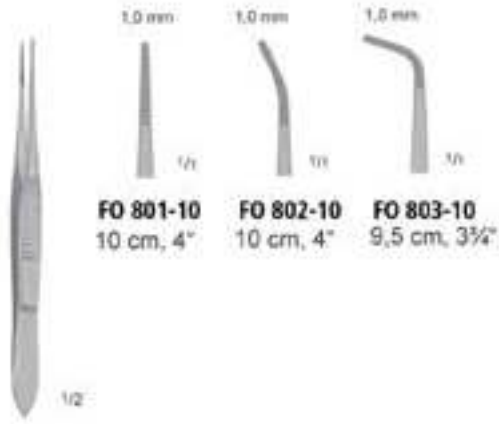

**ATRAUMA**

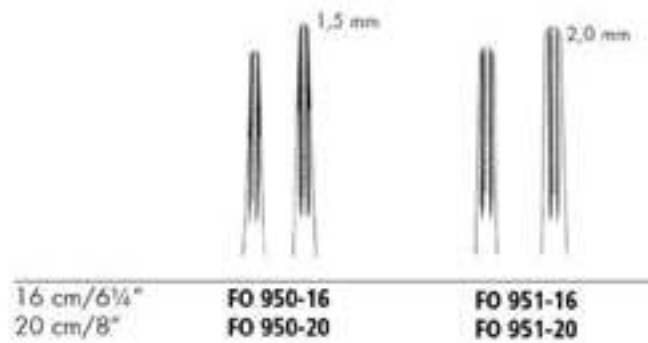



16 cm, 6 1/4"



1/16

**BARBARA**  
**HO 300-01**  
Needle, straight, sharp



1/16

**HO 300-02**  
Needle, slightly curved, sharp



1/16

**HO 300-03**  
Needle, very slightly curved, sharp



1/16

**ROSEN**  
**HO 300-04**  
Needle, strongly curved, sharp



SHAMBAUGH

HO 304-02	0,2 mm
HO 304-03	0,3 mm
HO 304-04	0,4 mm
HO 304-06	0,6 mm
HO 304-08	0,8 mm
HO 304-10	1,0 mm
HO 304-12	1,2 mm
HO 304-15	1,5 mm
HO 304-20	2,0 mm
HO 304-25	2,5 mm

Hooks, angled



SHAMBAUGH

HO 305-02	0,2 mm
HO 305-03	0,3 mm
HO 305-04	0,4 mm
HO 305-06	0,6 mm
HO 305-08	0,8 mm
HO 305-10	1,0 mm
HO 305-12	1,2 mm
HO 305-15	1,5 mm
HO 305-20	2,0 mm
HO 305-25	2,5 mm

Hooks, angled



HO 306-05	0,5 mm
HO 306-10	1,0 mm

Hooks, curved retrograde



GOLDMANN  
 HO 307-01

Retractor for malleus



PLESTER  
 HO 308-01

Antrum hook, angled



PLESTER  
 HO 308-08 0,8 mm

Antrum hook, angled, cylindrical



16 cm, 6 1/4"



**GOLDMANN**  
**HO 311-08** ø 0,8 mm  
 Mobilizer, angled



**GOLDMANN**  
**HO 311-10** ø 1,0 mm  
 Plugger for placing implant material



**ANTOLI-CANDELA**  
**HO 312-18** 1,8 mm  
 Raspatory, curved, for dissection of soft tissue



**ROSEN**  
**HO 313-10** 1,0 mm  
 Raspatory, curved



**ROSEN**  
**HO 313-12** 1,2 mm  
 Raspatory, curved



**ROSEN**  
**HO 313-15** 1,5 mm  
 Raspatory, angled



**HO 314-20** 2,0 mm  
 Raspatory and graft holder, angled



**HOUSE**  
**HO 315-10** 1,0 mm  
 Stapes elevator, angled



16 cm, 6 1/4"



ROSEN

- HO 317-10 ø 1,0 mm
- HO 317-14 ø 1,4 mm
- HO 317-16 ø 1,6 mm
- HO 317-20 ø 2,0 mm
- HO 317-23 ø 2,3 mm
- HO 317-26 ø 2,6 mm
- HO 317-28 ø 2,8 mm
- HO 317-30 ø 3,0 mm

Round cutting knives, angled



- HO 318-10 ø 1,0 mm
- HO 318-15 ø 1,5 mm
- HO 318-20 ø 2,0 mm
- HO 318-23 ø 2,3 mm
- HO 318-25 ø 2,5 mm

Round cutting knives, angled



HOUSE

- HO 319-10 1,0 mm

Lancet knife, angled



HARRISON

- HO 320-15 1,5 mm

Knife for the tympanic membrane, angled



HARRISON

- HO 321-15 1,5 mm

Knife for the tympanic membrane, angled



ROSEN

- HO 322-01

Lancet knife, angled





16 cm, 6¼"



**AUSTIN (PLESTER)**

**HO 322-01**

Sickle knife, curved, very delicate



**PLESTER**

**HO 322-02**

Sickle knife, curved



**PLESTER**

**HO 322-03** 3,5 mm

Flap knife, round cutting



**HO 323-01** 3 x 1 mm

Stapes tendon knife, curved



**GUILFORD-WRIGHT**

**HO 324-01** 2 mm

Flap knife, round cutting



**HOUSE**

**HO 325-01** 4 x 1 mm

Tympanoplasty knife, curved



**TABB**  
**HO 326-01**

Knife for the mucosa and  
tympanoplasty, curved



PLESTER

**HO 327-20** 2,0 mm  
 Scraper, angled, for roughening of tympanum surface.



ROSEN

**HO 328-01**  
 Oval window fenestrator, sharp



PLESTER

**HO 328-02**  
 Wire guide and applicator for prothesis



HUGHES

**HO 329-01**  
 Strip hook



**HO 330-01**

Dissection knife for the footplate, straight



BEALES  
**HO 330-02**

Tension knife



**HO 331-06** 0,6 mm  
 Fenestra hook, retrograde cutting



SHEA

**HO 332-20** 2,0 mm  
 Oblique hook, angled, blunt



AUSTIN

**HO 333-30** 3,0 mm  
 Attic dissector, double angled, blunt



LARKIN

**HO 340-08**  $\varnothing$  0,8 mm  
Hand penetrator



LARKIN

**HO 340-09**  $\varnothing$  0,8 mm  
Hand trephine



LARKIN

**HO 340-10**  $\varnothing$  1,0 mm  
Hand perforator with focal point



GUILFORD-WRIGHT

**HO 341-13** 1,3 mm  
Curette, for tympanoplasty and  
myringoplasty



GUILFORD-WRIGHT

**HO 341-14** 1,3 mm  
Curette, for tympanoplasty and  
myringoplasty



HOUGH

**HO 342-01**  
Measuring rod (caliper),  
marker pins at 3,5 mm,  
4,0 mm and 4,5 mm



ROSEN

**HO 343-20** 2,0 mm  
Curette, for tympanoplasty and  
myringoplasty



16 cm, 6 1/4"



16 cm, 6 1/4"

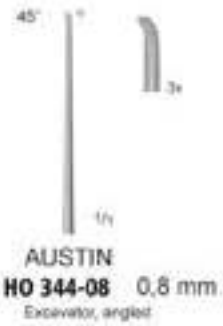

**AUSTIN**  
**HO 344-08** 0,8 mm  
 Excavator, angled

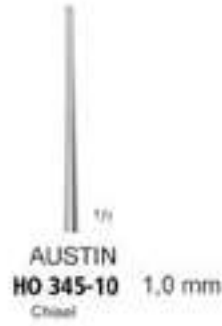

**AUSTIN**  
**HO 345-10** 1,0 mm  
 Chisel



**FISCH**  
**HO 346-01**  
 Excavator, curved right



**FISCH**  
**HO 346-02**  
 Excavator, curved left



**FISCH**  
**HO 347-01**  
 Excavator, double curved right



**FISCH**  
**HO 347-02**  
 Excavator, double curved left

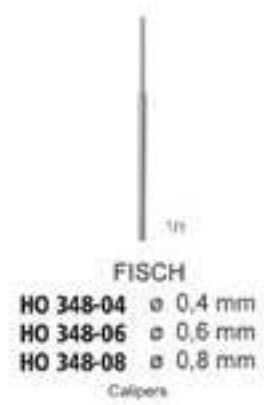

**FISCH**  
**HO 348-04** ø 0,4 mm  
**HO 348-06** ø 0,6 mm  
**HO 348-08** ø 0,8 mm  
 Calipers

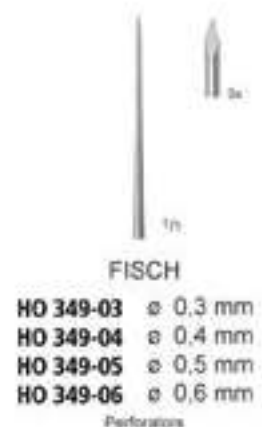

**FISCH**  
**HO 349-03** ø 0,3 mm  
**HO 349-04** ø 0,4 mm  
**HO 349-05** ø 0,5 mm  
**HO 349-06** ø 0,6 mm  
 Perforators



**SCHUKNECHT  
 HO 360-01**  
 Needle, straight, sharp



**BARBARA  
 HO 360-02**  
 Needle, slightly curved,  
 sharp



16 cm, 6 1/4"



**SCHUKNECHT**  
**HO 361-02** 0,2 mm  
**HO 361-03** 0,3 mm  
**HO 361-04** 0,4 mm  
**HO 361-06** 0,6 mm  
**HO 361-08** 0,8 mm  
**HO 361-10** 1,0 mm  
 Hooks, angled up



**SCHUKNECHT**  
**HO 362-02** 0,2 mm  
**HO 362-03** 0,3 mm  
**HO 362-04** 0,4 mm  
**HO 362-06** 0,6 mm  
**HO 362-08** 0,8 mm  
**HO 362-10** 1,0 mm  
 Hooks, angled down



**SCHUKNECHT**  
**HO 363-02** 0,2 mm  
**HO 363-03** 0,3 mm  
**HO 363-04** 0,4 mm  
**HO 363-06** 0,6 mm  
**HO 363-08** 0,8 mm  
**HO 363-10** 1,0 mm  
 Hooks, angled right



**SCHUKNECHT**  
**HO 364-02** 0,2 mm  
**HO 364-03** 0,3 mm  
**HO 364-04** 0,4 mm  
**HO 364-06** 0,6 mm  
**HO 364-08** 0,8 mm  
**HO 364-10** 1,0 mm  
 Hooks, angled left



**SCHUKNECHT**  
**HO 365-02** 0,2 mm  
**HO 365-03** 0,3 mm  
**HO 365-04** 0,4 mm  
**HO 365-06** 0,6 mm  
**HO 365-08** 0,8 mm  
**HO 365-10** 1,0 mm  
 Hooks, angled up



**SCHUKNECHT**  
**HO 366-02** 0,2 mm  
**HO 366-03** 0,3 mm  
**HO 366-04** 0,4 mm  
**HO 366-06** 0,6 mm  
**HO 366-08** 0,8 mm  
**HO 366-10** 1,0 mm  
 Hooks, angled down



16 cm, 6 3/4"



**SCHUKNECHT**  
**HO 367-02** 0,2 mm  
**HO 367-03** 0,3 mm  
**HO 367-04** 0,4 mm  
**HO 367-06** 0,6 mm  
**HO 367-08** 0,8 mm  
**HO 367-10** 1,0 mm  
 Hooks for lifting incus, angled right



**SCHUKNECHT**  
**HO 368-02** 0,2 mm  
**HO 368-03** 0,3 mm  
**HO 368-04** 0,4 mm  
**HO 368-06** 0,6 mm  
**HO 368-08** 0,8 mm  
**HO 368-10** 1,0 mm  
 Hooks for lifting incus, angled left



**MC GEE**  
**HO 371-05** 0,5 mm  
**HO 371-10** 1,0 mm  
 Footplate hooks, curved up



**MC GEE**  
**HO 372-05** 0,5 mm  
**HO 372-10** 1,0 mm  
 Footplate hooks, curved down



**SCHUKNECHT**  
**HO 463-16** ø 3,0 mm  
 Roller knife, horizontal, for incising of external auditory meatus



**SCHUKNECHT**  
**HO 464-16** ø 3,0 mm  
 Roller knife, vertical, for incising of external auditory meatus



**HO 502-15**  
 15 cm, 6"

**HOUSE**  
 Curettes for stapedectomy, oval, cups slightly angled forwards



**HO 503-15**  
 15 cm, 6"

**HOUSE**  
 Curettes for stapedectomy, oval, cups slightly angled forwards



**HO 504-15**  
 15 cm, 6"

**HOUSE**  
 Curettes for stapedectomy, oval, cups strongly angled forwards



**HO 505-15**  
 15 cm, 6"

**HOUSE**  
 Curettes for stapedectomy, oval, cups strongly angled forwards



**HO 480-00**  
 16 cm, 6 1/4"

Preparation tray with mm scala



**HO 506-17**  
 17 cm, 6 3/4"

Curettes for stapedectomy, pointed, cups angled forwards



**HO 507-17**  
 17 cm, 6 3/4"

Curettes for stapedectomy, pointed, cups angled forwards

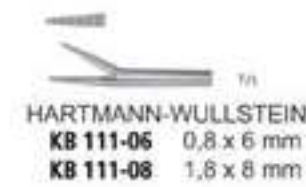
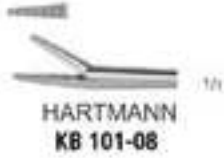





**BELLUCCI**  
**KB 120-01**  
 straight, sharp/sharp



**BELLUCCI**  
**KB 120-02**  
 straight, sharp/sharp



**SHEA-BELLUCCI**  
**KB 120-03**  
 straight, sharp/sharp



**BELLUCCI**  
**KB 120-04**  
 curved up, sharp/sharp



**SHEA-BELLUCCI**  
**KB 120-05**  
 curved up, sharp/sharp



**BELLUCCI**  
**KB 120-06**  
 curved to the right, sharp/sharp



**BELLUCCI**  
**KB 120-07**  
 curved to the right, sharp/sharp



**SHEA-BELLUCCI**  
**KB 120-08**  
 curved to the right, sharp/sharp



**BELLUCCI**  
**KB 120-09**  
 curved to the left, sharp/sharp



**BELLUCCI**  
**KB 120-10**  
 curved to the left, sharp/sharp



**SHEA-BELLUCCI**  
**KB 120-11**  
 curved to the left, sharp/sharp



**TABB**  
**KB 121-01**

Cruro Nipper, 4 x 0.9 mm, straight



**MC GEE**  
**KB 121-02**

Wire bending forceps, 3.5 x 0.9 mm,  
curved downwards



1/2



**MC GEE**  
**KB 121-03**

Wire bending forceps, 5.5 x 0.9 mm,  
curved downwards



**MC GEE**  
**KB 121-04**

Wire bending forceps, 5.5 x 0.9 mm,  
curved downwards to the right



**MC GEE**  
**KB 121-06**

Wire bending forceps, 5.5 x 0.9 mm,  
curved downwards to the left



**DIETER**  
**KB 121-07**

Malleus punch, upwards cutting



**DIETER**  
**KB 121-08**

Malleus punch, downwards cutting



HARTMANN

**KB 128-00**

Set of 3 pieces (ø 1.7/3.2/4.7 mm), stainless steel, satin finish, for children



HARTMANN

**KB 129-00**

Set of 4 pieces (ø 3.2/5.0/6.5/8.0 mm), stainless steel, satin finish, for adults



HARTMANN

**KB 130-00**

Set of 4 pieces (ø 3.5/5.0/6.5/8.0 mm), for adults



POLITZER

**KB 131-00**

Set of 3 pieces (ø 2/3/4 mm), for children

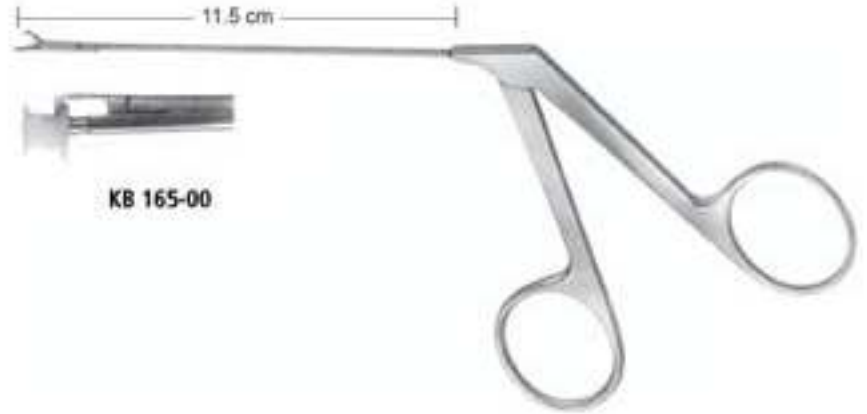

**TILLEY**  
**KB 183-01**  
13,5 cm, 5 1/4"  
Ear tampon forceps



**HARTMANN**  
**KB 184-01**  
12,5 cm, 5"  
Ear tampon forceps, delicate model



**HARTMANN**  
**KB 184-02**  
14,5 cm, 5 3/4"  
Ear tampon forceps, heavy model

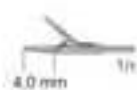

**WULLSTEIN**  
**KB 200-01**  
 serrated jaws, 4 x 1 mm, straight



**WULLSTEIN**  
**KB 200-02**  
 serrated jaws, 5 x 1 mm, straight



**WULLSTEIN**  
**KB 200-03**  
 serrated jaws, 4 x 1 mm, curved up



**WULLSTEIN**  
**KB 200-04**  
 serrated jaws, 6 x 1 mm, curved up



**WULLSTEIN**  
**KB 200-05**  
 serrated jaws, 4 x 1 mm, curved to the right



**WULLSTEIN**  
**KB 200-06**  
 serrated jaws, 6 x 1 mm, curved to the right



**WULLSTEIN**  
**KB 200-07**  
 serrated jaws, 4 x 1 mm, curved to the left



**WULLSTEIN**  
**KB 200-08**  
 serrated jaws, 6 x 1 mm, curved to the left

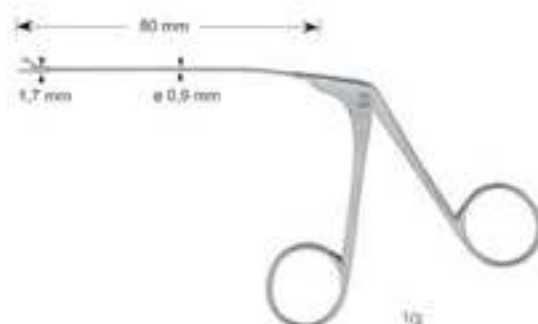

**WULLSTEIN**  
**KB 201-01**  
round cup jaws,  $\varnothing$  1.0 mm, straight



**WULLSTEIN**  
**KB 201-02**  
oval cup jaws, 2.0 x 1.0 mm, straight



**WULLSTEIN**  
**KB 201-03**  
round cup jaws,  $\varnothing$  1.0 mm, curved up



**WULLSTEIN**  
**KB 201-04**  
oval cup jaws, 2.0 x 1.0 mm, curved up



**WULLSTEIN**  
**KB 201-05**  
round cup jaws,  $\varnothing$  1.0 mm, curved to the right



**WULLSTEIN**  
**KB 201-06**  
oval cup jaws, 2.0 x 1.0 mm, curved to the right



**WULLSTEIN**  
**KB 201-07**  
round cup jaws,  $\varnothing$  1.0 mm, curved to the left



**WULLSTEIN**  
**KB 201-08**  
oval cup jaws, 2.0 x 1.0 mm, curved to the left

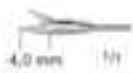

**WULLSTEIN**  
**KB 202-01**  
straight, sharpsharp



**WULLSTEIN**  
**KB 202-02**  
curved up, sharpsharp



**WULLSTEIN**  
**KB 202-03**  
curved left, sharpsharp



**WULLSTEIN**  
**KB 202-04**  
curved right, sharpsharp



**KRAUSE**  
**KB 300-00**  
18 cm, 7"  
Ear polypus snare



**LANGE-WILDE**  
**KB 302-00**  
18 cm, 7"  
Ear polypus snare



**KB 303-00** ø 0,3 mm  
**KB 303-01** ø 0,4 mm

Snare loops, in bundle of 12 pieces



**KB 304-00** ø 0,3 mm  
**KB 304-01** ø 0,4 mm

Snare wire, coil of 10 m



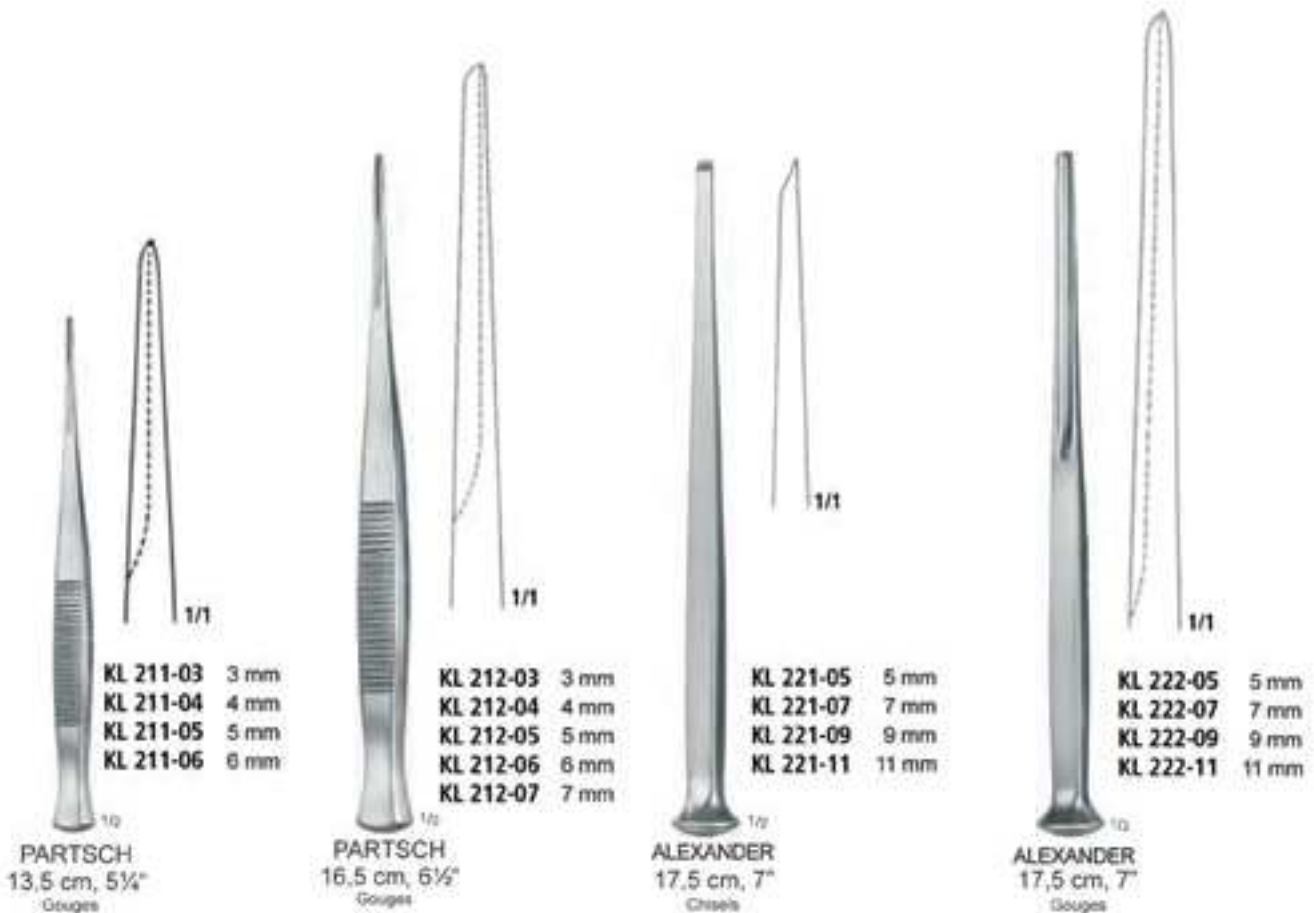
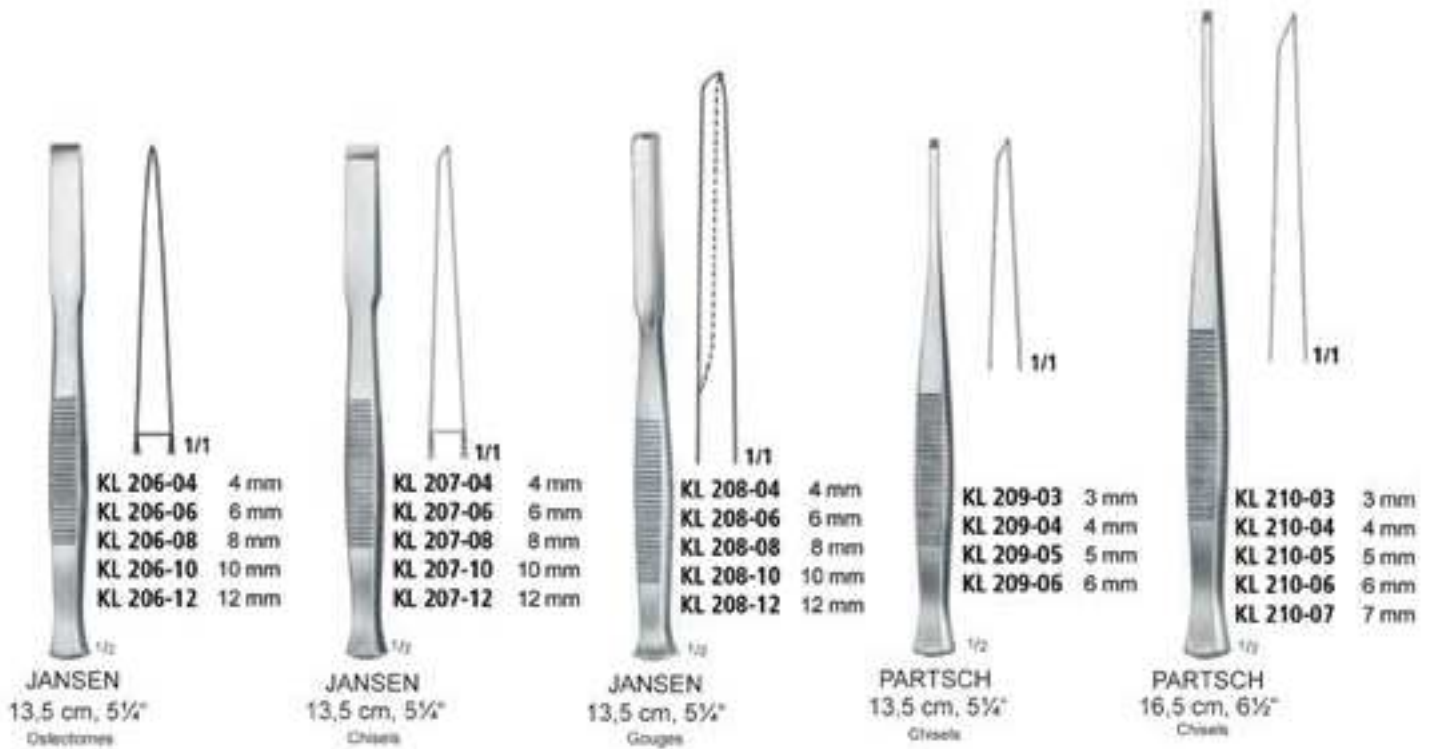

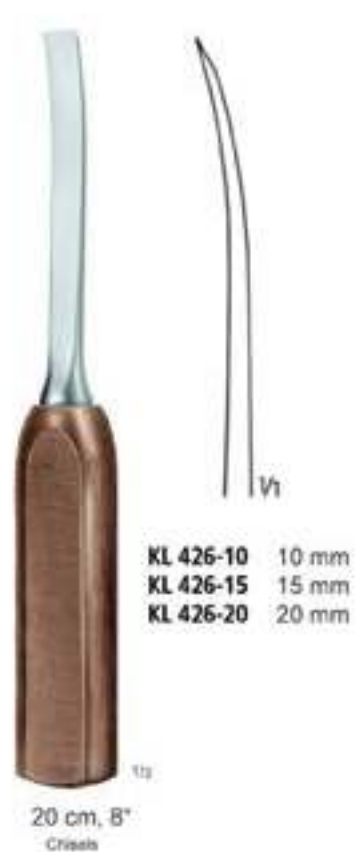



Ø 25 mm

**KB 900-18** 140 gr  
Plastic disks  
18.5 cm



Ø 30 mm

**COTTLE**  
**KB 902-18** 240 gr  
18.5 cm



Ø 20 mm

**MEAD**  
**KL 600-20** 185 gr  
Plastic disc  
19 cm



Ø 22 mm

**KL 600-22** 165 gr  
19 cm



Ø 27 mm

**HAJEK**  
**KL 601-21** 140 gr  
21.5 cm



Ø 30 mm

**KL 602-24** 215 gr  
Plastic disc  
24.5 cm



14,5 cm, 5½"



14,5 cm, 5½"



11,5 cm, 4½"



11,5 cm, 4½"



18,5 cm, 6½"



18,5 cm, 6½"



10,5 cm, 4½"



10,5 cm, 4½"





MA 601-12

**HARVEY**  
12,5 cm, 5"  
Wire cutting scissors,  
1 blade serrated



MA 604-12

**UNIVERSAL**  
12 cm, 4 1/2"  
Wire cutting scissors,  
1 blade serrated



**GOLDMANN-FOX**  
1 blade serrated



MA 710-13  
13 cm, 5 1/4"



MA 711-13  
13 cm, 5 1/4"



**SEALY**



MA 721-11  
11 cm, 4 3/8"



MA 722-11  
11 cm, 4 3/8"



Hard Metal Edged



**METZENBAUM**



**MA 865-11**  
 11,5 cm, 4½"



**MA 866-11**  
 11,5 cm, 4½"



**METZENBAUM**



**MA 867-14**  
 14,5 cm, 5¾"



**MA 875-14**  
 14,5 cm, 5¾"



**MA 877-14**  
 14,5 cm, 5¾"



**MA 868-14**  
 14,5 cm, 5¾"  
 Standard patterns



**MA 876-14**  
 14,5 cm, 5¾"  
 delicate patterns



**MA 878-14**  
 14,5 cm, 5¾"  
 very delicate patterns

Hard Metal Edged



**MA 873-16**  
16 cm, 6 $\frac{1}{4}$ "



**MA 886-11**  
11,5 cm, 4 $\frac{1}{2}$ "



**MA 887-11**  
11,5 cm, 4 $\frac{1}{2}$ "



**MA 886-14**  
14 cm, 5 $\frac{1}{2}$ "





**SUPERCUT**

Hard Metal Edged



BABY-METZENBAUM



MA 891-11  
11,5 cm, 4½"



MA 892-11  
11,5 cm, 4½"



METZENBAUM



MA 891-14  
14,5 cm, 5¾"



MA 892-14  
14,5 cm, 5¾"



METZENBAUM



MA 891-18  
18 cm, 7"



MA 892-18  
18 cm, 7"

Hard Metal Edged



OF 206-14  
14.5 cm



For soft wire  $\varnothing$  1.5 mm  
For hard wire  $\varnothing$  1.0 mm



OF 213-18  
18 cm



For soft wire



For hard wire  $\varnothing$  2.0 mm  
 $\varnothing$  1.5 mm



REILL  
OF 214-17  
17.5 cm



For soft wire  $\varnothing$  2.0 mm  
For hard wire  $\varnothing$  1.6 mm



ANGEL  
OF 218-13 13 cm



**OF 219-01**  
15 cm



**OF 219-02**  
16 cm



**OF 400-14**  
14 cm



17 cm



**OF 450-17**

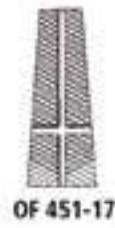

**OF 451-17**



**OF 452-19**  
19 cm



**KERRISON**  
17 cm  $6\frac{3}{4}$ "



**CITELLI**  
 2,5 mm OF 534-02  
 4,0 mm OF 534-04



**BEYER**

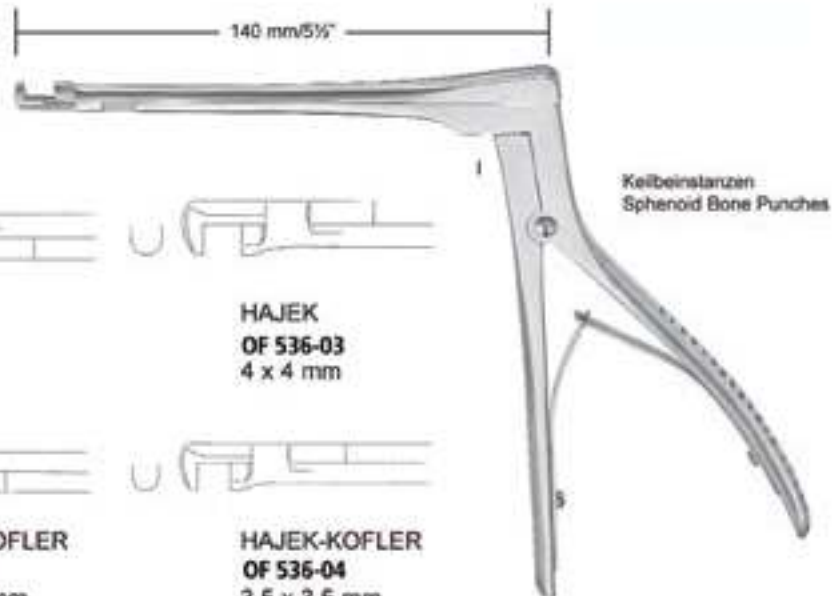

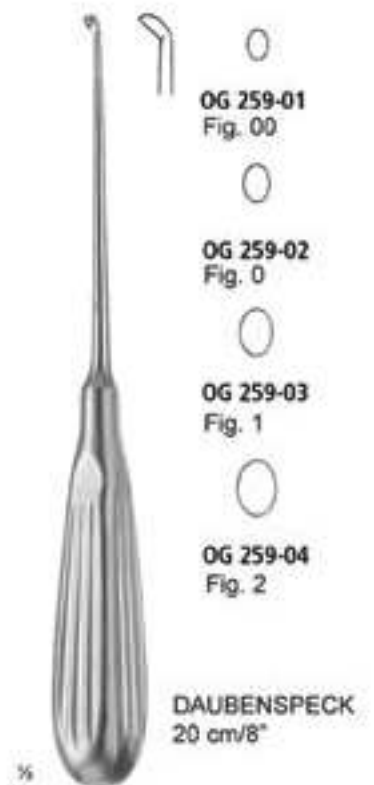

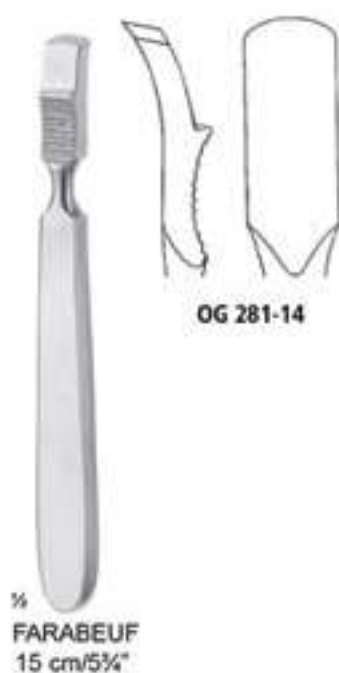
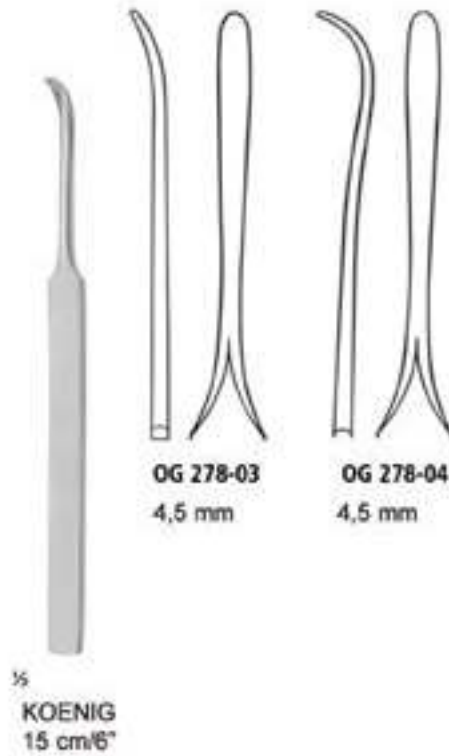







**OG 350-01**  
6 mm



19 cm/7½"



**OG 350-02**  
6 mm



18 cm/7"



**OG 350-03**  
3 mm



18 cm/7"



**OG 350-04**  
6 mm



18 cm/7"



8 mm  
**OG 463-01**



7 mm  
**OG 463-02**



7 mm  
**OG 463-03**



7 mm  
**OG 463-04**



¼  
**ADSON**  
17 cm/6¾"



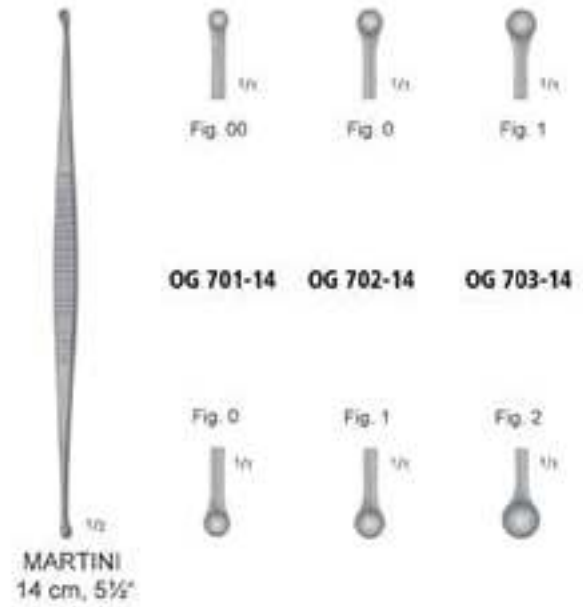

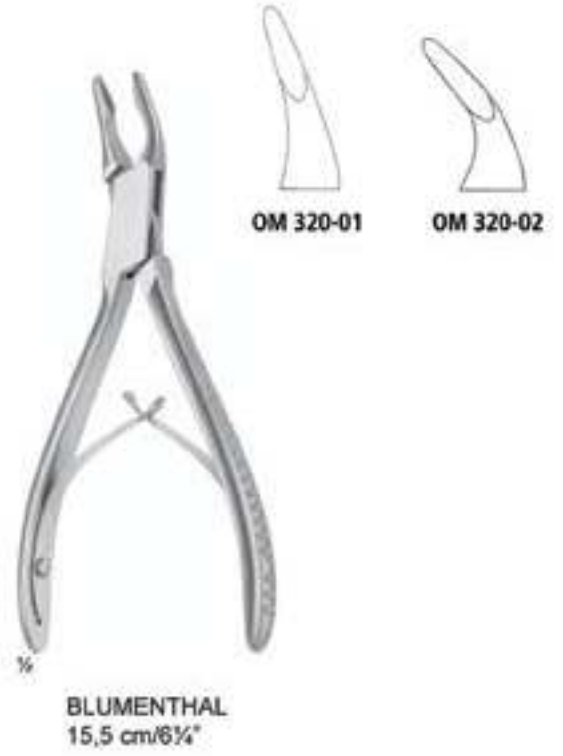
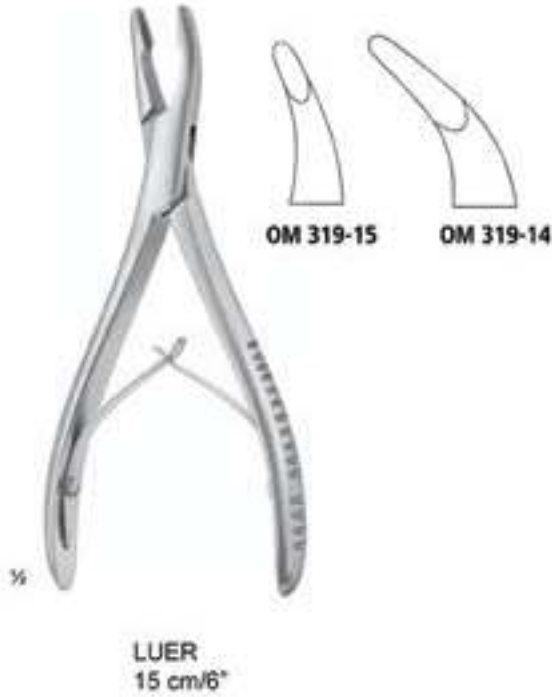



**OM 330-20 OM 331-21**  
 Synovectomy Forceps

**LEMPERT**  
 18,5 cm/7 1/4"



**BEYER**  
**OM 332-18**  
 18 cm/7"



**MEAD**  
**OM 333-16**  
 16 cm/6 1/4"



**OM 335-18**  
 Synovectomy Forceps

**BEYER**  
 18 cm/7"



**OM 338-15 OM 339-15**

**BOEHLER**  
 15 cm/5 3/4"





**NEIVERT**  
13 cm/5 1/4"



**HALSEY**  
13 cm/5 1/4"



**BAUMGARTNER**  
14 cm/5 1/2"



**BABY CRILE WOOD**  
15 cm/6"



**CRILE WOOD**

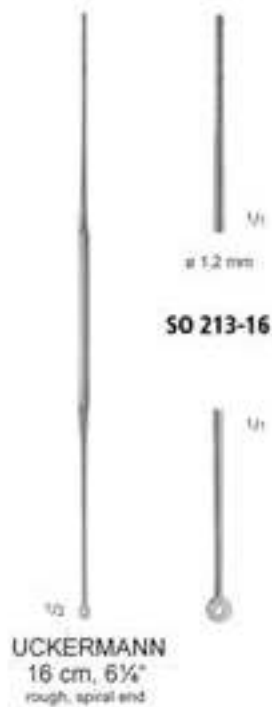
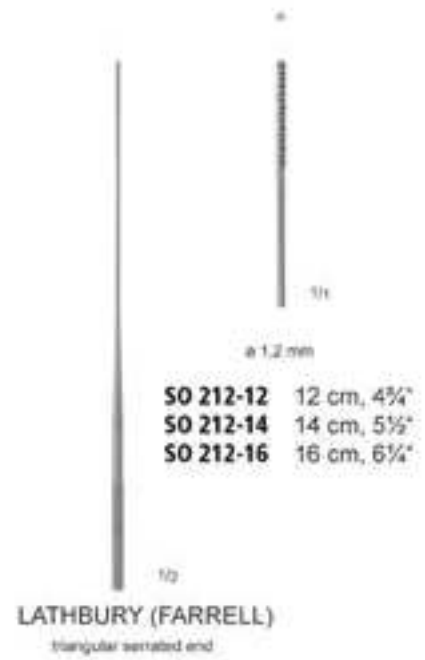
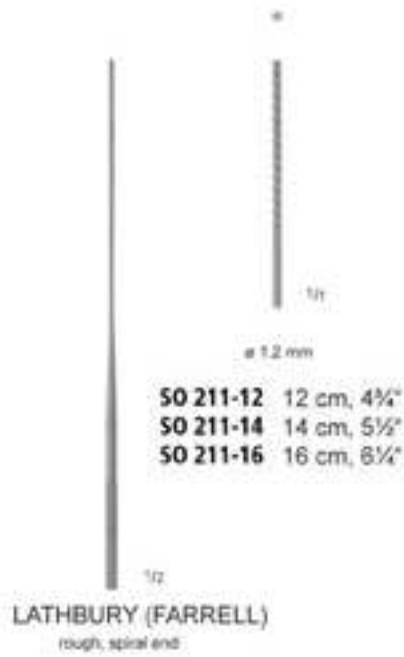



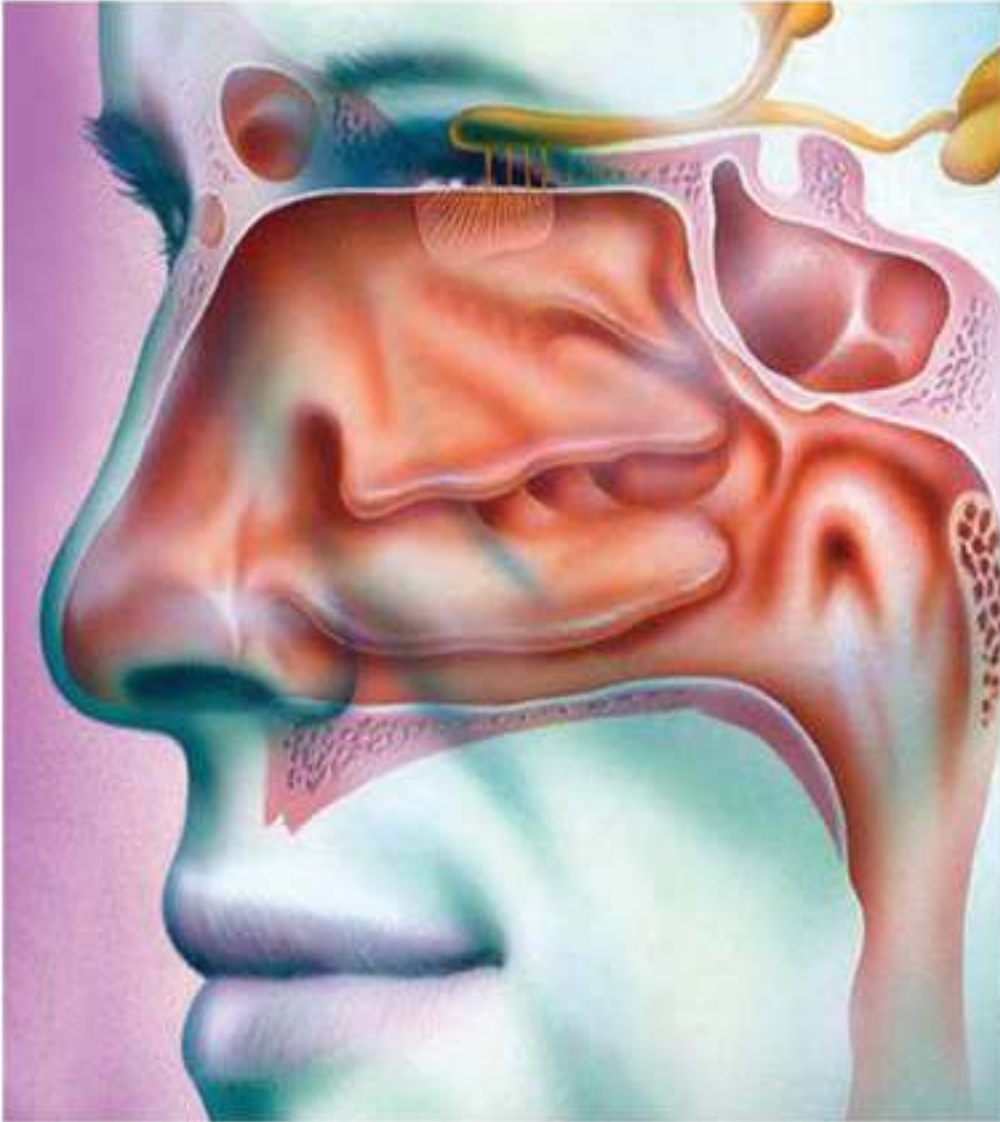

**Rinoloji - Rinoplasti**

**Rhinology - Rhinoplasty**

**Rhinologie - Septum und Nasenplastik**



AS 110-45  $\varnothing$  4,5 mm  
 AS 110-55  $\varnothing$  5,5 mm  
 18,5 cm, 7 $\frac{1}{4}$ "

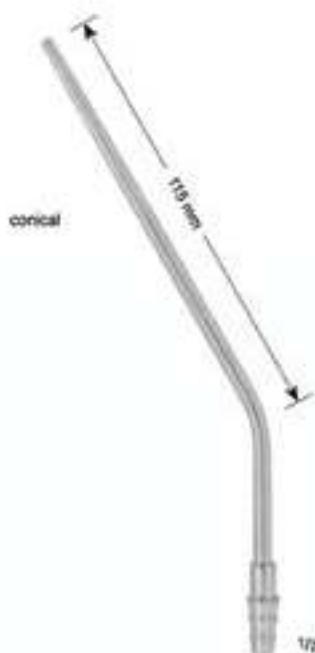

AS 111-30  $\varnothing$  3,0 mm  
 AS 111-35  $\varnothing$  3,5 mm  
 16,5 cm, 6 $\frac{1}{2}$ "



AS 111-45  $\varnothing$  4,5 mm  
 19,5 cm, 7 $\frac{1}{2}$ "



**EICKEN-KILLIAN**  
 AS 115-15  $\varnothing$  1,5 mm  
 AS 115-25  $\varnothing$  2,5 mm  
 AS 115-30  $\varnothing$  3,0 mm  
 14 cm, 5 $\frac{1}{2}$ "  
 Antrum wash cannulae with LUER hub

$\varnothing$ mm	19 cm / 7 $\frac{1}{2}$ "
$\varnothing$ 1,5 mm	AS 120-15
$\varnothing$ 2,0 mm	AS 120-20
$\varnothing$ 2,5 mm	AS 120-25
$\varnothing$ 3,0 mm	AS 120-30
$\varnothing$ 4,0 mm	AS 120-40
$\varnothing$ 5,0 mm	AS 120-50



FRAZIER





1/2

**JOSEPH**  
 15 cm, 6"  
 Rhinoplastic knives,  
 double cutting edges



1/1

**BS 506-01**  
 straight



1/1

**BS 506-02**  
 curved



1/2

**JOSEPH**  
 15 cm, 6"  
 Rhinoplastic knife



1/1

**BS 507-01**



1/2

**JOSEPH**  
 17 cm, 6 3/4"  
 Septum cartilage knife



1/1

**BS 507-02**



1/2

**CONVERSE**  
 16 cm, 6 1/4"  
 Rhinoplastic knife



1/1

**BS 508-01**



1/2

**COTTLE**  
 14 cm, 5 1/2"  
 Septum knife



1/1

**BS 509-01**



1/2

**FOMON**  
 15,5 cm, 6"  
 Rhinoplastic knife  
 double cutting edge



1/1

**BS 510-01**



1/2

**MASING**  
 13,5 cm, 5 1/4"  
 Cartilage slitting knife



1/1

**BS 511-01**

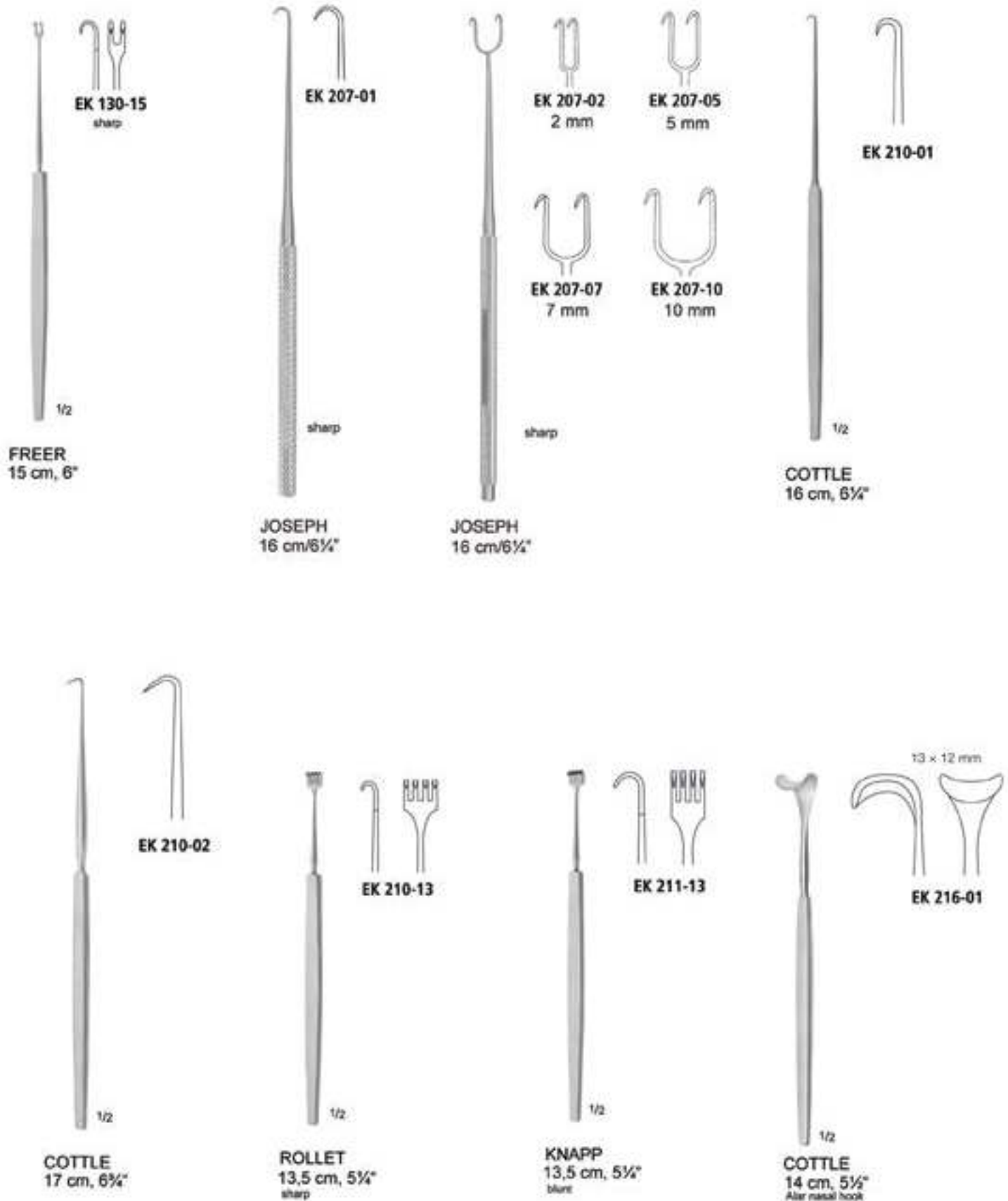

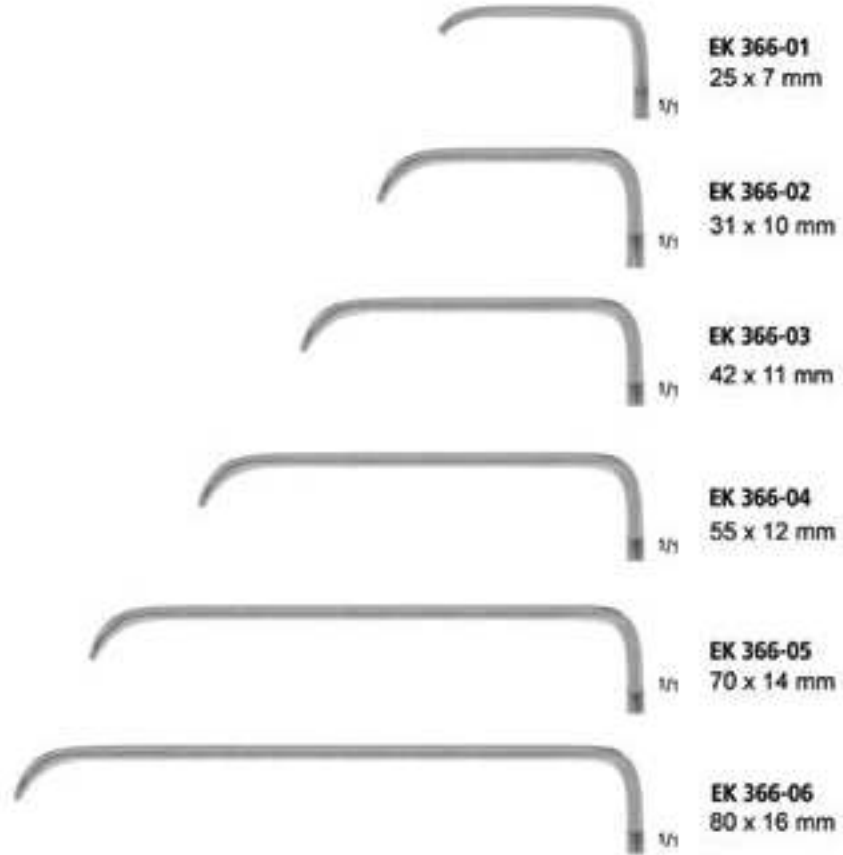
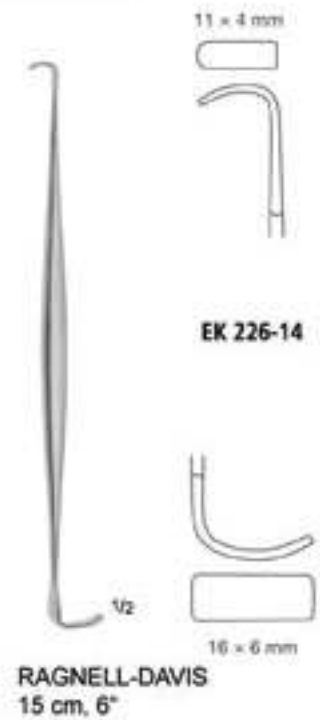
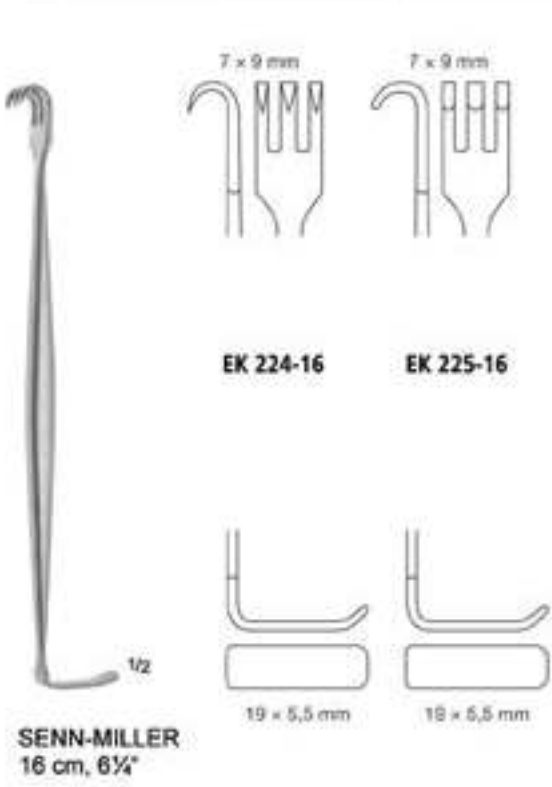

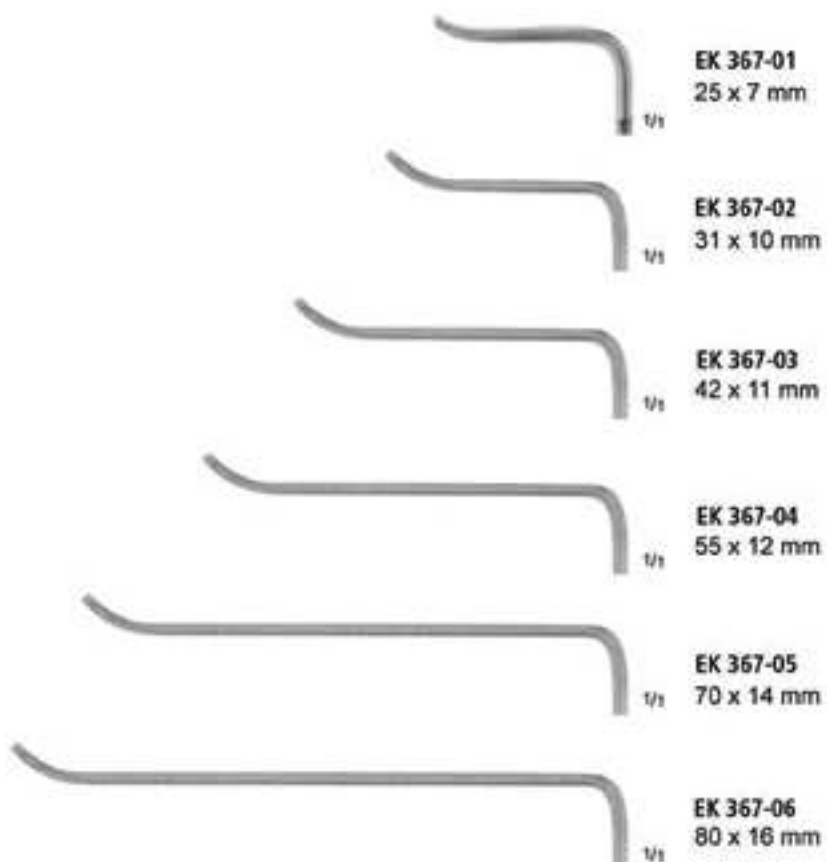



1/2  
**MIDDELDORF**

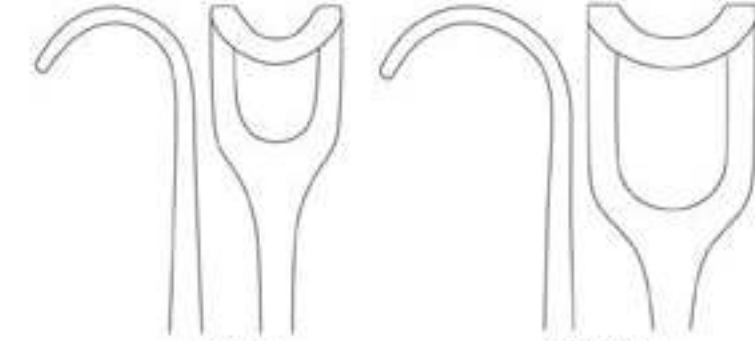

**EK 369-17**  
 16 x 16 mm  
 21,5 cm, 8 1/2"

**EK 369-22**  
 22 x 22 mm  
 22,5 cm, 9"

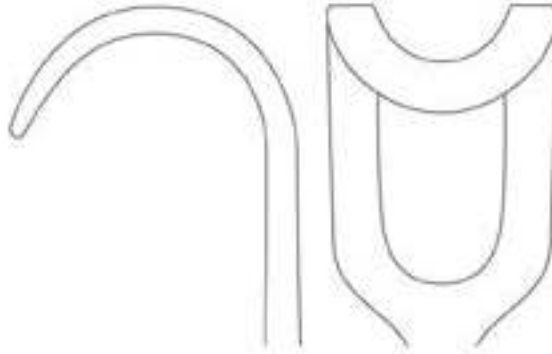

**EK 369-26**  
 30 x 30 mm  
 24,0 cm, 9 1/2"



1/2  
**ROUX**  
**EK 396-01**  
 14,5 cm, 5 3/4"



**BABY-ROUX**  
**EK 398-01**  
 12,5 cm, 4 3/4"

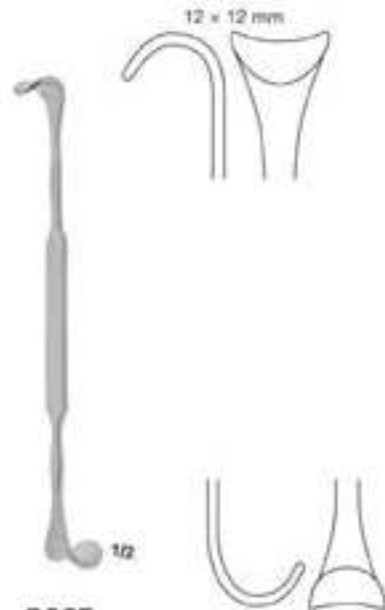

1/2  
**ROSE**  
**EK 403-02**  
 13 cm, 5 1/4"

12 x 10 mm

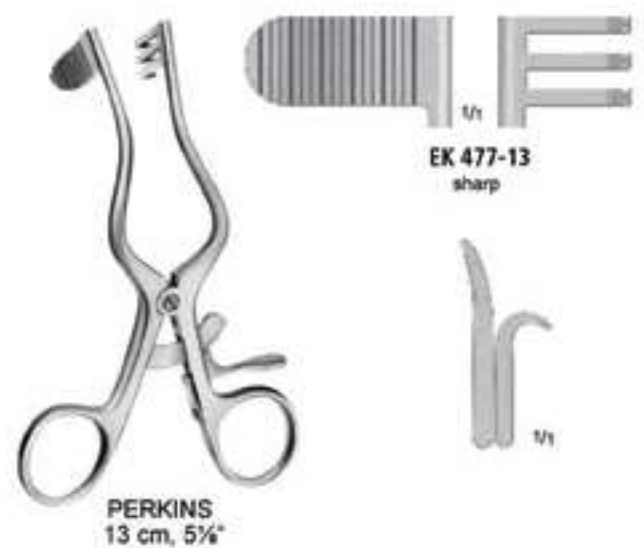
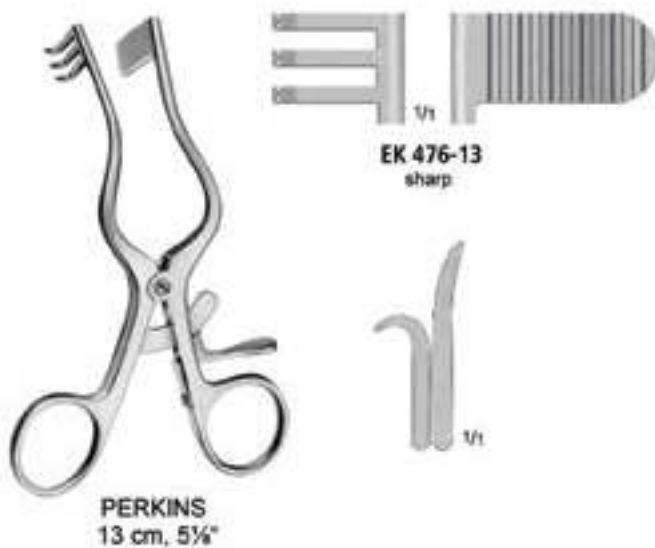
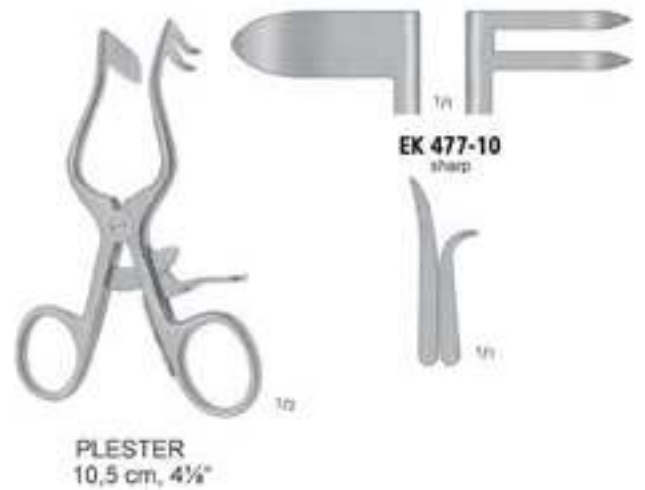
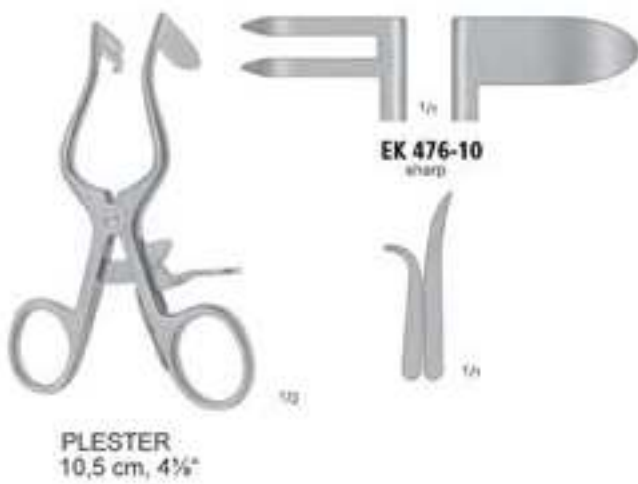
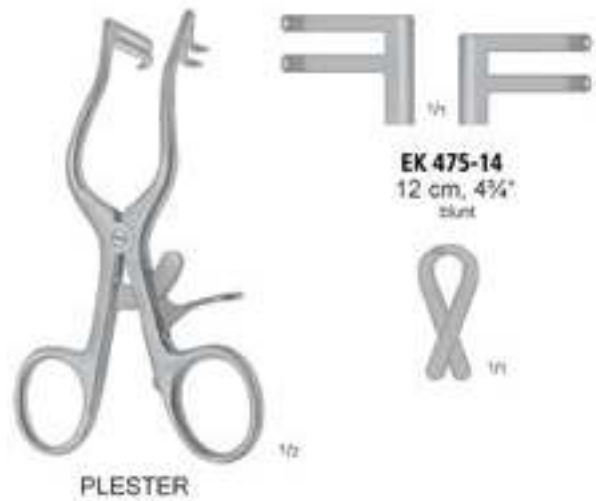
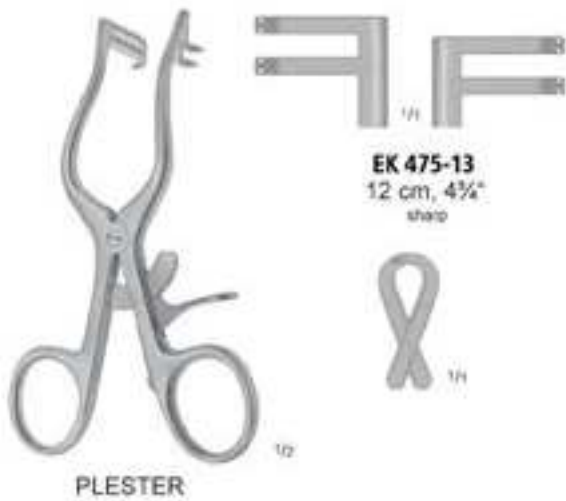



ADSON

12 cm/4¾"	FO 200-12
15 cm/6"	FO 200-15
18 cm/7"	FO 200-18



ADSON micro

12 cm/4¾"	FO 201-12
15 cm/6"	FO 201-15



ADSON

12 cm/4¾"	FO 202-12
15 cm/6"	FO 202-15
18 cm/7"	FO 202-18



ADSON micro

12 cm/4¾"	FO 203-12
15 cm/6"	FO 203-15



ADSON-BROWN  
 12 cm/4¾"



McINDOE  
 15 cm/6"







SEMKEN



FO 226-12  
 12,5 cm/5"



FO 226-15  
 15 cm/6"



SEMKEN



FO 228-12  
 12,5 cm/5"



FO 228-15  
 15 cm/6"



GILLIES



FO 403-15  
 15,5 cm/6"  
 12  
 ← →



ADSON  
 12 cm/4 1/4" FO 405-12  
 15 cm/6" FO 405-15



ADSON  
 12 cm/4 1/4" FO 406-12  
 15 cm/6" FO 406-15



McINDOE



FO 407-15  
 15 cm/6"



**ATRAUMA**



DE BAKEY



DE BAKEY



1,5 mm



2,0 mm

15 cm/6"	FO 410-16	FO 411-16
19,5 cm/7¾"	FO 410-20	FO 411-20
24 cm/9½"	FO 410-24	FO 411-24



**COTTLE**  
**FO 480-10**  
 11 cm, 4 3/4"  
 Columnella forceps,  
 with set-screw



**GILLIES**



**TROELTSCH (WILDE)**  
**FO 700-12**  
 12,5 cm, 5"



**TROELTSCH**  
**FO 700-15**  
 15 cm, 6"



**TROELTSCH**  
**FO 700-18**  
 17 cm, 6 3/4"



**JANSEN**  
 16 cm, 6 1/4"



**COTTLE**  
 14 cm, 5 1/2"  
 Fixation forceps,  
 with teeth and set-screw



**GRUENWALD**  
 16 cm, 6 1/4"  
 1x2 teeth



**GRUENWALD (JANSEN)**  
 19 cm, 7 1/2"



**GRUENWALD**  
 19 cm, 7 1/2"  
 1x2 teeth

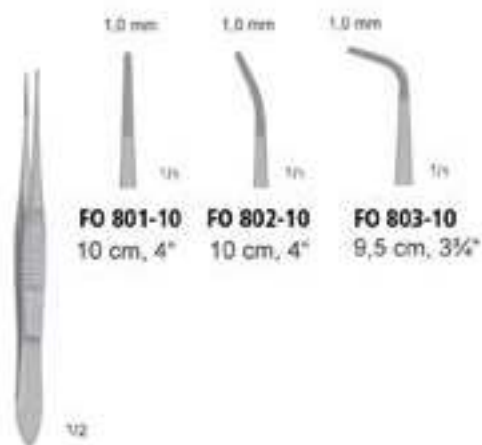

**FO 801-10**  
 10 cm, 4"

**FO 802-10**  
 10 cm, 4"

**FO 803-10**  
 9,5 cm, 3 3/4"

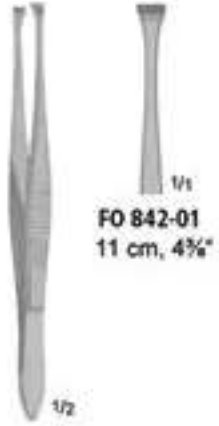

FO 842-01  
 11 cm, 4 3/4"

**GRAEFE**  
 Skin grasping forceps,  
 5x6 teeth



**CASTROVIEJO**  
 with tying platform



FO 843-05  
 10 cm, 4"  
 teeth 0.5 mm



FO 843-09  
 10 cm, 4"  
 teeth 0.9 mm



FO 843-15  
 10 cm, 4"  
 teeth 1.5 mm

**ATRAUMA**



DE BAKEY



**CASTROVIEJO**  
 with tying platform



FO 942-01  
 11 cm, 4 3/4"  
 teeth 0.15 mm



FO 942-03  
 11 cm, 4 3/4"  
 teeth 0.3 mm



FO 942-05  
 11 cm, 4 3/4"  
 teeth 0.5 mm



DE BAKEY



16 cm/6 1/4" FO 950-16  
 20 cm/8" FO 950-20

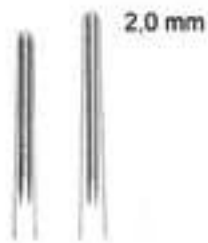

16 cm/6 1/4" FO 951-16  
 20 cm/8" FO 951-20



ADSON Baby

**HM 415-14**  
 14 cm/5½"



HALSTED-MOSQUITO micro

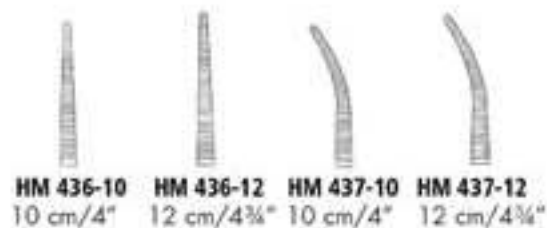

**HM 436-10** 10 cm/4"  
**HM 436-12** 12 cm/4¾"  
**HM 437-10** 10 cm/4"  
**HM 437-12** 12 cm/4¾"

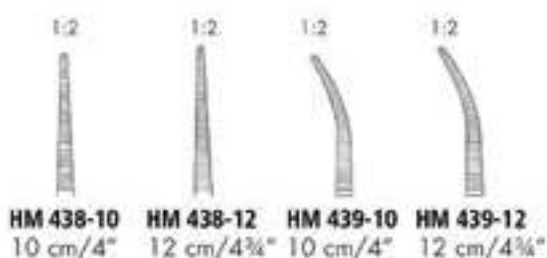

**HM 438-10** 10 cm/4"  
**HM 438-12** 12 cm/4¾"  
**HM 439-10** 10 cm/4"  
**HM 439-12** 12 cm/4¾"



HALSTED-MOSQUITO

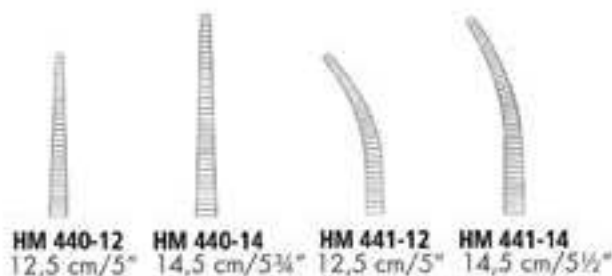

**HM 440-12** 12,5 cm/5"  
**HM 440-14** 14,5 cm/5¾"  
**HM 441-12** 12,5 cm/5"  
**HM 441-14** 14,5 cm/5¾"

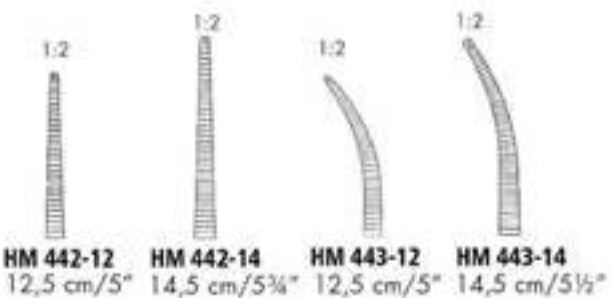

**HM 442-12** 12,5 cm/5"  
**HM 442-14** 14,5 cm/5¾"  
**HM 443-12** 12,5 cm/5"  
**HM 443-14** 14,5 cm/5½"



Baby MIXTER  
 14 cm/5½"

**HM 520-02**



HALSTEAD-MOSQUITO

**KA 150-01**  
 12 cm/4¾"



**KA 150-02**  
 12 cm/4¾"



**ATRAUMA**



DE BAKEY

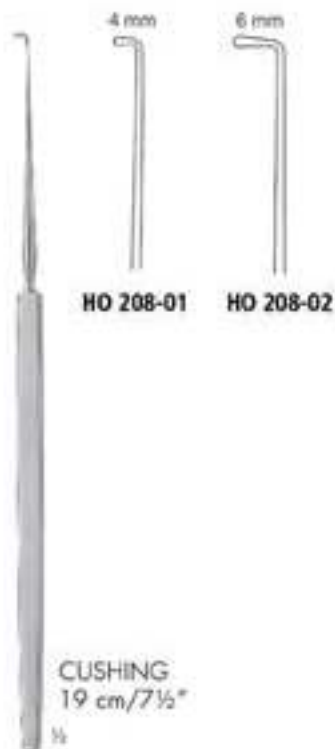

Bone and cartilage crusher with clamp for taking out the prepared material



**COTTLE**  
**KB 161-00**  
65 x 27 x 27 mm

1/2





**HARTMANN**  
**KB 185-01**  
 16 cm, 6 1/4"



**HARTMANN**  
**KB 185-02**  
 20 cm, 8"

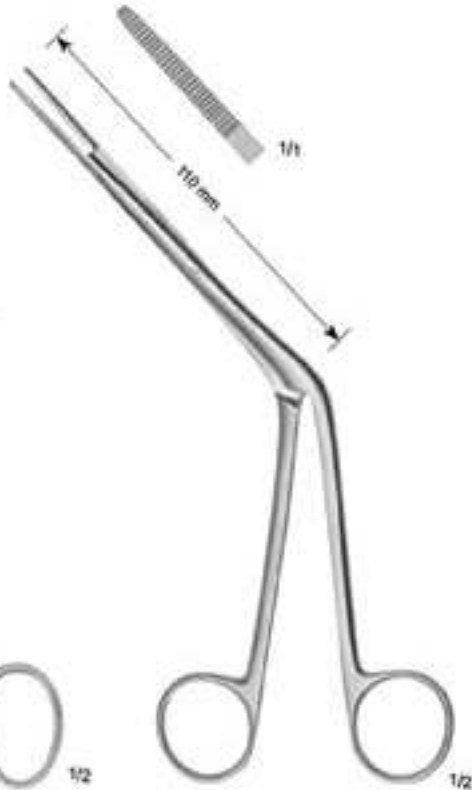

**WEST**  
**KB 186-20**  
 20 cm, 8"

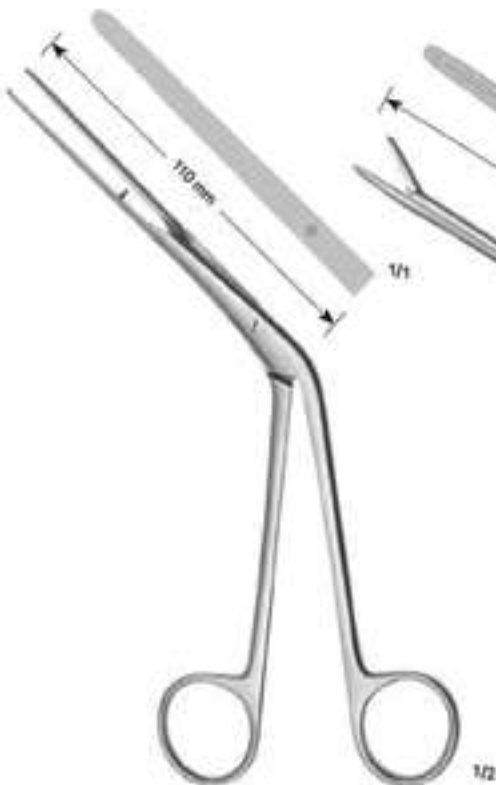

**LUBET-BARBON**  
**KB 187-20**  
 20 cm, 8"

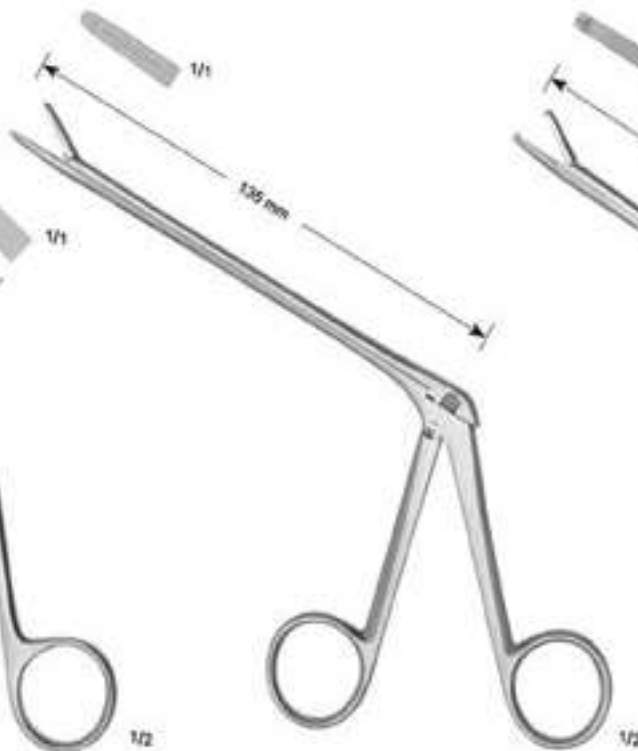

**NOYES**  
**KB 188-01**  
 20 cm, 8"

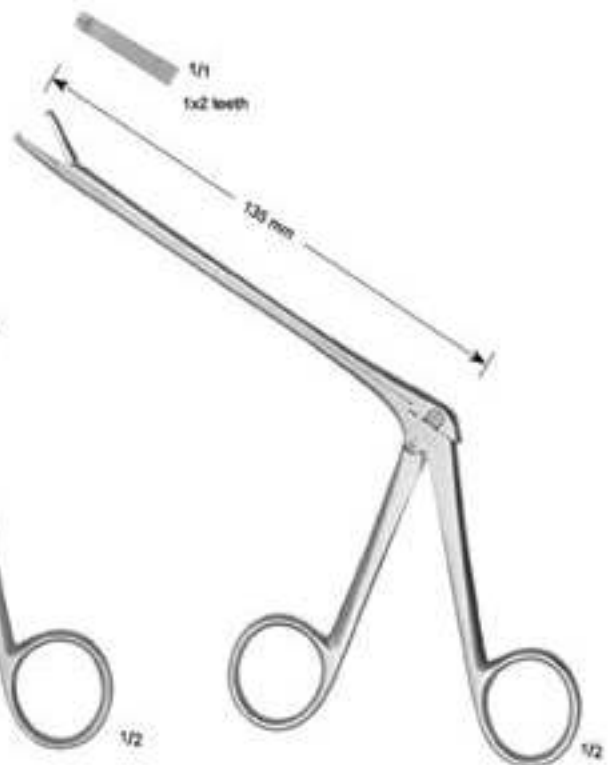

**NOYES**  
**KB 188-02**  
 20 cm, 8"



THUDICHUM GOLDSMITH  
 6,5 cm, 2½"



KB 250-01



KB 250-02



KB 250-03



KB 250-013  
 for babies



KB 251-13  
 for infants



TIECK-HALLE  
 13,5 cm, 5¼"  
 with screw joint



HARTMANN-HALLE  
 15,5 cm, 6¼"  
 with aseptic joint



KB 250-15



KB 251-15



KB 252-15



KB 250-16



KB 251-16



KB 252-16



HARTMANN-HALLE  
 15,5 cm, 6¼"  
 with screw joint



**BECKMANN**  
 13 cm, 5 1/4"  
 with screw joint



**KB 255-14**  
 for babies



**BECKMANN**  
 15 cm, 6"  
 with screw joint



**KB 256-15**



**HARTMANN**  
 16 cm, 6 1/4"  
 with aseptic joint



**KB 257-16**



**KB 258-16**



**KB 259-16**



**MOD. WIEN**  
 13,5 cm, 5 1/4"  
 with aseptic joint



**KB 259-14**



**KILLIAN**  
14 cm, 5½"  
with screw joint

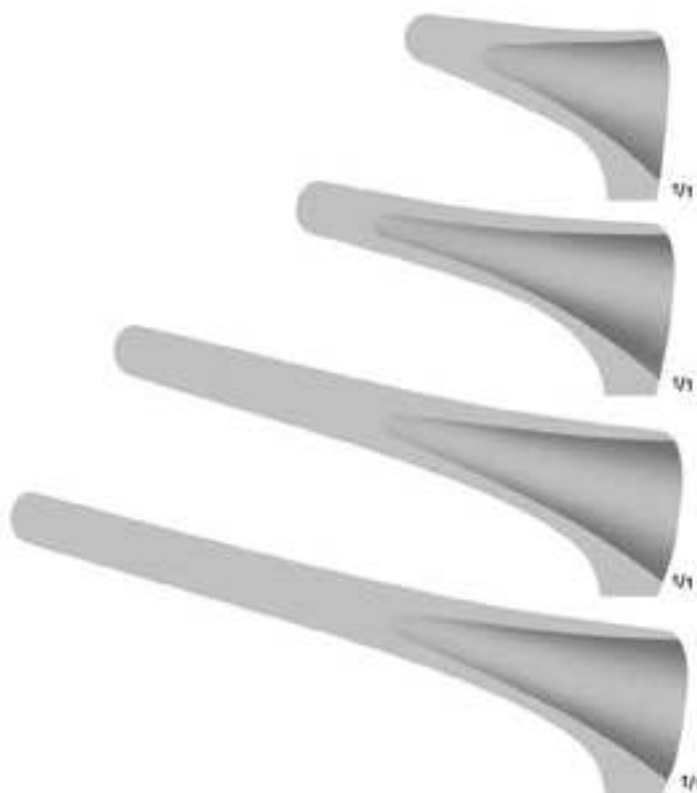

**KB 260-01**  
35 mm

**KB 260-02**  
50 mm

**KB 260-03**  
75 mm

**KB 260-04**  
90 mm



**KILLIAN**  
14 cm, 5½"  
with aseptic joint

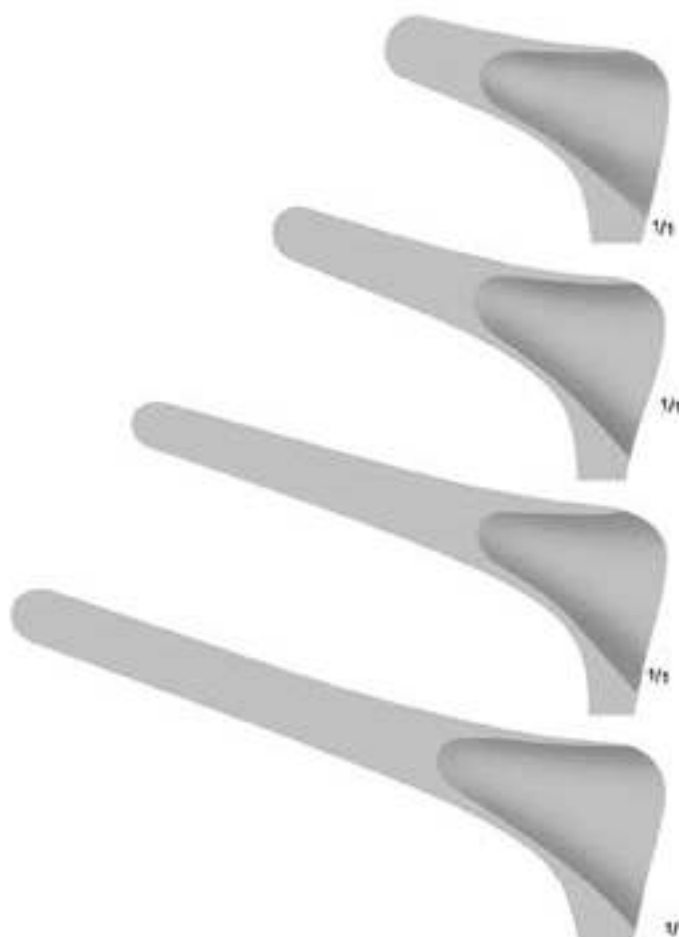

**KB 261-01**  
40 mm

**KB 261-02**  
55 mm

**KB 261-03**  
75 mm

**KB 261-04**  
90 mm



**KB 262-01**  
35 mm



**KB 262-02**  
55 mm



**COTTLE**  
13,5 cm, 5½°  
with aseptic joint and set-screw



**KB 262-03**  
75 mm



**KB 262-04**  
90 mm



**KRAUSE**  
**KB 300-00**  
 26 cm, 10 1/4"  
 with 1 cannula



**KRAUSE-VOSS**  
**KB 301-00**  
 26 cm, 10 1/4"  
 with 1 cannula, vertical opening and 1 cannula,  
 horizontal opening



**LANGE-WILDE**  
**KB 302-00**  
 23 cm, 9"



**KB 303-00** ø 0,30 mm  
**KB 303-01** ø 0,35 mm  
 Snare loops, in bundle of 12 pieces



**KB 304-00** ø 0,3 mm  
**KB 304-01** ø 0,4 mm  
 Snare wire, coil of 10 m



**KB 311-01**  
straight, 1 blade serrated

1/1



**KB 311-02**  
curved to the right, 1 blade serrated

1/1



**KB 311-03**  
curved to the left, 1 blade serrated

1/1

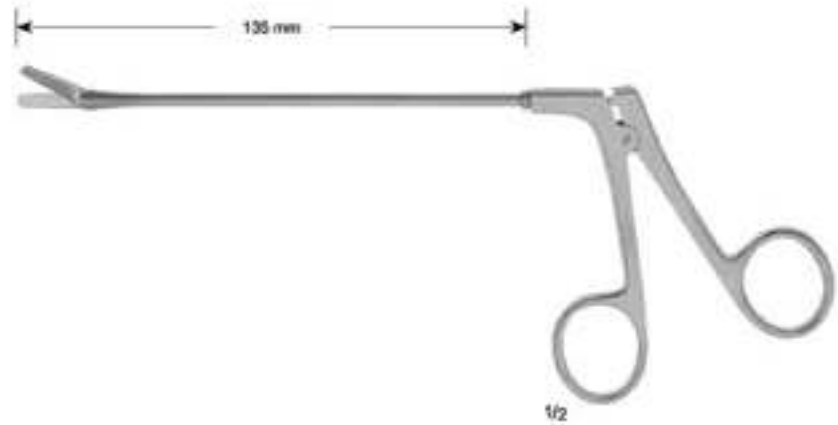

1/2



**KB 312-01**  
straight, 1 blade serrated

1/1



**KB 312-02**  
curved to the right, 1 blade serrated

1/1



**KB 312-03**  
curved to the left, 1 blade serrated

1/1

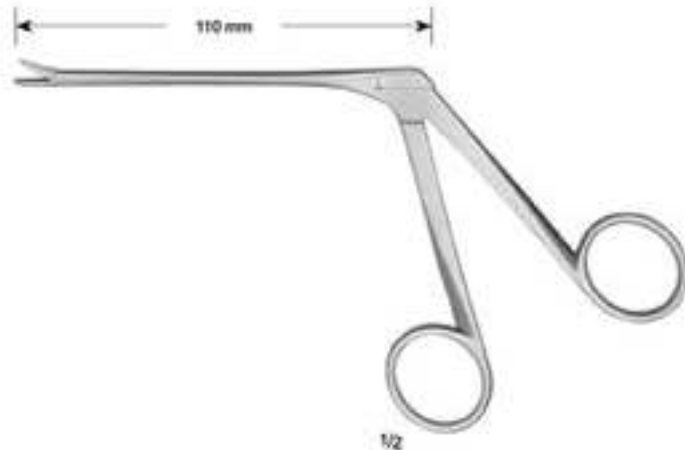

1/2



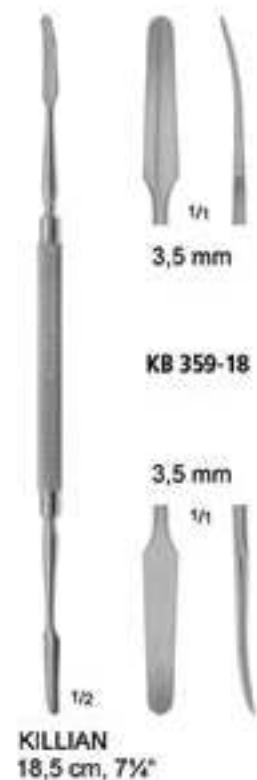



**MC KENTY**  
 15 cm, 6"



**KB 364-01**  
 3 mm



**KB 364-02**  
 4 mm



**KB 364-03**  
 5 mm



**KB 367-16**  
 4 mm



**FREER**  
 17 cm, 6 1/2"  
 Septum chisel,  
 straight

1/2



**FREER**  
 17cm, 6 1/2"  
 Septum chisel,  
 curved

1/2



**KB 368-16**  
 4 mm



**KB 369-01**  
 2 mm



**KB 369-02**  
 3 mm



**KB 369-03**  
 4 mm



**KB 369-04**  
 5 mm



**LEMPERT**  
 17 cm, 6 1/2"

1/2



1/2

**GILLIES**  
KB 375-01  
20 cm, 8"

Zygoma elevator, angled,  
blunt



1/2

**BOIES**  
KB 375-02  
19 cm, 7½"

Nasal fracture elevator,  
blunt



1/2

**GOLDMANN**  
KB 375-03  
20 cm, 8"

Septum fracture  
elevator, blunt



1/2

**DINGMANN**  
KB 375-04  
21 cm, 8¼"

Zygoma elevator, curved,  
blunt



**BALLENGER**  
20 cm, 8"  
Septum swivel knives  
1/2



**KB 410-01**  
3 mm



**KB 410-02**  
4 mm



**KB 410-03**  
5 mm



**BALLENGER**  
20 cm, 8"  
Septum swivel knives  
1/2



**KB 411-03**  
3 mm



**KB 411-04**  
4 mm



**KB 411-05**  
5 mm



**JANSEN**  
KB 415-20  
19,5 cm, 7 $\frac{3}{4}$ "  
Septum forceps, spoon shaped  
jaws



**JANSEN-MIDDLETON**  
KB 416-21  
19 cm, 7 $\frac{1}{2}$ "  
Septum forceps, through cutting



**KB 417-01**  
3 mm

**KB 417-02**  
4 mm

**KRESSNER**  
22 cm, 8 $\frac{1}{4}$ "  
Tubinate crushing forceps



**COTTLE-WALSHAM**  
23 cm, 9"

1/2



1/1

**KB 418-01**  
straight



1/1

**KB 418-02**  
left



1/1

**KB 418-03**  
right



**ASCH**  
22,5 cm, 9"

1/2



1/1

**KB 419-23**



**FREER**  
15 cm, 6"

**KB 420-15**  
6 mm



**BALLENGER**  
16 cm, 6 1/4"

**KB 421-15**  
6 mm



**KILLIAN-CLAUS**  
17 cm, 6 1/4"

**KB 422-17**  
5 mm



**KILLIAN**  
17 cm, 6 1/4"

**KB 423-17**  
5 mm





**HEYMANN**  
 KB 427-19  
 18,5 cm, 7 1/4"  
 Septum forceps



**CRAIG**  
 KB 428-01  
 16,5 cm, 6 1/2"  
 Vomer forceps

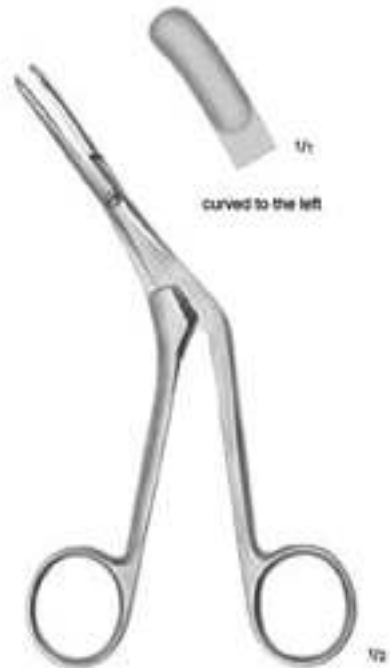

**CRAIG-DOMINICK**  
 KB 428-02  
 16,5 cm, 6 1/2"  
 Vomer forceps



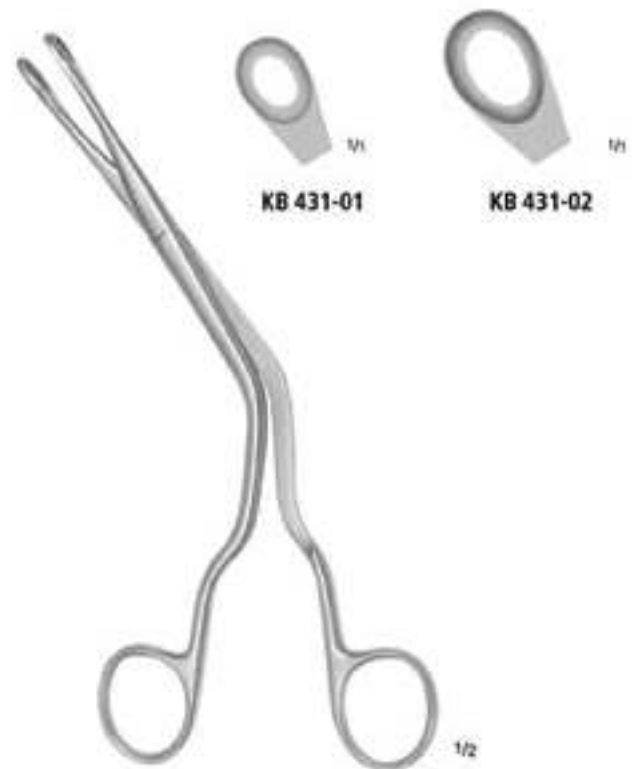

**BRUENINGS**  
 18 cm, 7"  
 fenestrated jaws



**LUC**  
 20 cm, 8"  
 fenestrated jaws

 1/4 **KB 432-01** 6,5 mm

 1/4 **KB 432-02** 8,0 mm

 1/4 **KB 432-03** 9,5 mm

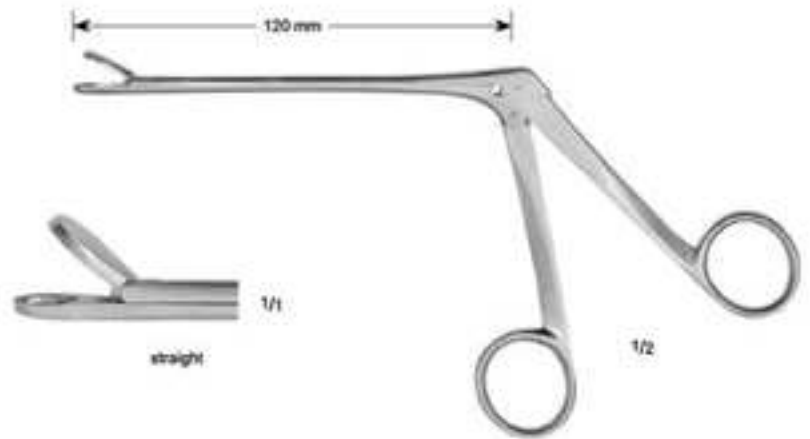

WATSON-WILLIAMS

 1/4 **KB 433-01**  
3,0 mm  
straight

 1/4 **KB 433-02**  
3,0 mm  
45° upwards curved



TAKAHASHI

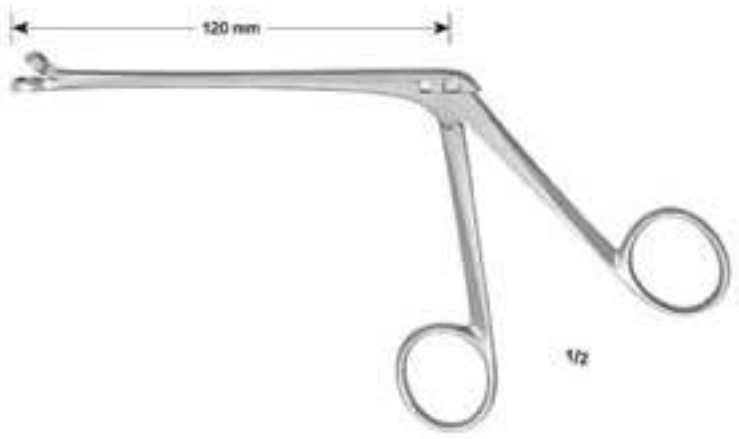
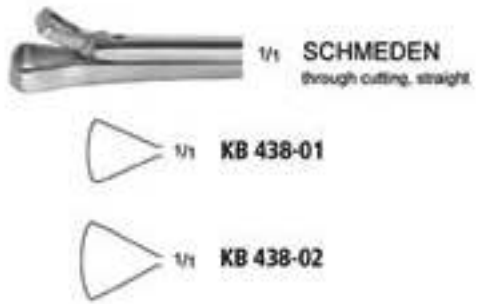
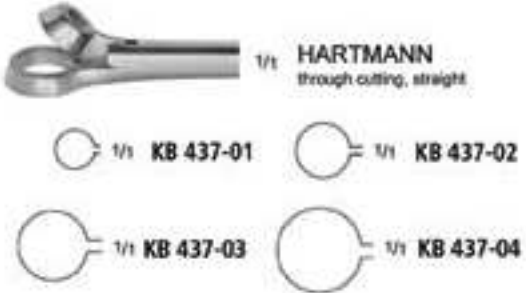
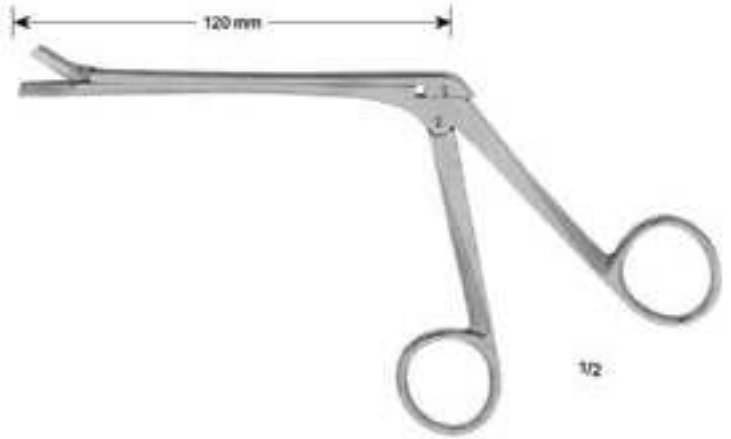
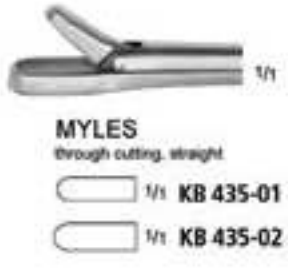

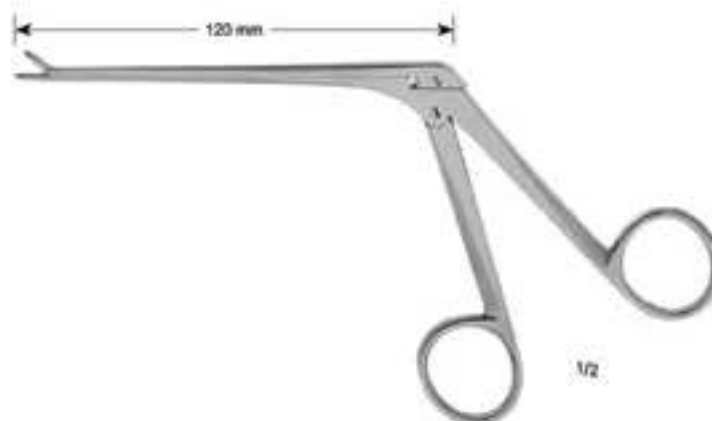





WEIL-BLAKESLEY



straight



45° upwards curved

	1/16	<b>KB 450-01</b>	3,0 mm
	1/16	<b>KB 450-02</b>	3,6 mm
	1/16	<b>KB 450-03</b>	4,2 mm
	1/16	<b>KB 450-04</b>	4,8 mm
	1/16	<b>KB 450-05</b>	5,6 mm

	1/16	<b>KB 451-01</b>	3,6 mm
	1/16	<b>KB 451-02</b>	4,2 mm
	1/16	<b>KB 451-03</b>	4,8 mm



90° upwards curved

	1/16	<b>KB 453-01</b>	3,0 mm
	1/16	<b>KB 453-02</b>	3,6 mm
	1/16	<b>KB 453-03</b>	4,2 mm
	1/16	<b>KB 453-04</b>	4,8 mm

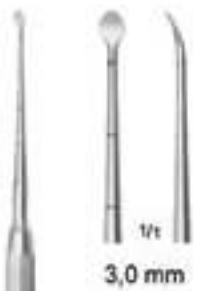

1/1  
 3,0 mm

**KB 460-20**



2,0 mm  
 1/1

1/2  
**COTTLE**  
 20 cm, 8"



1/1

**KB 460-21**

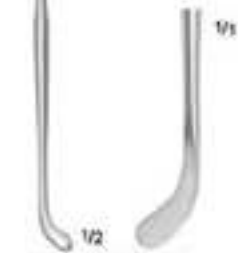

1/1

1/2  
**PENNINGTON**  
 22 cm, 8 3/4"



1/1

4,5 mm

**KB 461-20**

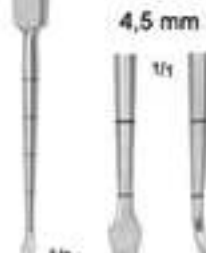

1/1

4,5 mm

1/2  
**MASING**  
 21,5 cm, 8 1/2"



1/1

4,5 mm

**KB 462-20**

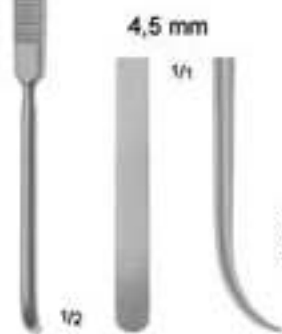

4,5 mm  
 1/1

1/2  
**COTTLE**  
 23 cm, 9"



1/1

**KB 463-20**  
 8 mm

1/2  
**COTTLE**  
 19 cm, 7 1/2"

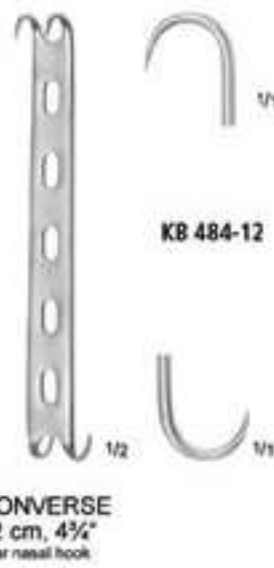
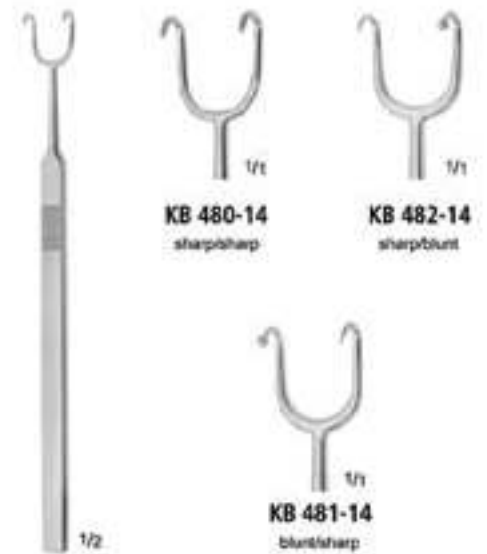
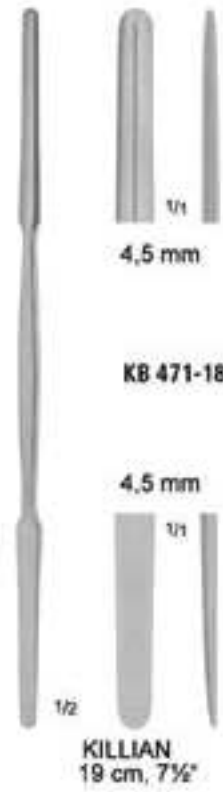
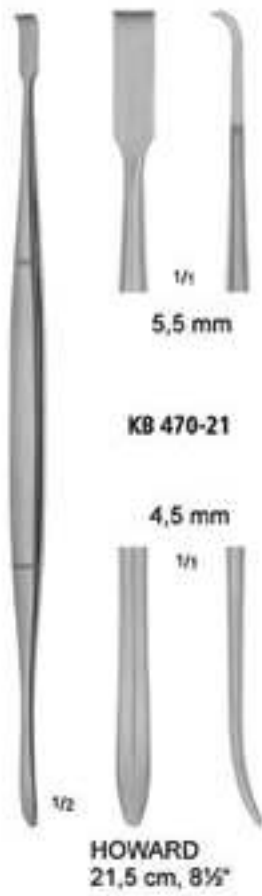



**KB 486-16**  
button ended

1/2

**FOMON**  
16 cm, 6 1/4"



**KB 487-12**  
45 x 8 mm

1/2

**WALTER**  
12 cm, 4 3/4"  
Nasal ridge retractor



1/2

**AUFRICHT**  
16 cm, 6 1/4"  
Nasal ridge retractor



**KB 488-16**  
46 x 10 mm



1/2

**COTTLE**  
15,5 cm, 6 1/4"  
Alar nasal hook



**KB 489-15**





**COTTLE**  
 KB 491-04 4 mm  
 KB 491-06 6 mm  
 KB 491-08 8 mm  
 KB 491-10 10 mm  
 KB 491-12 12 mm  
 18 cm, 7"  
 Osteotomes, graduated,  
 straight



**COTTLE**  
 KB 492-04 4 mm  
 KB 492-06 6 mm  
 KB 492-08 8 mm  
 KB 492-10 10 mm  
 KB 492-12 12 mm  
 18 cm, 7"  
 Chisels, graduated,  
 straight



**COTTLE**  
 6 mm  
 18 cm, 7"  
 Osteotome, graduated,  
 curved, for transversal  
 osteotomy  
**KB 493-06**



**WALTER**  
 KB 494-03 3,0 mm  
 KB 494-04 4,5 mm  
 19 cm, 7 1/2"  
 Gouges, straight

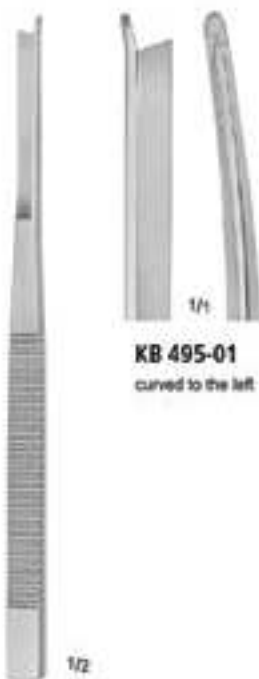

**SILVER (MASING)**  
 17,5 cm, 7"



**KB 495-01**  
 curved to the left



**KB 495-02**  
 curved to the right



**KB 495-03**  
 straight



**OBWEGESER**  
 18,5 cm, 7 1/4"  
 Septum osteotomes, curved



**KB 496-04**  
 4 mm



**KB 496-06**  
 6 mm



**KB 496-08**  
 8 mm



**CINELLI**  
 16 cm, 6 1/4"  
 Osteotomes, straight



**KB 497-10**  
 10 mm



**KB 497-12**  
 12 mm



**KB 497-14**  
 14 mm



**KB 497-16**  
 16 mm



1/2

**MINI-LAMBOTTE**  
 KB 498-02 2 mm  
 KB 498-03 3 mm  
 KB 498-04 4 mm  
 KB 498-06 6 mm  
 KB 498-08 8 mm  
 KB 498-10 10 mm  
 KB 498-12 12 mm  
 KB 498-15 15 mm  
 12,5 cm, 5"  
 Osteotomes, straight



1/4



1/4



1/2

**FOMON**  
 KB 499-04 4 mm  
 KB 499-05 5 mm  
 KB 499-06 6 mm  
 KB 499-08 8 mm  
 15 cm, 6"



1/2

**COTTLE**  
 KB 501-02 2 mm  
 KB 501-04 4 mm  
 KB 501-06 6 mm  
 KB 501-08 8 mm  
 KB 501-10 10 mm  
 KB 501-12 12 mm  
 18,5 cm, 7 1/4"

Osteotomes, graduated,  
 straight



1/2

**COTTLE**  
 KB 502-02 2 mm  
 KB 502-04 4 mm  
 KB 502-06 6 mm  
 18,5 cm, 7 1/4"

Osteotomes, graduated,  
 curved



1/2

**COTTLE**  
 KB 503-02 2 mm  
 KB 503-04 4 mm  
 KB 503-06 6 mm  
 KB 503-08 8 mm  
 KB 503-10 10 mm  
 KB 503-12 12 mm  
 18,5 cm, 7 1/4"

Chisels, graduated,  
 straight



**COTTLE**  
 KB 504-16 16 mm  
 18,5 cm, 7¼"

Osteotome, graduated,  
 straight



**RUBIN**  
 KB 505-10 10 mm  
 KB 505-12 12 mm  
 KB 505-14 14 mm  
 KB 505-16 16 mm  
 18,5 cm, 7¼"

Osteotomes, straight, with  
 stabilizer



**COTTLE**  
 KB 506-10 10 mm  
 KB 506-12 12 mm  
 KB 506-14 14 mm  
 KB 506-16 16 mm  
 18,5 cm, 7¼"

Osteotomes, graduated, straight



**FOMON (MASING)**  
 21 cm, 8 3/4"

**KB 505-21**

file cut

6 mm

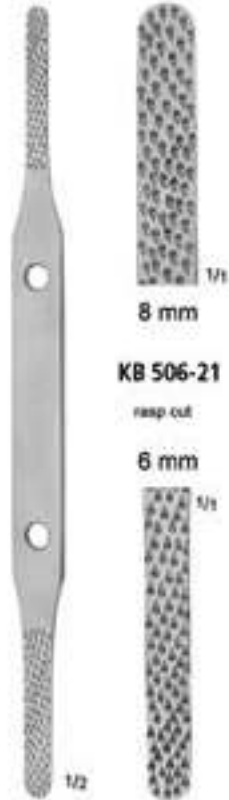

**FOMON (MASING)**  
 21 cm, 8 3/4"

**KB 506-21**

rasp cut

6 mm



**JOSEPH**  
 17 cm, 6 3/4"

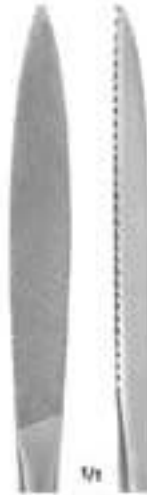

**KB 507-16**  
 8 mm  
 fine

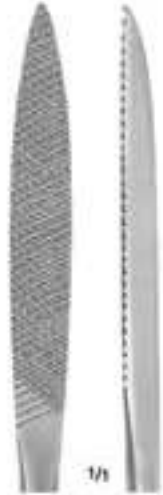

**KB 508-16**  
 8 mm  
 coarse



**MALTZ**  
 18 cm, 7"

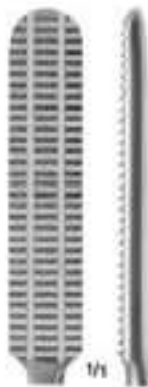

**KB 509-18**  
 9 mm  
 drawing cut



**MALTZ**  
 17 cm, 6 3/4"



**KB 510-18**  
 7 mm  
 drawing cut

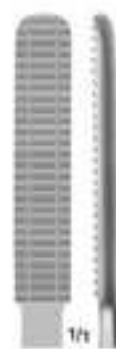

**KB 511-18**  
 7 mm  
 pushing cut

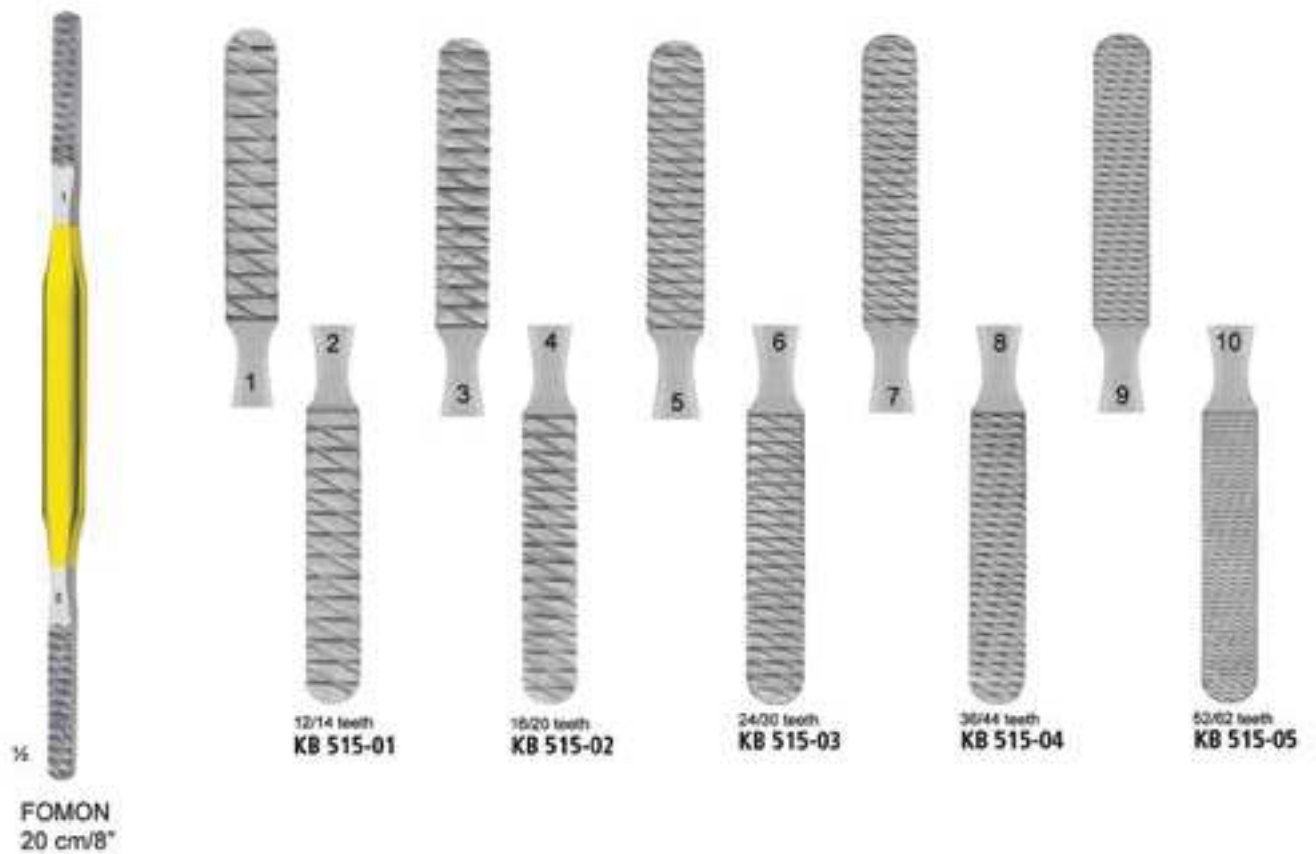
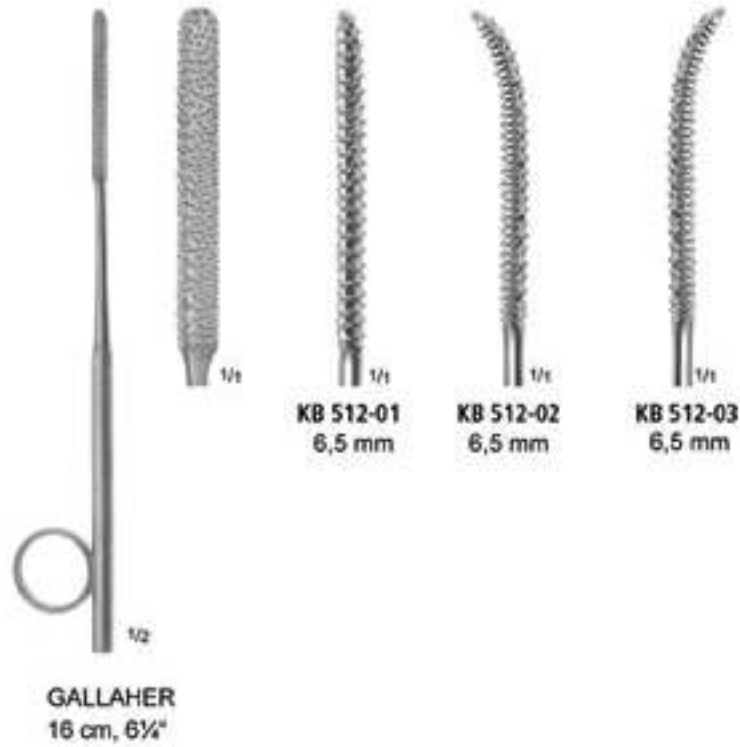



**MILLER**  
 18 cm, 7"



**KB 516-01**



5 mm



**KB 516-02**



4,3 mm

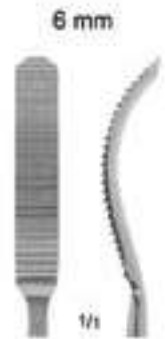

**KB 516-03**



5 mm



**LEWIS**  
 18 cm, 7"



**KB 517-08**  
 8 mm  
 fine, drawing cut



**KB 518-08**  
 8 mm  
 coarse, drawing cut



**KB 519-08**  
 9 mm  
 pushing cut



**KB 520-08**  
 9 mm  
 drawing cut



**AUFRICHT**  
 20,5 cm, 8"  
 Gabelte raspe





**STERNBERG**  
 KB 535-01 12 cm, 4¾"  
 KB 535-02 14 cm, 5½"  
 KB 535-03 16 cm, 6¼"

Lip and cheek retractors



2 x 4 mm

**KB 549-20**  
 20 cm, 8"  
 Suction respiratory and elevator with stylus



**JOSEPH**  
 18,5 cm, 7¼"



1/1



**KB 558-01**  
 straight



**KB 558-02**  
 curved to the right



**KB 558-03**  
 curved to the left

1/1

1/1

1/2

1/2



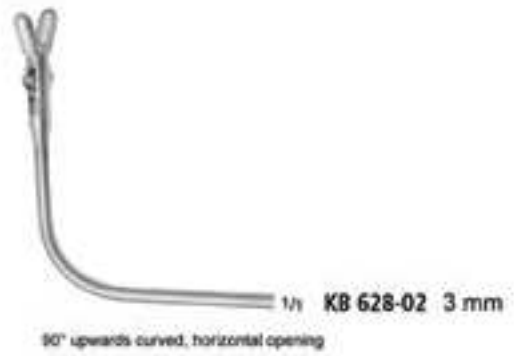
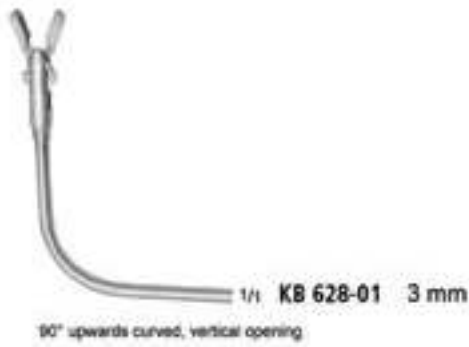
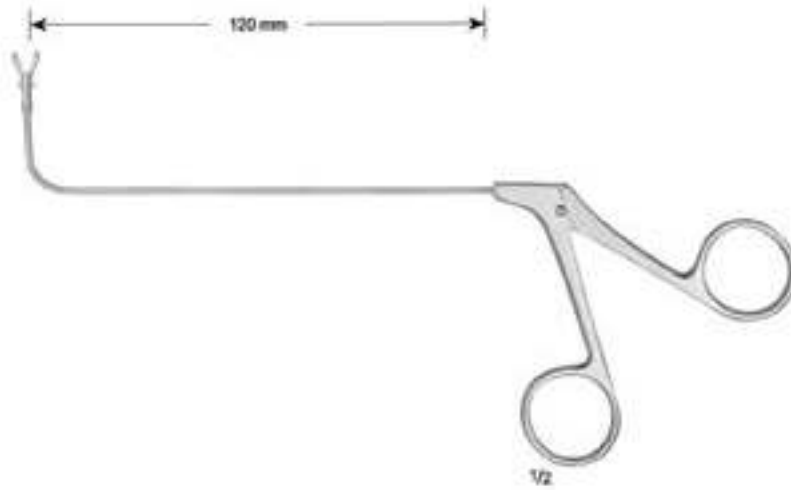

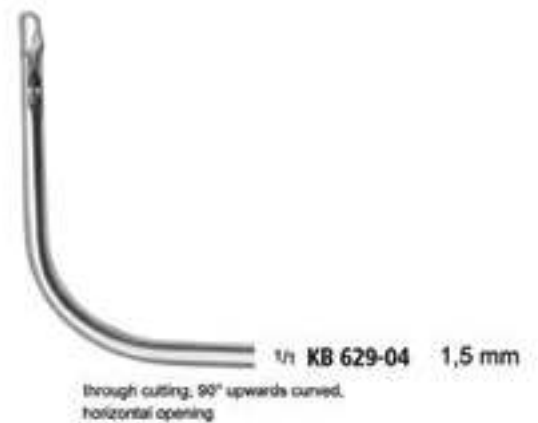
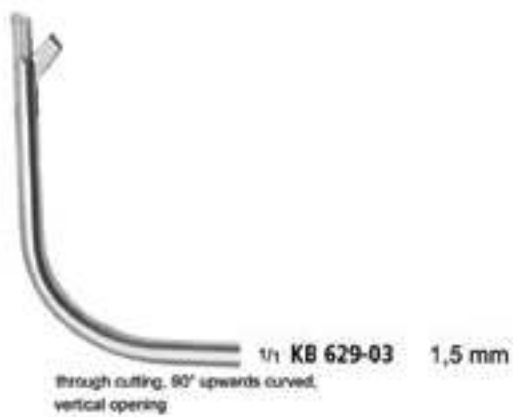
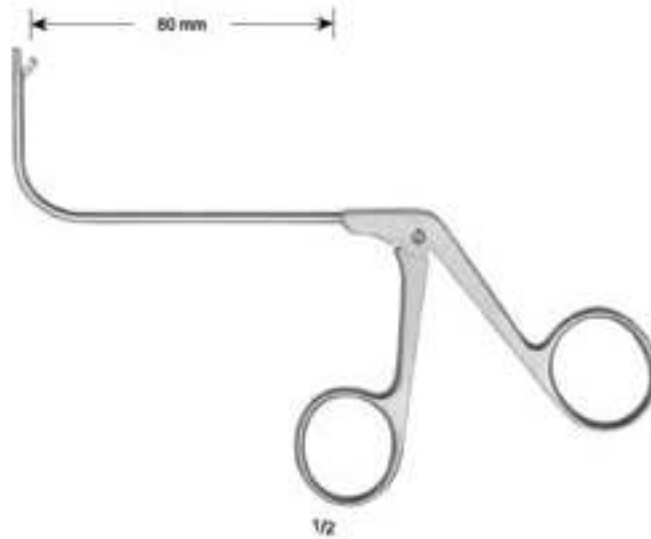



STAMMBERGER



retrograde cutting, up cutting

KB 800-01 2,5 mm



retrograde cutting, cutting right

KB 800-02 2,5 mm



retrograde cutting, cutting left

KB 800-03 2,5 mm

ø 25 mm  
140 g



**KB 900-18**  
18,5 cm, 7¼"

Mallet with interchangeable plastic  
heads

ø 30 mm  
240 g



**COTTLE**  
**KB 902-18**  
19 cm, 7½"

Mallet, 1 side flat,  
1 side convex



METZENBAUM



MA 149-14  
 14,5 cm, 5½"



MA 150-14  
 14,5 cm, 5½"



METZENBAUM



MA 155-11  
 11,5 cm, 4½"



MA 156-11  
 11,5 cm, 4½"



METZENBAUM  
 Standard patterns



MA 200-18  
 18 cm, 7"



MA 201-18  
 18 cm, 7"



BABY-METZENBAUM



MA 210-14  
 14,5 cm, 5½"



MA 211-14  
 14,5 cm, 5½"



**METZENBAUM**  
 delicate patterns



**MA 214-18**  
 18 cm, 7"



**MA 215-18**  
 18 cm, 7"



**MA 219-15**



**15 cm, 6"**  
 Nerve dissecting scissors  
 blades outside semi-  
 sharp



**FOMON**  
 14 cm, 5 1/2"  
 Nasal scissor



**MA 222-13**



**JOSEPH**



**MA 228-14**  
 14 cm, 5 1/2"



**MA 229-14**  
 14 cm, 5 1/2"



**MA 231-12**  
 12,5 cm, 5"

**MA 231-15**  
 15 cm, 6"

**MA 231-18**  
 17,5 cm, 7"

**MA 233-15**  
 14,5 cm, 5 3/4"

**MA 233-18**  
 18 cm, 7"

**KILNER**

**REYNOLDS**  
 blades serrated



**MA 311-19**  
 18,5 cm, 7 1/4"

**MC INDOE**  
 Scissors for cartilage



**MA 354-15**  
 15,5 cm, 6"

**MA 354-18**  
 18 cm, 7"

**JAMESON**







**MA 451-18**

**HEYMANN**  
 17,5 cm, 7"



**MA 452-19**

**HEYMANN**  
 18,5 cm, 7 1/4"  
 1 blade serrated



**MA 543-14**  
 14,5 cm, 5 3/4"

**MA 544-14**  
 14,5 cm, 5 3/4"

**BROPHY (SULLIVAN)**



**MA 561-10**  
 10,5 cm, 4 1/4"

**MA 562-10**  
 10,5 cm, 4 1/4"

**MA 561-11**  
 11,5 cm, 4 1/2"

**MA 562-11**  
 11,5 cm, 4 1/2"



**MA 570-10**

**GRAEFE (WALTER)**  
 10,5 cm, 4½°



**STEVENS**



**MA 573-10**  
 10,5 cm, 4½°



**MA 574-10**  
 10,5 cm, 4½°

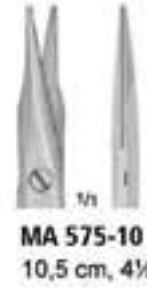

**MA 575-10**  
 10,5 cm, 4½°



**MA 576-10**  
 10,5 cm, 4½°



**MA 577-10**  
 10 cm, 4°

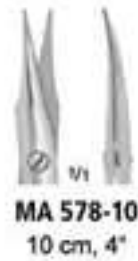

**MA 578-10**  
 10 cm, 4°



**MA 579-10**  
 10 cm, 4°



**MA 580-10**  
 10 cm, 4°

**STEVENS**  
 with flat shanks and  
 large ergonomical rings

**STEVENS**  
 with flat shanks and  
 large ergonomical rings



MA 601-12

**HARVEY**  
 12,5 cm, 5"  
 Wire cutting scissors,  
 1 blade serrated



MA 604-12

**UNIVERSAL**  
 12 cm, 4 3/4"  
 Wire cutting scissors,  
 1 blade serrated



**GOLDMANN-FOX**  
 1 blade serrated



MA 710-13  
 13 cm, 5 1/4"



MA 711-13  
 13 cm, 5 1/4"



MA 721-11  
 11 cm, 4 3/4"



MA 722-11  
 11 cm, 4 3/4"



**SEALY**

Hard Metal Edged



**METZENBAUM**



**MA 865-11**  
 11,5 cm, 4½"



**MA 866-11**  
 11,5 cm, 4½"



**METZENBAUM**



**MA 867-14**  
 14,5 cm, 5¾"



**MA 875-14**  
 14,5 cm, 5¾"



**MA 877-14**  
 14,5 cm, 5¾"



**MA 868-14**  
 14,5 cm, 5¾"  
 Standard patterns



**MA 876-14**  
 14,5 cm, 5¾"  
 delicate patterns



**MA 878-14**  
 14,5 cm, 5¾"  
 very delicate patterns

Hard Metal Edged



**METZENBAUM**



**MA 869-18**  
18 cm, 7"



**MA 879-18**  
18 cm, 7"



**MA 881-18**  
18 cm, 7"



**MA 870-18**  
18 cm, 7"  
Standard patterns



**MA 880-18**  
18 cm, 7"  
delicate patterns



**MA 882-18**  
18 cm, 7"  
very delicate patterns



**Hard Metal Edged**



**GOLDMANN-FOX**



**MA 884-13**  
 13 cm, 5 1/4"



**MA 885-13**  
 13 cm, 5 1/4"



**MA 886-11**  
 11,5 cm, 4 1/2"



**MA 887-11**  
 11,5 cm, 4 1/2"



**JOSEPH**



**MA 886-14**  
 14 cm, 5 1/2"



**MA 887-14**  
 14 cm, 5 1/2"



**UNIVERSAL**  
 12 cm/4 3/4"



**MA 889-12**  
 One toothed cutting edge



**SUPER CUT**

Hard Metal Edged



BABY-METZENBAUM



MA 891-11  
11,5 cm, 4½"



MA 892-11  
11,5 cm, 4½"



METZENBAUM



MA 891-14  
14,5 cm, 5¾"



MA 892-14  
14,5 cm, 5¾"



METZENBAUM



MA 891-18  
18 cm, 7"



MA 892-18  
18 cm, 7"

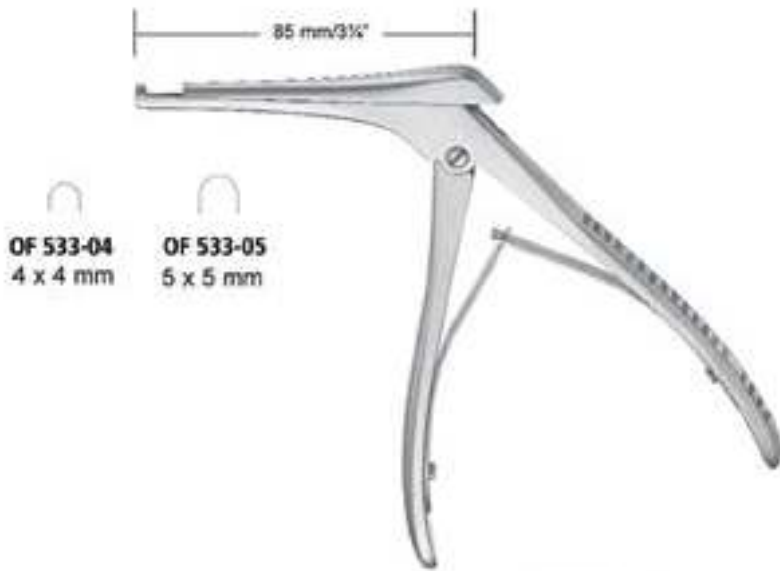

**KERRISON**  
 17 cm/6 3/4"



**CITELLI**  
 2,5 mm OF 534-02  
 4,0 mm OF 534-04



**BEYER**

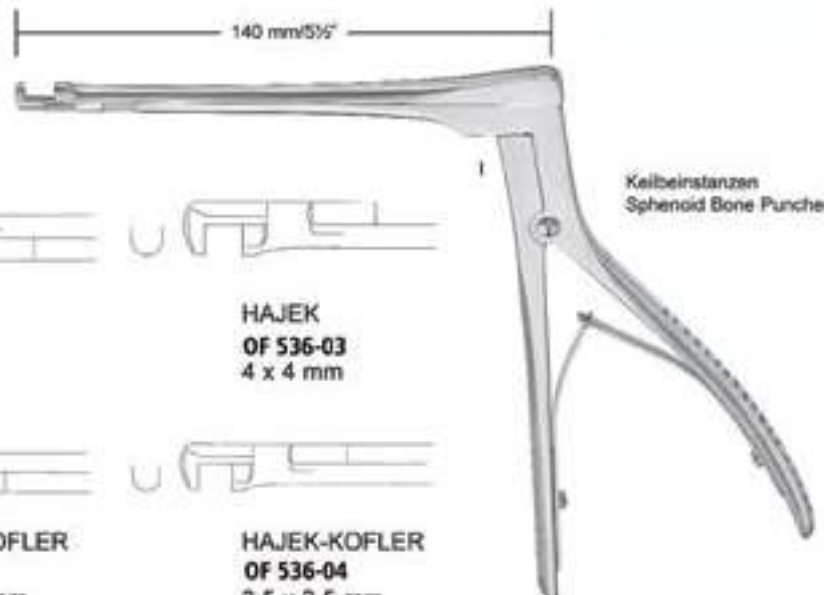

**HAJEK**  
 OF 536-01  
 4 x 4 mm

**HAJEK**  
 OF 536-03  
 4 x 4 mm

**HAJEK-KOFLER**  
 OF 536-02  
 3,5 x 3,5 mm

**HAJEK-KOFLER**  
 OF 536-04  
 3,5 x 3,5 mm

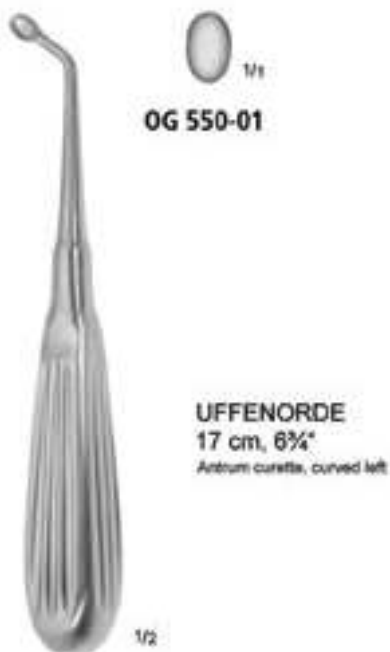

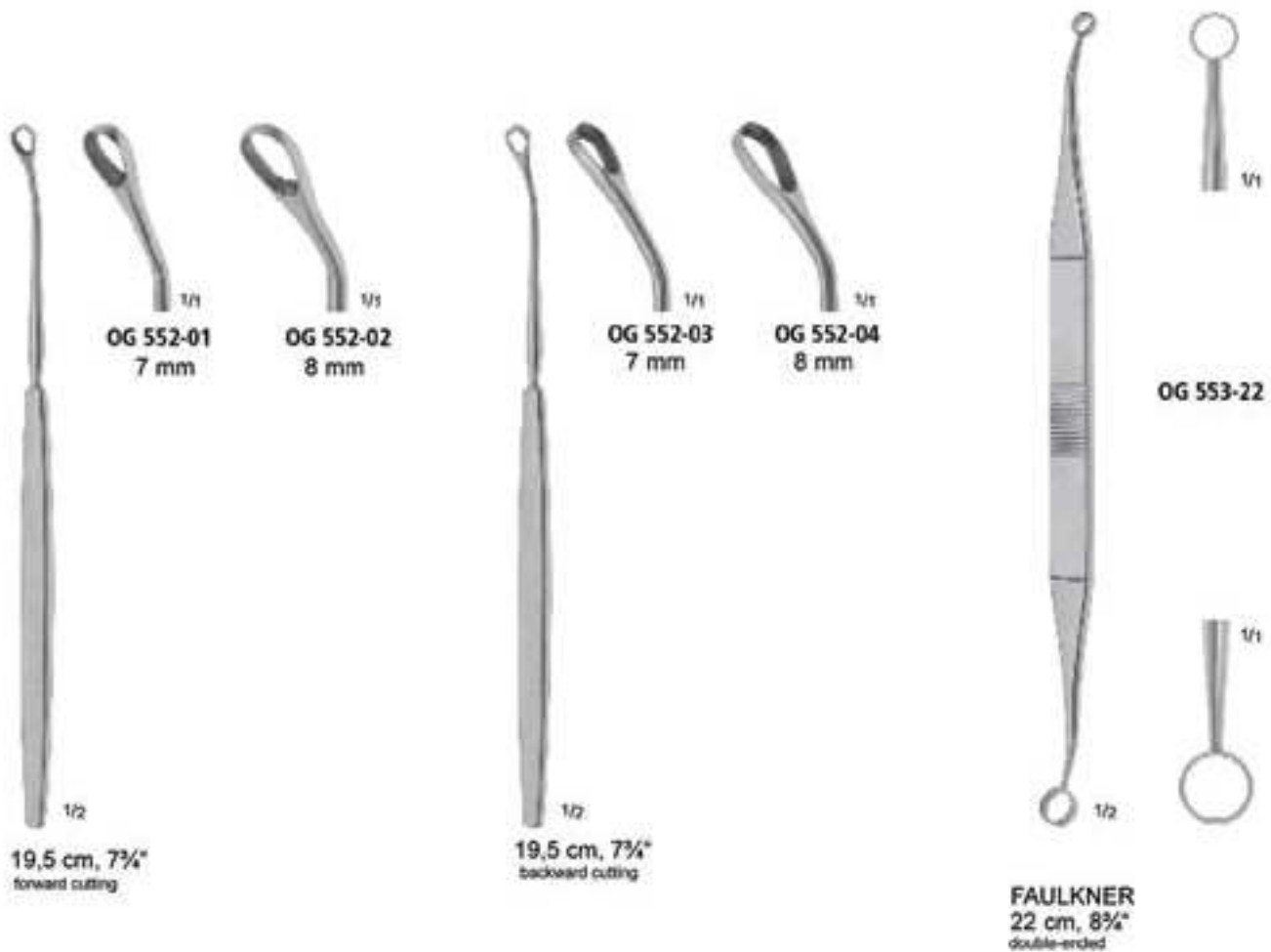

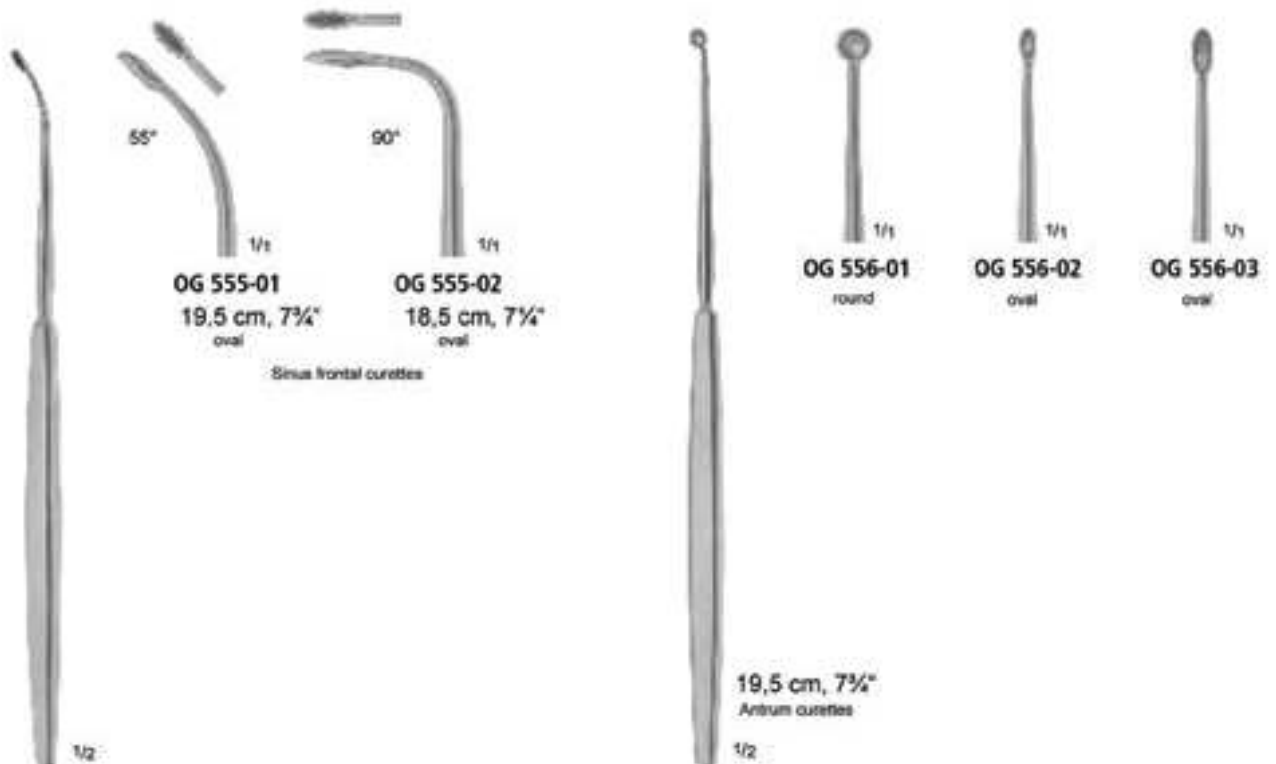
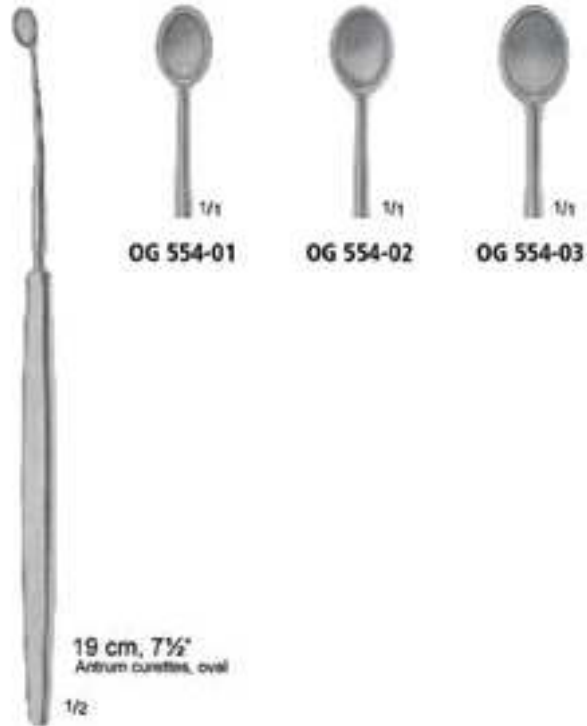



**RUSKIN-LISTON**  
**OM 362-19**  
18,5 cm, 7¼"



**RUSKIN-LISTON**  
**OM 363-19**  
18,5 cm, 7¼"



**MC INDOE**  
**OM 363-17**  
17,5 cm, 7"

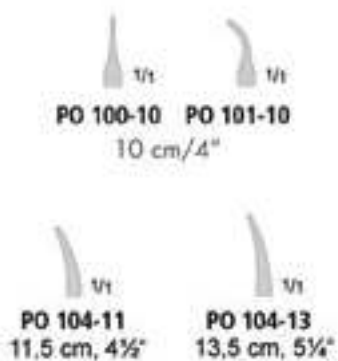

**BARRAQUER-TROUTMAN**  
 with catch

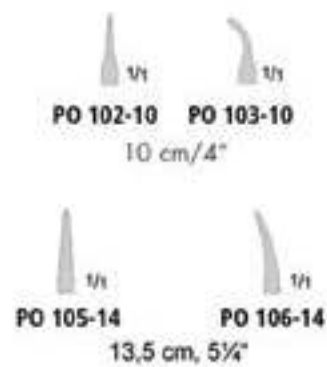

**BARRAQUER**  
 without catch

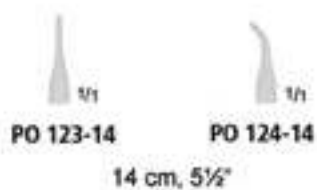

**CASTROVIEJO**  
 without catch

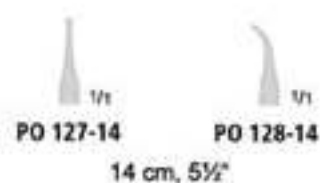

**CASTROVIEJO**  
 14 cm/5 1/2 inch



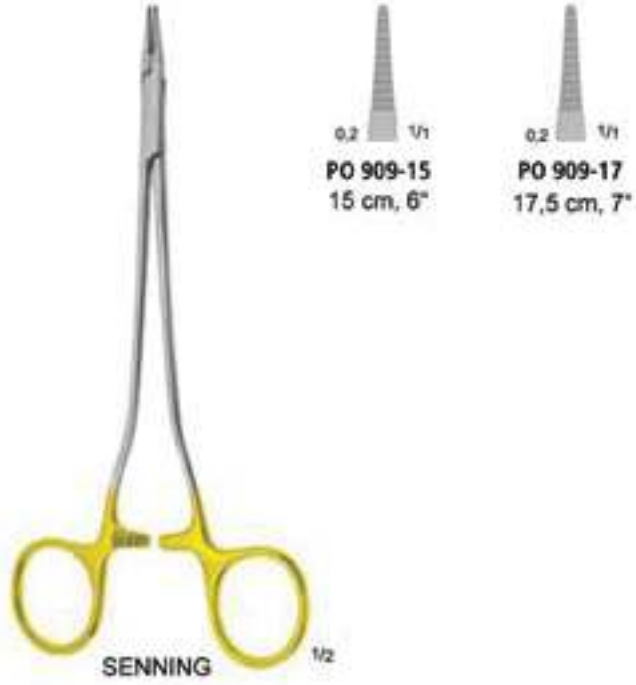



PO 919-15  
15 cm/6"

CRILE WOOD



PO 924-12  
12 cm/4 3/4"

OLSEN HEGAR



PO 924-14  
13,5 cm, 5 1/4"

OLSEN HEGAR



PO 925-16  
16 cm/6 1/4"

GILLIES





CASTROVIEJO



smooth jaw

14,5 cm/5¾" PO 950-14 PO 951-14 PO 952-14 PO 953-14

with catch



**FARRELL**  
16 cm, 6 1/4" SO 211-16  
18 cm, 7" SO 211-18  
Cotton applicators, spiral serrated



**FARRELL**  
16 cm, 6 1/4" SO 212-16  
18 cm, 7" SO 212-18  
Cotton applicators, triangular serrated



**Tonsilektomi - Larengoloji -Traketomi**  
**Tonsillectomy - Laryngology - Tracheotomy**  
**Tonsillektomie - Laryngologie - Tracheotomie**

Tonsilektomi - Larengoloji - Traketomi  
Tonsillectomy - Laryngology - Tracheotomy  
Tonsillektomie - Laryngologie - Tracheotomie

**iDOL**  
CERRAHİ ALETLER  
www.idolcerrahi.com

Ø mm	19 cm/7 1/2"
ø 1,5 mm	AS 120-15
ø 2,0 mm	AS 120-20
ø 2,5 mm	AS 120-25
ø 3,0 mm	AS 120-30
ø 4,0 mm	AS 120-40
ø 5,0 mm	AS 120-50



FRAZIER



DE BAKEY  
AS-352-27  
28 cm/11"



YANKAUER  
AS-355-27  
27 cm/10 1/4"

Tonsilektomi - Larengoloji - Traketomi  
Tonsillectomy - Laryngology - Tracheotomy  
Tonsillektomie - Laryngologie - Tracheotomie

**iDOL**  
CERRAHİ ALETLER  
[www.idolcerrahi.com](http://www.idolcerrahi.com)



massiv, mit Zentimeter  
solid, cm

**BS 200-03**  
12 cm/4¾"  
No. 3



**BS 201-03**  
12 cm/4¾"  
Fig. 3



**BS 202-13**  
21,5 cm/8½"  
Fig. 3 L



**BS 210-07**  
16 cm/6¼"  
Fig. 7





1/2

**CANFIELD**  
BS 520-01  
21,5 cm, 8½"



1/2

**ABRAHAM**  
BS 520-02  
22 cm, 8½"



1/2

**BRUENINGS**  
BS 520-03  
23 cm, 9"



1/2

**FISCHER**  
BS 520-04  
23 cm, 9"

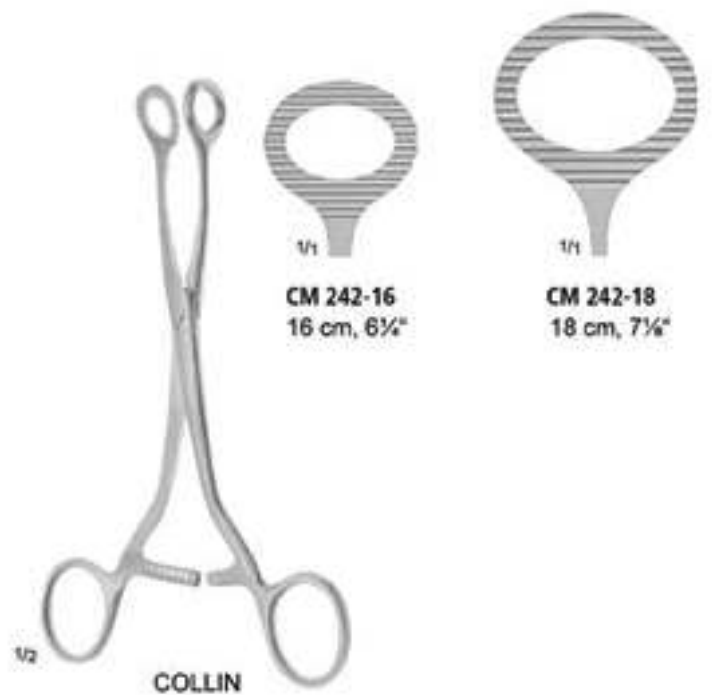
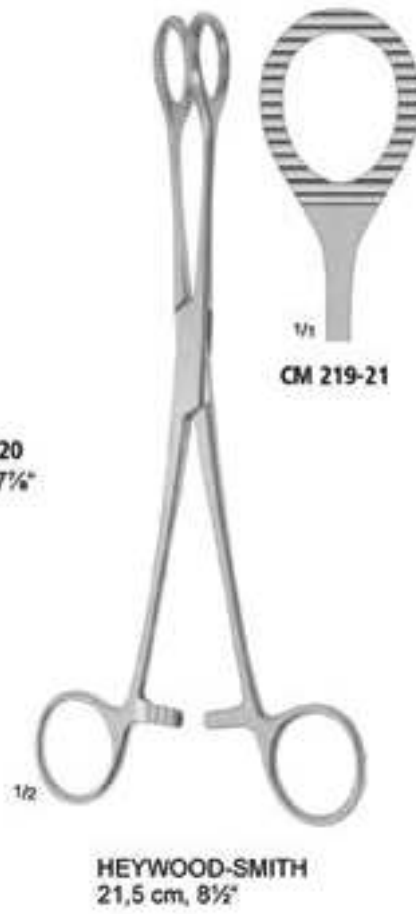



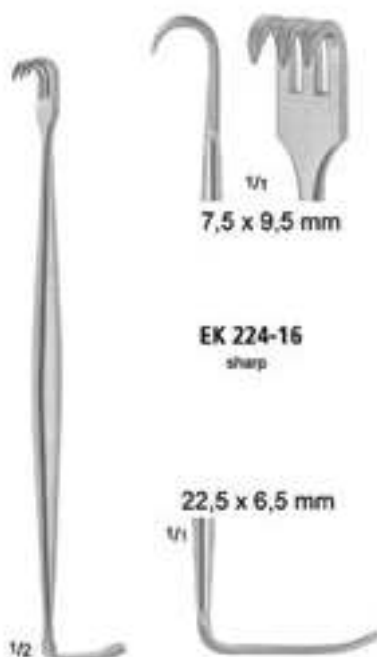

**EK 224-16**  
sharp



**EK 225-16**  
blunt



**1/1**  
10 x 12 mm

**EK 226-17**

7 x 14 mm

**SENN-MILLER**  
Retractors, double-ended  
16 cm, 6 1/4"

**LUKENS**  
17,5 cm, 6 3/4"

Tonsilektomi - Larengoloji - Traketomi  
 Tonsillectomy - Laryngology - Tracheotomy  
 Tonsillektomie - Laryngologie - Tracheotomie



**VOLKMANN**  
 22,5 cm, 8<sup>3</sup>/<sub>4</sub>"



sharp



blunt

**EK 229-02**  
 10 x 8 mm



**EK 229-03**  
 10 x 13 mm



**EK 229-04**  
 10 x 18 mm



**EK 229-06**  
 10 x 28 mm



sharp



blunt

**EK 231-02**  
 10 x 8 mm



**EK 231-03**  
 10 x 13 mm



**EK 231-04**  
 10 x 18 mm



**EK 231-06**  
 10 x 28 mm



**LAHEY**  
 19,5 cm, 7<sup>3</sup>/<sub>4</sub>"



**EK 265-19**  
 25 x 6 mm  
 Goibe retractor



**SCHOENBORN**  
 21 cm, 8<sup>1</sup>/<sub>2</sub>"



**EK 265-21**  
 6 x 13 mm



**EK 352-02**  
 21 cm/8¼"



**EK 352-01**  
 22 cm/8½"

1/2  
**LANGENBECK**



1/2  
**LANGENBECK**  
 22 cm/8½"



**EK 353-01**  
 30 x 11 mm



**EK 353-02**  
 30 x 16 mm



**EK 353-03**  
 30 x 14 mm

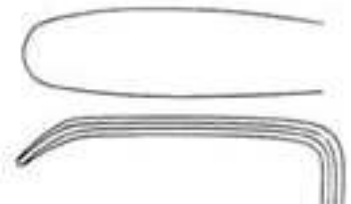

**EK 353-04**  
 40 x 11 mm



1/2  
**KOCHER-LANGENBECK**  
 22 cm/8½"







1/2

**MIDDELDORF**



**EK 369-17**  
 15 x 16 mm  
 21,5 cm, 8 1/2"

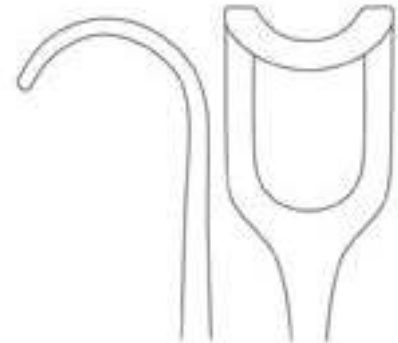

**EK 369-22**  
 20 x 22 mm  
 22,5 cm, 8 3/4"

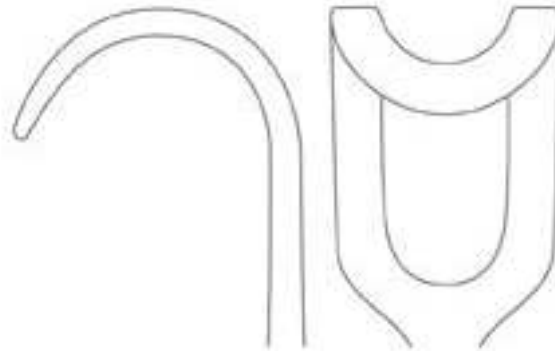

**EK 369-26**  
 26 x 30 mm  
 24,0 cm, 9 1/2"



24 x 21 mm

28 x 29 mm

1/2

**ROUX**  
**EK 396-01**  
 14,5 cm, 5 3/4"



18 x 17 mm

24 x 21 mm

1/2

**BABY-ROUX**  
**EK 398-01**  
 12,5 cm, 4 3/4"



1/2

**ROSE**  
**EK 403-02**  
 13 cm, 5 1/4"

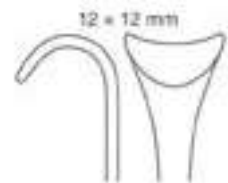

12 x 12 mm



12 x 10 mm



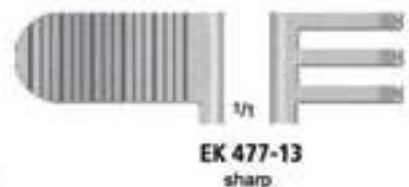

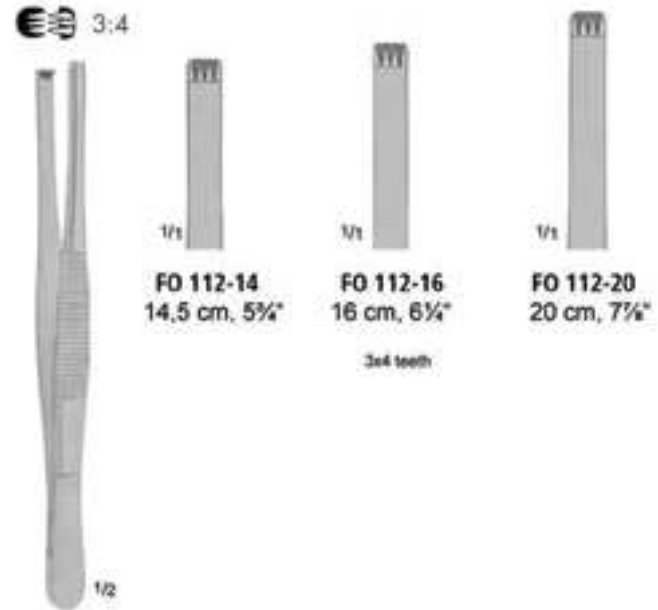
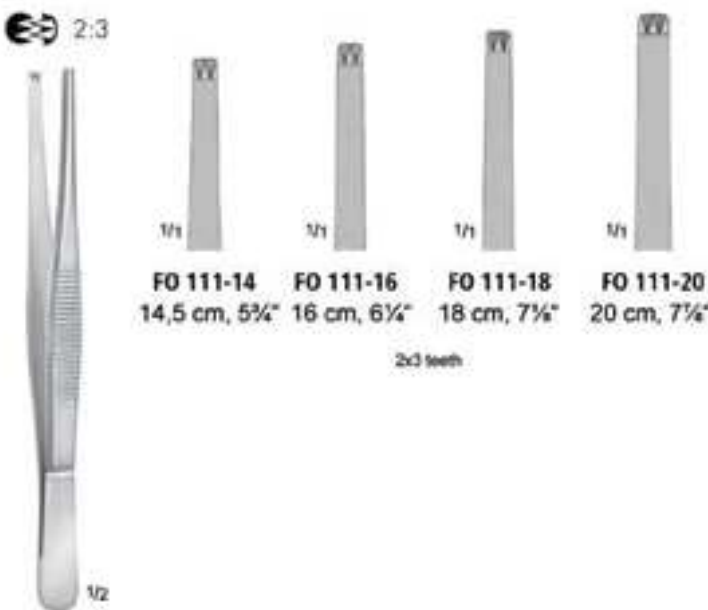
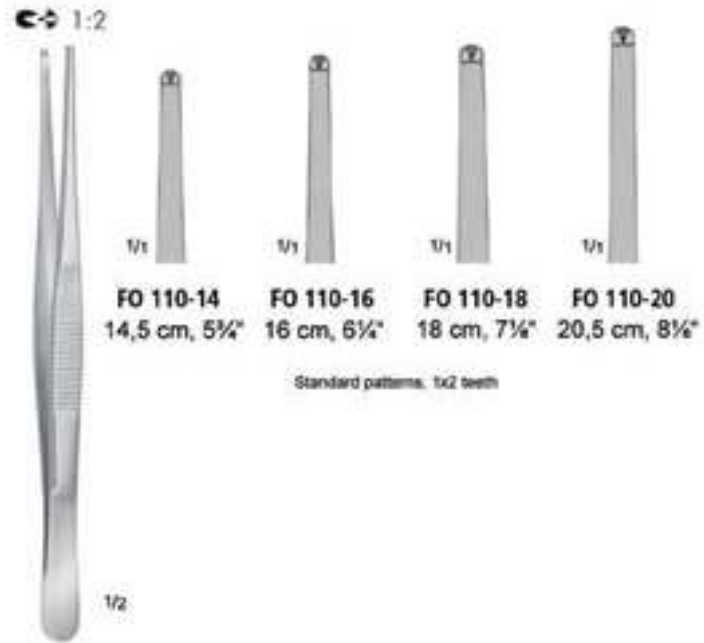
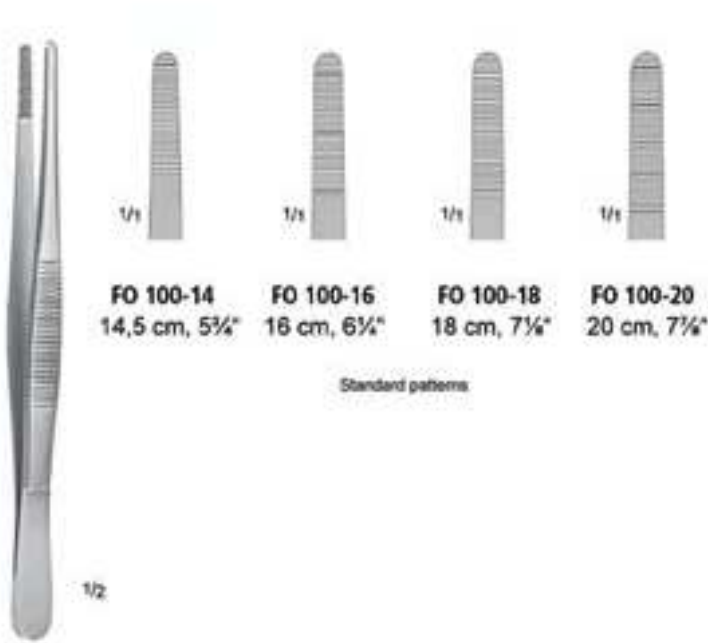

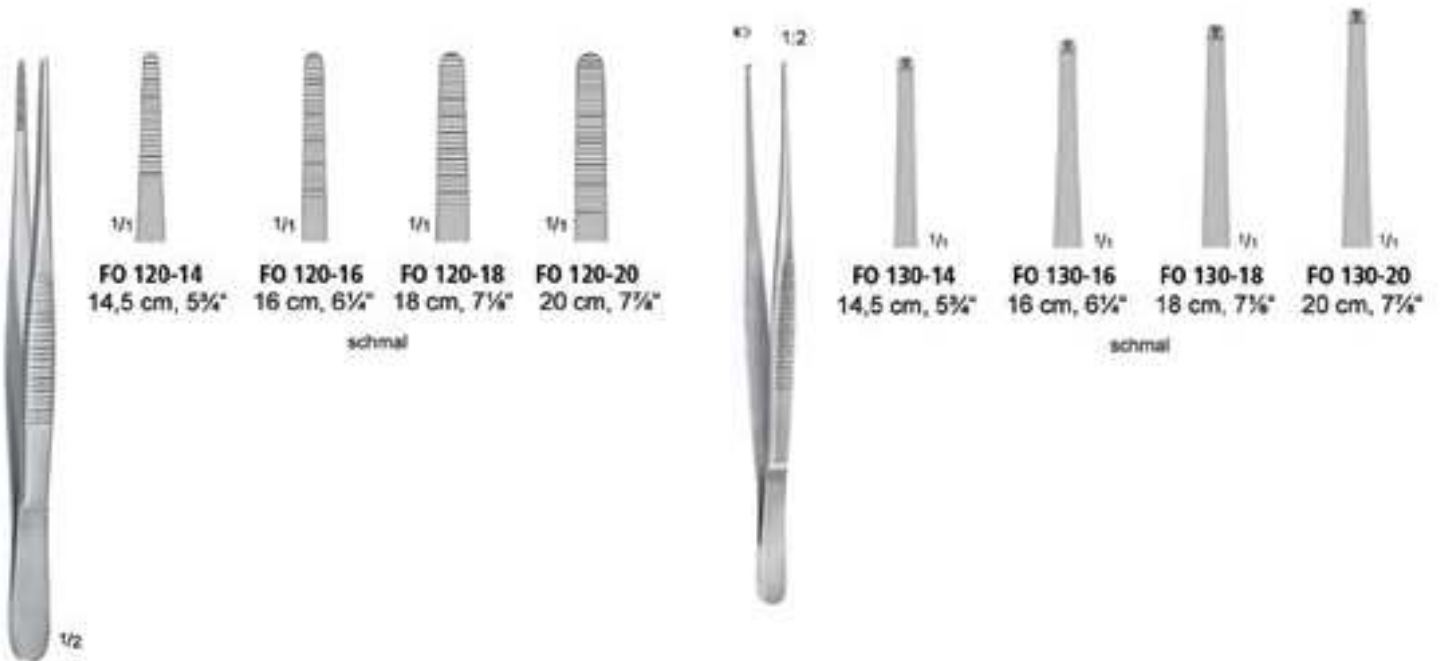

**Tonsilektomi - Larengoloji - Traketomi**  
**Tonsillectomy - Laryngology - Tracheotomy**  
**Tonsillektomie - Laryngologie - Tracheotomie**

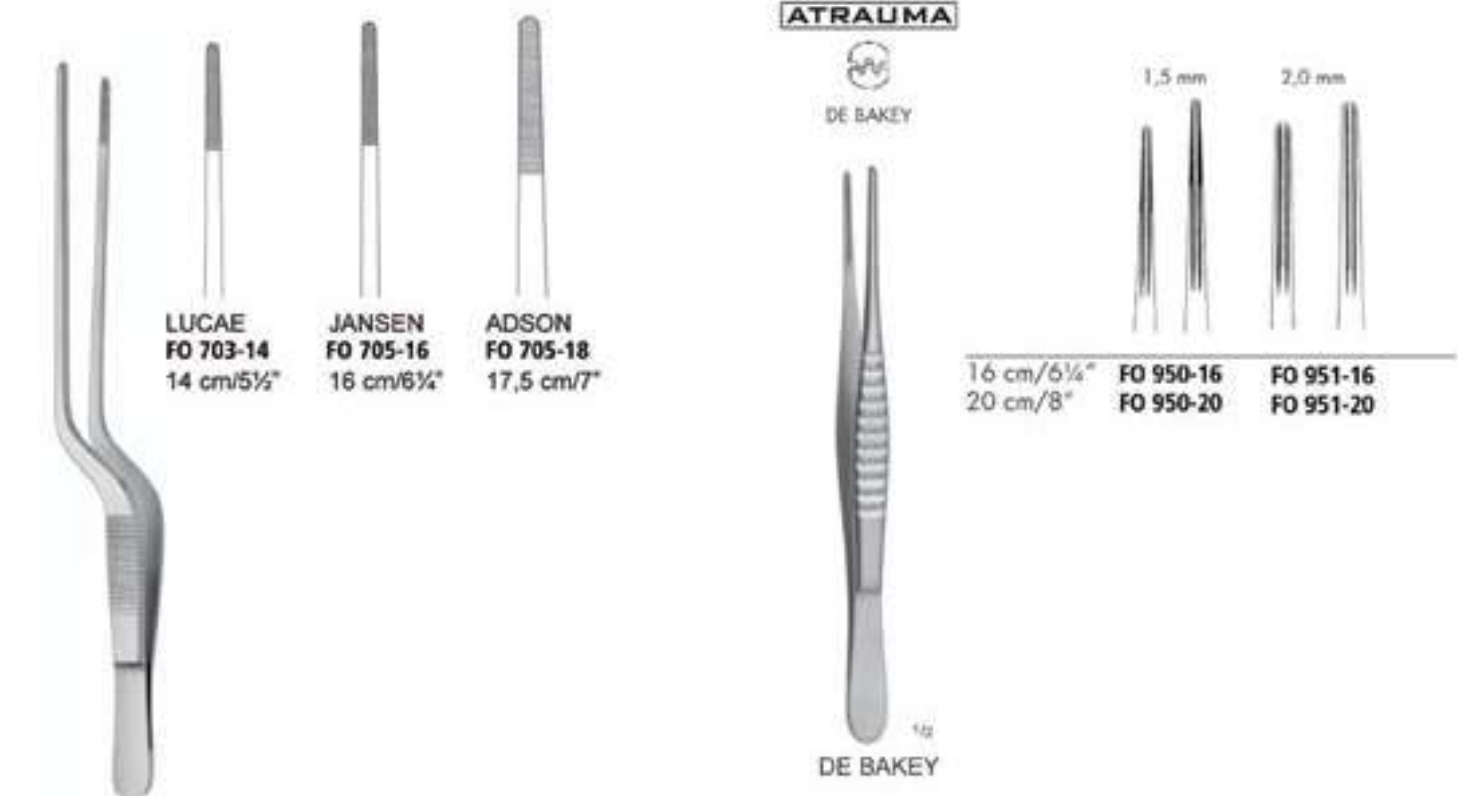
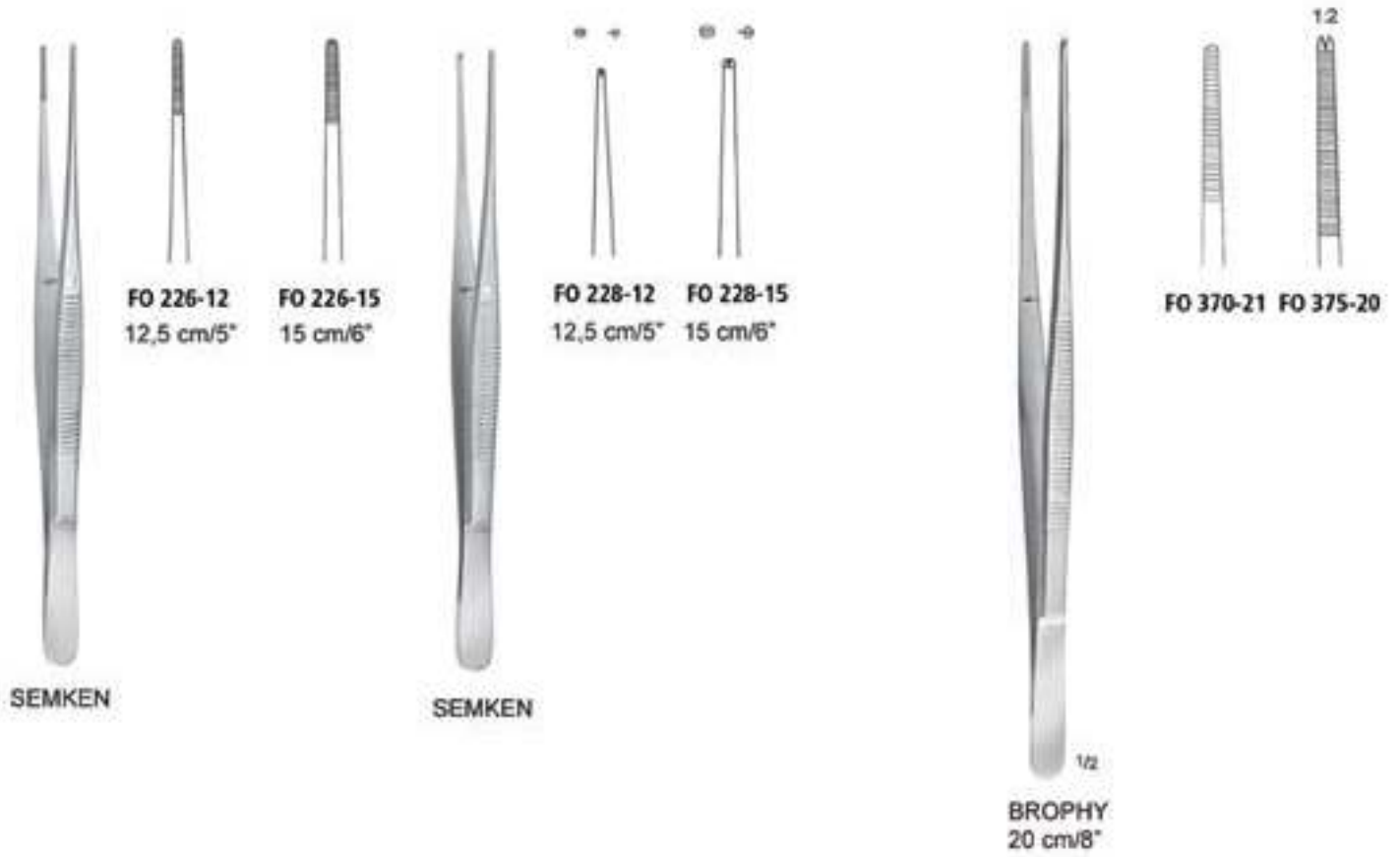

Tonsilektomi - Larengoloji - Traketomi  
 Tonsillectomy - Laryngology - Tracheotomy  
 Tonsillektomie - Laryngologie - Tracheotomie

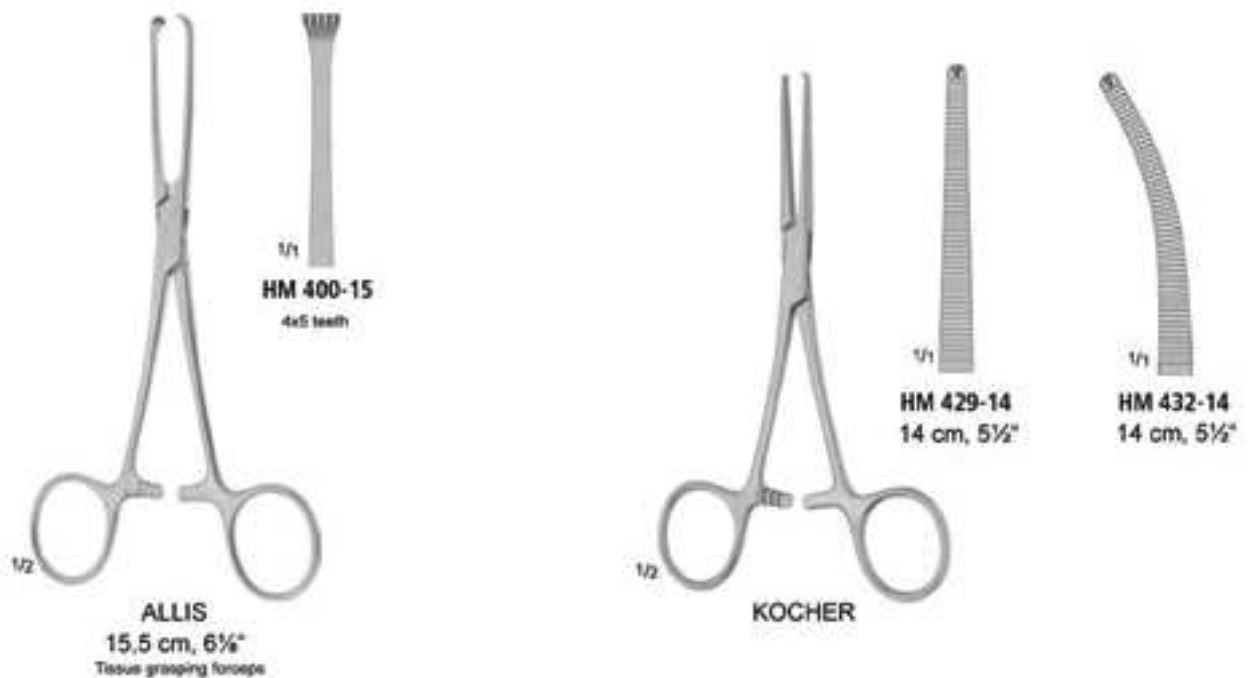
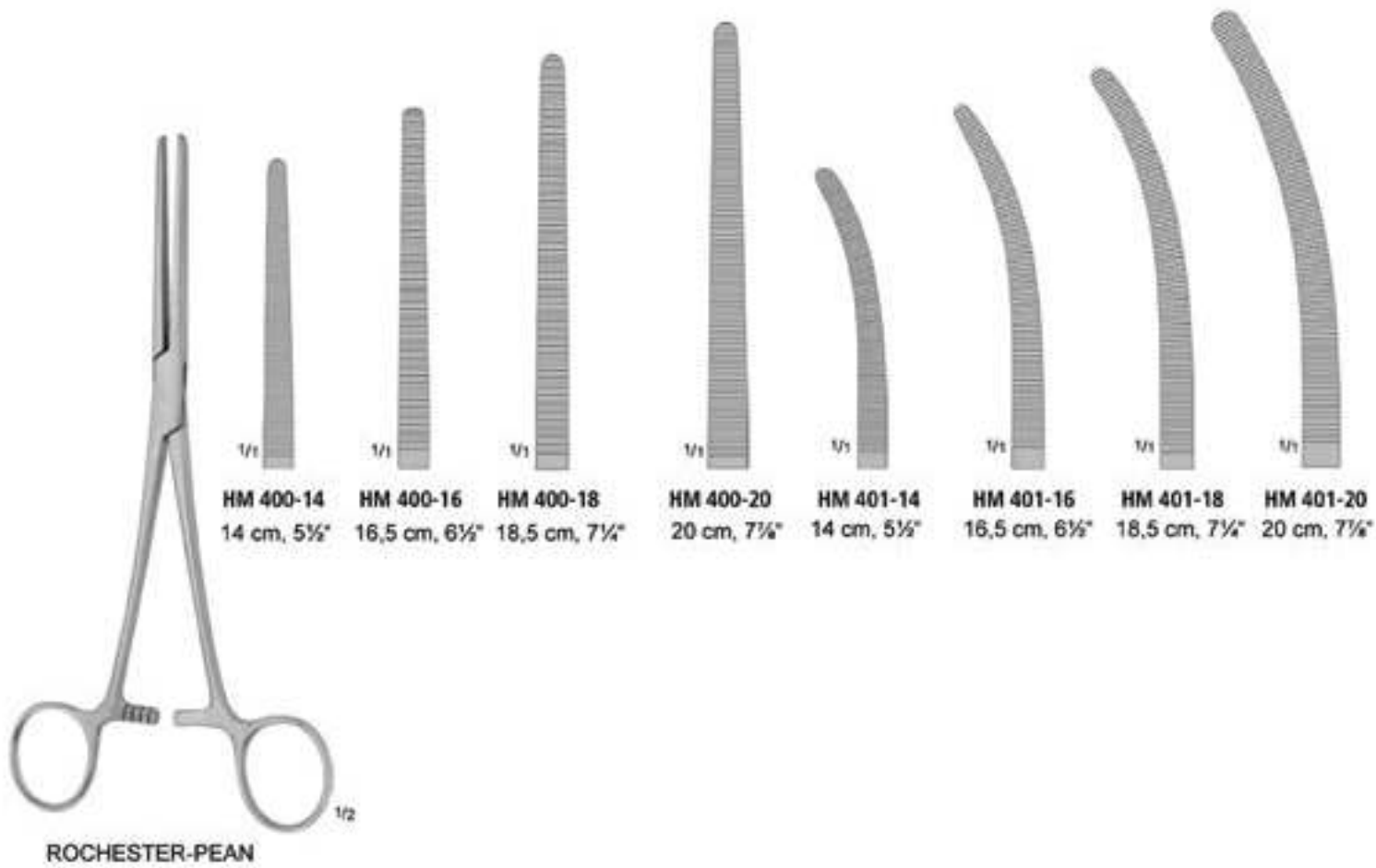

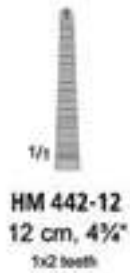
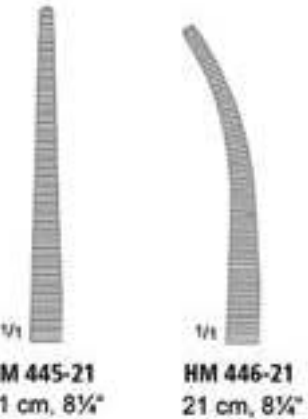
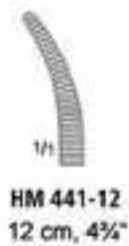
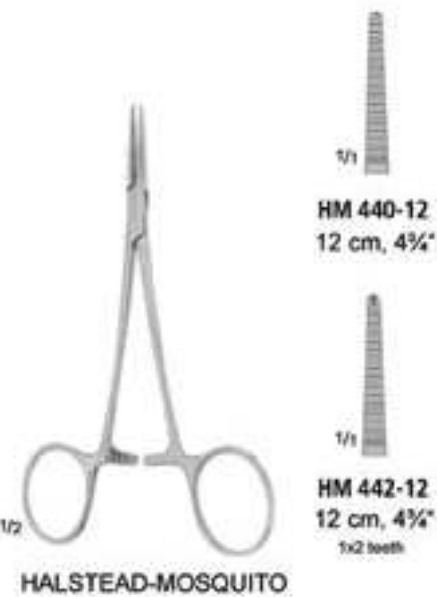





HM 550-01  
 19,5 cm, 7 $\frac{1}{4}$ "

HM 550-02  
 19,5 cm, 7 $\frac{1}{4}$ "



HM 701-18  
 1x2 teeth



HM 704-20  
 1x2 teeth



HM 860-08  
 9 cm, 3 $\frac{1}{2}$ "

HM 860-11  
 11 cm, 4 $\frac{1}{4}$ "

HM 860-13  
 13,5 cm, 5 $\frac{1}{4}$ "



Tonsilektomi - Larengoloji - Traketomi  
Tonsillectomy - Laryngology - Tracheotomy  
Tonsillektomie - Laryngologie - Tracheotomie

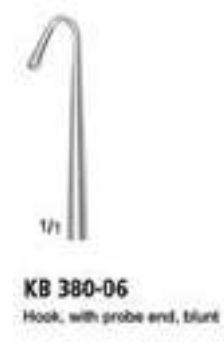
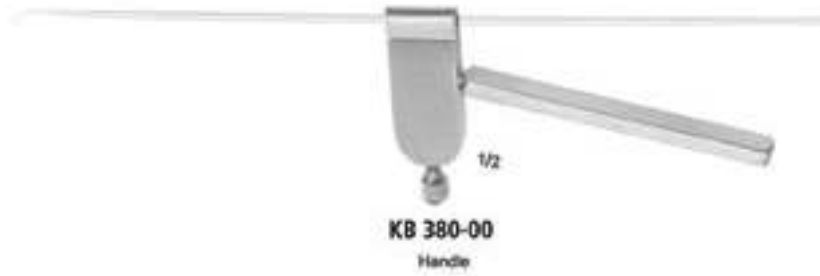

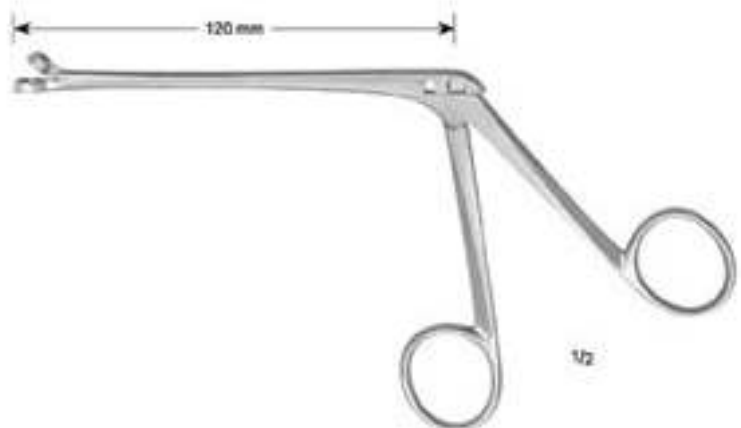
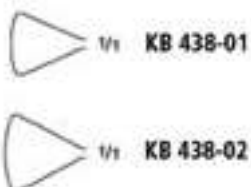
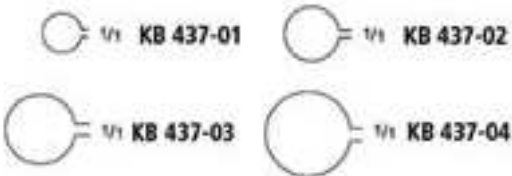
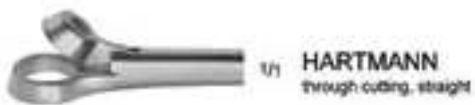



$\frac{1}{2}$   
**MORITZ-SCHMIDT**  
 19,5 cm, 7 $\frac{1}{4}$ "

$\frac{1}{4}$   
**KB 524-19**  
 21 mm



$\frac{1}{2}$   
**HARTMANN**  
**KB 525-15**  
 15,5 cm, 6 $\frac{1}{4}$ "

24 x 63 mm



$\frac{1}{2}$   
**TOBOLD**  
**KB 526-16**  
 14,5 cm, 5 $\frac{1}{4}$ "

24 x 83 mm



$\frac{1}{2}$   
**KB 527-01**  
 14,5 cm, 5 $\frac{3}{4}$ "

16 mm

16 mm



$\frac{1}{2}$   
**KB 527-02**  
 14 cm, 5 $\frac{1}{2}$ "

20 mm

23 mm



$\frac{1}{2}$   
**MAYO**  
**KB 527-03**  
 16 cm, 6 $\frac{1}{4}$ "

16 mm

22 mm



$\frac{1}{2}$   
**BUCHWALD**  
**KB 527-04**  
 18 cm, 7 $\frac{1}{4}$ "

19 mm

22 mm



**FRENZEL**  
KB 528-01  
16,5 cm, 6½"



**BRUENINGS**  
KB 528-02  
19 cm, 7½"



**WIEDER**  
30 x 90 mm KB 528-15  
35 x 90 mm KB 529-15  
14,5 cm, 5½"

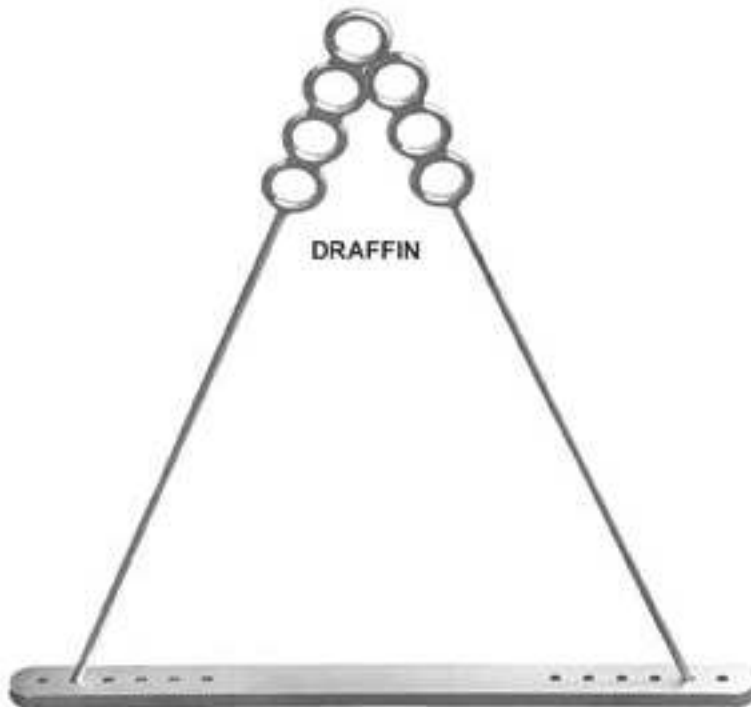

**MAGAURAN**  
KB 530-00  
47 cm, 18½"



1/2  
**DAVIS-MEYER**  
**KB 531-00**  
Frame (handle)



1/2  
**DAVIS-MEYER**  
**KB 531-01**  
Palato blade, for toothless



1/2  
**KILNER-DOUGHTY**  
**KB 532-00**  
Frame (handle), with 2 adjustable tooth plates,  
exchangeable, and 1 palatal support for toothless



1/2  
**DAVIS-BOYLE**  
**KB 533-00**  
Frame (handle), for children



1/2  
**DAVIS-BOYLE**  
**KB 533-01**  
Frame (handle), for adults



1/2

**McIVOR**  
**KB 533-02**  
Frame (handle)



1/2

**DINGMANN**  
**KB 534-00**  
Frame (handle)



**KB 530-29**  
29 X 67 mm

**KB 530-33**  
33 X 75 mm

**KB 530-38**  
38 X 85 mm

**KB 530-40**  
40 X 92 mm

1/2

**KB 530-46**  
46 X 100 mm

**RUSSEL-DAVIS**  
Tongue depressors



Tonsilektomi - Larengoloji - Traketomi  
 Tonsillectomy - Laryngology - Tracheotomy  
 Tonsillektomie - Laryngologie - Tracheotomie



**RUSSEL-DAVIS**  
 Tongue depressors



**DAVIS-MEYER**  
 KB 532-01 29 x 70 mm  
 KB 532-02 30 x 75 mm  
 KB 532-03 31 x 80 mm  
 KB 532-04 32 x 85 mm  
 KB 532-05 33 x 95 mm  
 KB 532-06 33 x 100 mm  
 KB 532-07 34 x 105 mm  
 Tongue depressors,  
 with anesthesia channel on both sides.



**McIVOR**  
 KB 533-01 23 x 70 mm  
 KB 533-02 25 x 86 mm  
 KB 533-03 26 x 100 mm  
 Tongue depressors.



**DAVIS-BOYLE**  
 KB 533-23 23 x 65 mm  
 KB 533-24 24 x 80 mm  
 KB 533-25 25 x 93 mm  
 KB 533-26 26 x 108 mm  
 Tongue depressors,  
 with anesthesia channel.



**DINGMANN**  
 KB 534-25 25 x 65 mm  
 KB 534-29 29 x 70 mm  
 KB 534-32 32 x 80 mm  
 Tongue depressors,  
 with groove for endotracheal tubes.





1/2

**STERNBERG**

KB 535-01 12 cm, 4 $\frac{1}{4}$ "  
KB 535-02 14 cm, 5 $\frac{1}{2}$ "  
KB 535-03 16 cm, 6 $\frac{1}{4}$ "

Lip and cheek retractors



1/2

**HEISTER**  
KB 536-00

13 cm, 5 $\frac{1}{4}$ "



1/2

**MOLT**  
KB 537-01

10 cm, 3 $\frac{3}{4}$ "



1/2

**DOYEN-JANSEN**  
KB 537-02

14 cm, 5 $\frac{1}{2}$ "  
soft metal coated



1/2

**DENHARDT**  
KB 538-12

12.5 cm, 4 $\frac{3}{4}$ "



1/2

**ROSER-KÖNIG**  
KB 538-16 16,0 cm, 6 $\frac{1}{4}$ "  
KB 538-18 18,5 cm, 7 $\frac{1}{4}$ "



**WHITEHEAD**

KB 539-01	9 cm, 3½"
KB 539-02	11 cm, 4¾"
KB 539-03	13 cm, 5¼"
KB 539-04	15 cm, 5¾"

without tongue depressor



**WHITEHEAD**

KB 539-05	11 cm, 4¾"
KB 539-06	13 cm, 5¼"
KB 539-07	15 cm, 5¾"

with tongue depressor



**JENNINGS**

KB 539-08	9 cm, 3½"
KB 539-09	11 cm, 4¾"
KB 539-10	13 cm, 5¼"
KB 539-11	15 cm, 5¾"

without tongue depressor

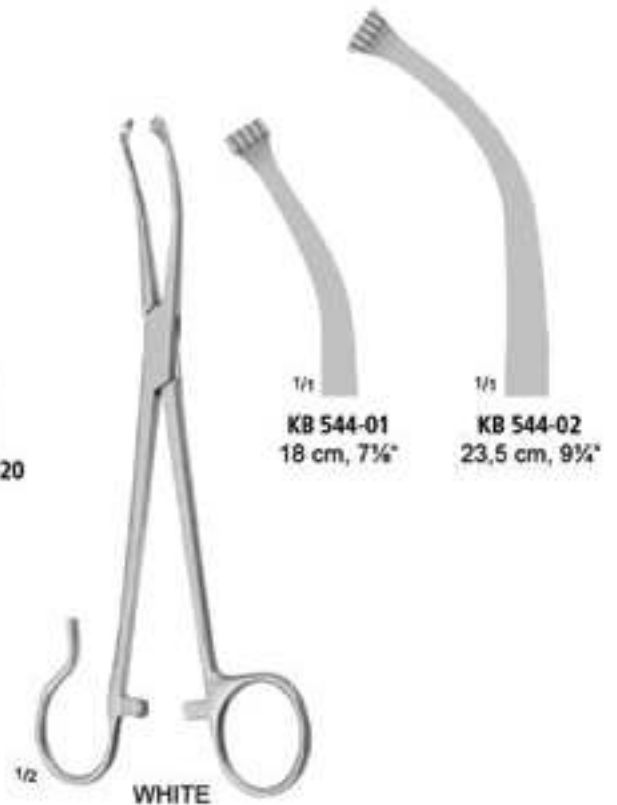
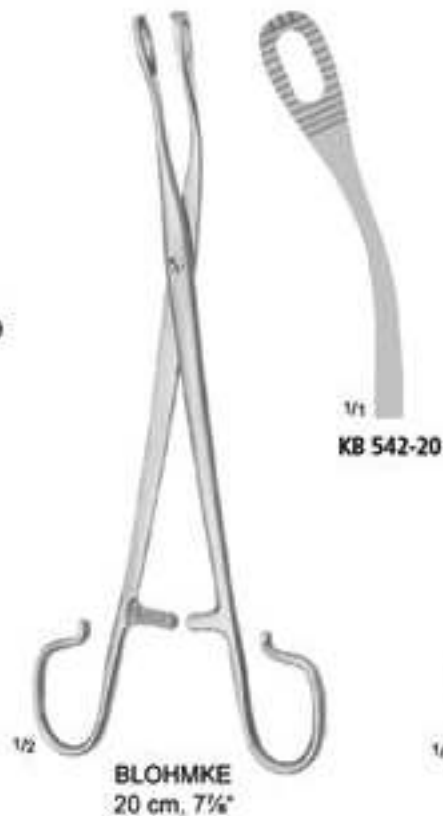



**LOPEZ-REINKE**  
 KB 550-23  
 23,5 cm, 9¼"  
 with suction device



14 mm  
**HURD**  
 KB 551-21  
 22 cm, 8½"



14 mm  
**HURD**  
 KB 552-21  
 22 cm, 8½"



12 mm  
**HENKE**  
 KB 553-23  
 23,5 cm, 9¼"

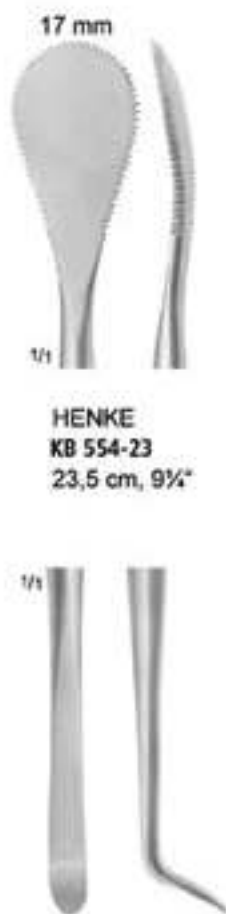

17 mm  
**HENKE**  
 KB 554-23  
 23,5 cm, 9¼"



**GWYNNE EVANS**  
 KB 555-06  
 21,5 cm, 8½"

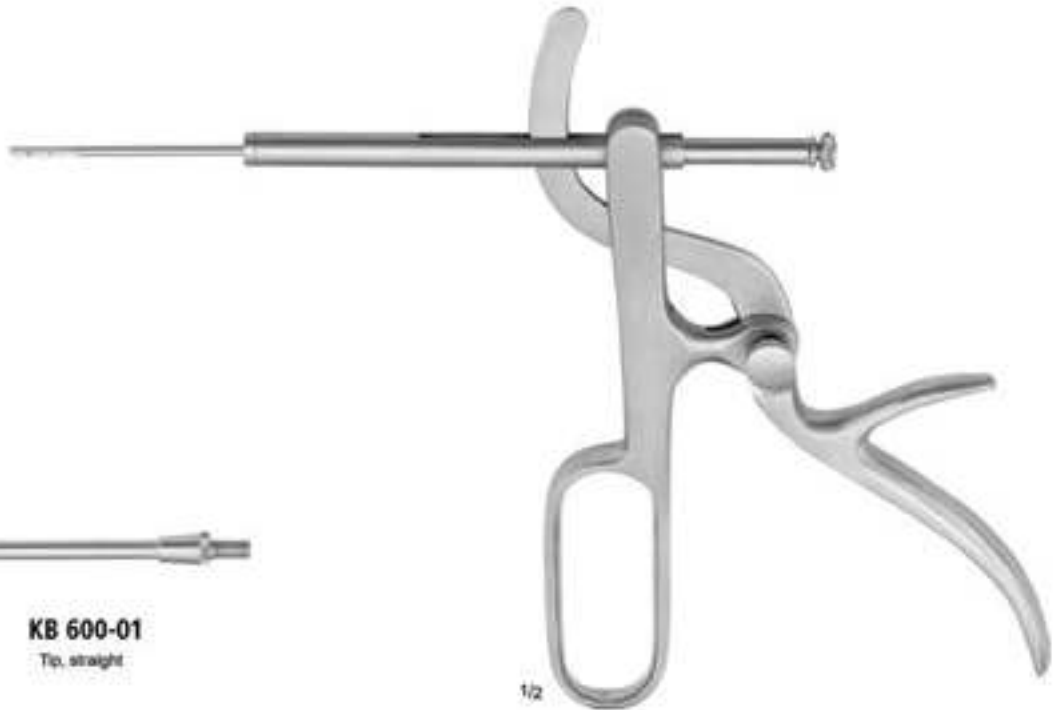

1/2

**TYDING**  
**KB 600-00**

Tonsil snare, with one straight tip



1/2

**KB 600-01**  
Tip, straight



1/2

**KB 600-02**  
Vedder tip

Tonsilektomi - Larengoloji - Traketomi  
Tonsillectomy - Laryngology - Tracheotomy  
Tonsillektomie - Laryngologie - Tracheotomie



**SLUDER-BALLENGER**  
**KB 601-00**

Tonsil guillotine



**KB 601-01**  
Blade



**KB 601-02**  
Blade



**KB 601-03**  
Blade



**EVES**  
**KB 610-25**  
 29 cm, 11 1/4"  
 without ratchet

1/2



**EVES**  
**KB 611-25**  
 29 cm, 11 1/4"  
 with ratchet

1/2



**BRUENINGS**  
**KB 612-27**  
 29 cm, 11 1/4"  
 with ratchet

1/2



**KB 613-03** ø 0,3 mm  
 Snare wires, in bundles of 12 pieces

1/2

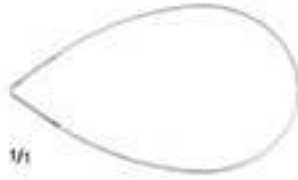

**KB 614-03** ø 0,3 mm

1/1



**KB 615-04** ø 0,4

1/1

Wire loops, in packages of 100 pieces



**KB 616-03** ø 0,3 mm  
**KB 616-04** ø 0,4 mm  
 Snare wires, coil of 10 m



Tonsilektomi - Larengoloji - Traketomi  
Tonsillectomy - Laryngology - Tracheotomy  
Tonsillektomie - Laryngologie - Tracheotomie



**BECKMANN**  
22 cm, 8 5/8"



**KB 620-01**



**KB 620-02**



**KB 620-03**



**KB 620-04**



**KB 620-05**



**KB 620-06**



**BECKMANN (NEGUS)**  
21,5 cm, 8 1/2"



**KB 621-01**



**KB 621-02**



**KB 621-03**



**KB 621-04**



**KB 621-05**



**KB 621-06**



**BARNHILL**  
 21,5 cm, 8½"

1/2



**KB 622-01**



**KB 622-02**



**KB 622-03**



**KB 622-04**



**KB 622-05**



**ST. CLAIR-THOMSON**  
 22,5 cm, 8½"  
 with basket

1/2



**KB 623-01**



**KB 623-02**



**KB 623-03**



**KB 623-04**



**KB 623-05**



**KB 623-06**

Tonsilektomi - Larengoloji - Traketomi  
 Tonsillectomy - Laryngology - Tracheotomy  
 Tonsillektomie - Laryngologie - Tracheotomie



**STUBBS**  
 21 cm, 8 1/4"



**KB 624-01**



**KB 624-02**



**KB 624-03**



**KB 624-04**



**KB 624-05**



**LA FORCE**  
 25 cm, 9 1/4"

Spare blades, unperforated



**KB 625-01**



**KB 625-02**



**KB 625-03**

Spare blades, perforated



**KB 625-04**



**KB 625-05**



**KB 625-06**



**KB 630-00**

34 cm, 13 3/8"

Chest support, for adults, complete with support rod

24 cm, 9 1/2"

Support rod for children

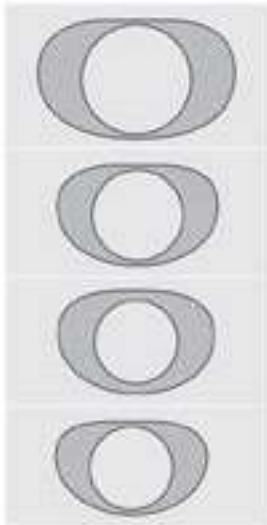

**KB 631-01**

**KB 631-02**

**KB 631-03**

**KB 631-04**



Operation laryngoscopes

Fibro optic light carrier, for operating laryngoscopes



1/2

**KB 631-10**



1/2

**KB 631-11**



Micro grasping Forceps



Micro scissors

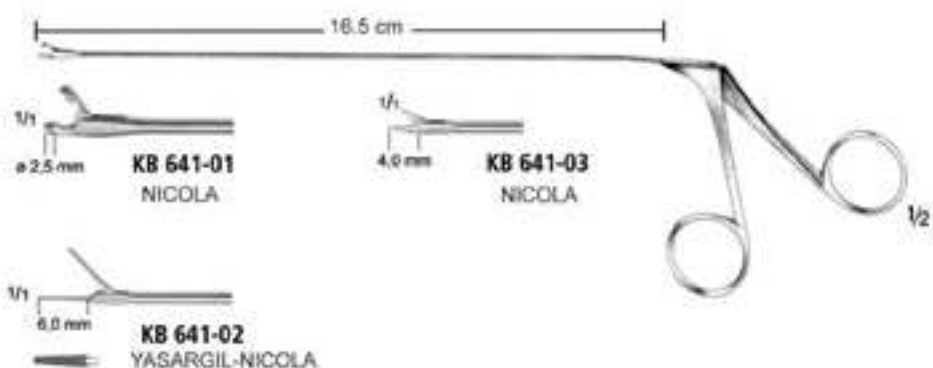



**HUBER**  
**KB 650-01**



**FRAENKEL**  
**KB 653-01**



**SEIFFERT**  
**KB 653-02**



**FRAENKEL**  
**KB 653-03**



**LANGE**  
**KB 653-04**



**SCHEINMANN**  
**KB 653-05**



**SCHEINMANN**  
**KB 653-06**



**LEASURE**  
**KB 653-07**



**CORDES**  
**KB 653-08**



**CORDES**  
**KB 653-09**



**BRUENINGS**

- KB 651-01 20 cm, 7 1/4"
- KB 651-02 30 cm, 11 1/4"
- KB 651-03 40 cm, 15 1/4"
- KB 651-04 50 cm, 19 1/4"



**BRUENINGS**  
**KB 652-01**  
 20 cm, 7 1/4"



**BRUENINGS**

- KB 654-01 Fig. 0/e 2,5 mm
- KB 654-02 Fig. 1/e 3,0 mm
- KB 654-03 Fig. 2/e 4,0 mm



**BRUENINGS**

- KB 655-01 Fig. 0/e 2,5 mm
- KB 655-02 Fig. 1/e 3,0 mm
- KB 655-03 Fig. 2/e 4,0 mm



**KRAUSE**

- KB 656-01 Fig. 1
- KB 656-02 Fig. 2

Fig. 1

Fig. 2





**Tonsilektomi - Larengoloji - Traketomi**  
**Tonsillectomy - Laryngology - Tracheotomy**  
**Tonsillektomie - Laryngologie - Tracheotomie**

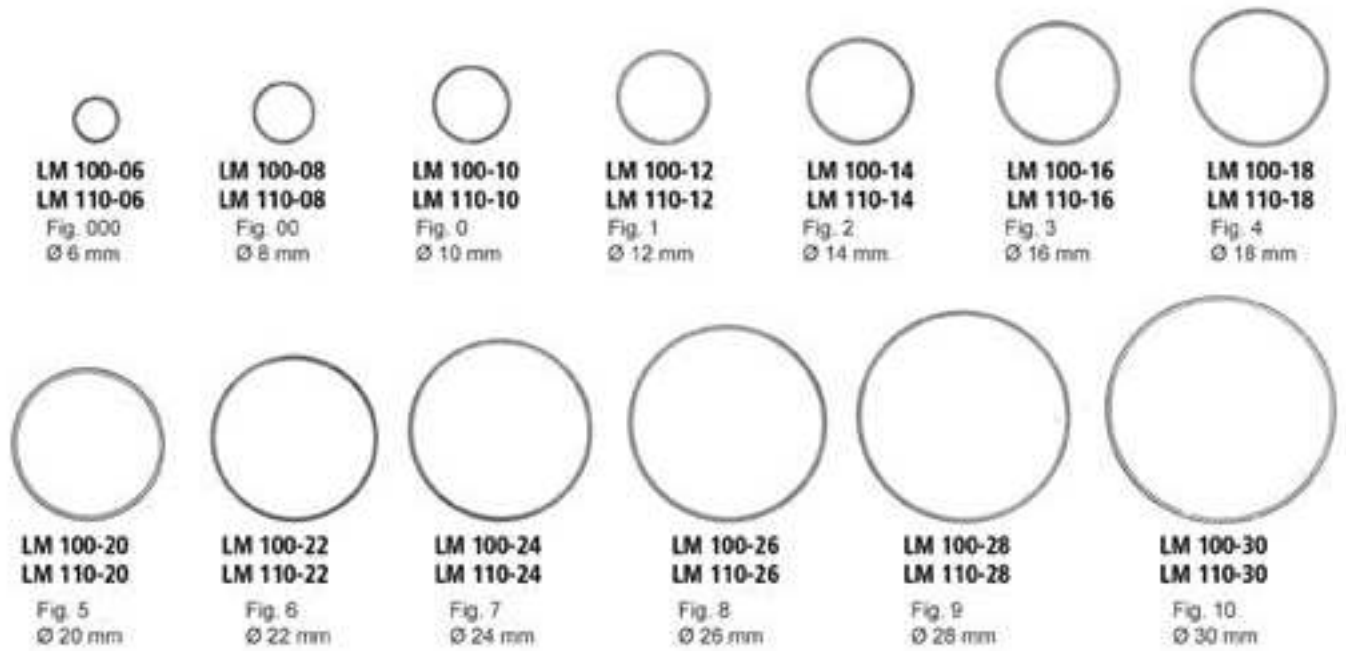



Tonsilektomi - Larengoloji - Traketomi  
Tonsillectomy - Laryngology - Tracheotomy  
Tonsillektomie - Laryngologie - Tracheotomie



METZENBAUM



MA 155-11  
11,5 cm, 4½"



MA 156-11  
11,5 cm, 4½"



BABY-METZENBAUM



MA 210-14  
14,5 cm, 5¾"



MA 211-14  
14,5 cm, 5¾"



METZENBAUM



MA 214-18  
18 cm, 7¼"



MA 215-18  
18 cm, 7¼"



MA 214-20  
20,5 cm, 8¾"



MA 215-20  
20,5 cm, 8¾"



**THOREK**  
 18,5 cm, 7¼"



**MA 223-19**



**JOSEPH**



**MA 228-14**  
 14 cm, 5½"



**MA 229-14**  
 14 cm, 5½"



**REYNOLDS**  
 blades serrated



**MA 233-15**  
 14,5 cm, 5¾"



**MA 233-18**  
 18 cm, 7"



**JAMESON**



**MA 354-15**  
 15,5 cm, 6"



**MA 354-18**  
 18 cm, 7"





**MA 561-10**  
 10,5 cm, 4½"



**MA 562-10**  
 10,5 cm, 4½"



**MA 573-10**  
 10,5 cm, 4½"



**MA 574-10**  
 10,5 cm, 4½"



**STEVENS**



**MA 575-10**  
 10,5 cm, 4½"



**MA 576-10**  
 10,5 cm, 4½"



**MA 561-11**  
 11,5 cm, 4½"



**MA 562-11**  
 11,5 cm, 4½"



**HARVEY**  
 12,5 cm, 5"  
 Wire cutting scissors,  
 1 blade serrated



**MA 601-12**



**UNIVERSAL**  
 12 cm, 4½"  
 Wire cutting scissors,  
 1 blade serrated



**MA 604-12**



**DEAN**  
 17 cm, 6½"



**MA 718-17**  
 1 blade serrated

Tonsilektomi - Larengoloji - Traketomi  
 Tonsillectomy - Laryngology - Tracheotomy  
 Tonsillektomie - Laryngologie - Tracheotomie

Hard Metal Edged

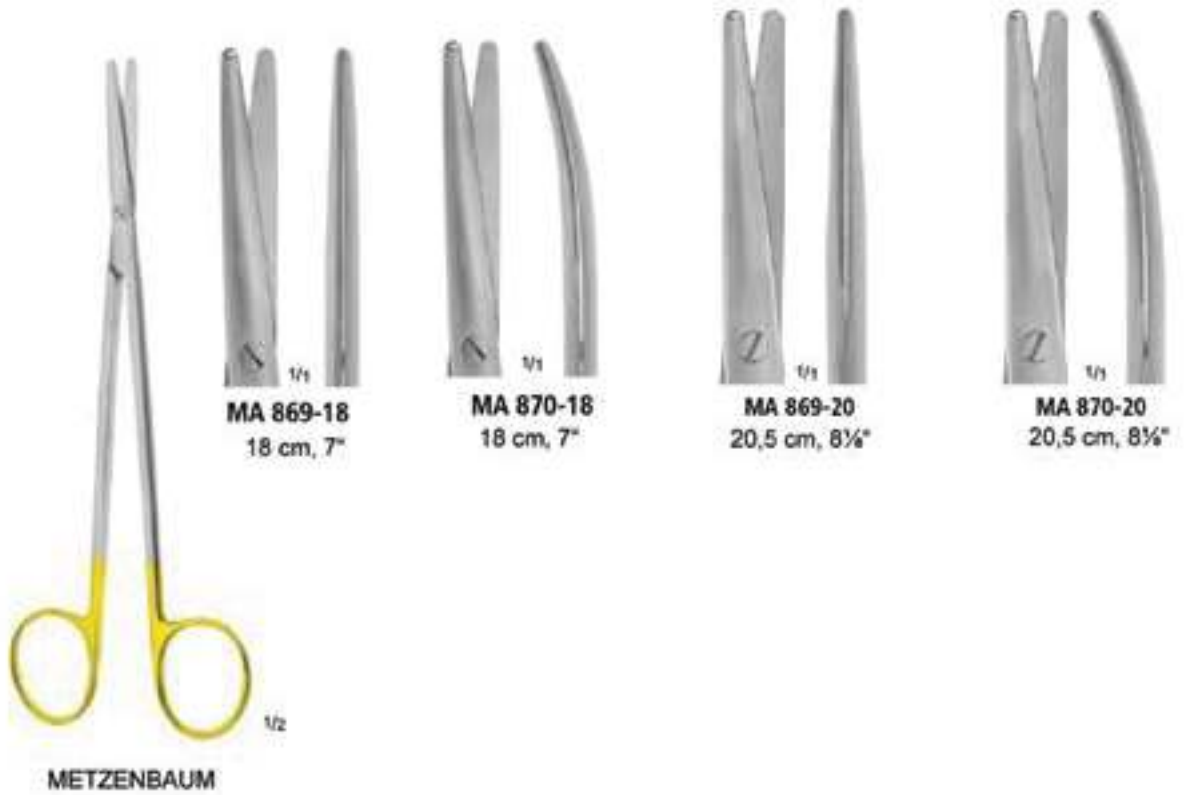

**SUPER CUT**

Hard Metal Edged



BABY-METZENBAUM



MA 891-11  
11,5 cm, 4½"



MA 892-11  
11,5 cm, 4½"



METZENBAUM



MA 891-14  
14,5 cm, 5¾"



MA 892-14  
14,5 cm, 5¾"



METZENBAUM



MA 891-18  
18 cm, 7"



MA 892-18  
18 cm, 7"



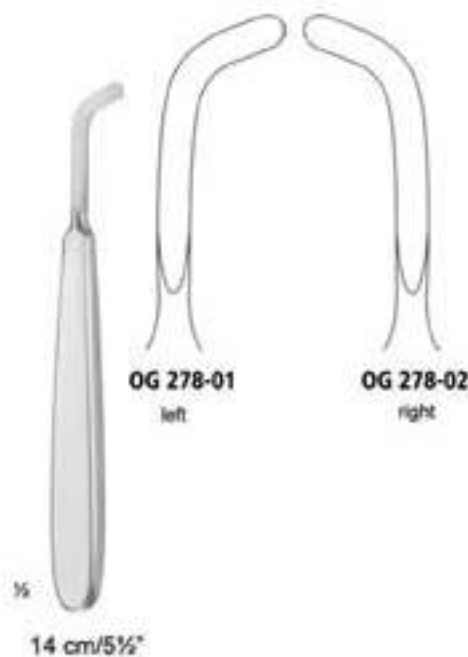
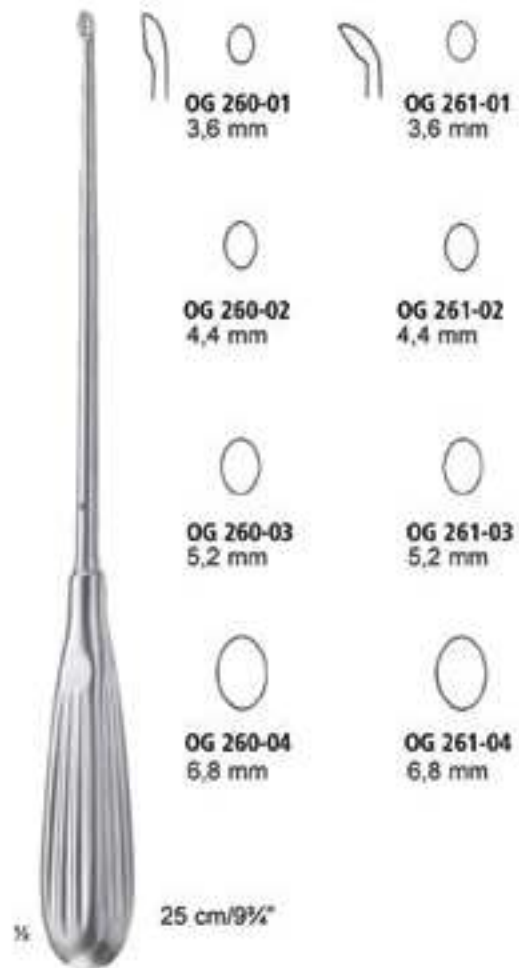



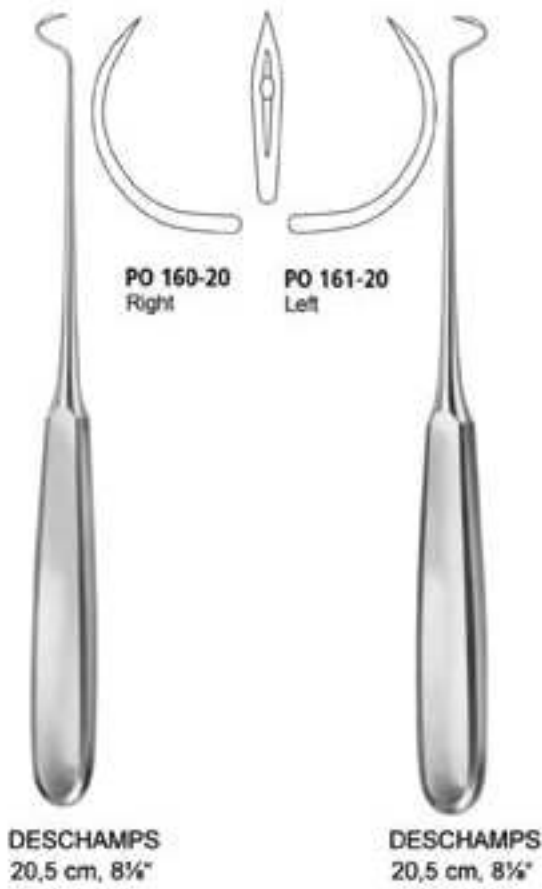

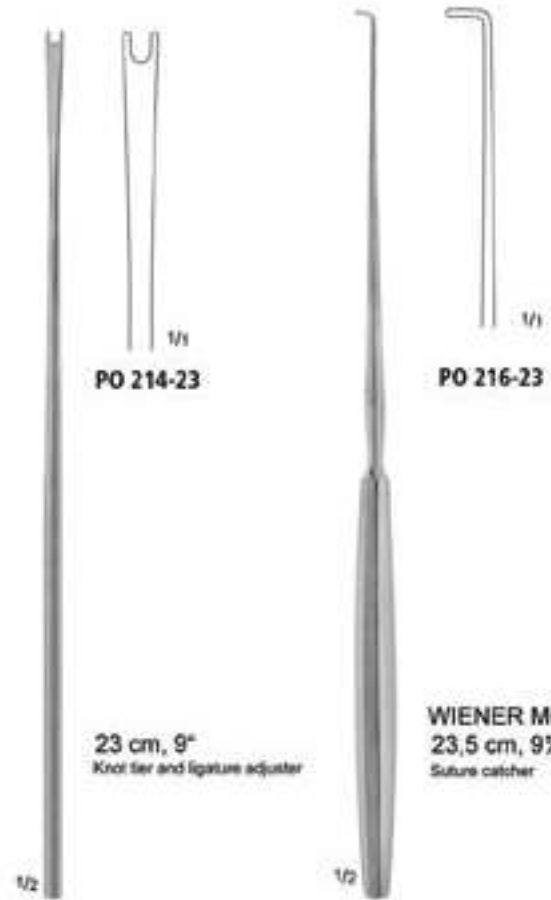
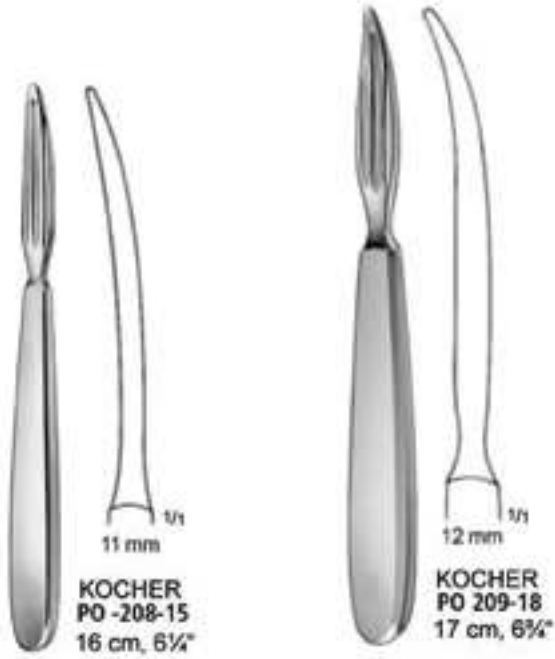



**HALSEY**  
 13 cm/5 1/8"



**PO 915-13**  
 smooth jaw



**PO 916-13**



**CRILE WOOD**



**PO 919-15**  
 15 cm/6"



**PO 920-18**  
 18 cm/7"



**PO 920-20**  
 20 cm/7 1/4"



**MATHIEU**



**PO 926-14**  
 14 cm/5 1/2"



**PO 926-17**  
 17 cm/6 3/4"



**PO 926-20**  
 20 cm/8"



**PO 926-24**  
 24 cm/9 1/2"



**PO 937-18**



**TOENNIS**  
 18 cm/7"



**PO 942-18**  
 18 cm/7"



**PO 942-20**  
 20,5 cm/8"



**PO 942-23**  
 23 cm/9"



**LANGENBECK**



**FARRELL**  
 16 cm, 6 1/4" SO 211-16  
 18 cm, 7" SO 211-18  
 Cotton applicators, spiral serrated



**FARRELL**  
 16 cm, 6 1/4" SO 212-16  
 18 cm, 7" SO 212-18  
 Cotton applicators, triangular serrated



**SO 212-28**  
 28 cm, 11"  
 Cotton applicators,  
 rough, spiral end



**FEIN**  
 SO 215-28  
 28 cm, 11"  
 rough, spiral end



**REICHERT**  
 SO 219-23  
 23,5 cm, 9 1/4"  
 Epiglottis retractor

