



BS - 200 - 03  
No. 3



BS - 201 - 03  
No. 3



BS - 201 - 04  
No. 4



BS - 202 - 13  
No. 3L

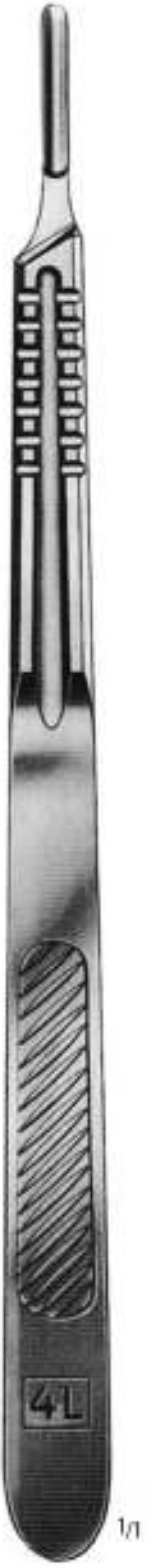

BS - 203 - 14  
No. 4L

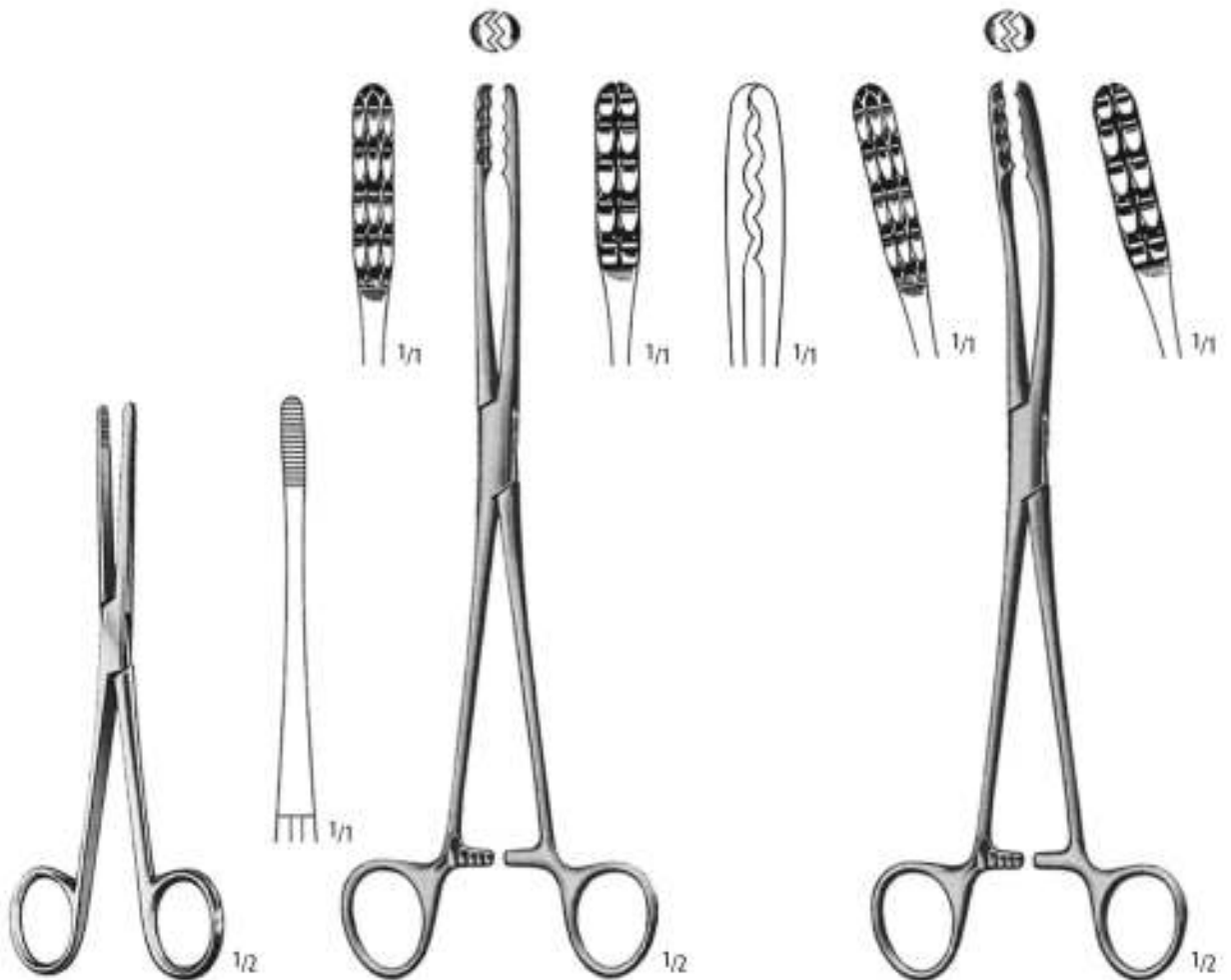

**LISTER**  
 13,0 cm/5 1/4" CM - 200 - 13  
 16,0 cm/6 1/4" CM - 200 - 16  
 18,0 cm/7" CM - 200 - 18

**ULRICH**  
 CM - 201 - 22  
 CM - 201 - 25  
 22,0 cm/8 3/4"  
 25,0 cm/10"

**ULRICH**  
 CM - 202 - 22  
 CM - 203 - 25



**CHERON**  
CM - 213 - 25  
25,0 cm/10"



**COLLIN**  
CM - 214 - 24  
24,0 cm/9 1/2"



**NOTO**  
CM - 215 - 28  
27,5 cm/10 3/4"

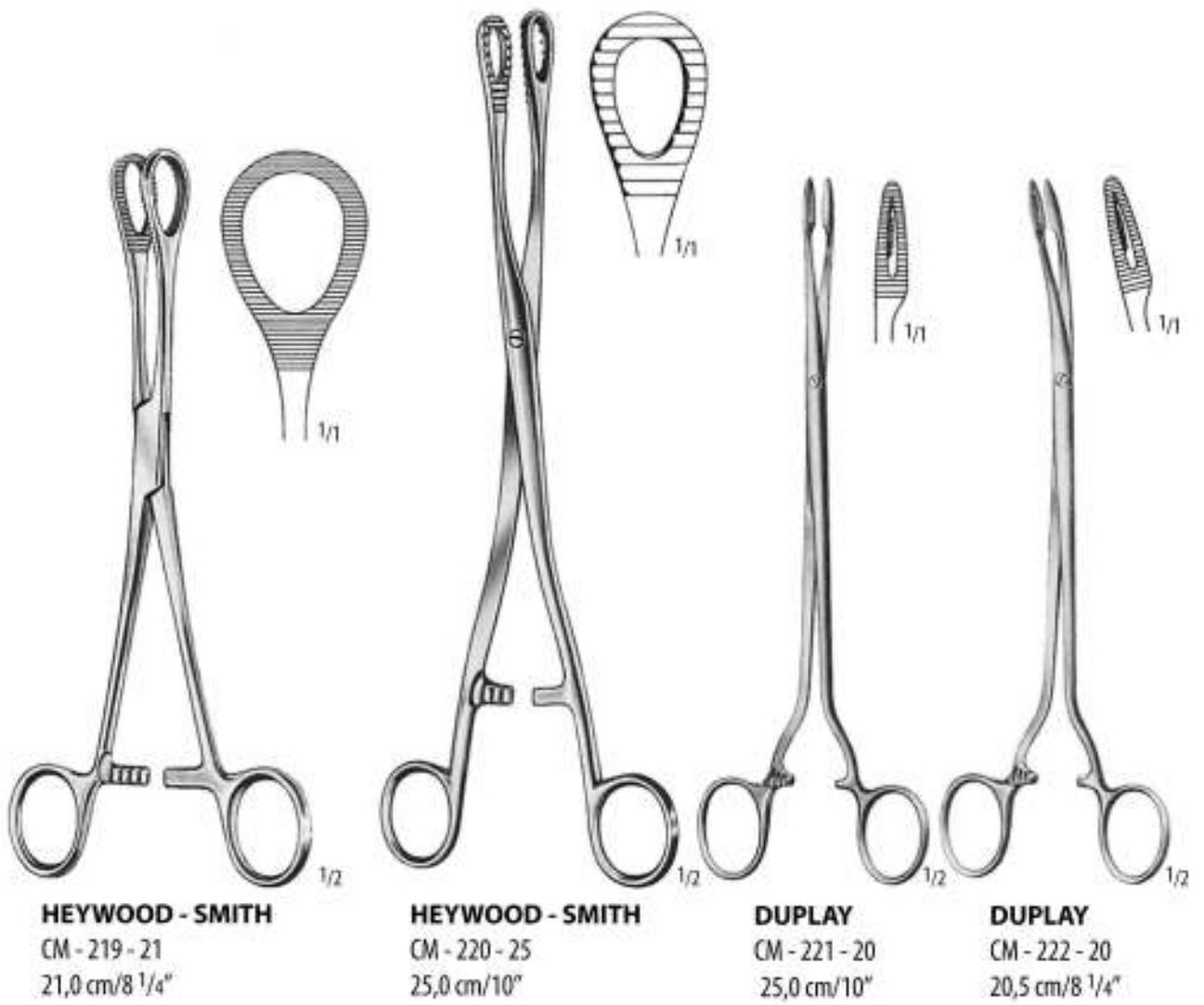



**FOERSTER - BALLEGER**



CM - 223 - 18  
CM - 223 - 20



CM - 224 - 18 18,0 cm/7"  
CM - 224 - 20 20,0 cm/8"



CM - 225 - 18  
CM - 225 - 20



CM - 226 - 18  
CM - 226 - 20



CM - 223 - 25



CM - 224 - 25



CM - 225 - 25



CM - 226 - 25



**SOMER**  
CM 250-01 23,5 cm 9 1/4

**DARTIGUES**  
CM 251-01 25,5 cm 10"

**COLLIN**  
CM 252-01 26,5 cm 10 1/2

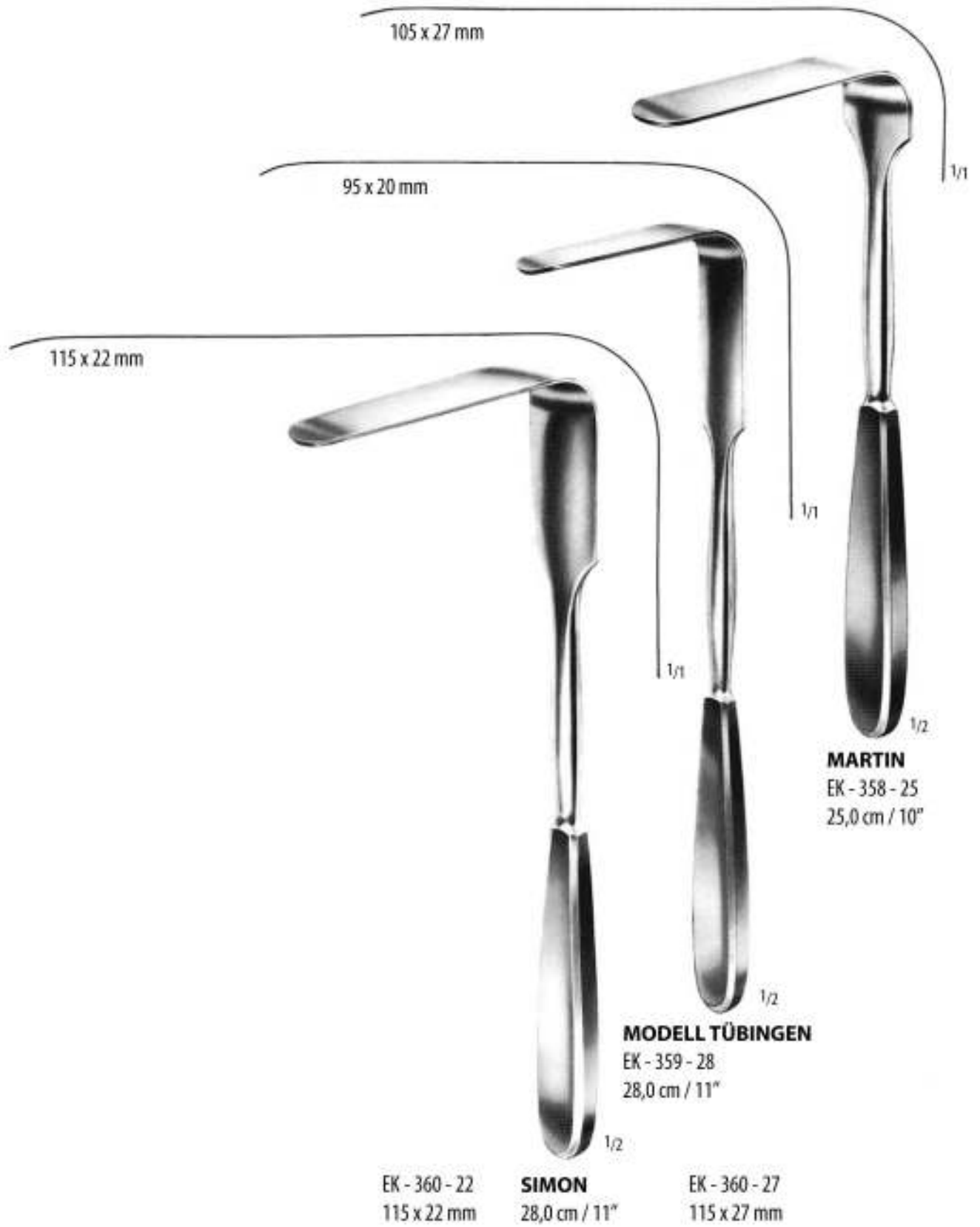



**FRITSCH**  
24,0 cm / 9 1/2"

45 x 40 mm	EK - 374 - 40
45 x 50 mm	EK - 374 - 50
45 x 60 mm	EK - 374 - 60
45 x 75 mm	EK - 374 - 75
65 x 85 mm	EK - 374 - 85

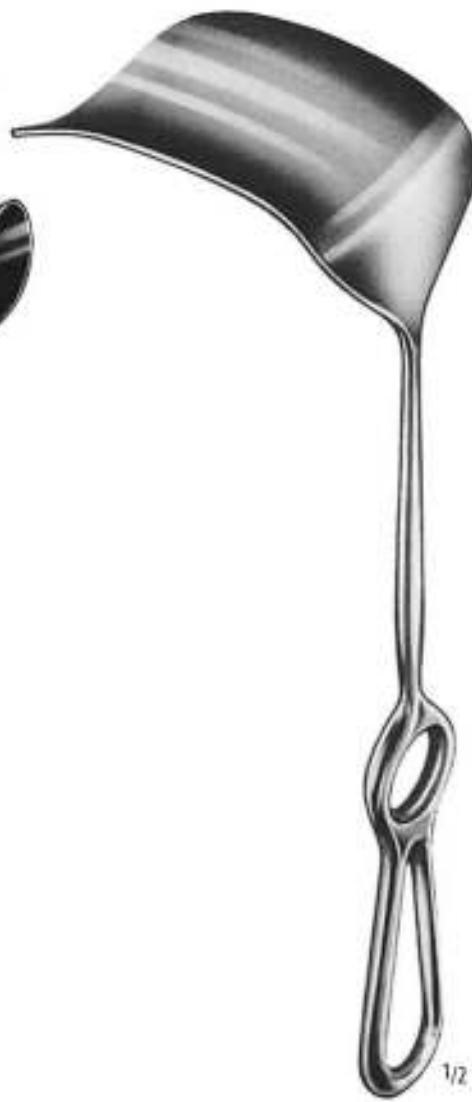

**KOCHER**

70 x 25 mm	22,0 cm / 9"	EK - 375 - 25
80 x 42 mm	25,0 cm / 10"	EK - 375 - 42
80 x 50 mm	25,0 cm / 10"	EK - 375 - 50
80 x 60 mm	25,0 cm / 10"	EK - 375 - 60



**DOYEN - STILLE**  
24,0 cm / 9 1/2"

90 x 15 mm	EK - 377 - 15
90 x 20 mm	EK - 377 - 20
90 x 30 mm	EK - 377 - 30
110 x 35 mm	EK - 377 - 35
110 x 40 mm	EK - 377 - 40
120 x 55 mm	EK - 377 - 55





mm	BREISKY
100x20	EK 376-01
100x25	EK 376-02
100x30	EK 376-03
100x35	EK 376-04
100x40	EK 376-05
130x20	EK 376-20
130x25	EK 376-25
130x30	EK 376-30
130x35	EK 376-35
130x40	EK 376-40
155x40	EK 378-40

70 x 30 mm



DOYEN  
EK 390-25  
25,0 cm

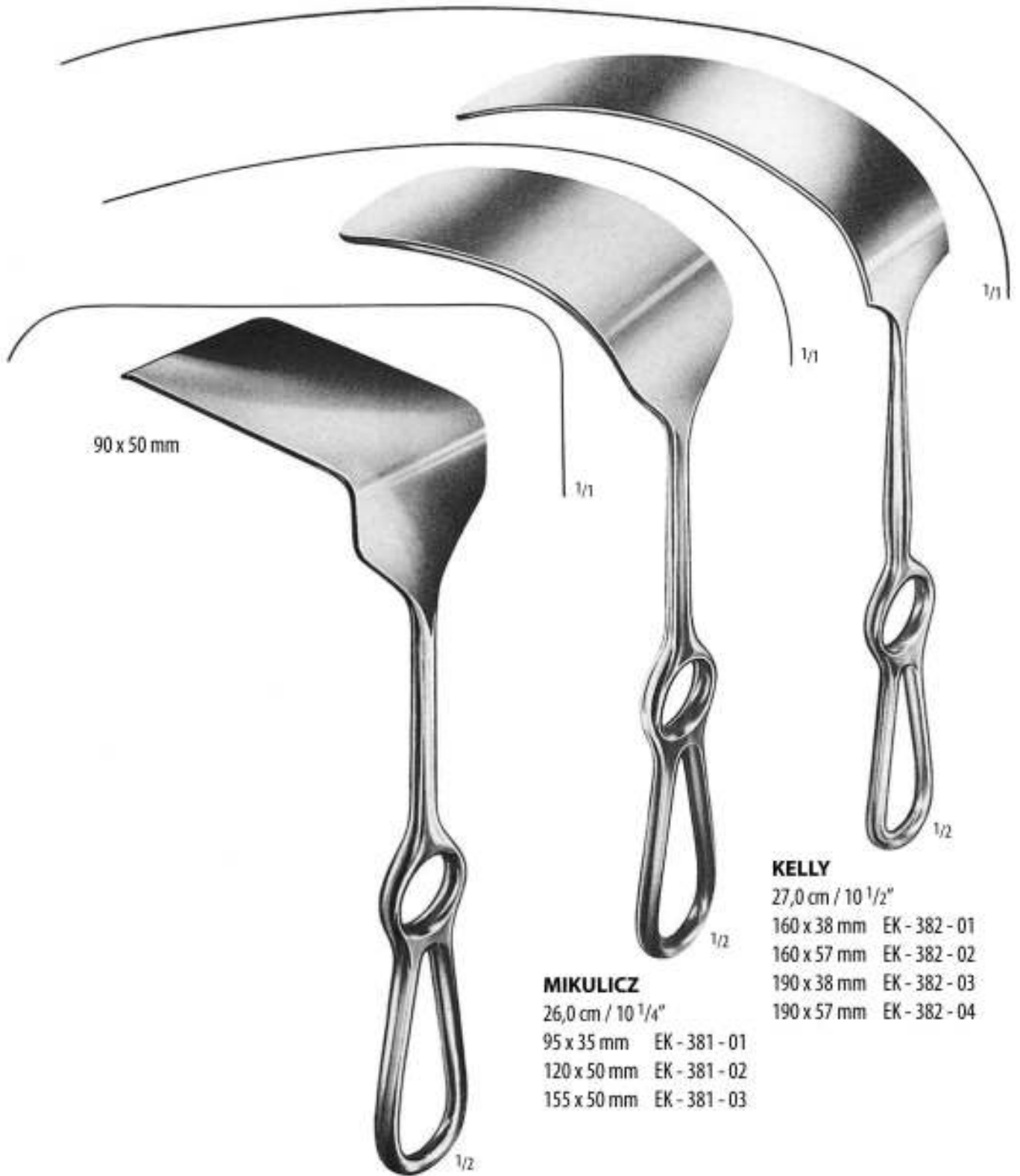

90 x 50 mm

1/1

1/1

1/1

1/2

1/2

1/2

**MIKULICZ**

EK - 380 - 26

26,0 cm / 10 1/4"

**MIKULICZ**

26,0 cm / 10 1/4"

95 x 35 mm EK - 381 - 01

120 x 50 mm EK - 381 - 02

155 x 50 mm EK - 381 - 03

**KELLY**

27,0 cm / 10 1/2"

160 x 38 mm EK - 382 - 01

160 x 57 mm EK - 382 - 02

190 x 38 mm EK - 382 - 03

190 x 57 mm EK - 382 - 04



**COLLIN**  
EK - 507 - 10  
22,0 cm / 8 3/4"

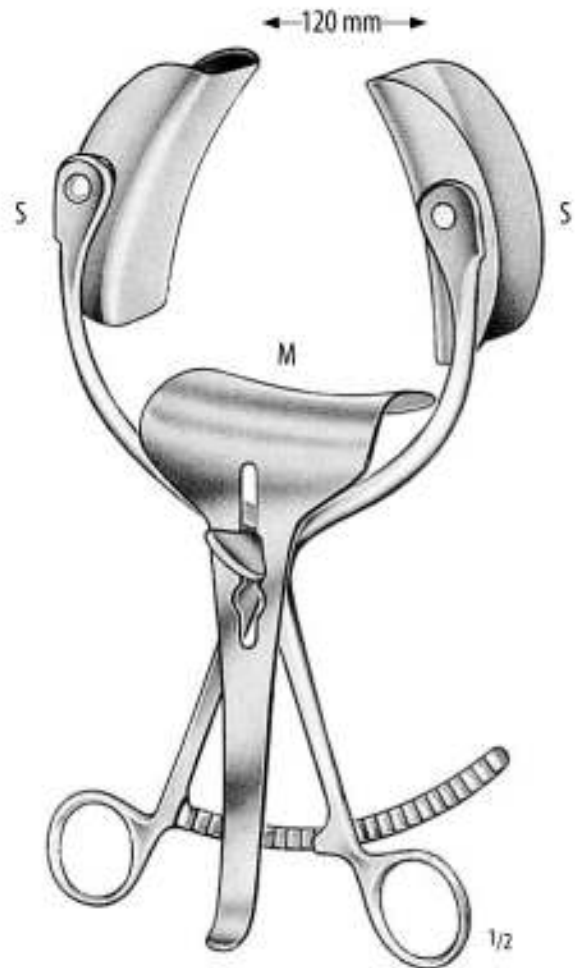

**COLLIN**

	S	M
EK - 508 - 12	38 x 62 mm	55 x 55 mm
EK - 509 - 12	38 x 80 mm	55 x 65 mm
EK - 510 - 12	38 x 100 mm	55 x 75 mm

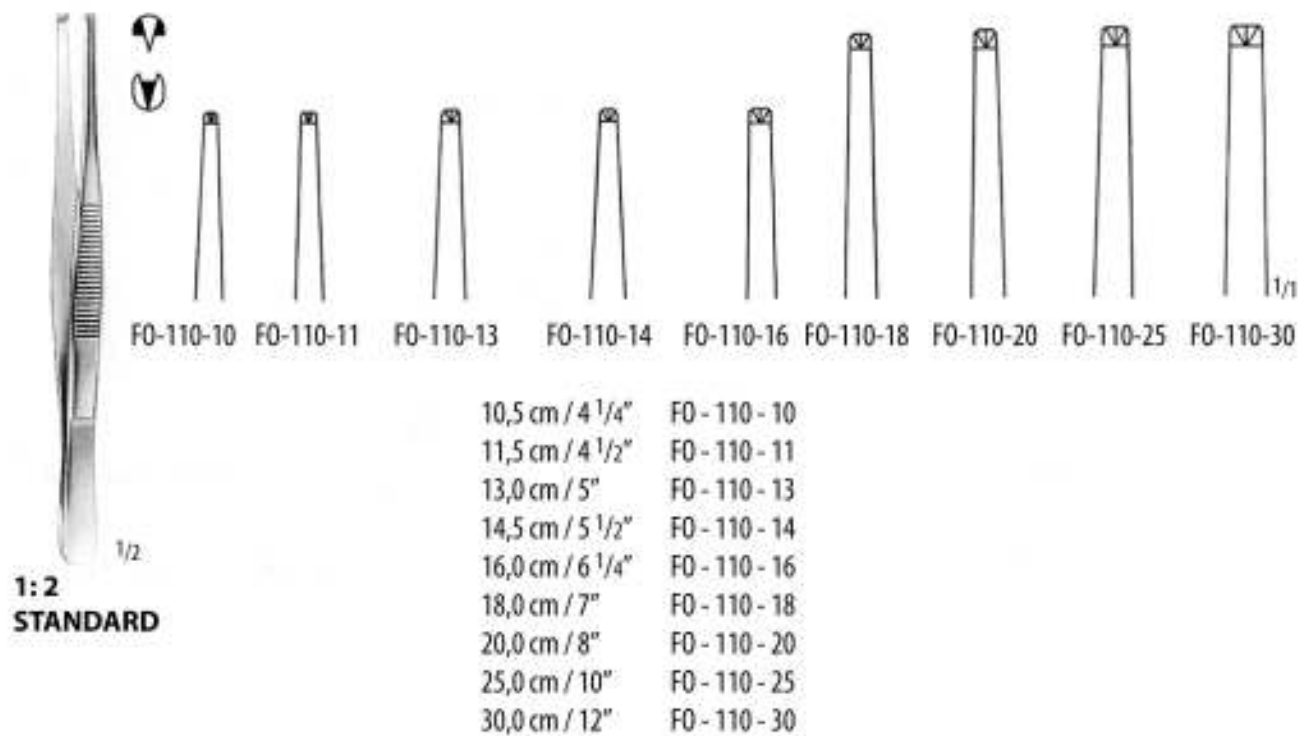
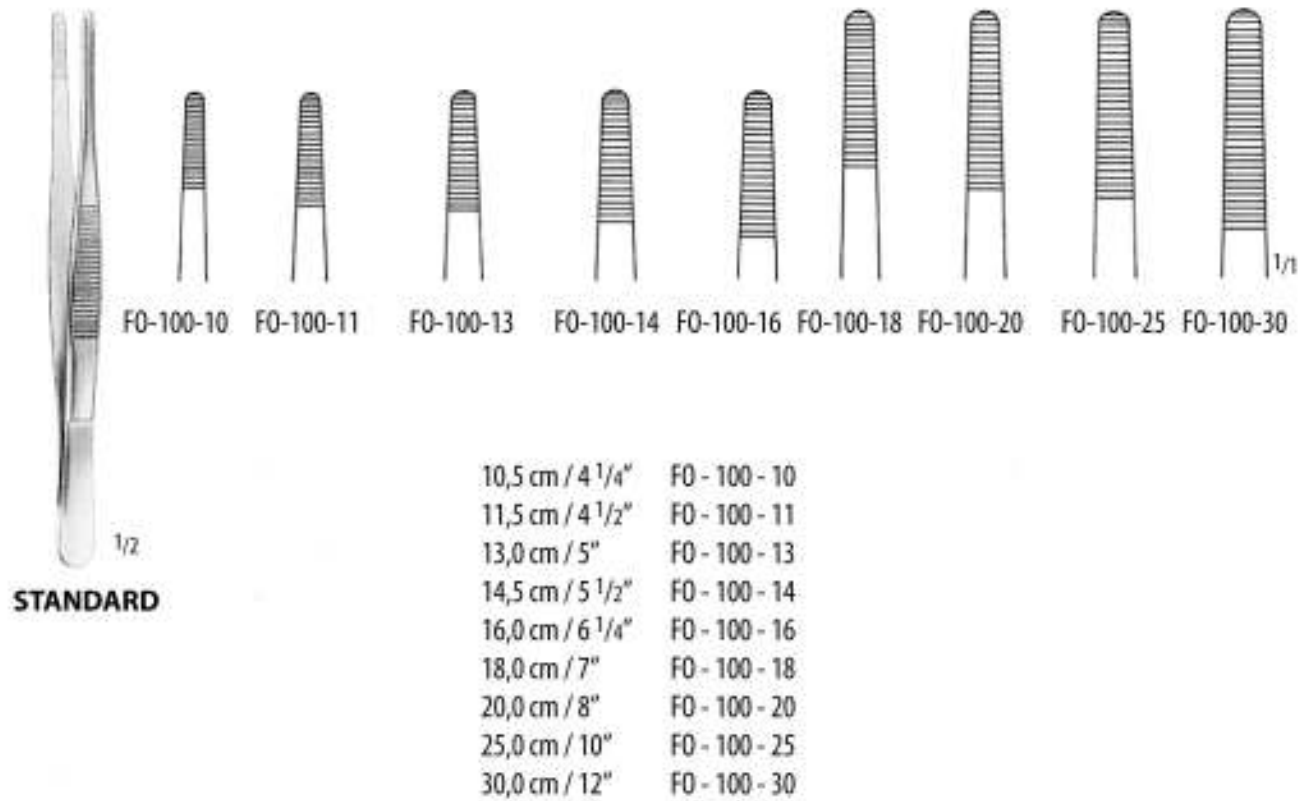

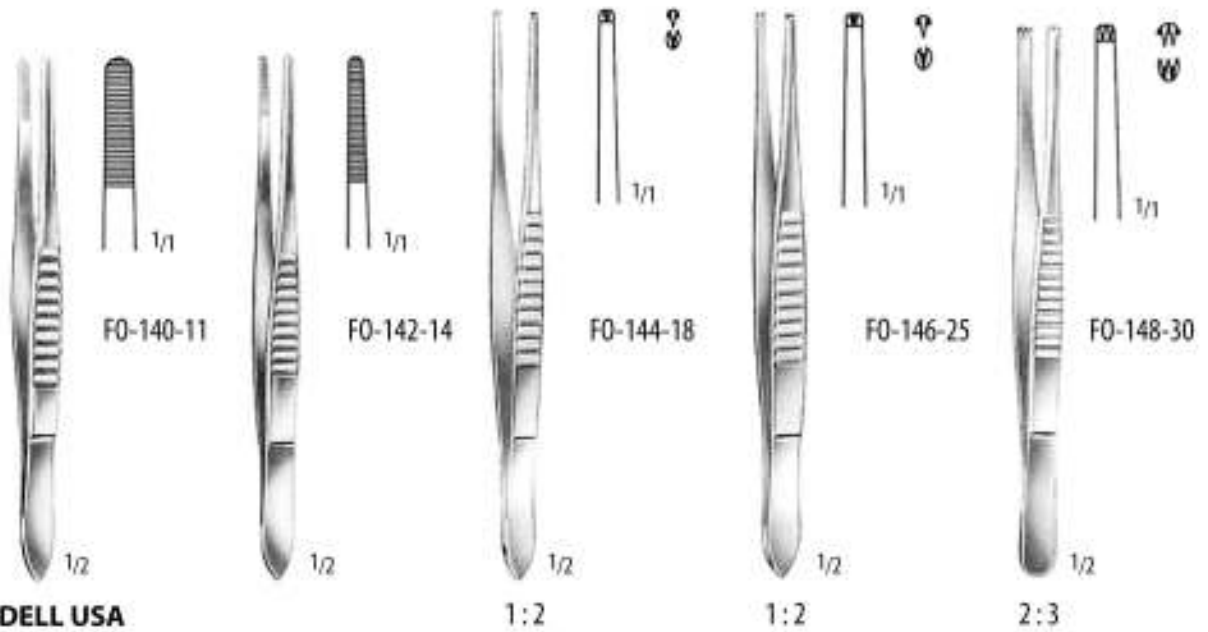

narrow

12,0 cm / 4 3/4"	FO - 140 - 12	FO - 142 - 12	FO - 144 - 13	FO - 146 - 12	FO - 148 - 12
13,0 cm / 5"	FO - 140 - 13	FO - 142 - 13	FO - 144 - 14	FO - 146 - 13	FO - 148 - 13
14,5 cm / 5 1/2"	FO - 140 - 14	FO - 142 - 14	FO - 144 - 15	FO - 146 - 14	FO - 148 - 14
15,5 cm / 6"	FO - 140 - 15	FO - 142 - 15		FO - 146 - 15	FO - 148 - 15
18,0 cm / 7"	FO - 140 - 18			FO - 146 - 18	FO - 148 - 18
21,0 cm / 8 1/4"	FO - 140 - 21			FO - 146 - 21	FO - 148 - 21
25,0 cm / 10"	FO - 140 - 25			FO - 146 - 25	FO - 148 - 25
31,0 cm / 12 1/4"	FO - 140 - 31			FO - 146 - 31	FO - 148 - 31

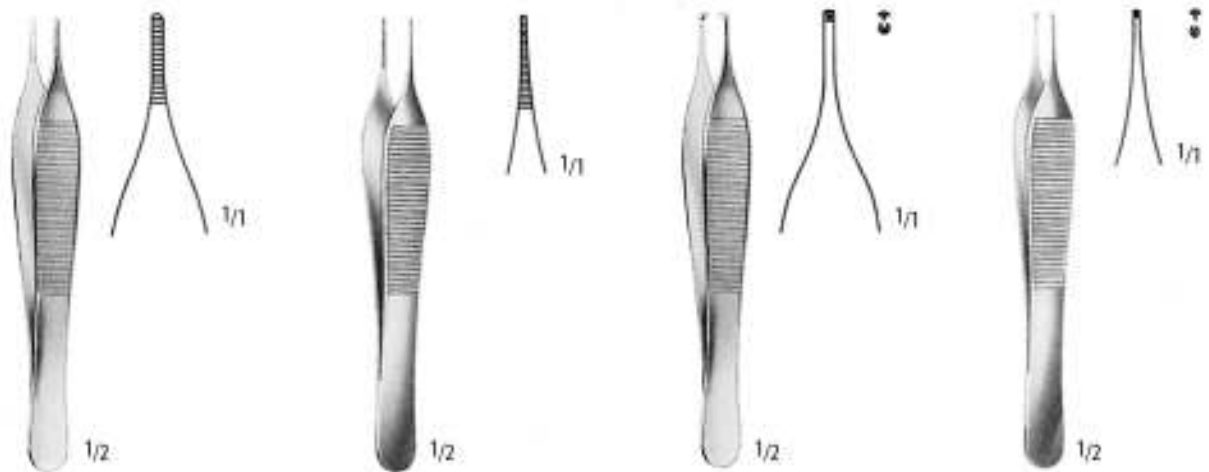

12,0 cm / 4 3/4"	<b>ADSON</b> FO - 200 - 12	<b>MICRO - ADSON</b> FO - 201 - 12	<b>ADSON 1 : 2</b> FO - 202 - 12	<b>MICRO - ADSON 1 : 2</b> FO - 203 - 12
15,0 cm / 6"	FO - 200 - 15	FO - 201 - 15	FO - 202 - 15	FO - 203 - 15

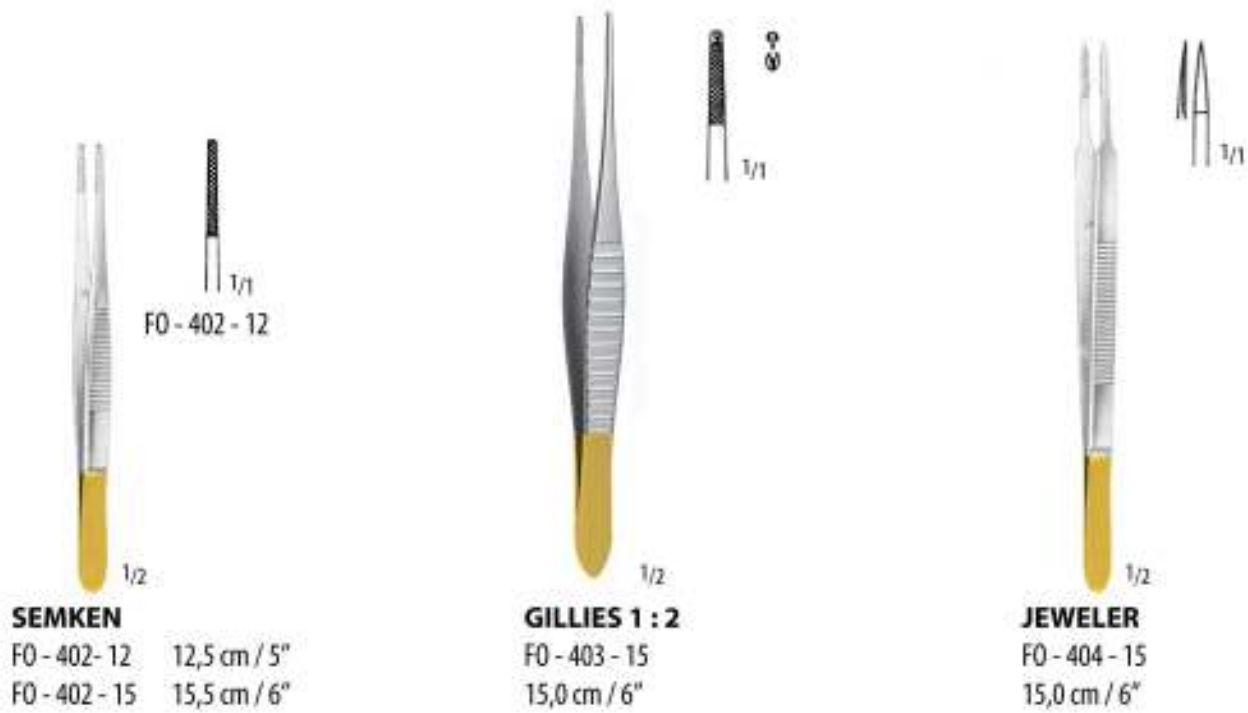
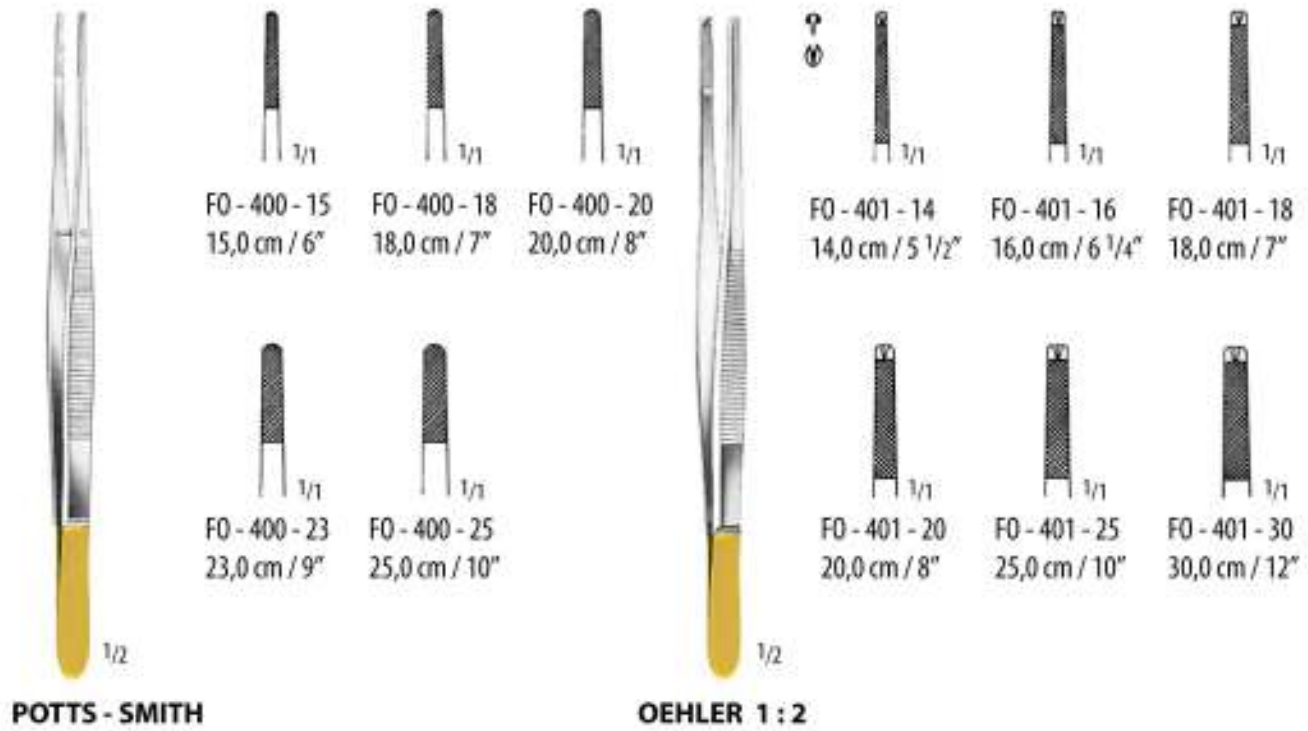



**ALLIS 4 : 5**  
HM - 400 - 15  
15,0 cm / 6"



**ALLIS 5 : 6**  
15,0 cm / 6"      HM - 401 - 15  
19,0 cm / 7 1/2"      HM - 401 - 19  
25,0 cm / 10"      HM - 401 - 25



**BABCOCK**



HM - 410 - 16  
16,0 cm / 6 1/4"



HM - 410 - 18  
18,0 cm / 7"



HM - 410 - 20  
20,0 cm / 8"



HM - 410 - 24  
24,0 cm / 9 1/2"



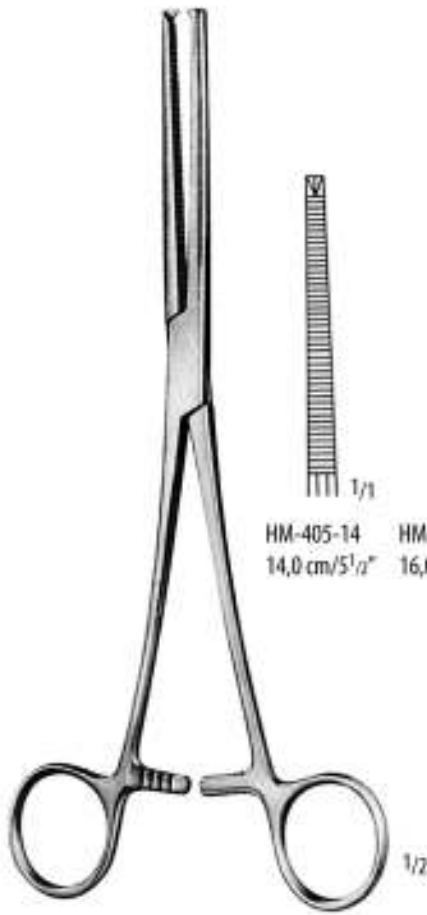

**OCHSNER - KOCHER 1 : 2**

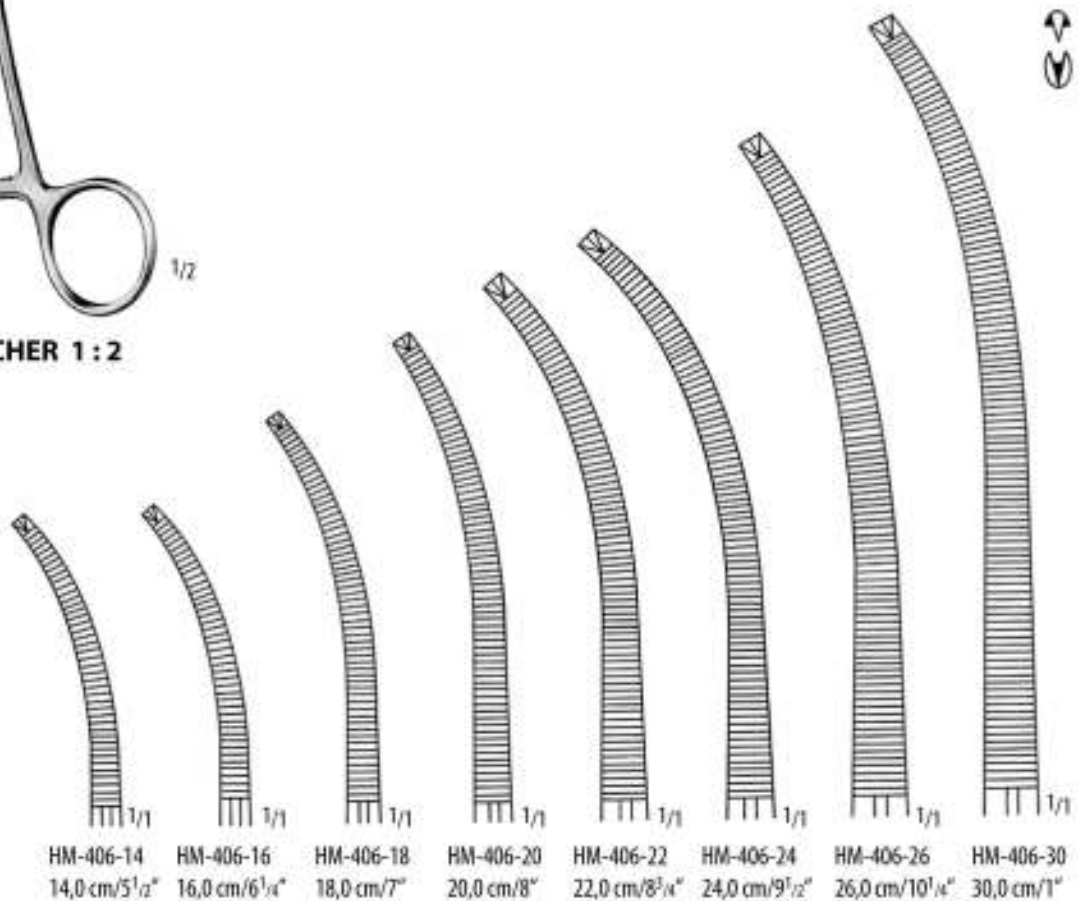
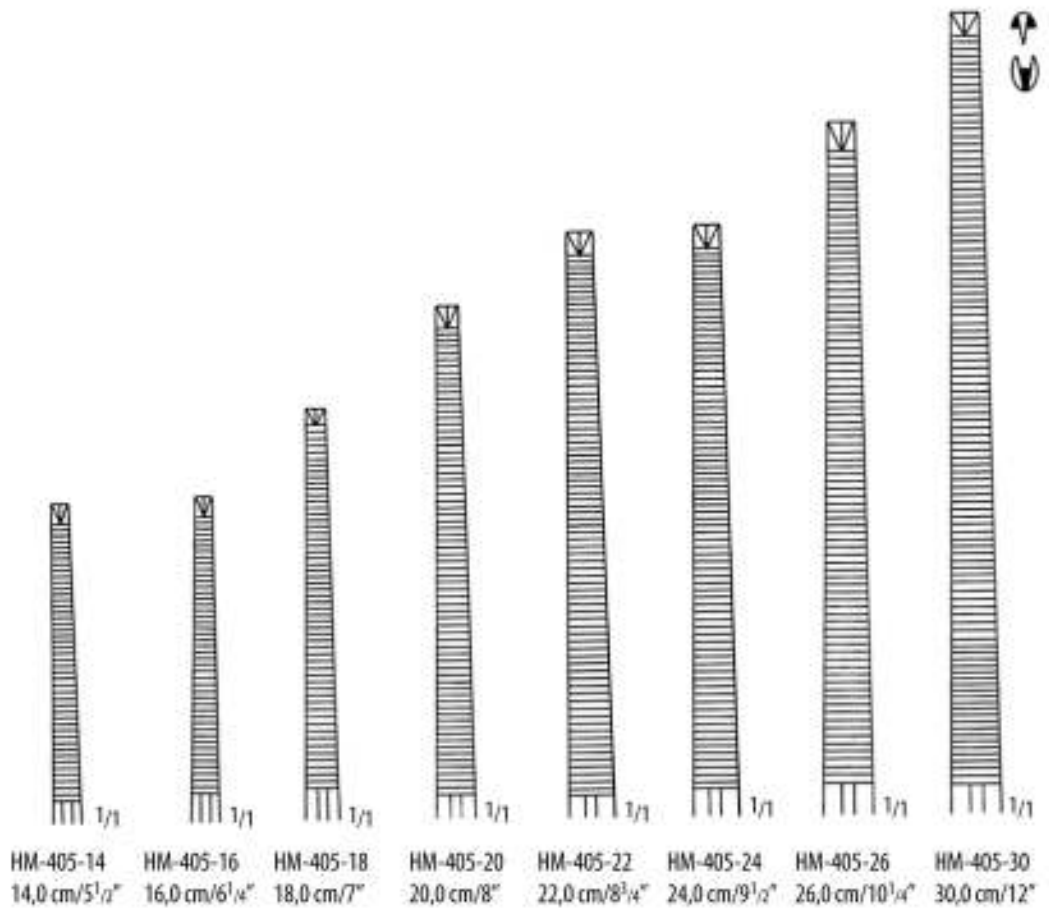



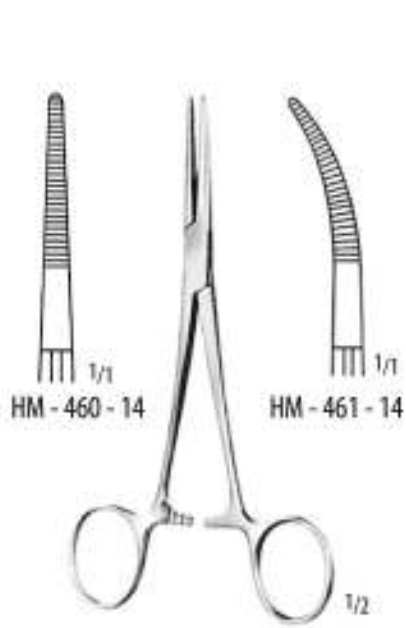

**KELLY**  
14,0 cm / 5 1/2"

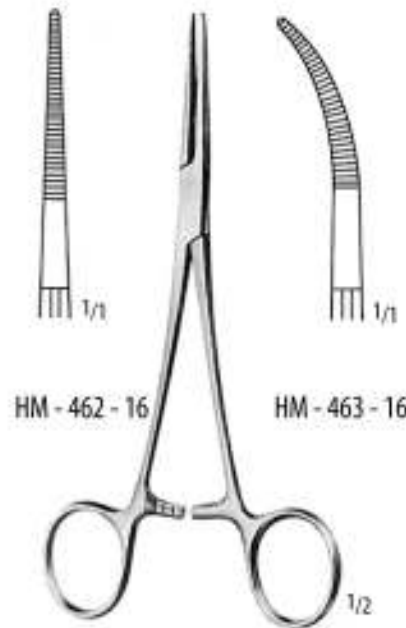

**KELLY - RANKIN**  
16,0 cm / 6 1/4"

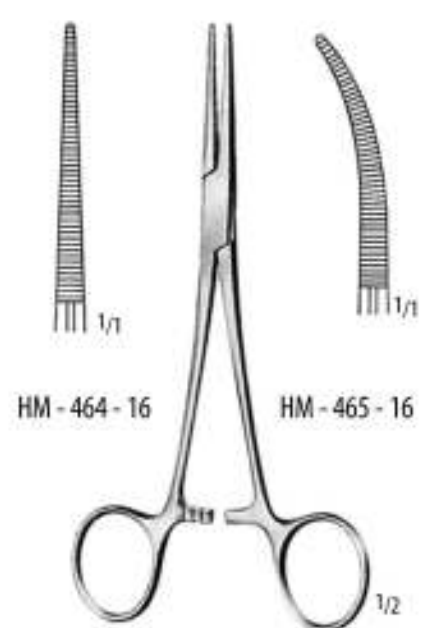

**COLLER**  
14,0 cm / 5 1/2"  
16,0 cm / 6 1/4"

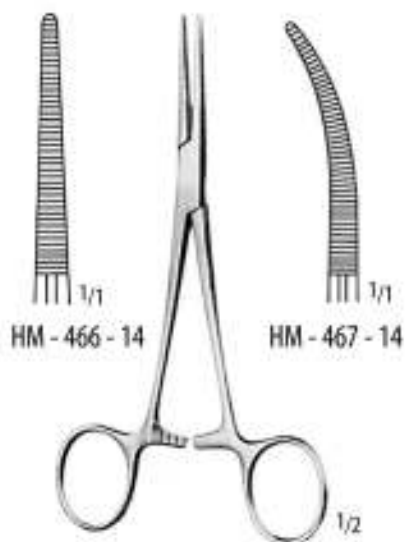

**CRILE**  
14,0 cm / 5 1/2"

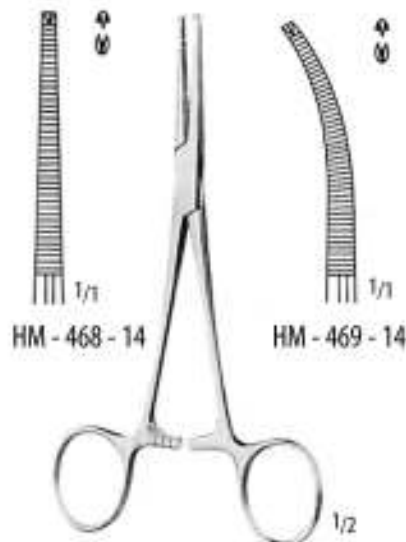

**CRILE 1 : 2**  
14,0 cm / 5 1/2"

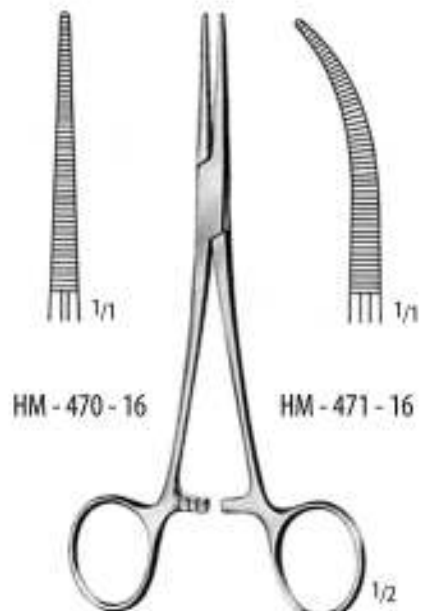

**CRILE - RANKIN**  
16,0 cm / 6 1/4"



**KANTROWITZ**

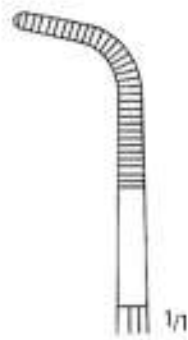

HM - 530 - 20  
20,0 cm / 8"

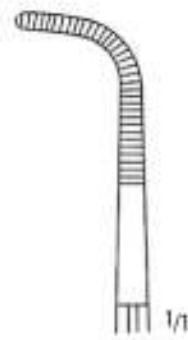

HM - 530 - 24  
24,0 cm / 9 1/2"

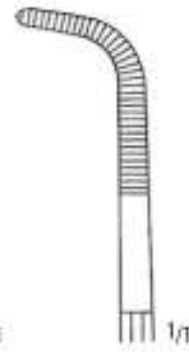

HM - 530 - 28  
28,0 cm / 11"

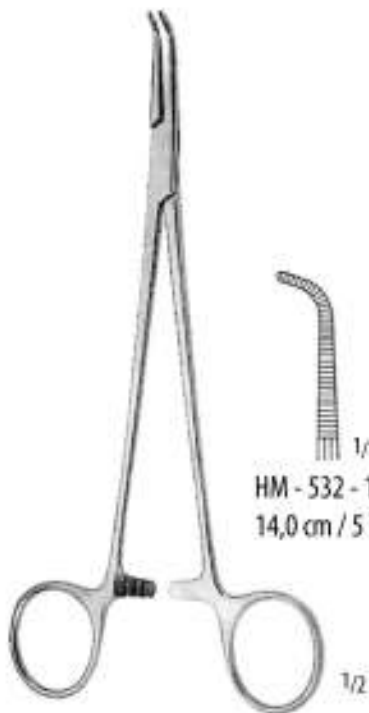

**GEMINI**



HM - 532 - 14  
14,0 cm / 5 1/2"



HM - 532 - 18  
18,0 cm / 7"



HM - 532 - 22  
22,0 cm / 8 3/4"



HM - 532 - 25  
25,0 cm / 10"

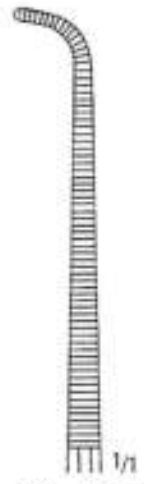

HM - 532 - 28  
28,0 cm / 11"

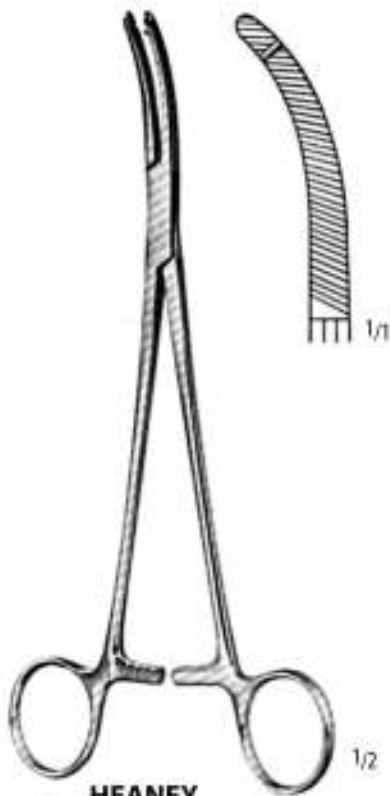

**HEANEY**

HM - 570 - 21  
21,0 cm / 8 1/4"

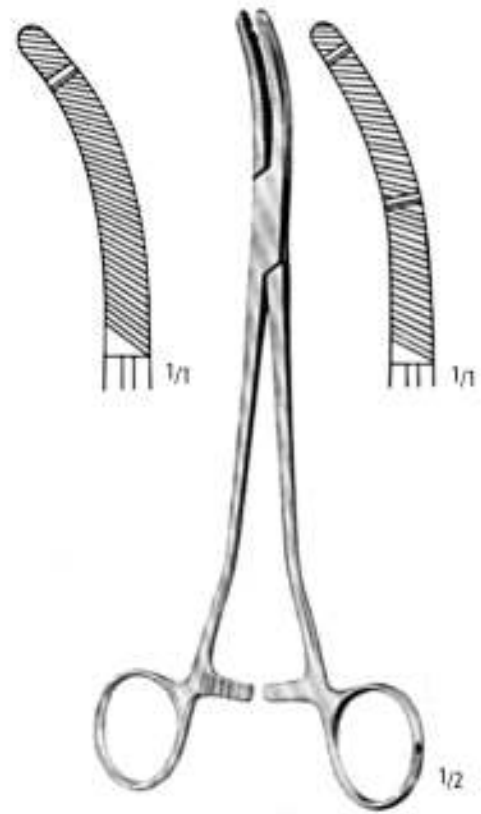

**HEANEY**

HM - 571 - 21	21,0 cm / 8 1/4"	HM - 572 - 21
HM - 571 - 23	23,0 cm / 9"	HM - 572 - 23

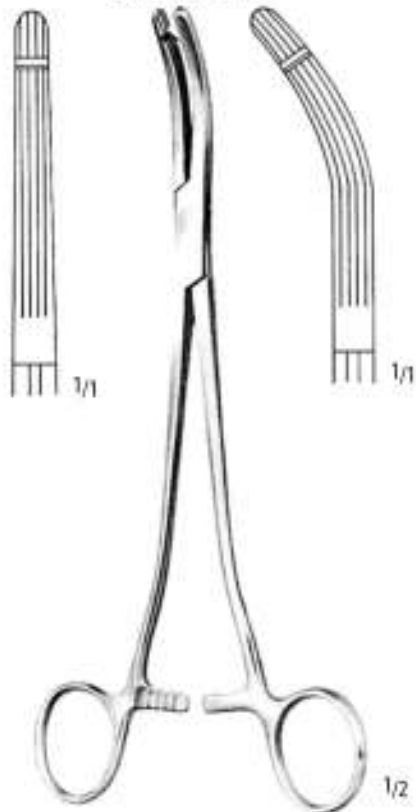

**HEANEY - BALLANTINE**

HM - 575 - 21 21,0 cm / 8 1/4" HM - 576 - 21



**HEANEY - KANTER**

HM - 577 - 21  
21,0 cm / 8 1/4"

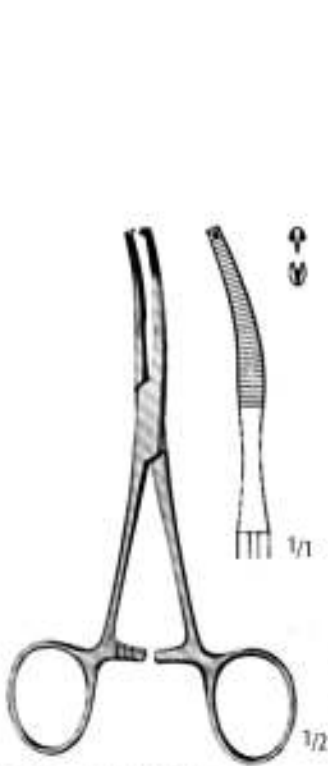

**BABY - MIKULICZ 1 : 2**  
HM - 700 - 14  
14,0 cm / 5 1/2"

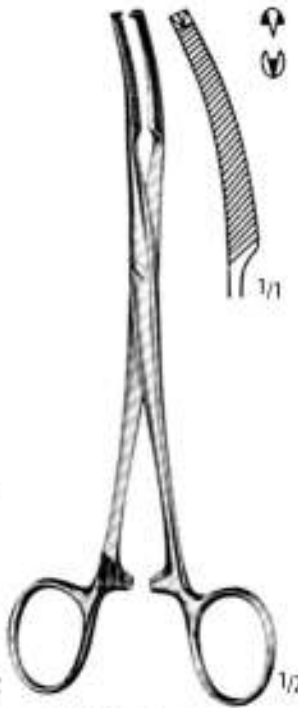

**MIKULICZ 1 : 2**  
HM - 701 - 18  
18,0 cm / 7"

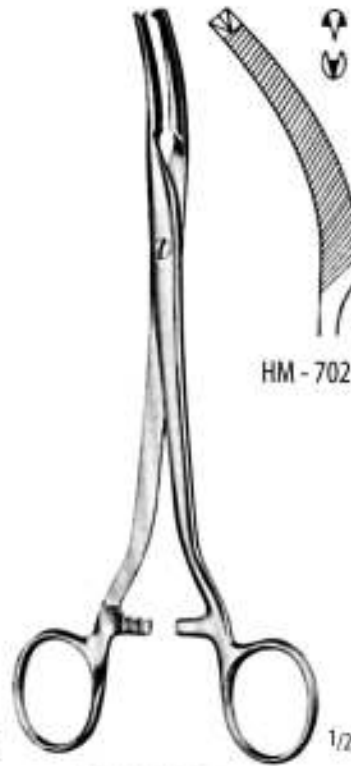

HM - 702 - 20



HM - 703 - 20

**MIKULICZ 1 : 2**  
20,0 cm / 8"

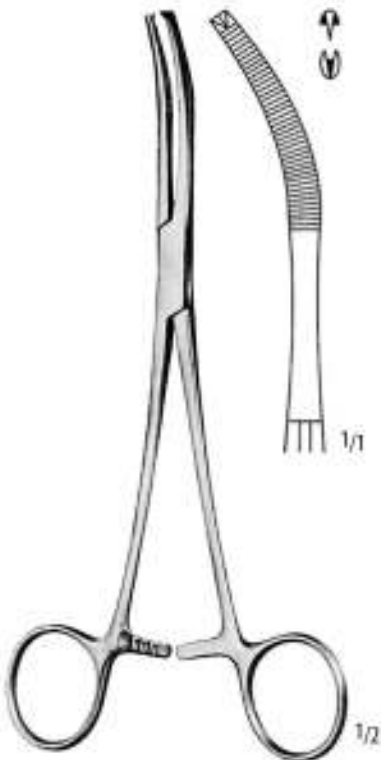

**MIKULICZ 1 : 2**  
HM - 704 - 20  
20,0 cm / 8"

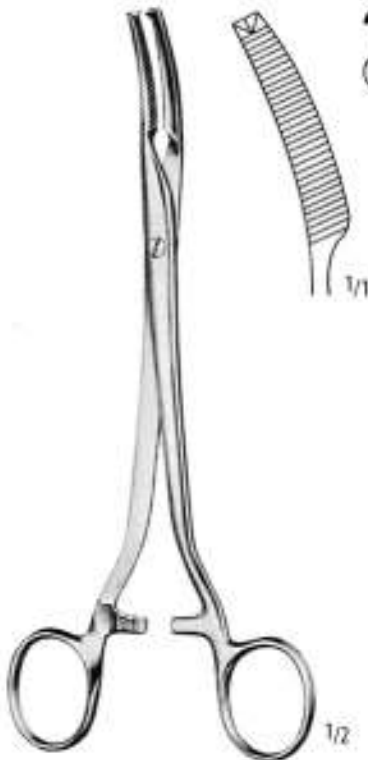

**MIKULICZ 1 : 2**  
HM - 705 - 20  
20,5 cm / 8"

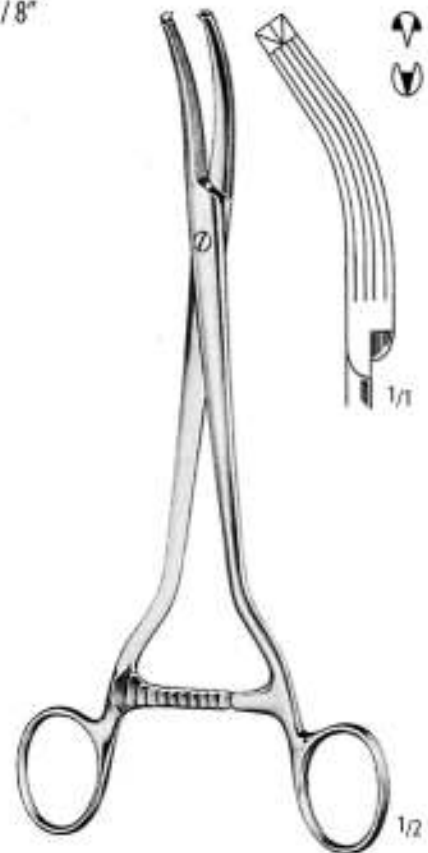

**MIKULICZ 1 : 2**  
HM - 706 - 23  
23,0 cm / 9"



11,0 cm / 4 1/2" HM - 860 - 00



**BACKHAUS**

- 8,0 cm / 3 1/4" HM - 860 - 08
- 11,0 cm / 4 1/2" HM - 860 - 11
- 13,0 cm / 5" HM - 860 - 13
- 15,0 cm / 6" HM - 860 - 15



**BALL & SOCKET**

- HM - 861 - 13
- 13,0 cm / 5"

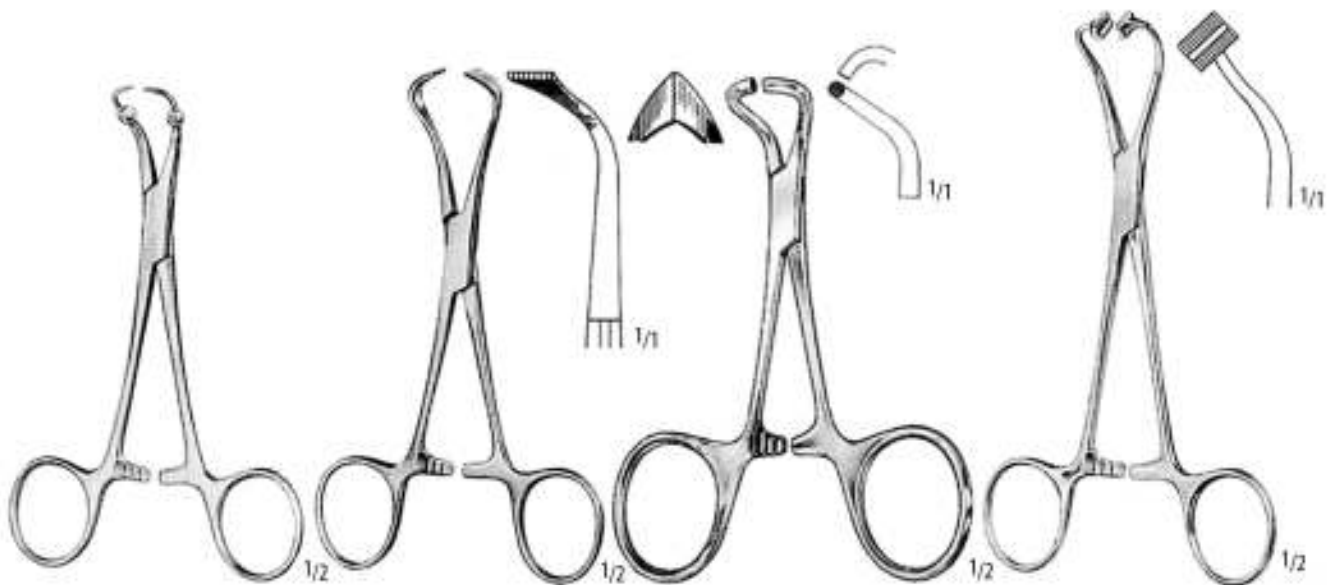

**ROEDER**

- 13,0 cm / 5" HM - 880 - 13
- 15,0 cm / 6" HM - 880 - 15

**LORNA**

- 10,0 cm / 4" HM - 881 - 10
- 13,0 cm / 5" HM - 881 - 13

**TOHOKU - JAPAN**

- 10,0 cm / 4" HM - 882 - 10
- 13,0 cm / 5" HM - 882 - 13

**PEERS**

- HM - 883 - 14
- 14,5 cm / 5 3/4"



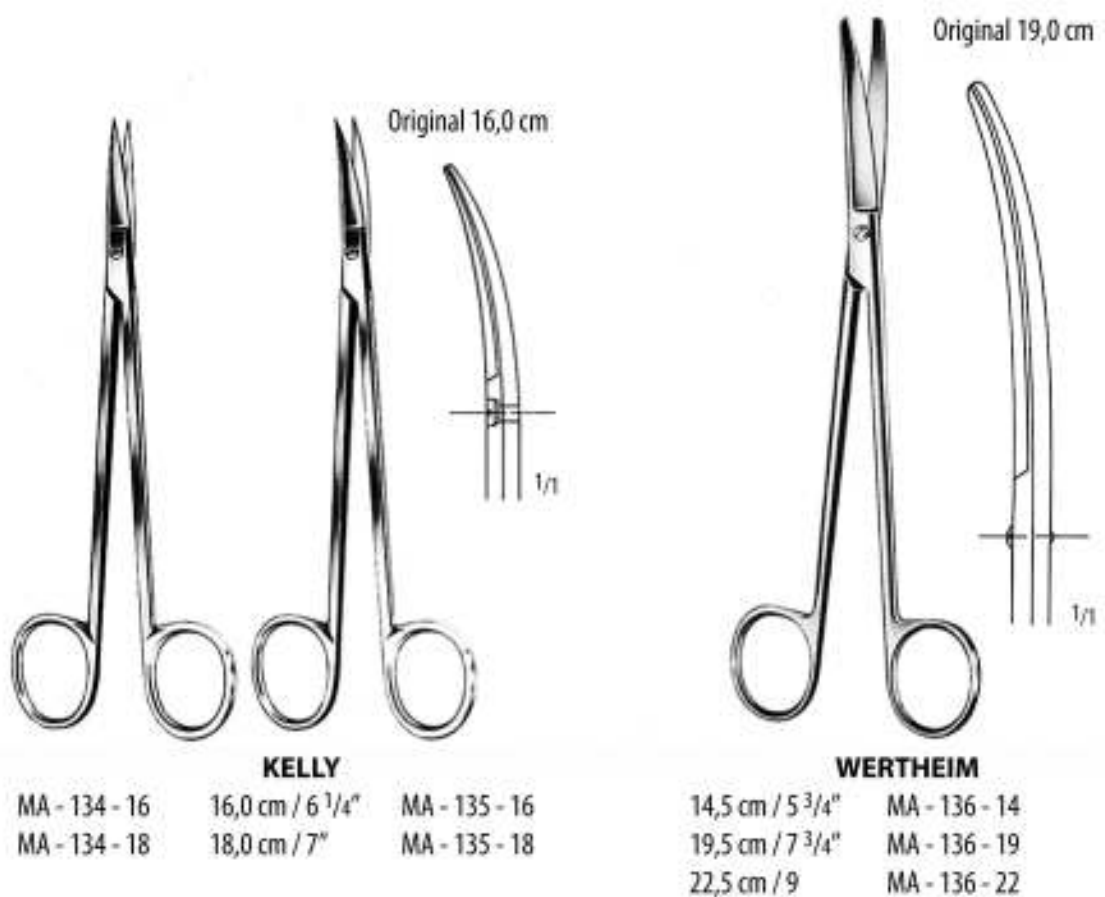
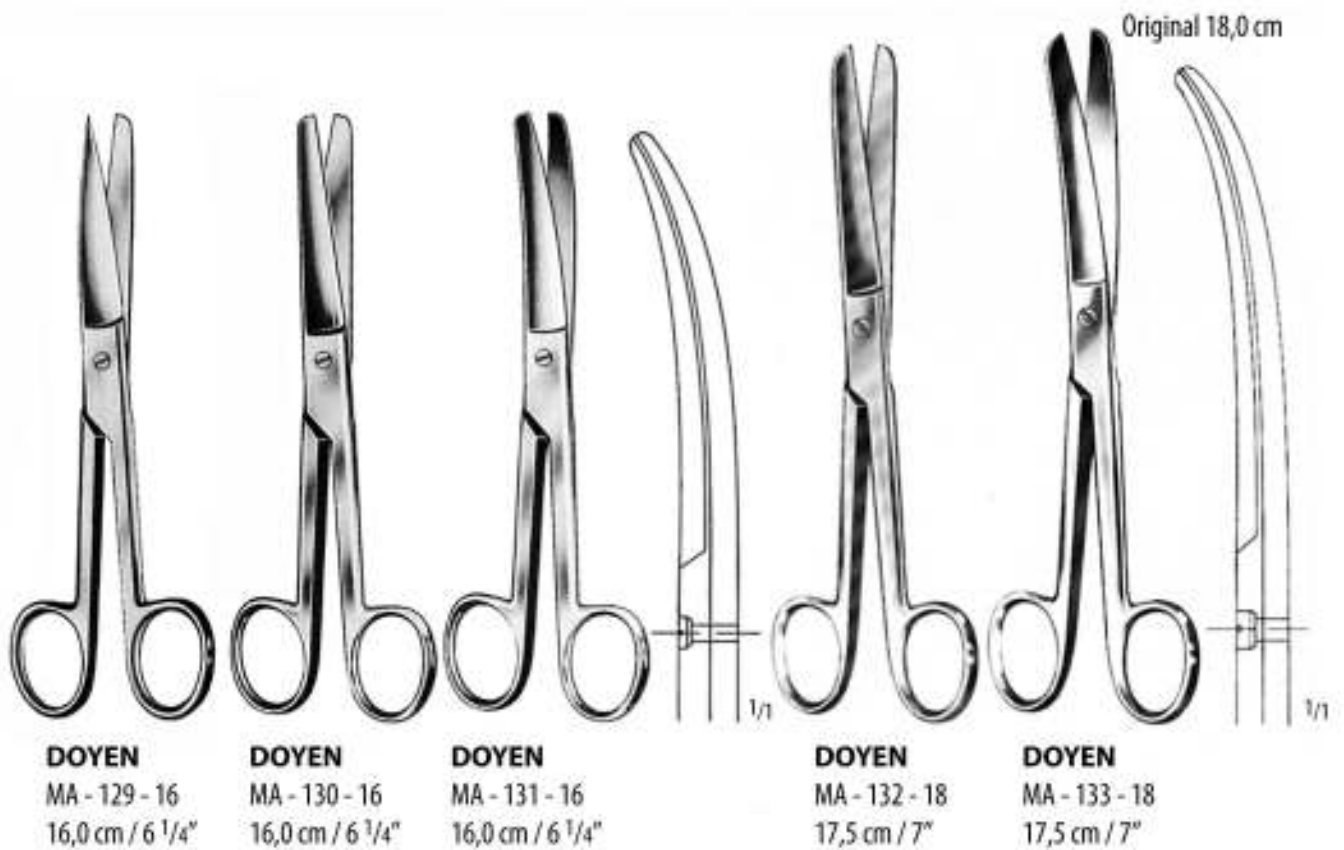

**METZENBAUM - DELICATE**

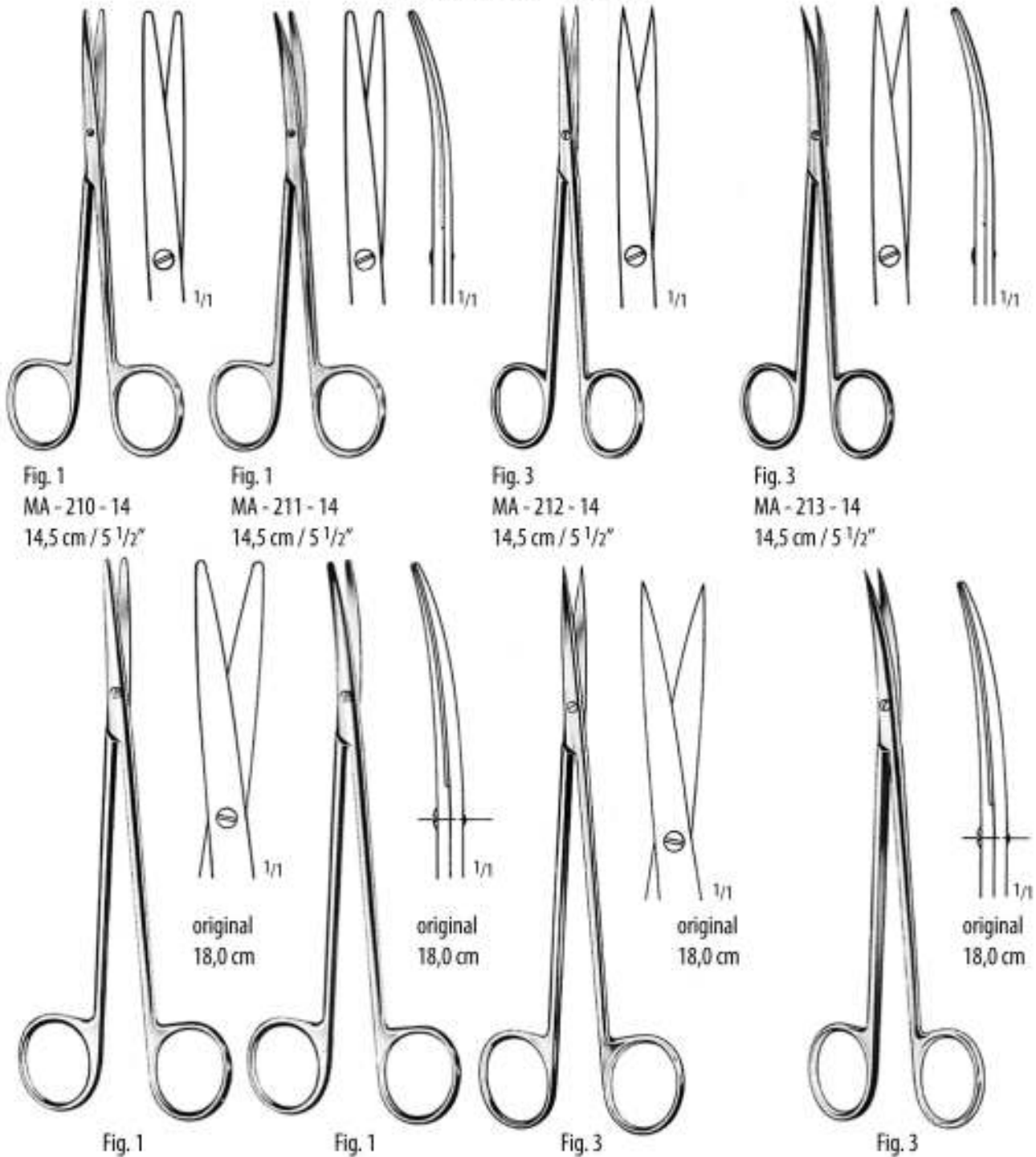

18,0 cm / 7"	MA - 214 - 18	MA - 215 - 18	MA - 216 - 18	MA - 217 - 18
20,0 cm / 8"	MA - 214 - 20	MA - 215 - 20	MA - 216 - 20	MA - 217 - 20
23,0 cm / 9"	MA - 214 - 23	MA - 215 - 23	MA - 216 - 23	MA - 217 - 23
25,0 cm / 10"	MA - 214 - 25	MA - 215 - 25	MA - 216 - 25	MA - 217 - 25
28,0 cm / 11"	MA - 214 - 28	MA - 215 - 28	MA - 216 - 28	MA - 217 - 28
30,0 cm / 12"	MA - 214 - 30	MA - 215 - 30	MA - 216 - 30	MA - 217 - 30



**BRAUN - STADLER**  
MA - 453 - 14  
14,0 cm / 5 1/2"



**BRAUN - STADLER**  
MA - 453 - 22  
22,0 cm / 8 3/4"



**WALDMANN**  
MA - 453 - 18  
18,0 cm / 7"



MA - 454 - 20  
20,0 cm / 8"



**MARBACH**  
MA - 455 - 15  
15,5 cm / 6"



**MOD. USA**  
MA - 456 - 10  
10,5 cm / 4"



**SCHUMACHER**  
MA - 457 - 16  
16,0 cm / 6 1/4"



**BUSCH**  
13,0 cm / 5" MA - 458 - 13  
16,0 cm / 6 1/4" MA - 458 - 16



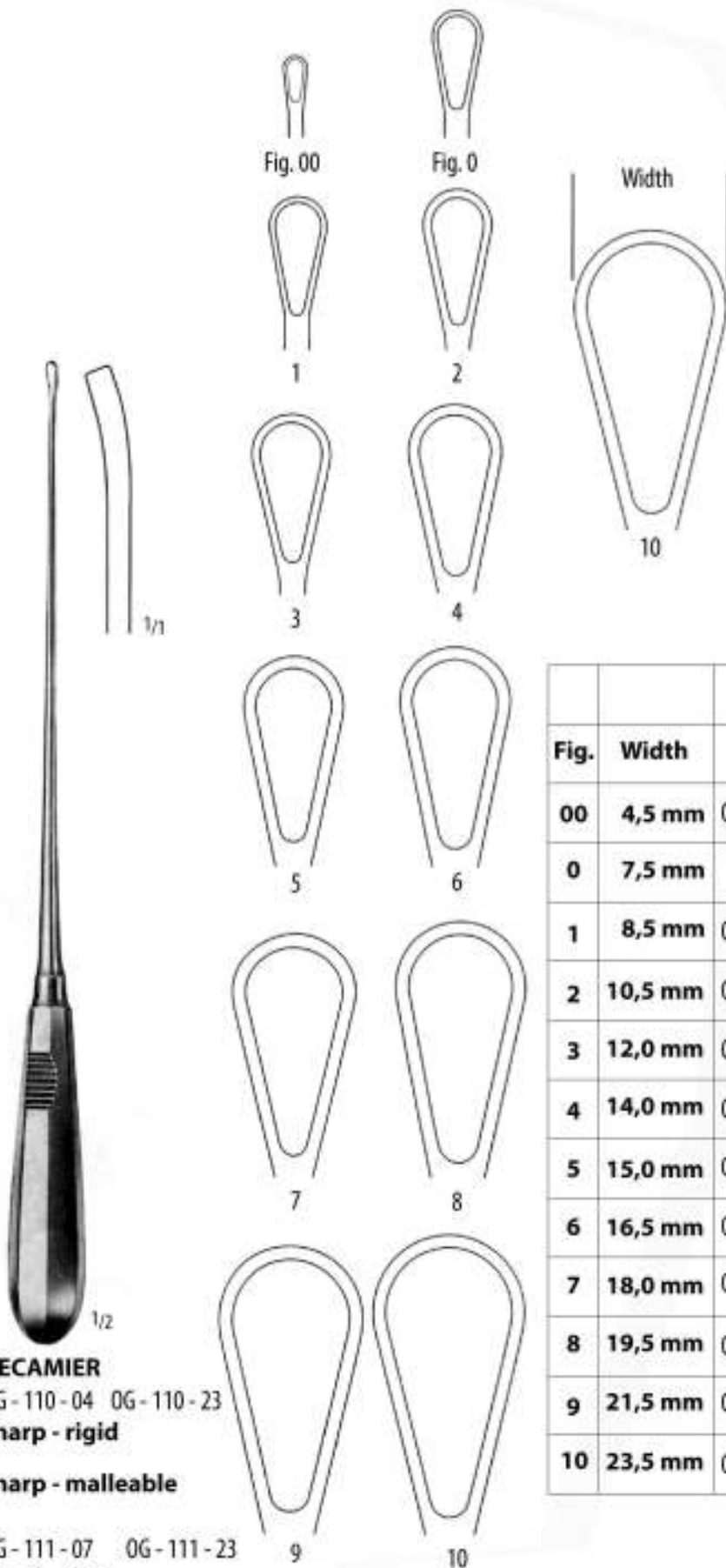

**RECAMIER**  
OG - 110 - 04 OG - 110 - 23  
**sharp - rigid**

**sharp - malleable**

OG - 111 - 07 OG - 111 - 23  
**blunt - rigid**  
max. 300 mm, 12"

Fig.	Width	sharp		blunt
		rigid	malleable	rigid
00	4,5 mm	OG - 110 - 04		
0	7,5 mm		OG - 111 - 07	OG - 110 - 07
1	8,5 mm	OG - 110 - 08	OG - 111 - 08	
2	10,5 mm	OG - 110 - 10	OG - 111 - 10	
3	12,0 mm	OG - 110 - 12	OG - 111 - 12	
4	14,0 mm	OG - 110 - 14	OG - 111 - 14	
5	15,0 mm	OG - 110 - 15	OG - 111 - 15	
6	16,5 mm	OG - 110 - 16	OG - 111 - 16	
7	18,0 mm	OG - 110 - 18	OG - 111 - 18	
8	19,5 mm	OG - 110 - 19	OG - 111 - 19	
9	21,5 mm	OG - 110 - 21	OG - 111 - 21	
10	23,5 mm	OG - 110 - 23	OG - 111 - 23	



1/2

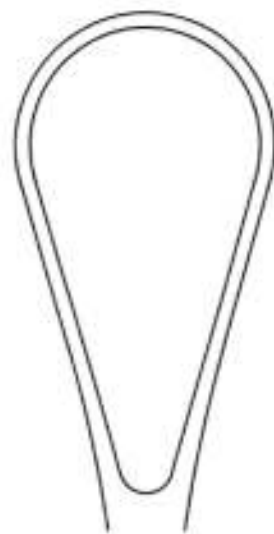

Fig. 1

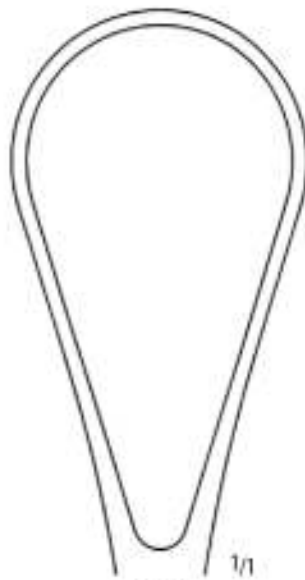

Fig. 2

1/1

**RECAMIER**  
 OG - 200 - 34    OG - 200 - 29  
**blunt - rigid**  
 max. 360 mm, 14 <sup>3</sup>/<sub>8</sub>"

Fig.	Width	blunt rigid
1	34,5 mm	OG - 200 - 34
2	39,5 mm	OG - 200 - 39



1/2



Fig. 1



Fig. 2



1/1

Fig. 3

**BUMM**  
 OG - 201 - 23    OG - 201 - 28    sharp - malleable  
 OG - 202 - 23    OG - 202 - 28    blunt - malleable  
 max. 310 mm, 12 <sup>3</sup>/<sub>8</sub>"

Fig.	Width	sharp malleable	blunt malleable
1	23,5 mm	OG - 201 - 23	OG - 202 - 23
2	26,0 mm		OG - 202 - 26
3	28,5 mm	OG - 201 - 28	OG - 202 - 28

**DESCHAMPS**

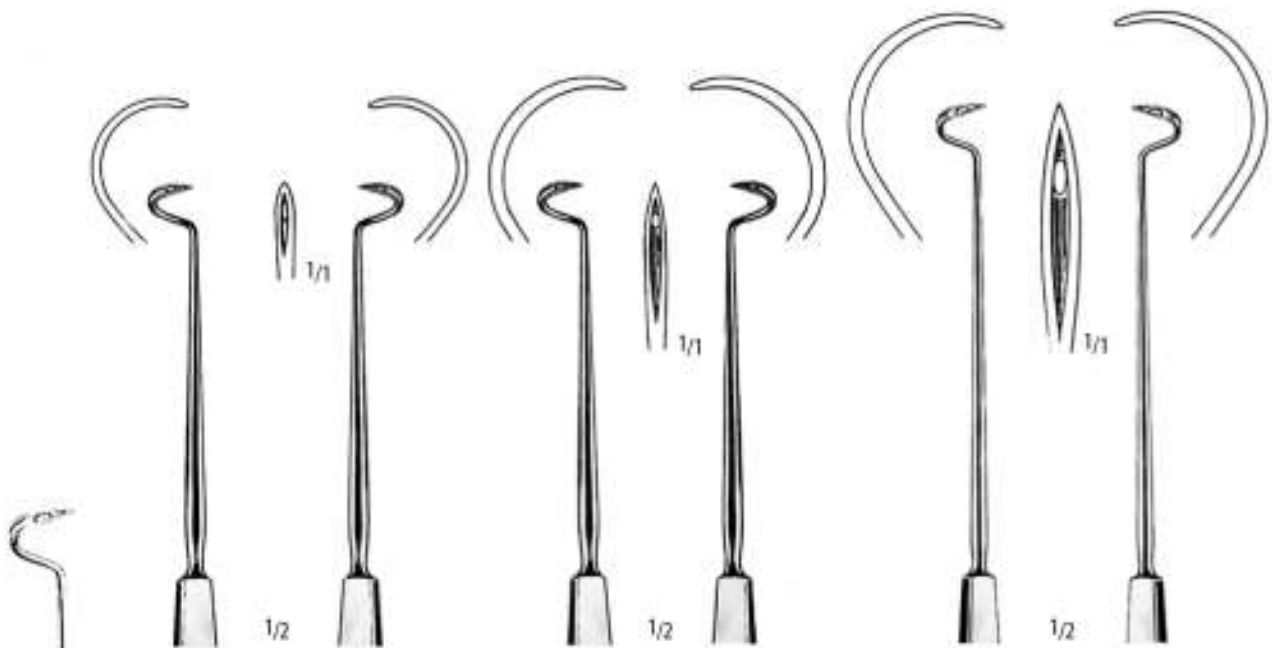

pointed

20,0 cm/8"	PO - 160 - 20	PO - 161 - 20	PO - 162 - 20	PO - 163 - 20		
21,0 cm/8 <sup>1</sup> / <sub>4</sub> "					PO - 164 - 21	PO - 165 - 21
27,0 cm/10 <sup>1</sup> / <sub>2</sub> "					PO - 164 - 27	PO - 165 - 27

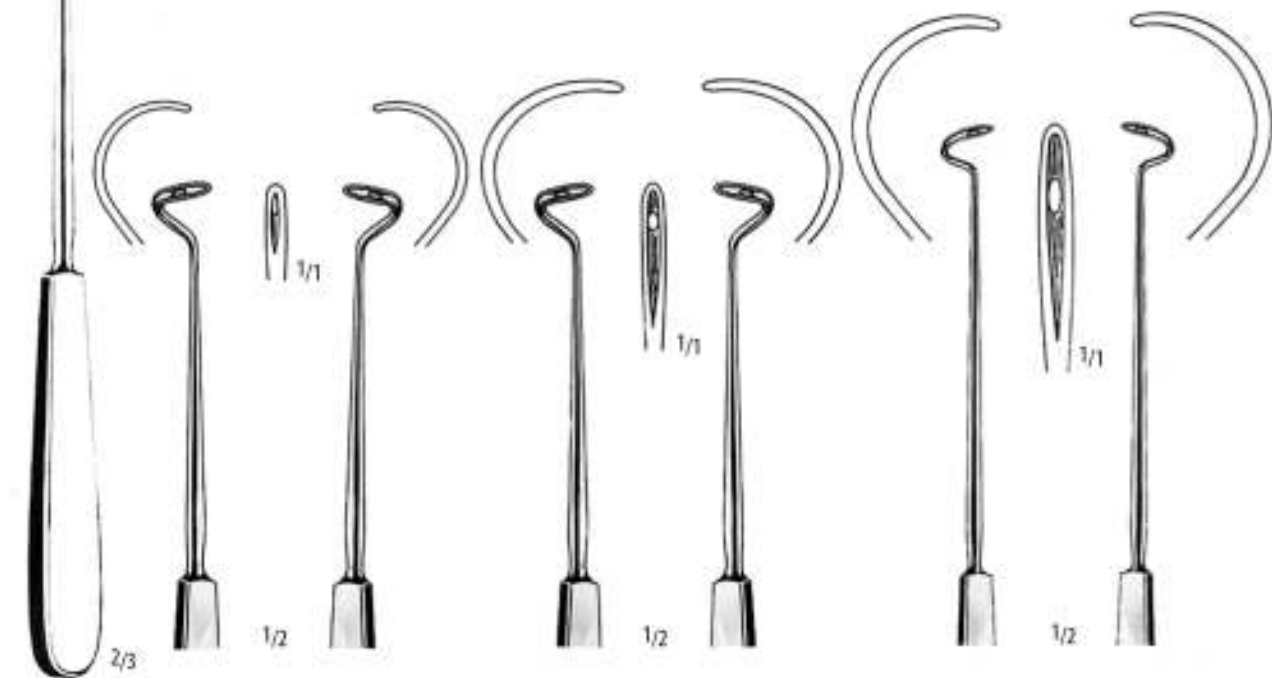

**DESCHAMPS**





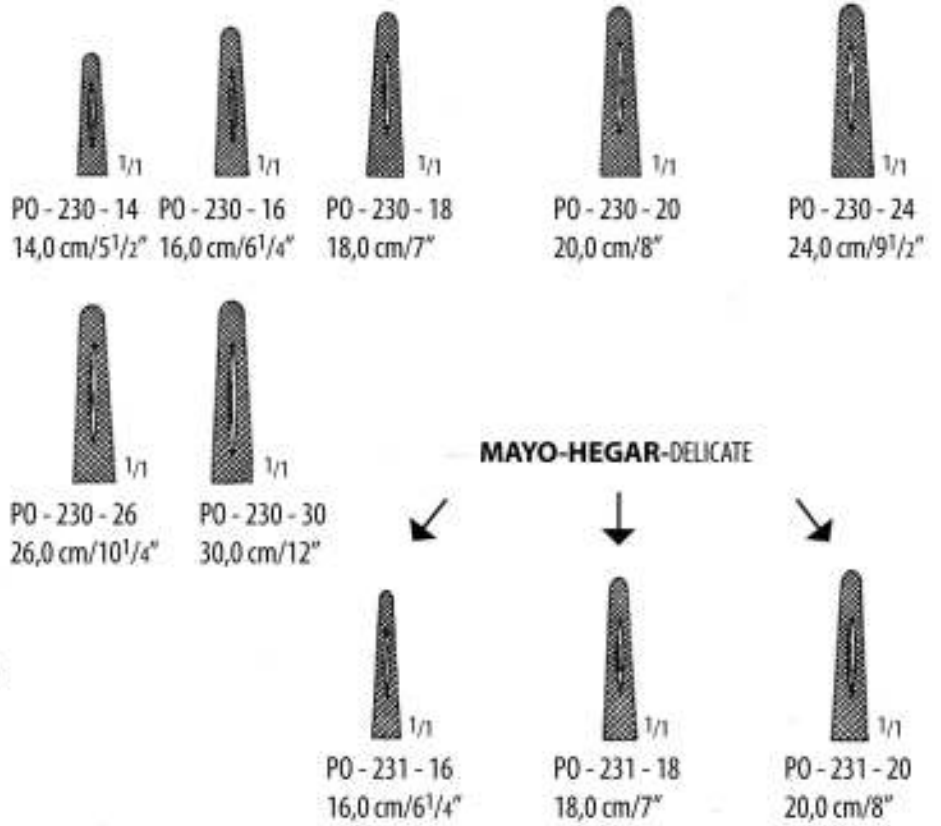

blunt

20,0 cm/8"	PO - 166 - 20	PO - 167 - 20	PO - 168 - 20	PO - 169 - 20		
21,0 cm/8 <sup>1</sup> / <sub>4</sub> "					PO - 170 - 21	PO - 171 - 21
27,0 cm/10 <sup>1</sup> / <sub>2</sub> "					PO - 170 - 27	PO - 171 - 27







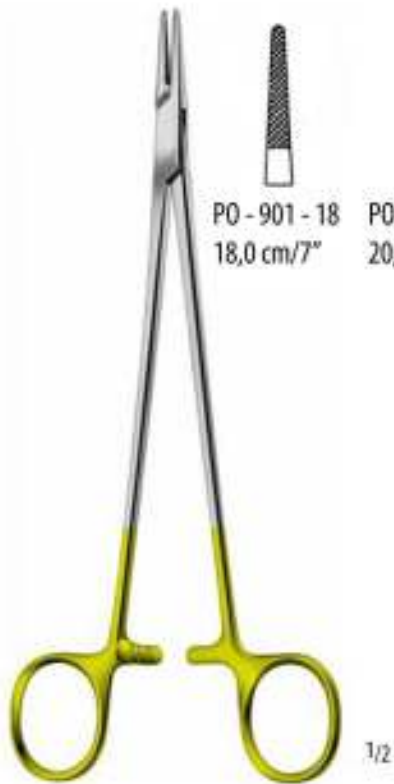

**MAYO-HEGAR**

				
PO - 900 - 14 14,0 cm/5 <sup>1</sup> / <sub>2</sub> "	PO - 900 - 16 16,0 cm/6 <sup>1</sup> / <sub>4</sub> "	PO - 900 - 18 18,0 cm/7"	PO - 900 - 20 20,0 cm/8"	PO - 900 - 24 24,0 cm/9 <sup>1</sup> / <sub>2</sub> "
				
			PO - 900 - 26 26,0 cm/10 <sup>1</sup> / <sub>4</sub> "	PO - 900 - 30 30,0 cm/12"



**DE BAKEY  
(MAYO-HEGAR-DELICATE)**

				
PO - 901 - 18 18,0 cm/7"	PO - 901 - 20 20,0 cm/8"	PO - 901 - 23 23,0 cm/9"	PO - 901 - 26 26,0 cm/10 <sup>1</sup> / <sub>4</sub> "	PO - 901 - 31 31,0 cm/12 <sup>1</sup> / <sub>4</sub> "



**MILLIN**  
**KA 658-29**  
29 cm

Foreign Body Forceps



**MATHIEU**  
**RG 550-01**  
length of shaft 28 cm

ø 4,0 mm



**SIMS**  
**SO 600-33**  
34 cm, 13 1/2"  
graduated in inch,  
malleable, silver-plated

ø 4,0 mm



**SIMS**  
**SO 601-33**  
34 cm, 13 1/2"  
graduated in centimeters,  
malleable, silver-plated

ø 4,0 mm



**SIMS**  
**SO 602-33**  
34 cm, 13 1/2"  
graduated in centimeters,  
malleable, 18/8 steel

ø 4,0 mm



**SIMPSON**  
**SO 603-33**  
34 cm, 13 1/2"  
graduated in centimeters,  
malleable, silver-plated

ø 4,0 mm



**VALLEIX**  
**SO 604-29**  
29 cm, 11 1/2"  
graduated in centimeters, with  
sides, malleable, chromium plated



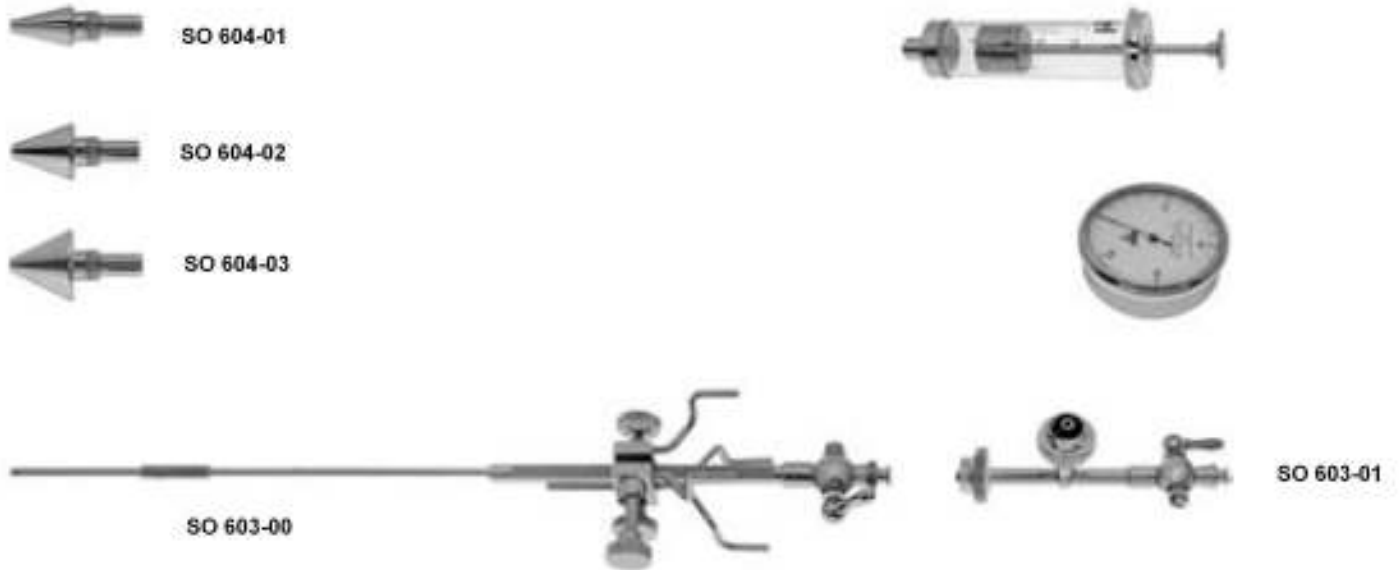

**SCHULTZE**  
**SO 603-25**

Salpingograph for diagnosis and treatment of sterility, for injections of Lipiodol into the uterus and the Fallopian tubes, for intra-uterine insufflation and for diagnosis by x-rays, complete, consisting of

- 1 Manometer with luminous dial
- 1 Connecting-piece with stopcock
- 1 Uterine cannula with stopcock
- 1 Interchangeable occlusive nozzle, small
- 1 Interchangeable occlusive nozzle, medium
- 1 Interchangeable occlusive nozzle, large
- 1 Record syringe 10 ccm, with LUER-LOCK mount
- 1 Wooden Case

**SCHULTZE**  
**SO 603-26**

Salpingograph - without manometer - for diagnosis and treatment of sterility, for injections of Lipiodol into the uterus and the Fallopian tubes, for intra-uterine insufflation and for diagnosis by x-rays, complete, consisting of

- 1 Uterine cannula with stopcock
- 1 Interchangeable occlusive nozzle, small
- 1 Interchangeable occlusive nozzle, medium
- 1 Interchangeable occlusive nozzle, large
- 1 Record syringe 10 ccm, with LUER-LOCK mount
- 1 Wooden Case





Char.  
(French)

<b>SP 200-08</b>	8
<b>SP 200-10</b>	10
<b>SP 200-12</b>	12
<b>SP 200-14</b>	14
<b>SP 200-16</b>	16
<b>SP 200-18</b>	18
<b>SP 200-20</b>	20

15 cm, 6"

Metal catheters for women



**DOYEN**  
**SP 150-15**  
17 cm, 6<sup>3</sup>/<sub>4</sub>"

**Myomheber ø 20 mm**  
Myoma screw ø 20 mm  
Tirabuzón para mioma ø 20 mm  
Tracteur pour fibrome ø 20 mm  
Succhiello per fibroma ø 20 mm



**DOYEN**  
**SP 151-15**  
17 cm, 6<sup>3</sup>/<sub>4</sub>"

**Myomheber ø 29 mm**  
Myoma screw ø 29 mm  
Tirabuzón para mioma ø 29 mm  
Tracteur pour fibrome ø 29 mm  
Succhiello per fibroma ø 29 mm



**COLLIN**  
 SP - 250 - 00  
 53 X 10 mm  
 for children



**COLLIN**  
 SP - 250 - 01  
 95/85 X 18 mm  
 for virgins

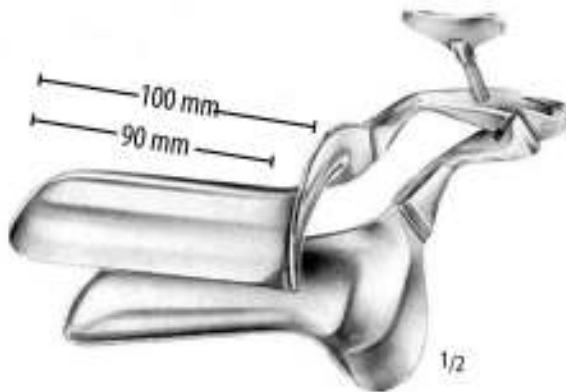

**COLLIN**  
 SP - 250 - 28 100/90 mm 28 mm  
 SP - 250 - 32 100/90 mm 32 mm  
 SP - 250 - 35 105/95 mm 35 mm  
 SP - 250 - 40 115/105 mm 40 mm  
 Total length/working length width



mm	KALLMORGEN
70x40	SP 286-16
90x40	SP 287-16

Speculum



mm	KALLMORGEN
70x33	SP 286-26
90x33	SP 287-26

Retractor



KALLMORGEN	SET
SP 286-00	70x40
SP 287-00	90x40



### HEGAR

With very conical point

SP - 500 - 01 - SP - 501 - 17

185 mm, 7 1/4"

SP - 500 - 01	1 mm	SP - 500 - 14	14 mm	SP - 501 - 01	1 1/2" mm	SP - 501 - 14	14 1/4" mm
SP - 500 - 02	2 mm	SP - 500 - 15	15 mm	SP - 501 - 02	2 1/2" mm	SP - 501 - 15	15 1/4" mm
SP - 500 - 03	3 mm	SP - 500 - 16	16 mm	SP - 501 - 03	3 1/2" mm	SP - 501 - 16	16 1/4" mm
SP - 500 - 04	4 mm	SP - 500 - 17	17 mm	SP - 501 - 04	4 1/2" mm	SP - 501 - 17	17 1/4" mm
SP - 500 - 05	5 mm	SP - 500 - 18	18 mm	SP - 501 - 05	5 1/2" mm		
SP - 500 - 06	6 mm	SP - 500 - 19	19 mm	SP - 501 - 06	6 1/2" mm		
SP - 500 - 07	7 mm	SP - 500 - 20	20 mm	SP - 501 - 07	7 1/2" mm		
SP - 500 - 08	8 mm	SP - 500 - 21	21 mm	SP - 501 - 08	8 1/2" mm		
SP - 500 - 09	9 mm	SP - 500 - 22	22 mm	SP - 501 - 09	9 1/2" mm		
SP - 500 - 10	10 mm	SP - 500 - 23	23 mm	SP - 501 - 10	10 1/2" mm		
SP - 500 - 11	11 mm	SP - 500 - 24	24 mm	SP - 501 - 11	11 1/2" mm		
SP - 500 - 12	12 mm	SP - 500 - 25	25 mm	SP - 501 - 12	12 1/2" mm		
SP - 500 - 13	13 mm	SP - 500 - 26	26 mm	SP - 501 - 13	13 1/2" mm		

### HEGAR

SP - 506 - 02 - SP - 506 - 18

205 mm, 8"

SP - 506 - 02	1+2 mm
SP - 506 - 04	3+4 mm
SP - 506 - 06	5+6 mm
SP - 506 - 08	7+8 mm
SP - 506 - 10	9+10 mm
SP - 506 - 12	11+12 mm
SP - 506 - 14	13+14 mm
SP - 506 - 16	15+16 mm
SP - 506 - 18	17+18 mm

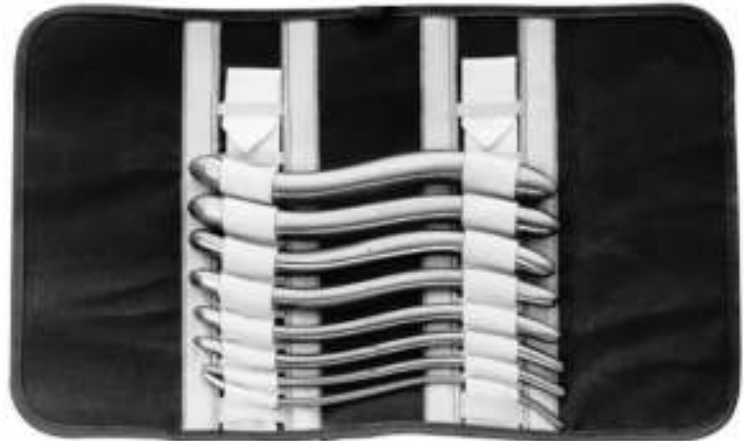

### OG 500-04/17

Uterine Dilator Set  
Canvas Roll with 8 dilators  
(SP 506-04 , SP 506-18)



**BRAUN**  
TN - 101 - 25  
250 mm, 10"



**COLLIN-POZZI**  
TN - 102 - 25  
250 mm, 10"

**STANDARD**



**SCHRÖDER**  
TN - 103 - 25  
250 mm, 10"



**SCHRÖDER**  
TN - 104 - 25  
250 mm, 10"

#### Gallipott

TS 102-0103	40 x 30 mm	30 ml
TS 102-0104	60 x 35 mm	60 ml
TS 102-0105	70 x 40 mm	90 ml
TS 102-0106	75 x 45 mm	120 ml
TS 102-0107	85 x 50 mm	180 ml
TS 102-0108	90 x 55 mm	240 ml
TS 102-0109	105 x 60 mm	360 ml
TS 102-0110	122 x 56 mm	480 ml
TS 102-0113	122 x 63 mm	540 ml
TS 102-0115	143 x 58 mm	660 ml
TS 102-0118	143 x 70 mm	840 ml
TS 102-0120	163 x 58 mm	900 ml
TS 102-0125	163 x 68 mm	1080 ml



#### Lotion Bowls

TS 101-0103	Ø 46 x 29 mm	30 ml
TS 101-0104	Ø 56 x 32 mm	50 ml
TS 101-0105	Ø 66 x 36 mm	90 ml
TS 101-0106	Ø 76 x 41 mm	120 ml
TS 101-0107	Ø 88 x 46 mm	170 ml
TS 101-0108	Ø 95 x 51 mm	250 ml
TS 101-0109	Ø 107 x 56 mm	325 ml
TS 101-0110	Ø 128 x 60 mm	450 ml
TS 101-0113	Ø 139 x 65 mm	600 ml
TS 101-0115	Ø 158 x 75 mm	950 ml
TS 101-0118	Ø 185 x 81 mm	1400 ml
TS 101-0120	Ø 208 x 84 mm	1940 ml
TS 101-0125	Ø 258 x 92 mm	3200 ml



#### Lotion Bowl with spout

TS 100-0103	Ø 46 mm	30 ml
TS 100-0104	Ø 56 mm	50 ml
TS 100-0105	Ø 66 mm	90 ml
TS 100-0106	Ø 76 mm	120 ml
TS 100-0107	Ø 88 mm	170 ml
TS 100-0108	Ø 95 mm	250 ml
TS 100-0109	Ø 107 mm	325 ml
TS 100-0110	Ø 128 mm	450 ml
TS 100-0113	Ø 139 mm	600 ml
TS 100-0115	Ø 158 mm	940 ml
TS 100-0118	Ø 185 mm	1390 ml
TS 100-0120	Ø 208 mm	1940 ml
TS 100-0125	Ø 258 mm	3240 ml

