

idol
cerraahi aletler

GENEL KATALOG



İdol Cerrahi Aletler

Operasyon anatomisine uygun cerrahi el aletleri üreten, çeşitli operasyonlar için hazırladığı özel tasarımlarla sektörün güvenini kazanan İdol Cerrahi Aletler, 2005'ten bu yana sağlık alanında kaliteyi temsil etmektedir.

Beyin cerrahisinden kalp damar cerrahisine, kulak burun boğaz cerrahisinden ortopedik cerrahiye kadar yaklaşık 7.000 farklı model cerrahi el aletiyle sektörün ihtiyaçlarını maksimum düzeyde karşılayabilmek için çalışmakta ve sterilizasyon takip sistemine yönelik yazılım programları geliştirmektedir.

√ İDOL; sürekli yeni ürünler geliştirerek, cerrahi ve hastane süreçlerini iyileştirmek, sağlık profesyonelleri ve hastalar için güvenliği artırmak için çalışmaktadır.

√ Ürünlerimiz kullanıcıların ve pazarın ihtiyaçlarını karşılamak üzere tasarlanmıştır.

√ Sizin fikirleriniz bizim için çok değerlidir. Fikirleriniz kadar geri bildirimleriniz de çok değerlidir.

√ Eğer yeni ürün veya ürün geliştirmeleri için herhangi bir öneriniz veya fikriniz varsa, bize yazın lütfen; fikirleriniz mutlak gizlilik ile korunacaktır, tüm hakları öneri yapan kişiye aittir.





complete with
Suction tube
+ cannula 0,4 mm
+ cannula 0,6 mm
+ cannula 0,8 mm

FRAZIER

6 Charr. AS - 100 - 06
8 Charr. AS - 100 - 08
10 Charr. AS - 100 - 10
12 Charr. AS - 100 - 12

PLESTER

1,5 mm AS - 200 - 15
2,0 mm AS - 200 - 20
2,5 mm AS - 200 - 25
3,0 mm AS - 200 - 30

FRAZIER

2 mm AS - 201 - 02
3 mm AS - 201 - 03
4 mm AS - 201 - 04
5 mm AS - 201 - 05

WULLSTEIN

MICRO
AS - 400 - 04
AS - 400 - 06
AS - 400 - 08



BS - 200 - 03
No. 3



BS - 201 - 03
No. 3



BS - 201 - 04
No. 4



BS - 202 - 13
No. 3L



BS - 203 - 14
No. 4L



BS - 210 - 07
No. 7 ^{1/1}



BS - 211 - 07
No. 7K ^{1/1}



BS - 212 - 16 ^{1/1}



COLLIN
BS - 213 - 08
No. 8 ^{1/1}

hollow



COLLIN
BS - 214 - 09
No. 9 ^{1/1}



17 cm / 6³/₄"

1/1



BS - 250 - 01
Fig. 1



BS - 250 - 03
Fig. 3



BS - 250 - 05
Fig. 5



BS - 250 - 07
Fig. 7



BS - 250 - 09
Fig. 9



BS - 250 - 10
Fig. 10



BS - 250 - 12
Fig. 12



BS - 250 - 14
Fig. 14



BS - 250 - 16
Fig. 16



BS - 250 - 18
Fig. 18

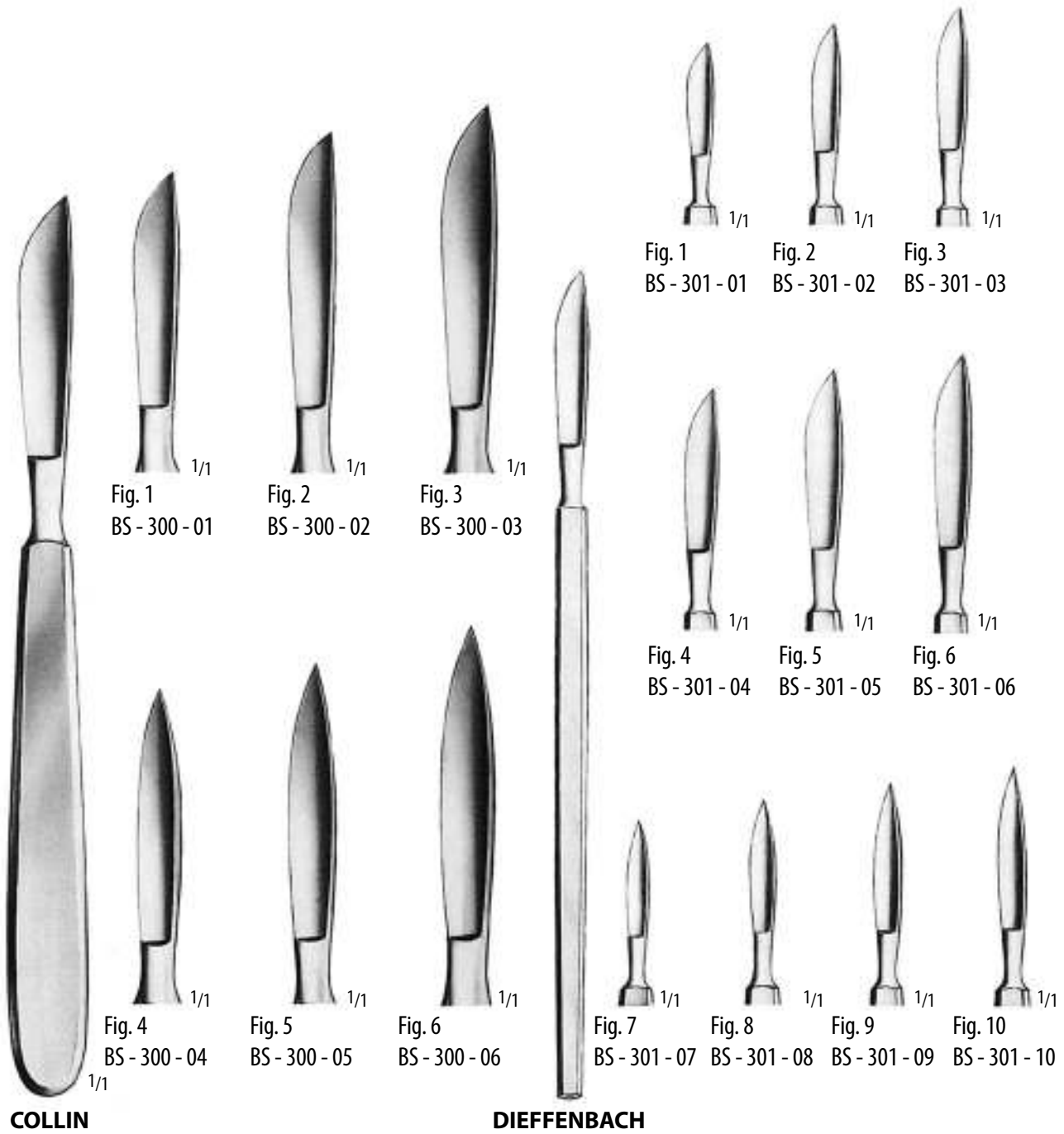



DIEFFENBACH



Fig. 1
BS-302-01



Fig. 2
BS-302-02



Fig. 3
BS-302-03



Fig. 4
BS-302-04



Fig. 5
BS-302-05



Fig. 6
BS-302-06



Fig. 7
BS-302-07



Fig. 8
BS-302-08



Fig. 9
BS-302-09



Fig. 15
BS-302-15



Fig. 16
BS-302-16



lengths of blades		COLLIN	CATLIN	LISTON	LANGENBECK
cm	in.				
12,0	4 ³ / ₄				
13,0	5	BS - 100 - 13			
15,0	6				
16,0	6 ¹ / ₄	BS - 100 - 16	BS - 101 - 16		
17,0	6 ³ / ₄			BS - 103 - 17	
19,0	7 1/2	BS - 100 - 19	BS - 102 - 19		
20,0	8			BS - 103 - 20	
22,0	8 ³ / ₄	BS - 100 - 22	BS - 102 - 22	BS - 103 - 22	
28,0	11 ³ / ₄	BS - 100 - 28			

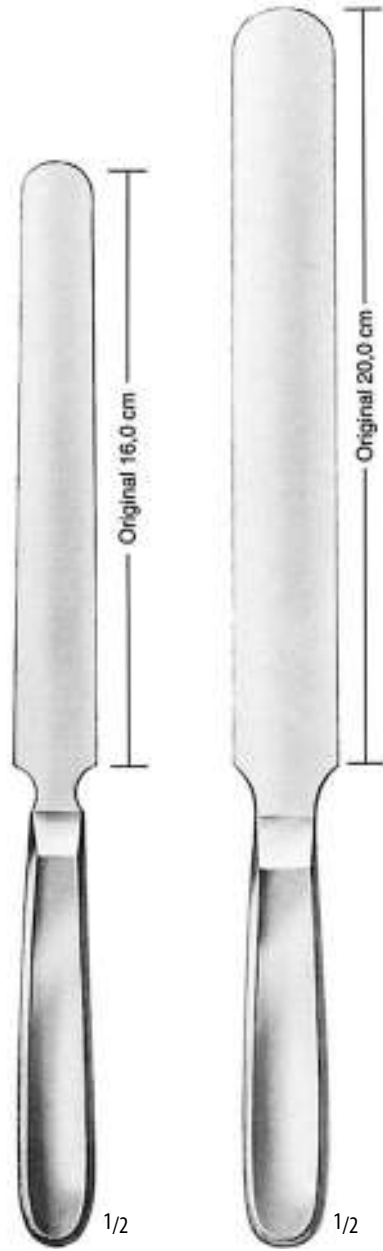

VIRCHOW
BS - 150 - 16

VIRCHOW
BS - 150 - 20



1/1

DIEFFENBACH

BS - 151 - 13

13,0 cm/5"



1/1

DIEFFENBACH

BS - 152 - 13

13,0 cm/5"



2/3

SIMON

23,5 cm/9 1/2"



1/1

Fig. 1

BS - 155 - 01



1/1

Fig. 2

BS - 155 - 02



1/1

Fig. 3

BS - 155 - 03



1/1

Fig. 4

BS - 155 - 04



THIERSCH
BS - 160 - 20
20,0 cm/8"



REHN
BS - 161 - 25
25,0 cm/10"



SCHINK
BS - 162 - 30
30,0 cm/12"



1/3
BS - 162 - 01

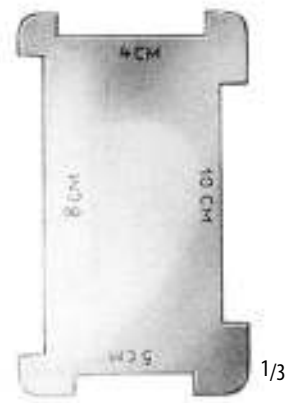

1/3
BS - 162 - 02

POLITZER

BS - 500 - 16
160 mm, 6 1/4"



LUCAE

BS - 501 - 16
Tympanum perforator, bayonet-shaped, for children
160 mm, 6 1/4"



BS - 501 - 19
Tympanum perforator, bayonet-shaped, for adults
190 mm, 7 1/2"



BS - 501 - 18
Myringotome perforator, bayonet-shaped, for adults
180 mm, 7"



POLITZER

BS - 502 - 16
Tympanum perforator, angled myringotome
160 mm, 6 1/4"



AGNEW (POLITZER)

BS - 503 - 17
Myringotome angled
175 mm, 7"



BS - 504 - 17
Universal - Myringotome, adjustable blade, reversing into handle
170 mm, 6 1/4"



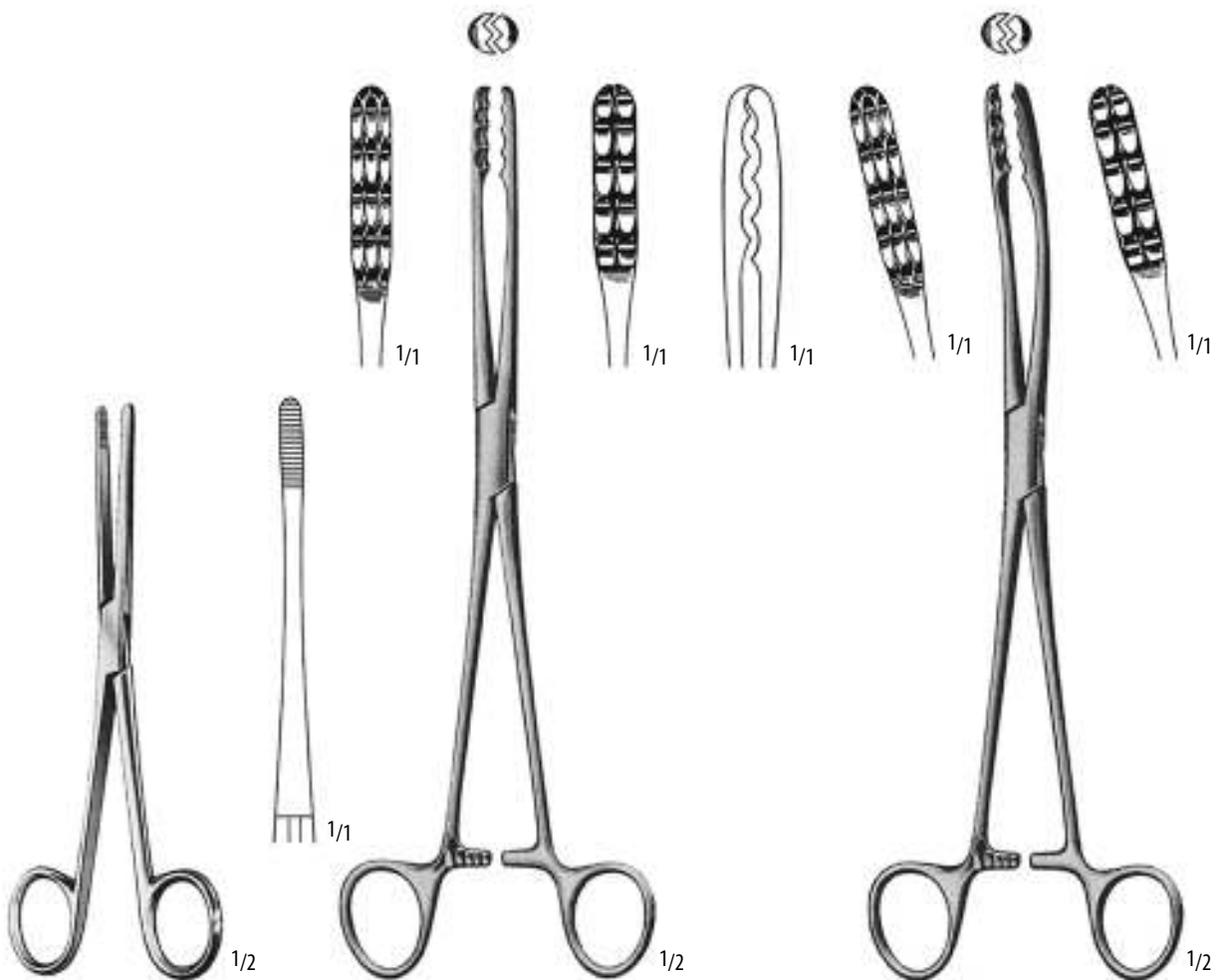

LISTER
 13,0 cm/5 1/4" CM - 200 - 13
 16,0 cm/6 1/4" CM - 200 - 16
 18,0 cm/7" CM - 200 - 18

ULRICH
 CM - 201 - 22
 CM - 201 - 25
 22,0 cm/8 3/4"
 25,0 cm/10"

ULRICH
 CM - 202 - 22
 CM - 203 - 25



GROSS - MAIER

CM - 205 - 20
CM - 205 - 22
CM - 205 - 25
CM - 205 - 27

20,0 cm/8"
22,0 cm/8 3/4"
25,0 cm/10"
27,0 cm/10 3/4"

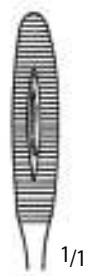

GROSS - MAIER

CM - 206 - 20
CM - 206 - 22
CM - 206 - 25
CM - 206 - 27





FLETCHER
CM - 207 - 24
24,0 cm/9 1/2"

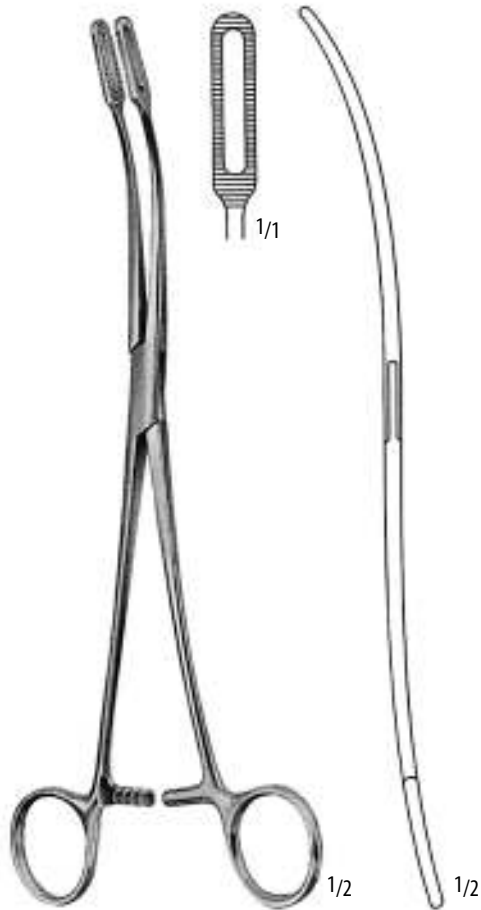

FLETCHER
CM - 208 - 24
24,0 cm/9 1/2"

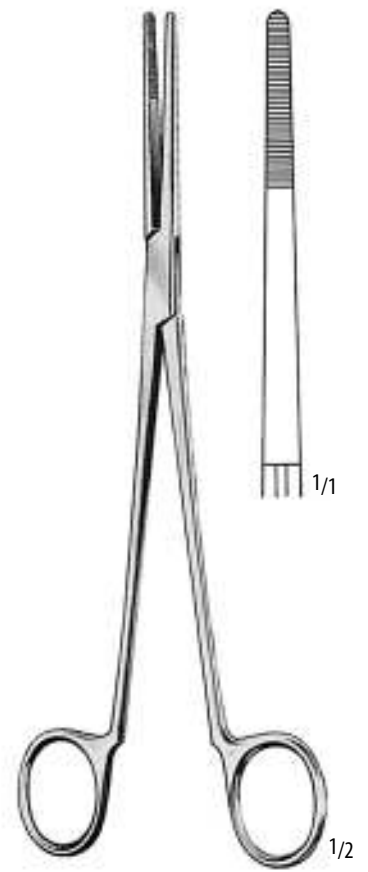

WESTERMARK
CM - 209 - 23
23,0 cm/9"

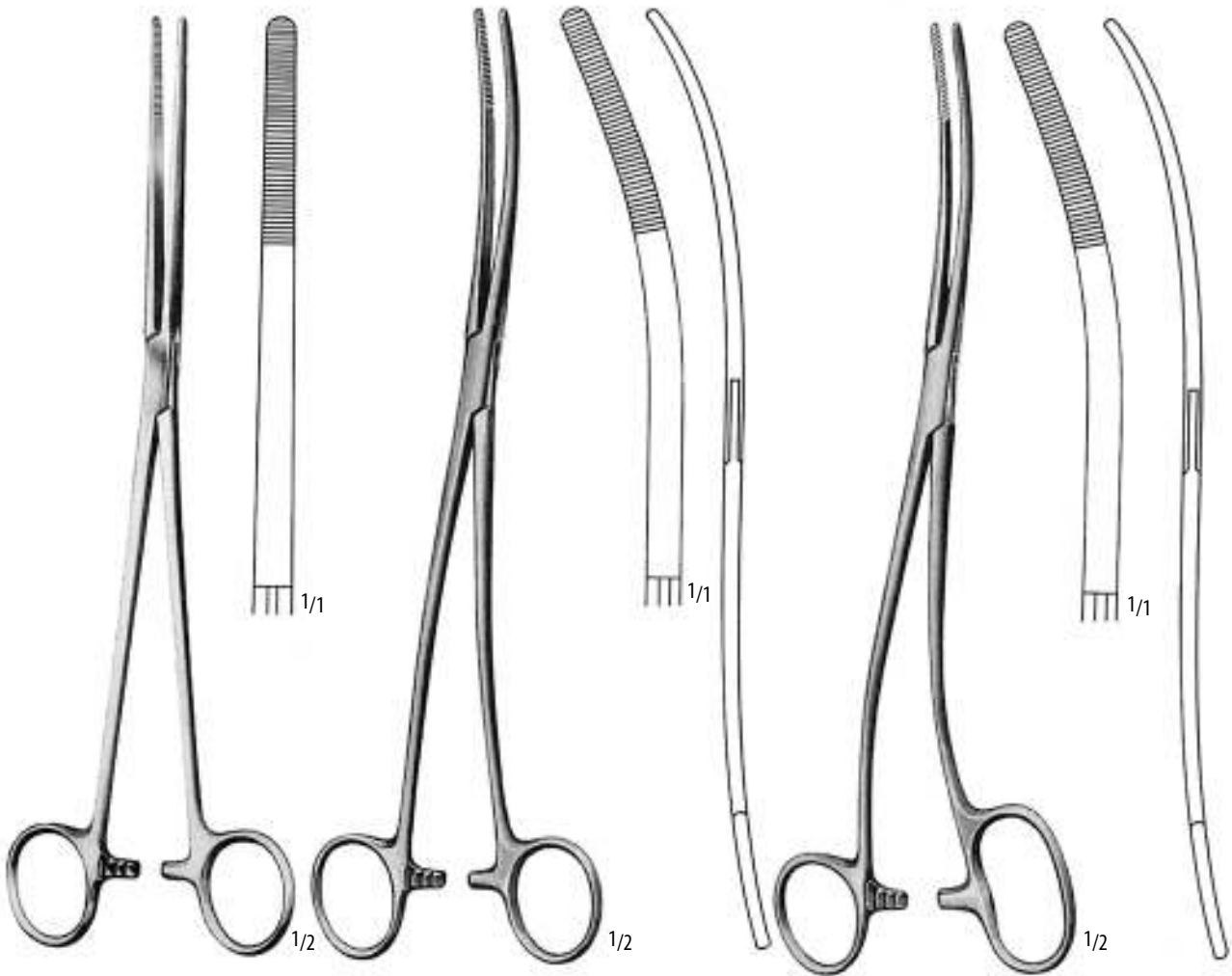

BOZEMANN
CM - 210 - 26
26,0 cm/10¹/₄"

BOZEMANN
CM - 211 - 26
26,0 cm/10¹/₄"

BOZEMANN - DOUGLES
CM - 212 - 26
26,0 cm/10¹/₄"



CHERON
CM - 213 - 25
25,0 cm/10"



COLLIN
CM - 214 - 24
24,0 cm/9 1/2"



NOTO
CM - 215 - 28
27,5 cm/10 3/4"



PELKMANN
CM - 216 - 25
25,0 cm/10"



PELKMANN
CM - 217 - 25
25,0 cm/10"



KELLY
CM - 218 - 32
32,0 cm/12 3/4"

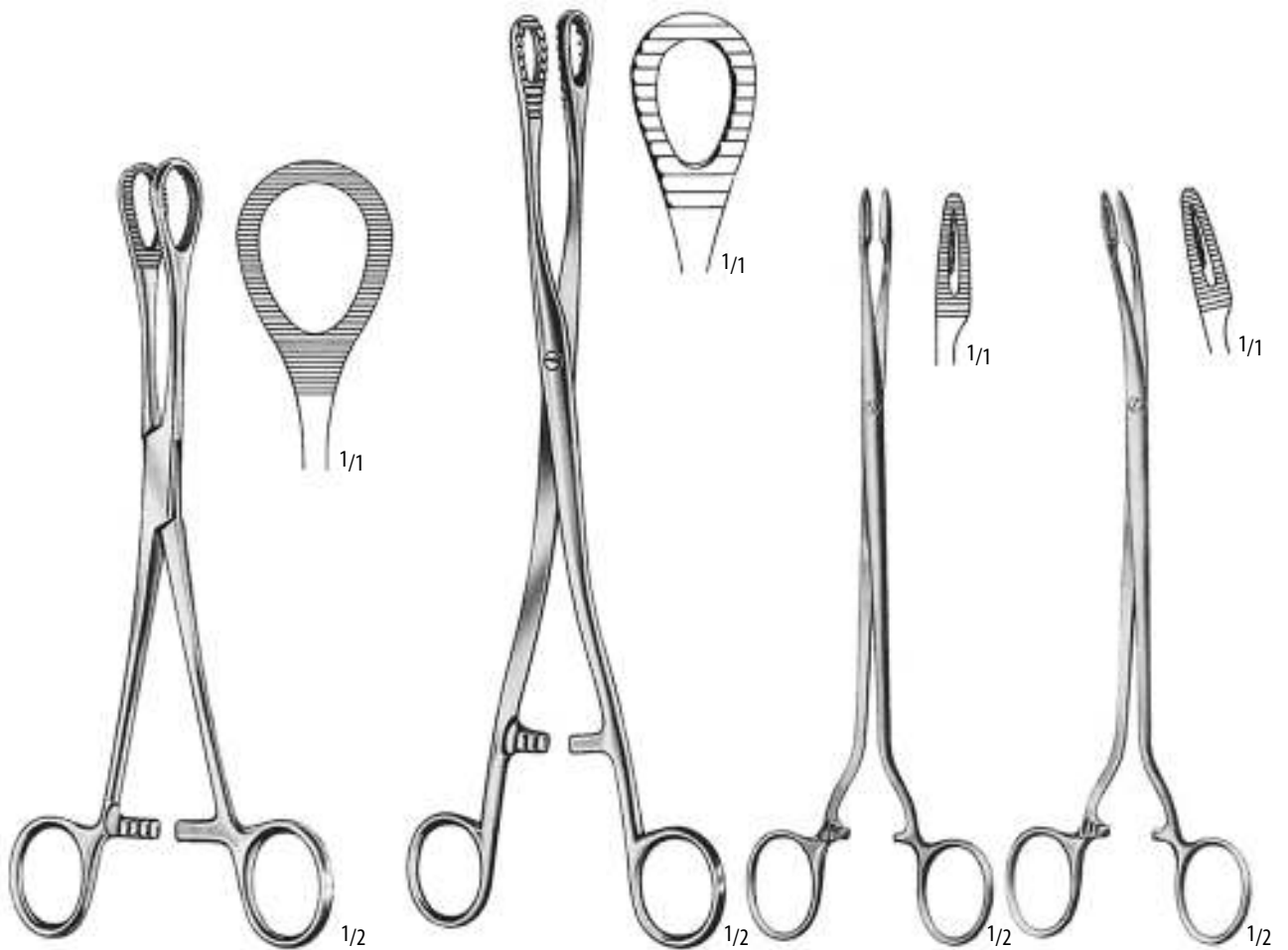

HEYWOOD - SMITH

CM - 219 - 21
21,0 cm/8 1/4"

HEYWOOD - SMITH

CM - 220 - 25
25,0 cm/10"

DUPLAY

CM - 221 - 20
20,5 cm/8 1/4"

DUPLAY

CM - 222 - 20
20,5 cm/8 1/4"



1/1

CM - 223 - 18
CM - 223 - 20



1/1

CM - 224 - 18 18,0 cm/7"
CM - 224 - 20 20,0 cm/8"



1/1

CM - 225 - 18
CM - 225 - 20



1/1

CM - 226 - 18
CM - 226 - 20

FOERSTER - BALLENGER



1/1

CM - 223 - 25



1/1

CM - 224 - 25



1/1

CM - 225 - 25



1/1

CM - 226 - 25



25,0 cm/10"

1/2

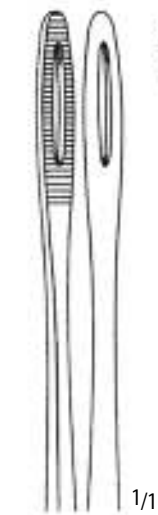

CM - 227 - 25



CM - 228 - 25

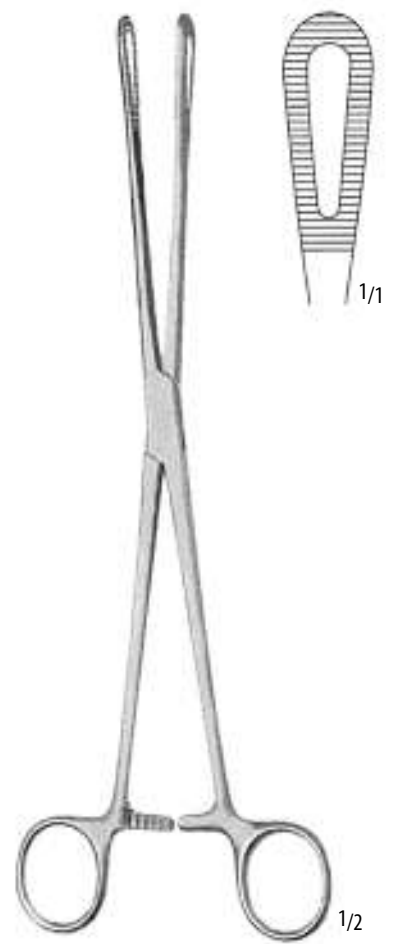

RAMPLEY
CM - 229 - 25
25,0 cm/10"

1/2

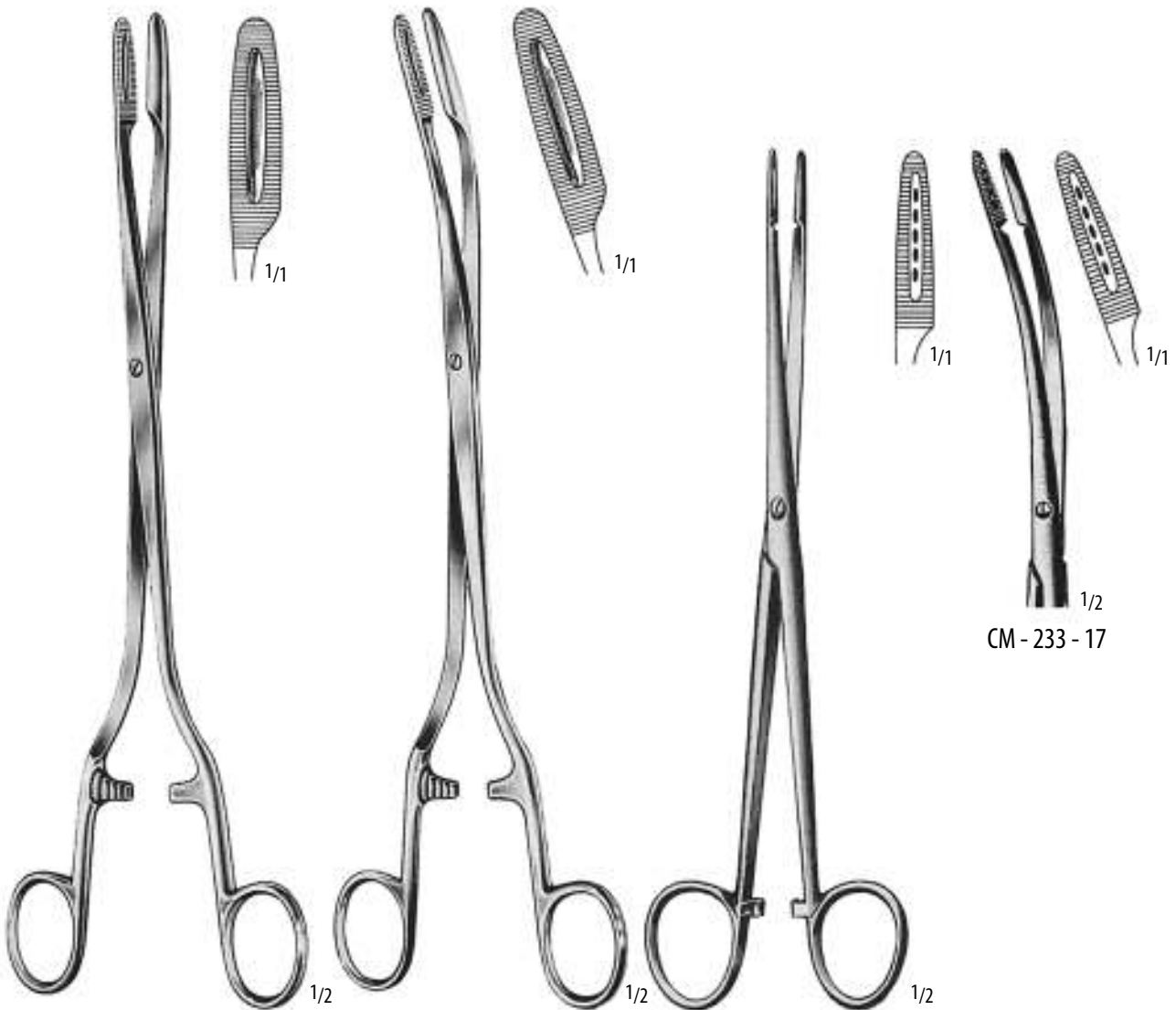

SIMS - MAIER

CM - 230 - 28
28,0 cm/11"

SIMS - MAIER

CM - 231 - 28
28,0 cm/11"

WALTON

17,0 cm/6 ³/₄" CM - 232 - 17
25,5 cm/10" CM - 232 - 25

CM - 233 - 17

HARTMANN

DP - 100 - 01 c 128 DP - 100 - 04 c³ 1024

DP - 100 - 02 c¹ 256 DP - 100 - 05 c⁴ 2048

DP - 100 - 03 c² 512 DP - 100 - 06 c⁵ 4096

Tuning Forks



DP - 100 - 44

Tuning Forks



LUCAE

DP - 100 - 12 c 128

DP - 100 - 14 c¹ 256

DP - 100 - 16 c² 1024

DP - 100 - 18 c³ 2048

Tuning Forks



DP - 101 - 12 c 128

DP - 101 - 25 c¹ 256

Tuning Forks



DP - 102 - 12 c 128

Tuning Forks (for neurologist)



RYDEL - SEIFFER

DP - 103 - 12 c 64 or/order c 128

Tuning fork with clamp c 64,

without clamp c 128



DP - 104 - 12 c 128

Tuning fork, aluminium - alloy



BILLEAU

DP - 105 - 16
 DP - 106 - 16
 Ear loop, straight
 160 mm, 6 1/4"

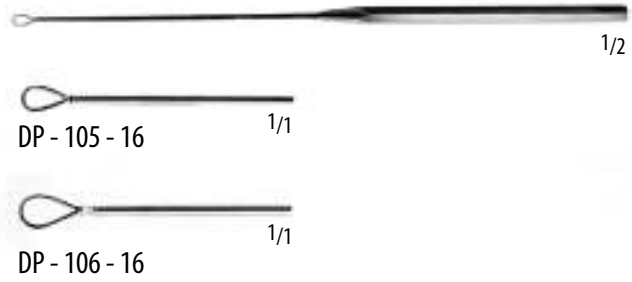

SNELLEN

DP - 107 - 16
 Ear loop, curved, serrated
 160 mm, 6 1/4"

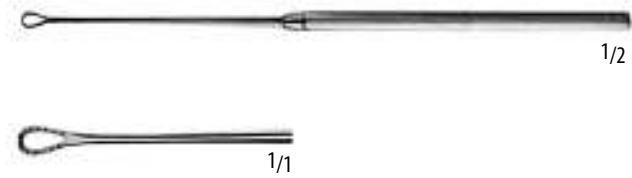

LANGENBECK

DP - 107 - 13
 Ear loop, blunt, slightly curved
 130 mm, 5"



ZAUFAL

DP - 108 - 16
 Ear elevator, blunt
 160 mm, 6 1/4"



MUSGROVE

DP - 109 - 18
 Cerumen pick and wool carrier
 180 mm, 7"



LUCAE

DP - 110 - 14
 DP - 111 - 14
 DP - 112 - 14
 Ear hooks, probe ended
 140 mm, 5 1/2"

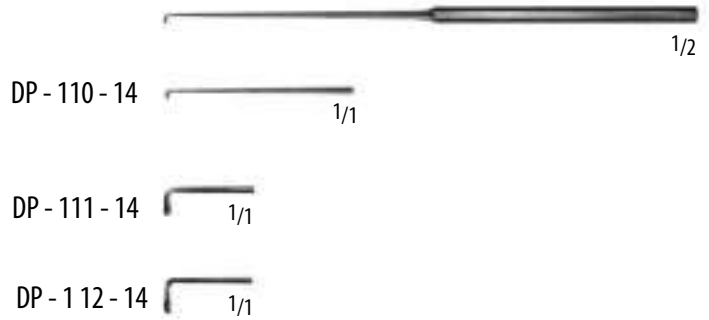

ZAUFEL - JANSEN

DP - 113 - 15
 Ear hooks, probe ended
 150 mm, 6"



WAGENER

DP - 114 - 15
 DP - 115 - 15
 DP - 116 - 15
 DP - 117 - 15
 Ear hooks, probe ended
 150 mm, 6"

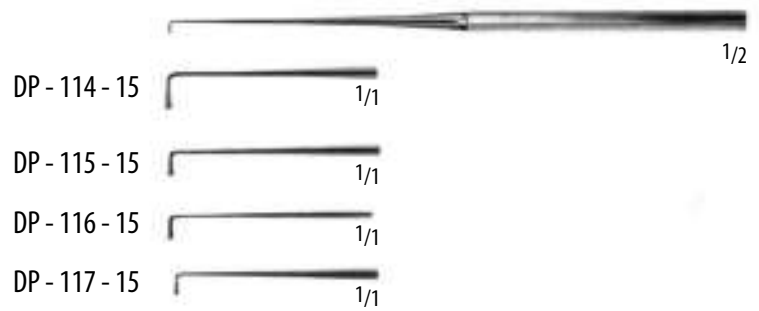

STACKE

DP - 120 - 10
 Ear probe, silver
 100 mm, 4"



CAWTHORNE

DP - 125 - 14
 Cerumen hook
 140 mm, 5"



ST. BARTS

DP - 125 - 18
 Blunt hook
 180 mm, 7"

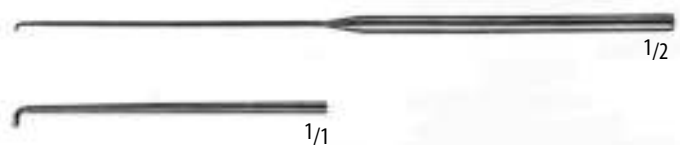

BUCK

		Outside - Ø
DP - 130 - 15	Fig. 00	1,5 mm
DP - 131 - 15	Fig. 00	2,0 mm
DP - 132 - 15	Fig. 00	2,5 mm
DP - 133 - 15	Fig. 00	3,0 mm
DP - 134 - 15	Fig. 00	4,0 mm





Ear currets, curved, sharp
150 mm, 6"



BUCK

		Outside - Ø
DP - 140 - 15	Fig. 00	1,5 mm
DP - 141 - 15	Fig. 00	2,0 mm
DP - 142 - 15	Fig. 00	2,5 mm
DP - 143 - 15	Fig. 00	3,0 mm
DP - 144 - 15	Fig. 00	4,0 mm

Ear currets, curved, blunt
150 mm, 6"

Ø 1,5 mm	Ø 2,0 mm	Ø 2,5 mm	Ø 3,0 mm	Ø 4,0 mm
				
DP - 130 - 15	DP - 131 - 15	DP - 132 - 15	DP - 133 - 15	DP - 134 - 15
DP - 140 - 15	DP - 141 - 15	DP - 142 - 15	DP - 143 - 15	DP - 144 - 15

QUIRE

DP - 150 - 90
Ear forceps for removal of foreign bodies
90 mm, 3 1/2"



BUCK

DP - 151 - 90
Ear forceps alligator type serrated jaws for removal of foreign bodies
90 mm, 3 1/2"



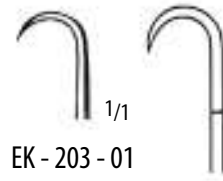
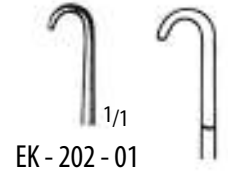
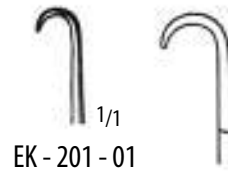

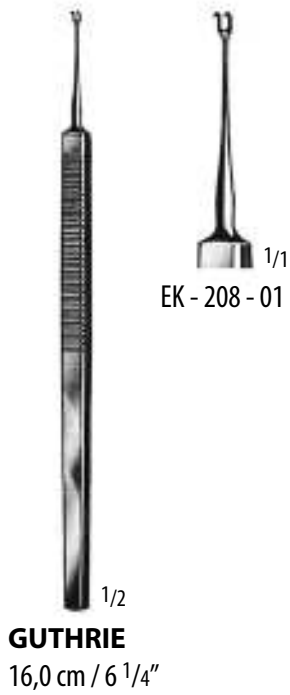
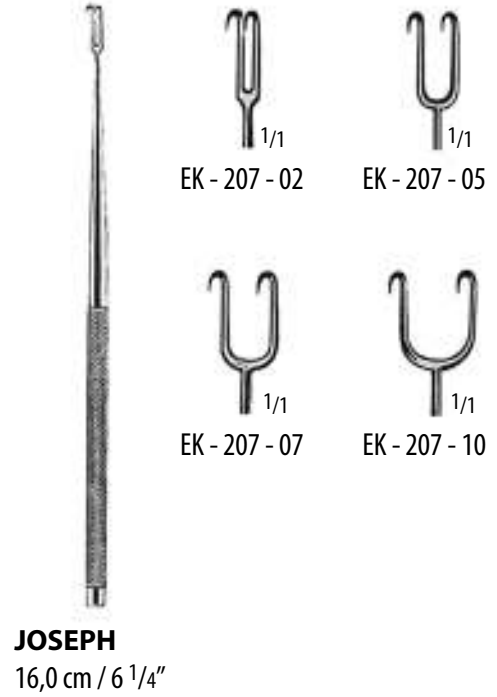
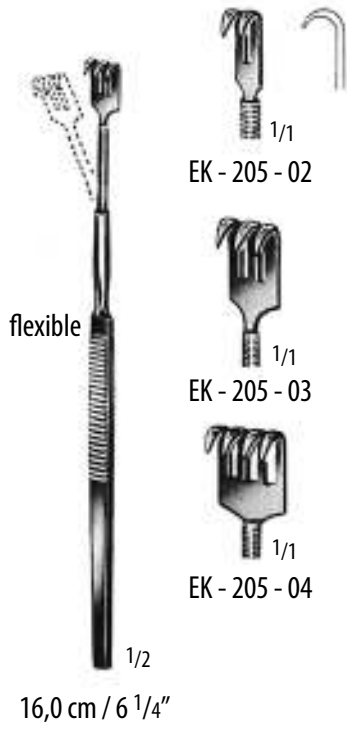



MEYERDING
18,0 cm / 7"



1/1
EK - 212 - 01
18 x 7 mm



1/1
EK - 213 - 02
16 x 5 mm



1/1
EK - 212 - 03
7 x 4 mm



1/1
EK - 213 - 04
10 x 3 mm



1/1
EK - 212 - 05
7 x 4 mm



1/1
EK - 213 - 06
4 x 10 mm



1/2



1/1
EK - 214 - 10
10 x 6 mm



1/1
EK - 214 - 20
20 x 6 mm



MINI - LANGENBECK
16,0 cm / 6 1/4"



1/1
EK - 215 - 10
10 x 6 mm



1/1
EK - 215 - 17
17 x 5 mm



1/1
EK - 215 - 20
20 x 6 mm



1/1
EK - 215 - 22
22 x 8 mm

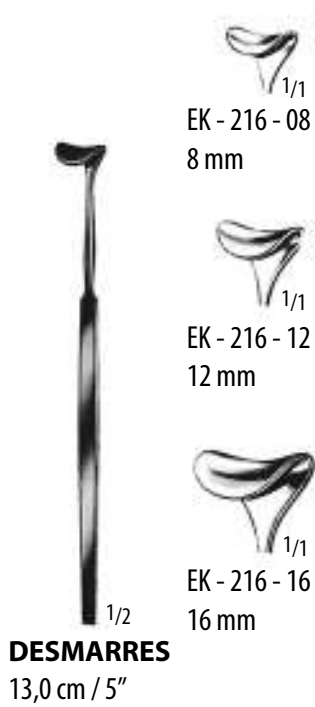

 1/1
EK - 216 - 08
8 mm

 1/1
EK - 216 - 12
12 mm

 1/1
EK - 216 - 16
16 mm



 1/1
EK - 216 - 10
10 mm

 1/1
EK - 216 - 14
14 mm

 1/1
EK - 216 - 18
18 mm

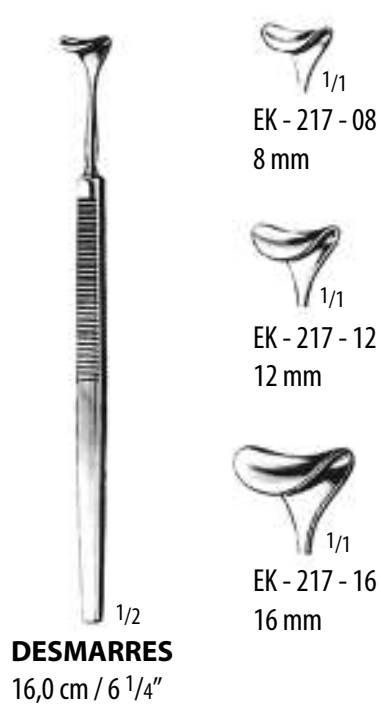

 1/1
EK - 217 - 08
8 mm

 1/1
EK - 217 - 12
12 mm

 1/1
EK - 217 - 16
16 mm



 1/1
EK - 217 - 10
10 mm

 1/1
EK - 217 - 14
14 mm

 1/1
EK - 217 - 18
18 mm

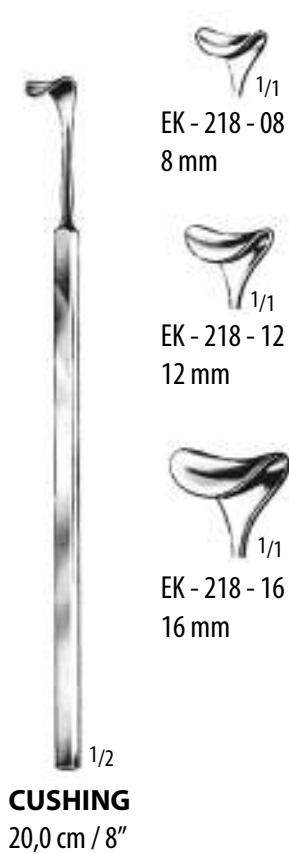

 1/1
EK - 218 - 08
8 mm

 1/1
EK - 218 - 12
12 mm

 1/1
EK - 218 - 16
16 mm



 1/1
EK - 218 - 10
10 mm

 1/1
EK - 218 - 14
14 mm

 1/1
EK - 218 - 18
18 mm

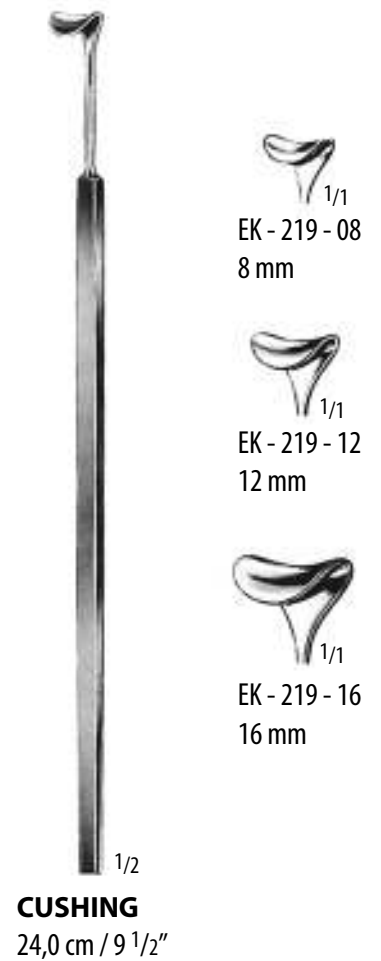

 1/1
EK - 219 - 08
8 mm

 1/1
EK - 219 - 12
12 mm

 1/1
EK - 219 - 16
16 mm



 1/1
EK - 219 - 10
10 mm

 1/1
EK - 219 - 14
14 mm

 1/1
EK - 219 - 18
18 mm

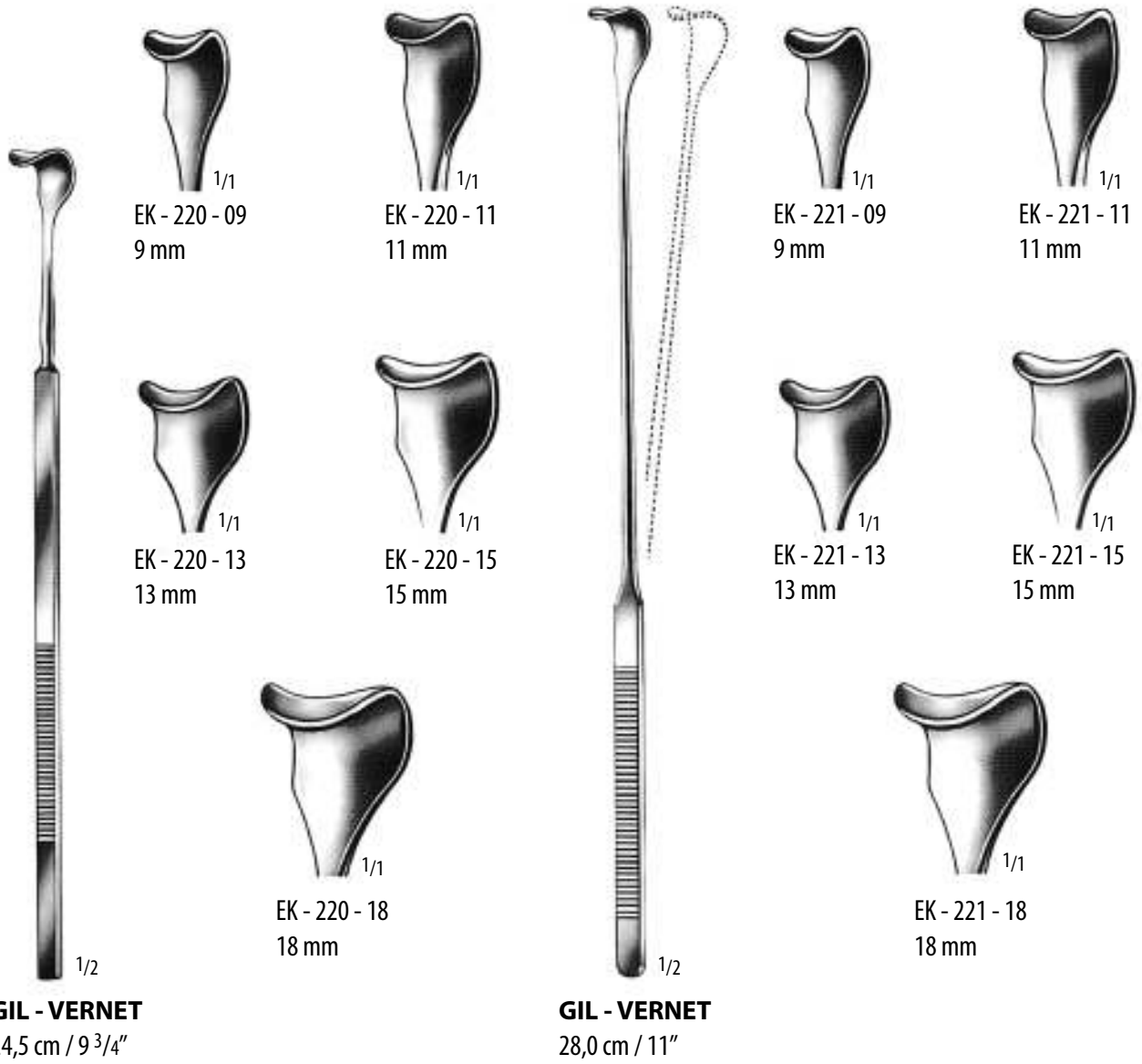

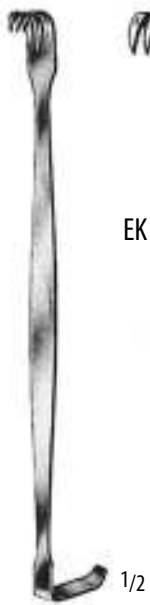

EK - 222 - 15
1/1

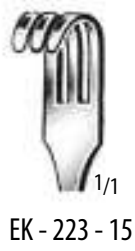

EK - 223 - 15
1/1



EK - 224 - 16
1/1

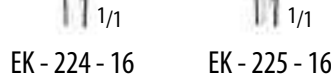

EK - 225 - 16
1/1



RAGNELL - DAVIS
EK - 226 - 14
14,0 cm / 5 1/2"

BABY - SENN - MILLER
15,0 cm / 6"

SENN - MILLER
16,0 cm / 6 1/4"



CUSHING
EK - 227 - 20
20,0 cm / 8"



TAYLOR
16,5 cm / 6 1/2"

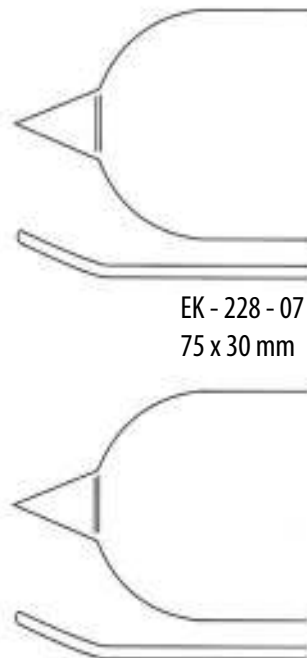

EK - 228 - 07
75 x 30 mm

EK - 228 - 10
100 x 30 mm



VOLKLANN
21,5 cm / 8 1/2"

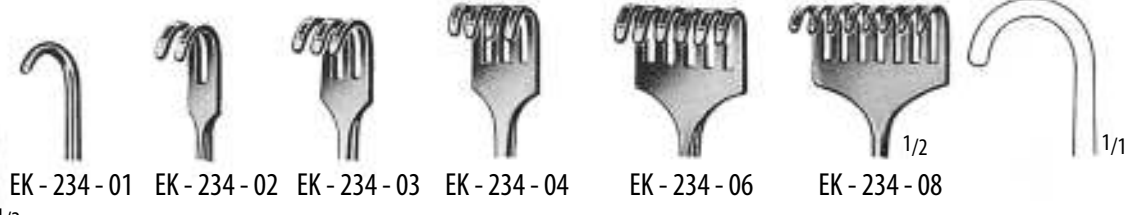
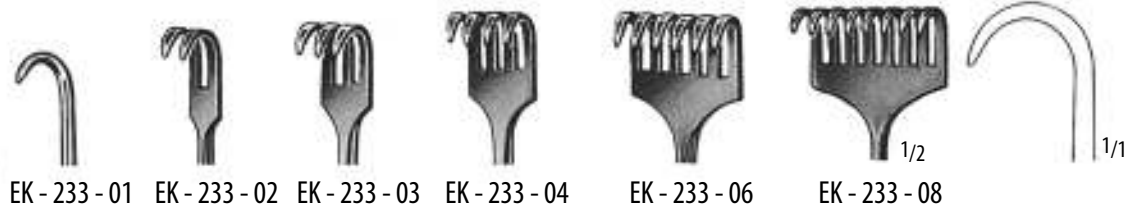
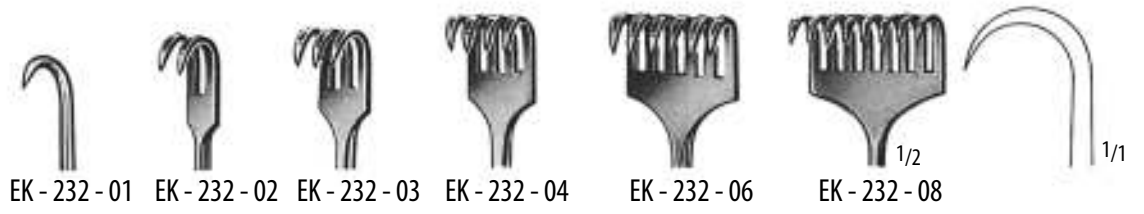

KOCHER
22,0 cm / 8 3/4"



1/2

VOLKMANN
21,5 cm / 8 1/2"



1/1
EK - 235 - 21



1/1
EK - 236 - 21



1/2

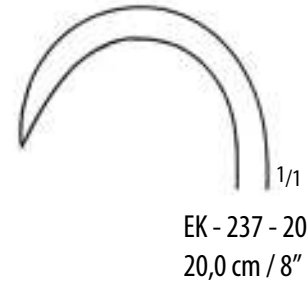

1/1
EK - 237 - 20
20,0 cm / 8"

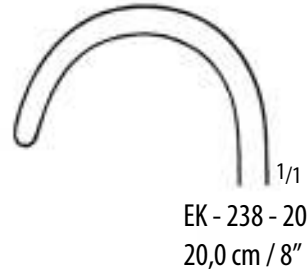

1/1
EK - 238 - 20
20,0 cm / 8"



1/2

KOERTE
24,0 cm / 9 1/2"

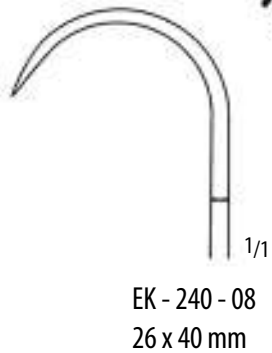

1/1
EK - 240 - 08
26 x 40 mm



1/1
EK - 241 - 08
26 x 40 mm



1/2

BILLROTH
25,0 cm / 10"



1/1
EK - 242 - 35
35 x 40 mm



1/2
EK - 242 - 43
45 x 35 mm



1/2
EK - 242 - 45
45 x 50 mm



OLLIER
22,5 cm / 9"



ISRAEL
25,0 cm / 10"





LANGENBECK
1/2 21,0 cm / 8 1/4"

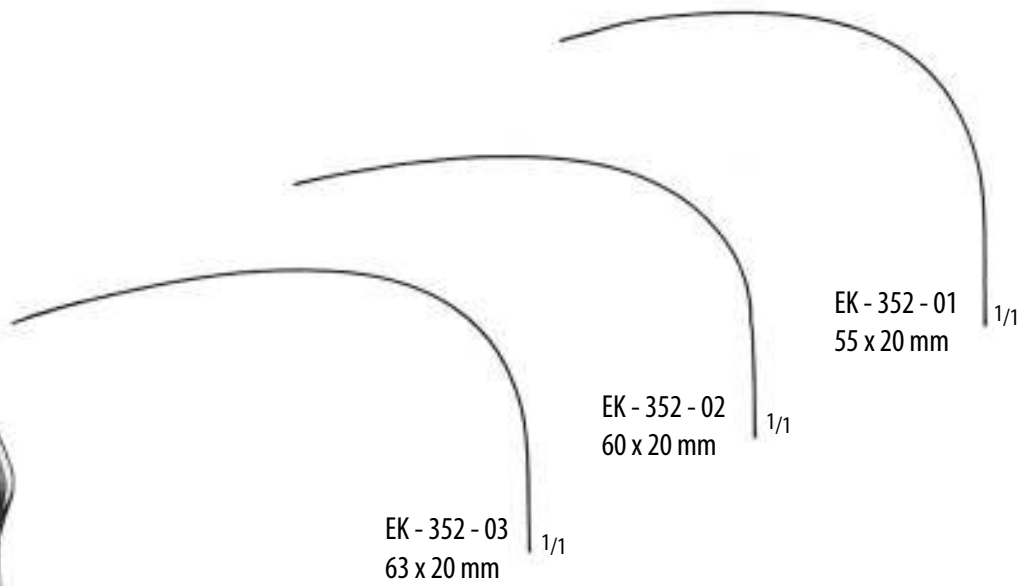

EK - 352 - 01
55 x 20 mm

EK - 352 - 02
60 x 20 mm

EK - 352 - 03
63 x 20 mm



LANGENBECK
EK - 353 - 01 - 05
22,0 cm / 8 1/2"



EK - 353 - 01
EK - 354 - 01
30 x 11 mm



EK - 353 - 02
EK - 354 - 02
30 x 14 mm



EK - 353 - 03
EK - 354 - 03
30 x 16 mm



EK - 353 - 04
EK - 354 - 04
40 x 11 mm



EK - 353 - 05
50 x 11 mm



LANGENBECK
EK - 353 - 01
22,0 cm / 8 1/2"



KOCHER - LANGENBECK
21,5 cm / 8 1/2"

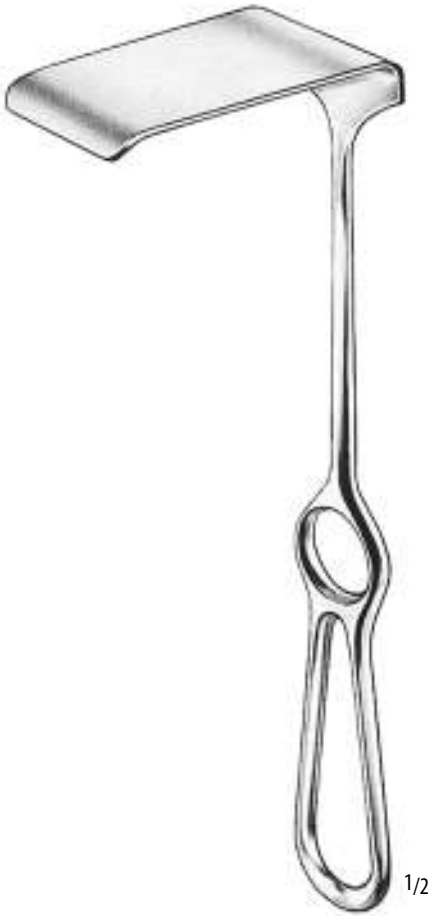

KOCHER
23,0 cm / 9"

1/2

EK - 356 - 18
40 x 18 mm

1/1

EK - 356 - 20
60 x 20 mm

1/1

EK - 356 - 25
60 x 25 mm

1/1

EK - 356 - 30
75 x 30 mm

1/1

EK - 356 - 40
75 x 40 mm

1/1

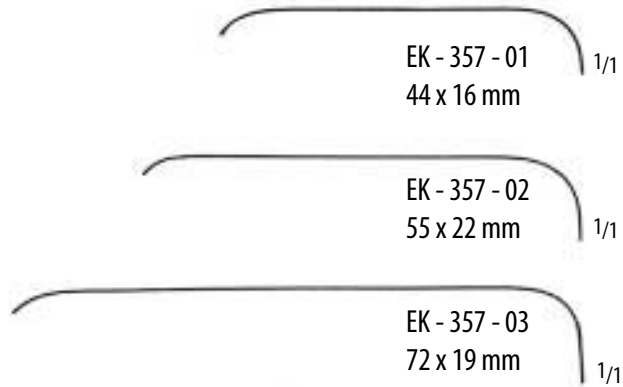

EK - 357 - 01
44 x 16 mm

1/1

EK - 357 - 02
55 x 22 mm

1/1

EK - 357 - 03
72 x 19 mm

1/1

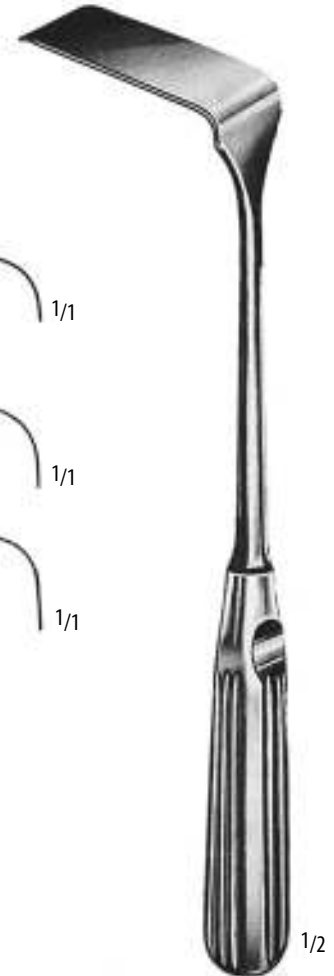

1/2

SAUERBRUCH
22,5 cm / 8 3/4"

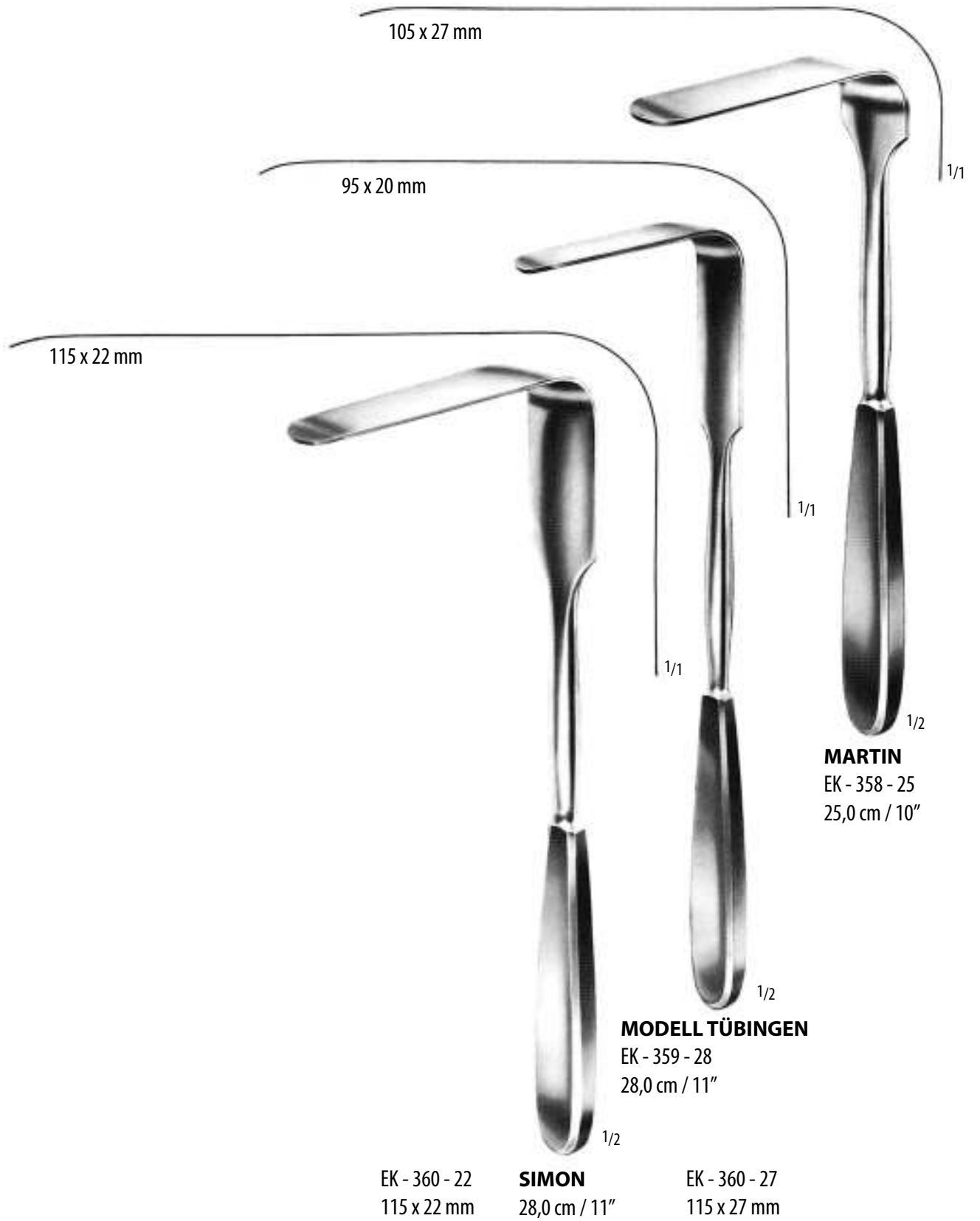

BRUNNER

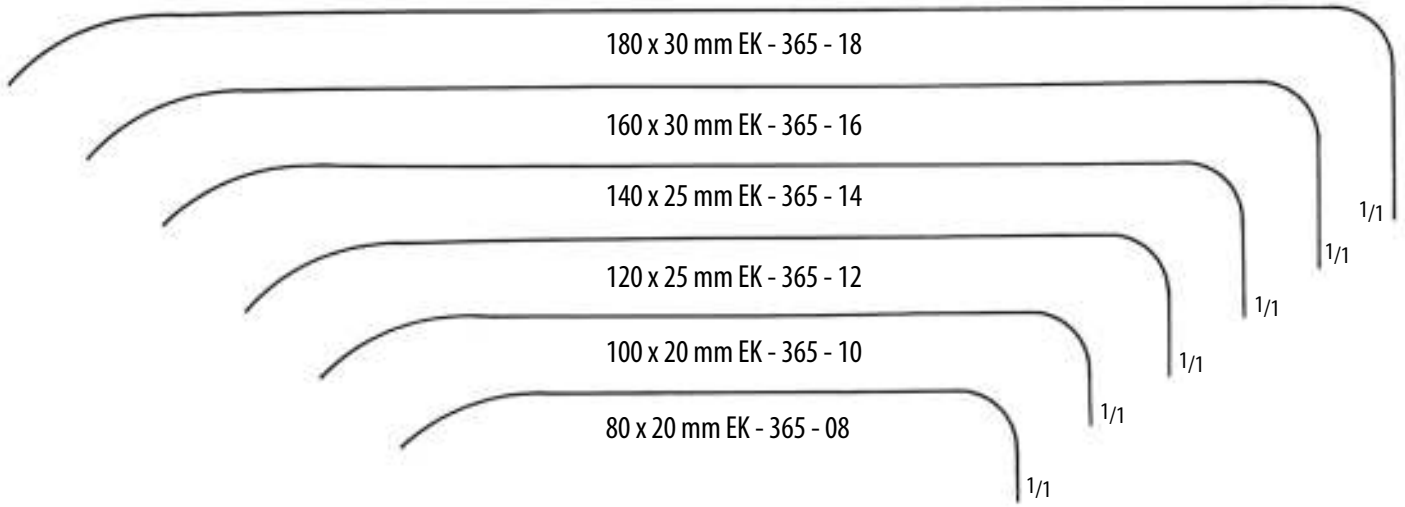

BRUNNER
EK - 366 - 18
25,0 cm / 10"



LAHEY
EK - 367 - 19
19,0 cm / 7 1/2"



LITTLE
EK - 368 - 20
20,0 cm / 8"



1/2 **MIDDELDORPF**



14 x 17 mm
EK - 369 - 17
EK - 370 - 17
21,5 cm / 8 1/2"



20 x 22 mm
EK - 369 - 22
EK - 370 - 22
22,0 cm / 8 3/4"



MIDDELDORPF

1/2

49 x 38 mm
28 x 20 mm

Fig. 1

Fig. 2

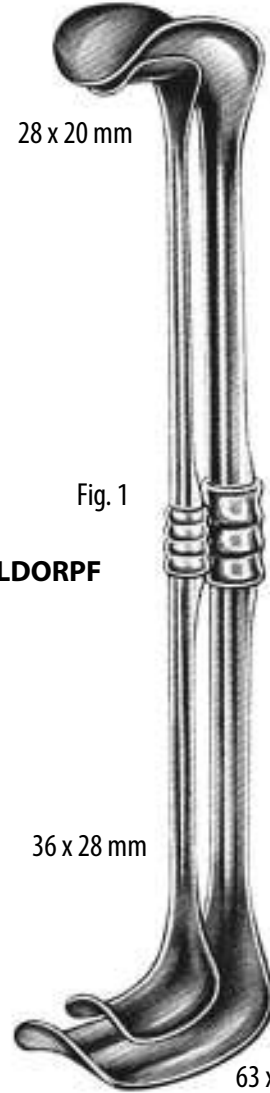

36 x 28 mm

63 x 49 mm

RICHARDSON - EASTMAN

Fig. 1+2

EK - 372 - 00

Fig. 1 21,5 cm / 8 1/2"

EK - 372 - 01

Fig. 21,5 cm / 8 1/2"

EK - 372 - 02



EK - 371 - 01
28 x 20 mm



EK - 371 - 02
36 x 28 mm



EK - 371 - 03
44 x 38 mm



EK - 371 - 04
52 x 22 mm



EK - 371 - 05
65 x 50 mm



RICHARDSON (KELLY)

1/2 24,0 cm / 9 1/2"



HOESEL
25,0 cm / 10"

1/2



EK - 373 - 01
60 x 20 mm

1/1



EK - 373 - 02
80 x 30 mm

1/1



EK - 373 - 03
100 x 30 mm

1/1



EK - 373 - 04
120 x 30 mm

1/1



EK - 373 - 05
140 x 30 mm

1/1



EK - 373 - 06
140 x 40 mm

1/1



1/2

FRITSCH
24,0 cm / 9 1/2"

45 x 40 mm	EK - 374 - 40
45 x 50 mm	EK - 374 - 50
45 x 60 mm	EK - 374 - 60
45 x 75 mm	EK - 374 - 75
65 x 85 mm	EK - 374 - 85

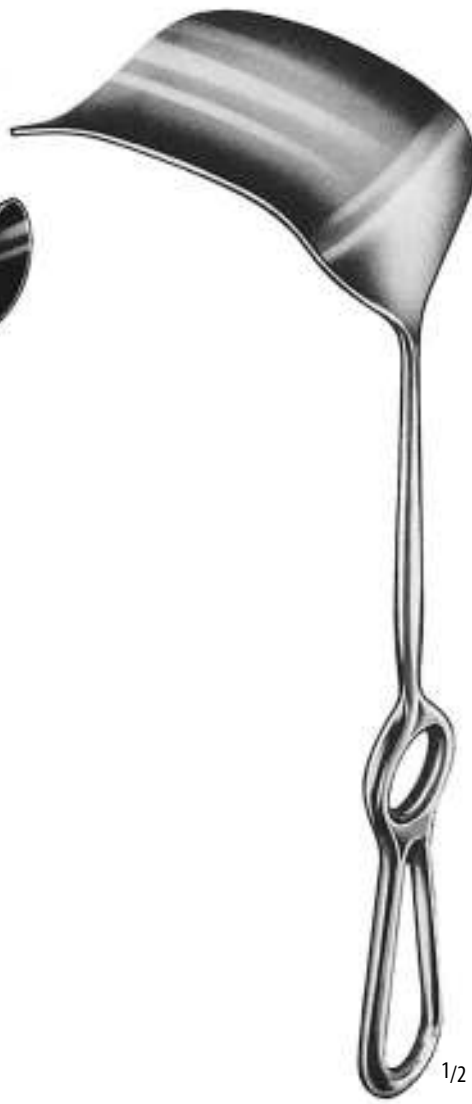

1/2

KOCHER

70 x 25 mm	22,0 cm / 9"	EK - 375 - 25
80 x 42 mm	25,0 cm / 10"	EK - 375 - 42
80 x 50 mm	25,0 cm / 10"	EK - 375 - 50
80 x 60 mm	25,0 cm / 10"	EK - 375 - 60



1/2

DOYEN - STILLE
24,0 cm / 9 1/2"

90 x 15 mm	EK - 376 - 15
90 x 20 mm	EK - 376 - 20
90 x 30 mm	EK - 376 - 30
110 x 35 mm	EK - 376 - 35
110 x 40 mm	EK - 376 - 40
120 x 55 mm	EK - 376 - 55

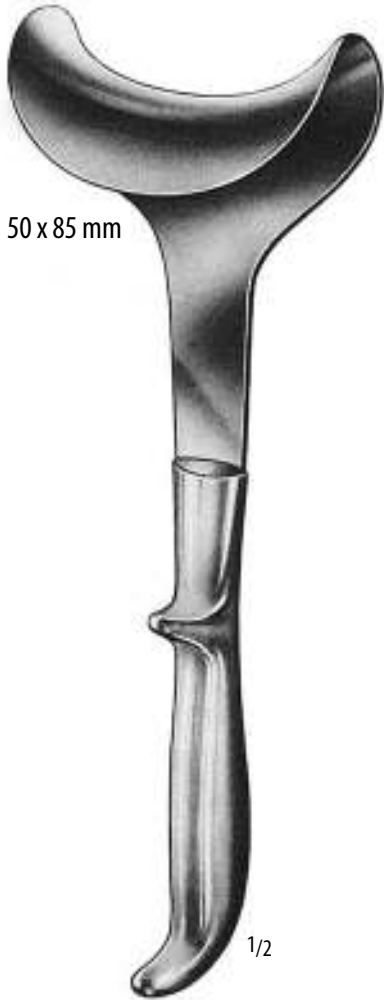
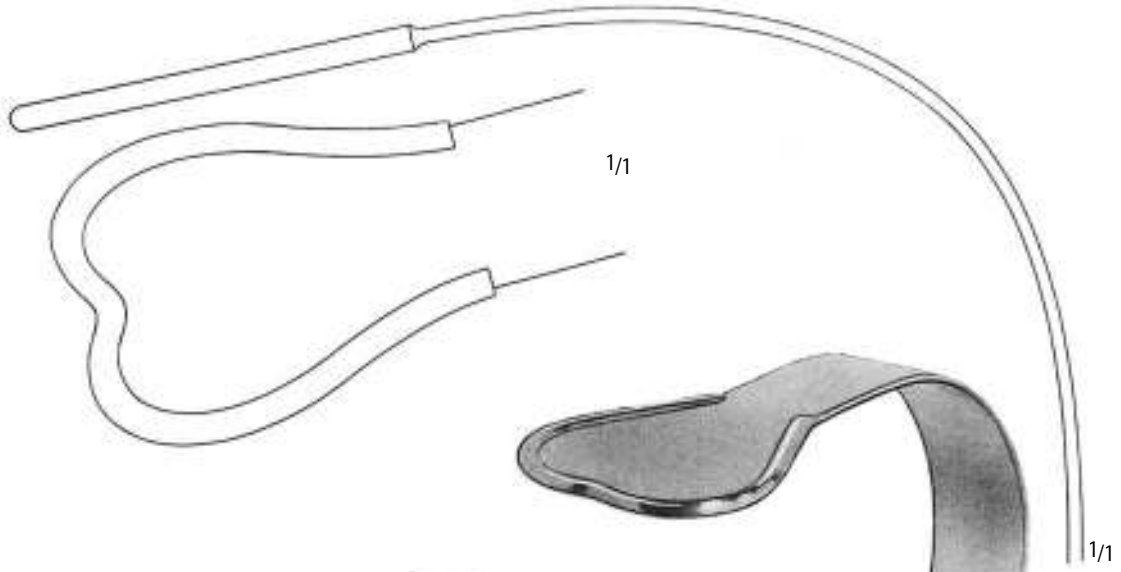

50 x 85 mm

1/2

DOYEN
EK - 377 - 25
25,0 cm / 10"



64 x 60 mm

1/2

TUFFIER
EK - 378 - 23
23,0 cm / 9"



1/2

HARRINGTON
32,0 cm / 12 1/2"

- 127 x 40 mm EK - 379 - 40
- 127 x 62 mm EK - 379 - 62
- 175 x 64 mm EK - 379 - 64

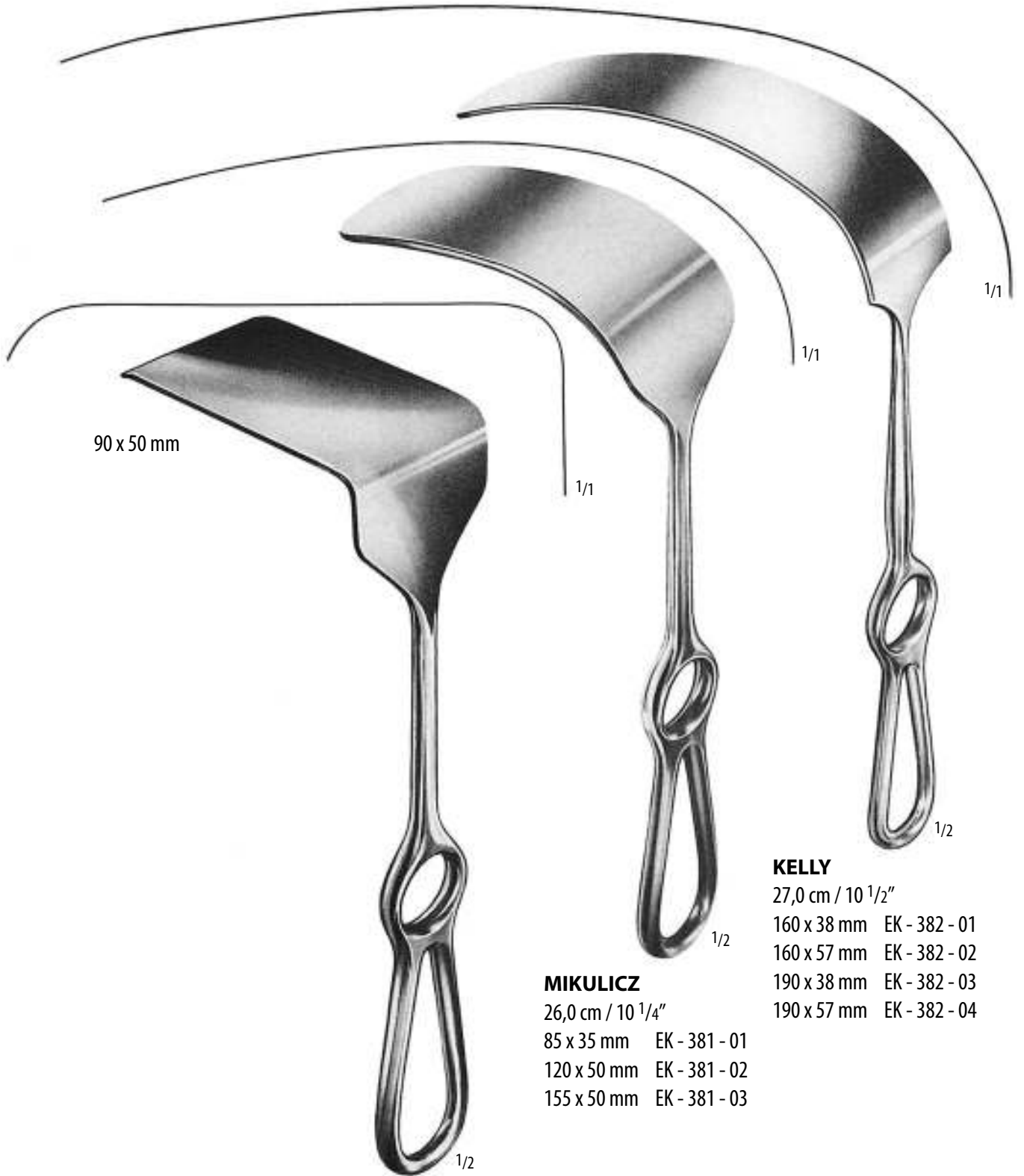

90 x 50 mm

1/1

1/1

1/1

1/2

1/2

1/2

MIKULICZ

EK - 380 - 26

26,0 cm / 10 1/4"

MIKULICZ

26,0 cm / 10 1/4"

85 x 35 mm EK - 381 - 01

120 x 50 mm EK - 381 - 02

155 x 50 mm EK - 381 - 03

KELLY

27,0 cm / 10 1/2"

160 x 38 mm EK - 382 - 01

160 x 57 mm EK - 382 - 02

190 x 38 mm EK - 382 - 03

190 x 57 mm EK - 382 - 04





DEAVER
EK - 384 - 07
30,0 cm / 12"



DEAVER
EK - 384 - 08
30,0 cm / 12"



DEAVER
EK - 384 - 09
30,0 cm / 12"

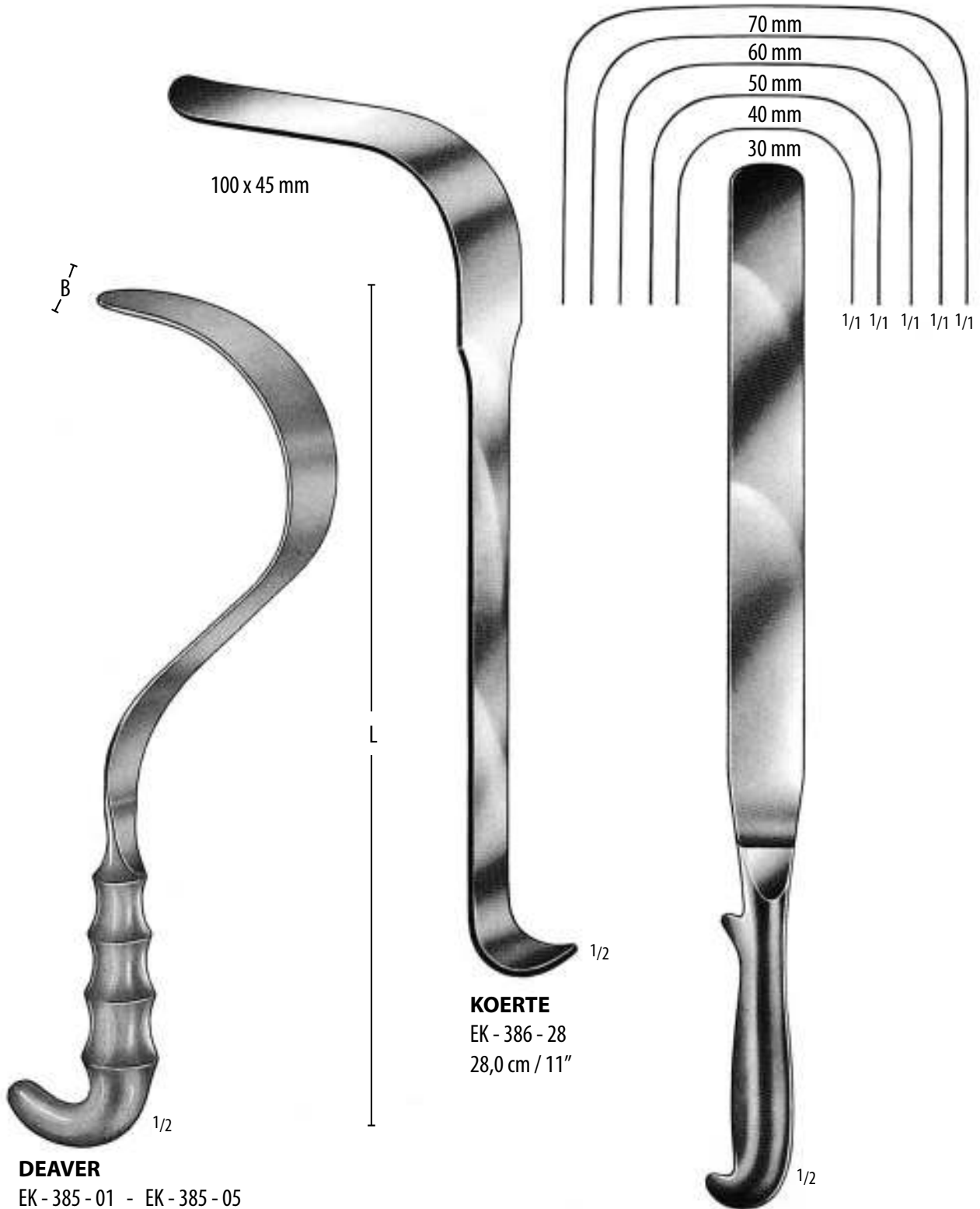

DEAVER
EK - 385 - 01 - EK - 385 - 05

KOERTE
EK - 386 - 28
28,0 cm / 11"

41,0 cm / 16"

	B	L	
Fig. 1	25 mm	30,5 cm / 12"	EK - 385 - 01
Fig. 2	25 mm	33,0 cm / 13"	EK - 385 - 02
Fig. 3	38 mm	30,5 cm / 12"	EK - 385 - 03
Fig. 4	50 mm	30,5 cm / 12"	EK - 385 - 04
Fig. 5	75 mm	30,5 cm / 12"	EK - 385 - 05

245 x 30 mm	EK - 387 - 30
245 x 40 mm	EK - 387 - 40
245 x 50 mm	EK - 387 - 50
245 x 60 mm	EK - 387 - 60
245 x 70 mm	EK - 387 - 70

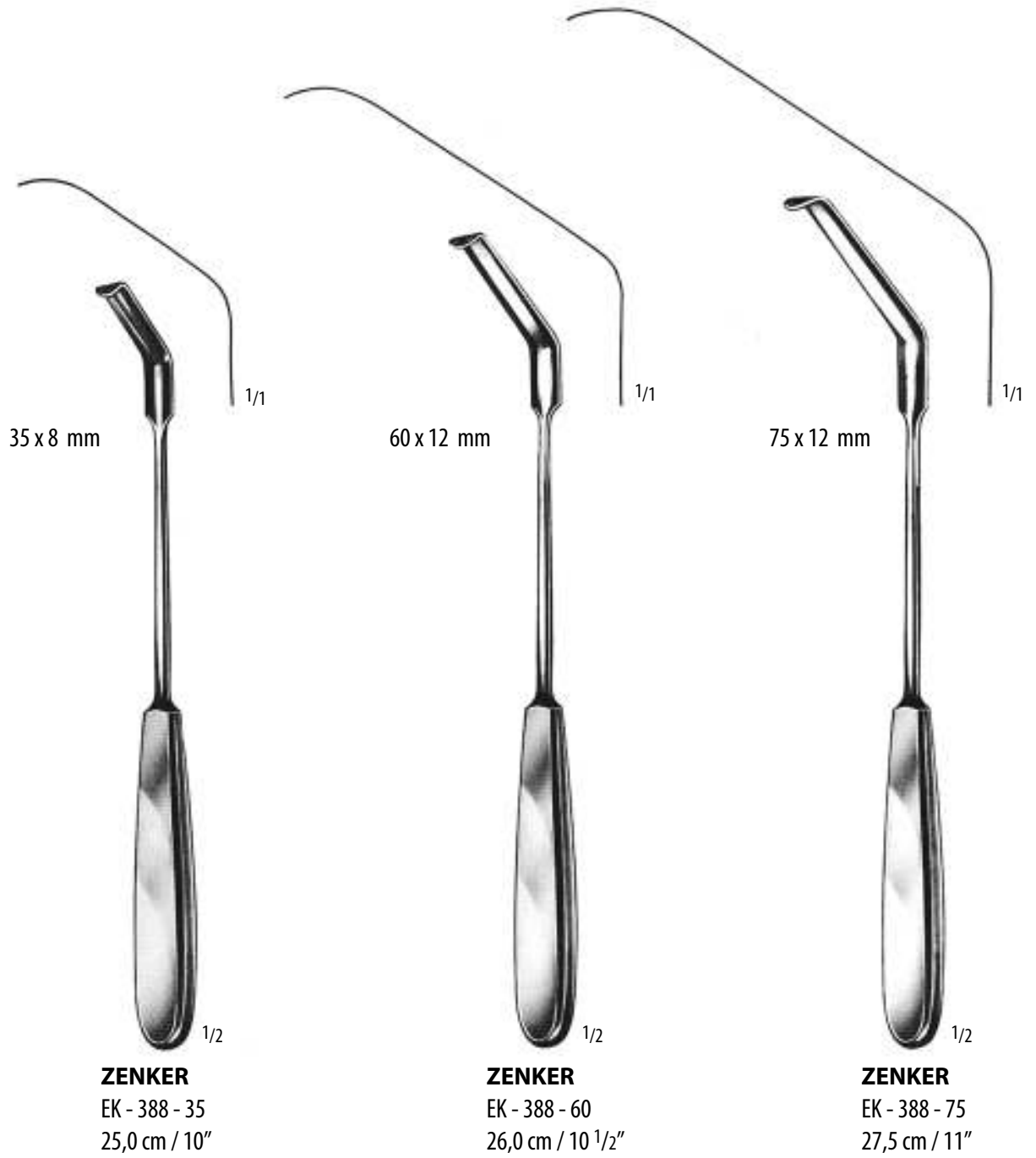

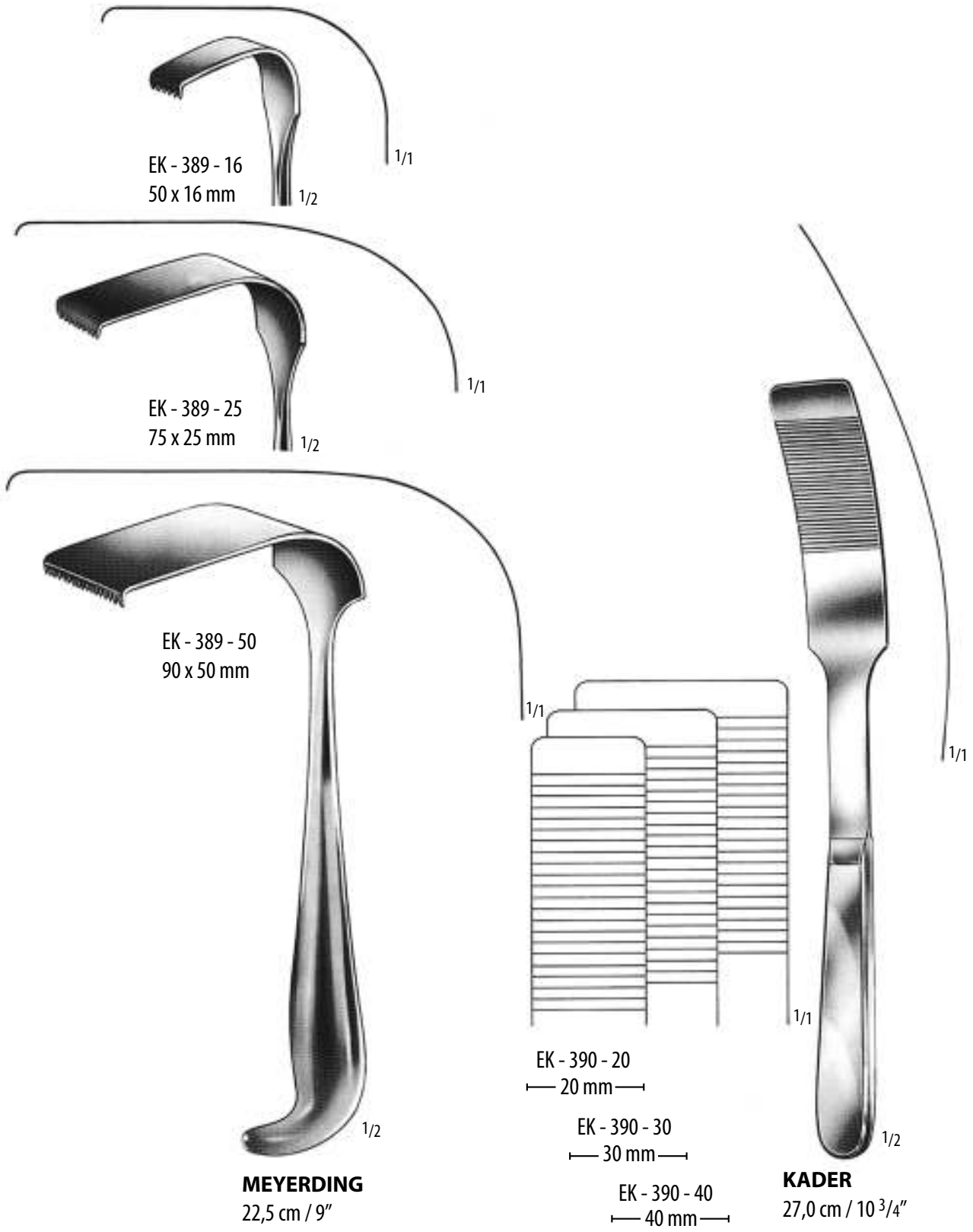



EK - 391 - 22
82 x 22 mm



EK - 391 - 38
115 x 38 mm



EK - 391 - 65
115 x 65 mm

CORYLLOS
24,0 cm / 9 1/2"



130 x 38 mm

SAUERBRUCH
EK - 392 - 25
25,0 cm / 10"

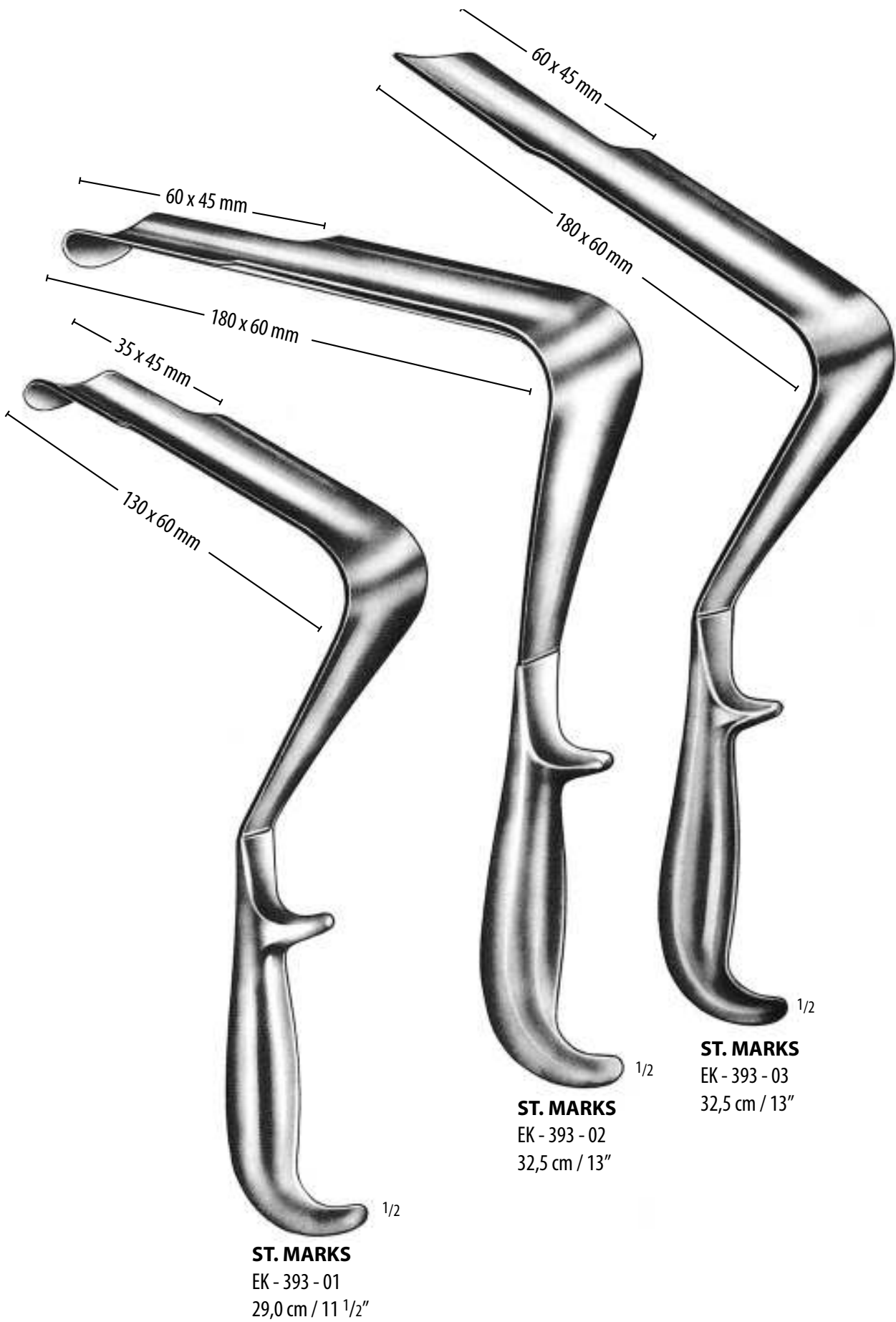



75 x 50 mm

DAVIDSON
EK - 394 - 50
16,0 cm / 6 1/4"



75 x 90 mm

CORYLLOS
EK - 394 - 90
16,0 cm / 6 1/4"

75 x 120 mm

DAVIDSON
EK - 394 - 12
16,0 cm / 6 1/4"

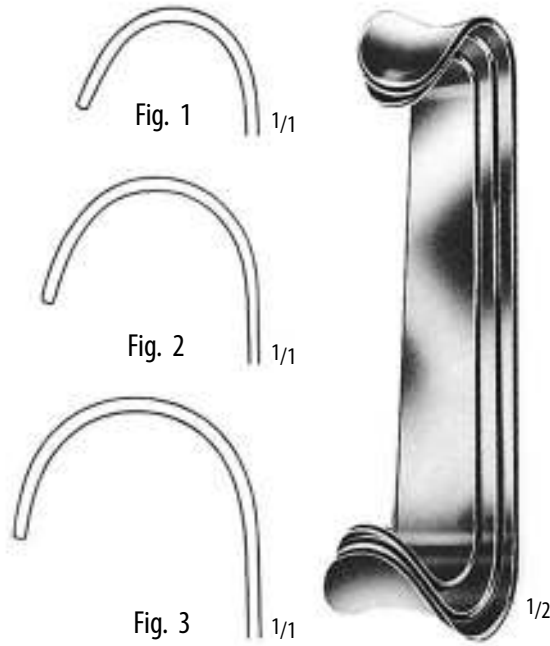

ROUX
16,5 cm / 6 1/2"

- Fig. 1+2+3 EK - 396 - 00
- Fig. 1 EK - 396 - 01
- Fig. 2 EK - 396 - 02
- Fig. 3 EK - 396 - 03

HEANEY
27,0 cm / 10 1/2"

- 45 x 25 mm EK - 395 - 01
- 73 x 28 mm EK - 395 - 02
- 82 x 28 mm EK - 395 - 03

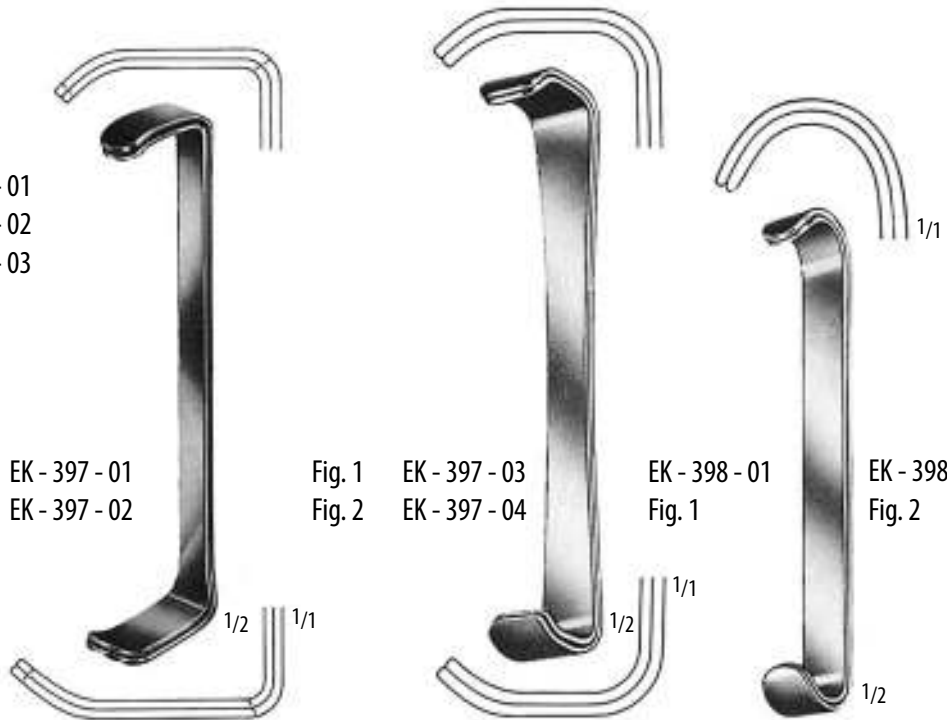

Fig. 1 EK - 397 - 01
Fig. 2 EK - 397 - 02

Fig. 1 EK - 397 - 03
Fig. 2 EK - 397 - 04

EK - 398 - 01
Fig. 1 EK - 398 - 02
Fig. 2

FARABEUF
EK - 397 - 00 Fig. 1 + 2
12,0 cm / 4 3/4"

FARABEUF
EK - 397 - 05 Fig. 1 + 2
15,0 cm / 6"

PARKER
EK - 398 - 00 Fig. 1 + 2
13,5 cm / 5 1/4"



EK - 399 - 01
Fig. 1



EK - 399 - 02
Fig. 2



PARKER
EK - 399 - 00 Fig. 1 + 2
18,0 cm / 7"



EK - 400 - 01
Fig. 1



EK - 400 - 02
Fig. 2



MATHIEU
EK - 400 - 00 Fig. 1 + 2
20,0 cm / 8"



EK - 401 - 01
Fig. 1



EK - 401 - 02
Fig. 2

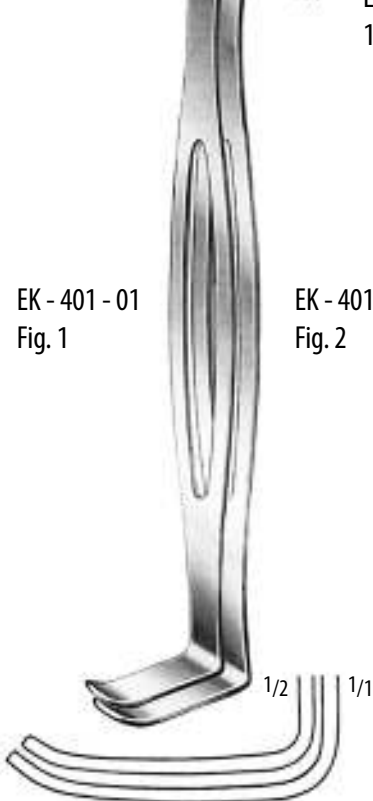

PARKER - LANGENBECK
EK - 401 - 00 Fig. 1 + 2
21,0 cm / 8 1/4"



30 x 31 mm



GOELET
EK - 402 - 19
19,0 cm / 7 1/2"

37 x 40 mm

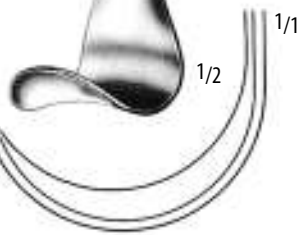



FINSEN

- | | |
|-----------------|--|
| 5,0 cm / 2" | 7,0 cm / 2 ³ / ₄ " |
| △ EK - 420 - 05 | EK - 420 - 07 |
| ∩ EK - 421 - 05 | EK - 421 - 07 |



- | | |
|-----------------|-----------------|
| △ EK - 422 - 10 | ∩ EK - 423 - 10 |
| 10,0 cm / 4" | |



ALM

- | | |
|--|---------------|
| 7,0 cm / 2 ³ / ₄ " | 10,0 cm / 4" |
| △ EK - 424 - 07 | EK - 424 - 10 |
| ∩ EK - 425 - 07 | EK - 425 - 10 |



^ **JANSEN** ^

EK - 426 - 10 EK - 427 - 10
10,0 cm / 4"



^ **JANSEN** ^

EK - 428 - 10 EK - 429 - 10
10,0 cm / 4"



^ **SNITMAN** ^

EK - 430 - 10 EK - 431 - 10
10,5 cm / 4 1/4"



WEITLANER - BABY
EK - 432 - 14
14,0 cm / 5 1/2"



WEITLANER
EK - 433 - 13 EK - 434 - 10
13,0 cm / 5"



WEITLANER

10,5 cm / 4 1/4" 2 X 3
13,0 cm / 5" 3 X 4
16,5 cm / 6 1/2" 3 X 4
20,0 cm / 8" 3 X 4
25,0 cm / 10" 3 X 4
26,0 cm / 10 1/2" 5 X 6

^	^
EK - 435 - 10	EK - 436 - 10
EK - 435 - 13	EK - 436 - 13
EK - 435 - 16	EK - 436 - 16
EK - 435 - 20	EK - 436 - 20
EK - 435 - 25	EK - 436 - 25
EK - 435 - 26	EK - 436 - 26

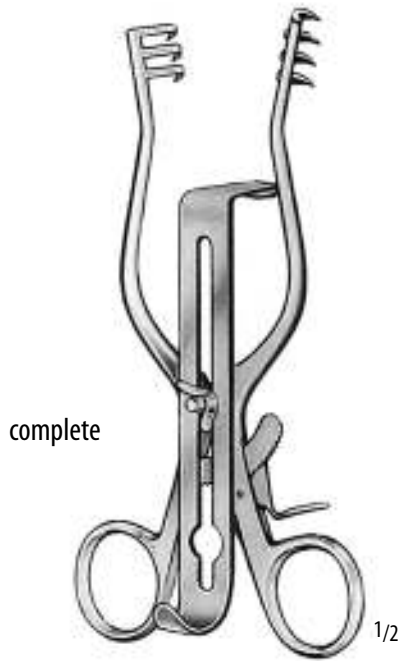

HENLEY

\wedge \cap
 EK - 437 - 00 EK - 438 - 00
 16,5 cm / 6 1/2"

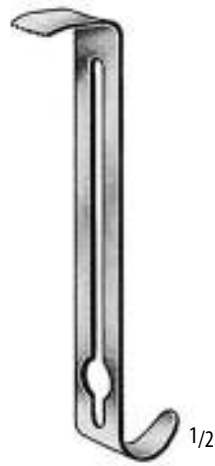

19 mm x 16 mm
EK - 437 - 19

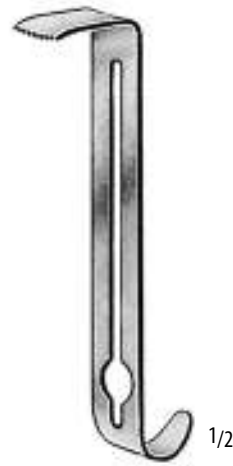

25 mm x 16 mm
EK - 437 - 25



32 mm x 16 mm
EK - 437 - 32



MILLIGAN

\wedge \cap
 EK - 439 - 13 EK - 440 - 13
 13,0 cm / 5"



TRAVERS

EK - 441 - 21
 21,0 cm / 8 1/4"



1/2

SCHUHKNECHT



EK - 442 - 14 EK - 443 - 14

14,0 cm / 5 1/2"



1/2

WULLSTEIN



10,5 cm / 4 1/2" EK - 444 - 10 EK - 445 - 10

13,0 cm / 5" EK - 444 - 13 EK - 445 - 13

16,0 cm / 6 1/4" EK - 444 - 16 EK - 445 - 16



1/2

MOLLISON



EK - 446 - 15 EK - 447 - 18

15,0 cm / 6"

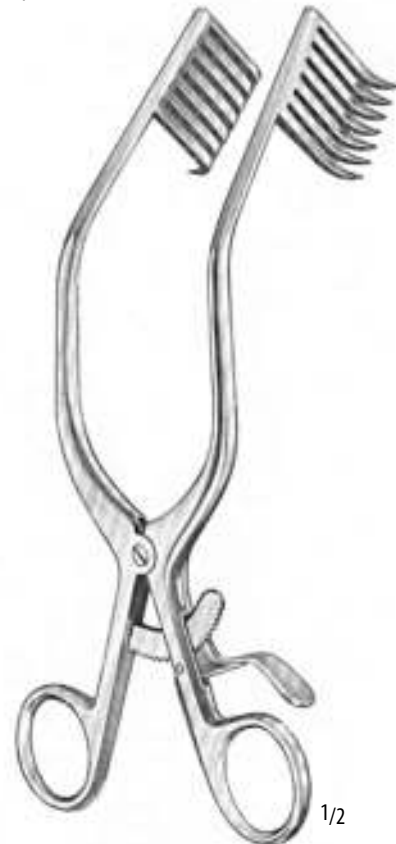

1/2

MOLLISON



EK - 448 - 22 EK - 449 - 22

22,0 cm / 8 1/2"



ADSON
 ^ ∩
 EK - 450 - 20 EK - 451 - 20
 20,0 cm / 8"



ANDERSON - ADSON
 ^ ∩
 EK - 452 - 20 EK - 453 - 27
 20,0 cm / 8"

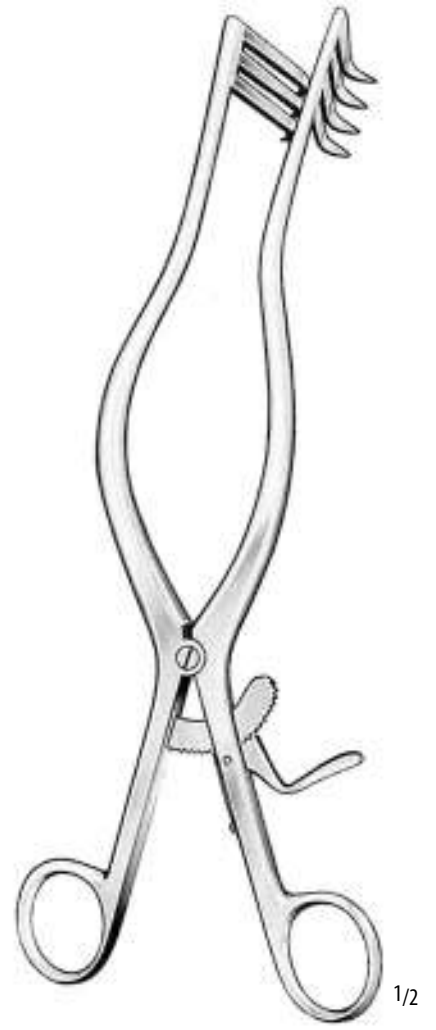

ADSON
 ^ ∩
 EK - 454 - 27 EK - 455 - 27
 27,0 cm / 10 1/2"



ADSON
EK - 456 - 27
27,0 cm / 10 1/2"



ADSON
EK - 457 - 01
27,0 cm / 10 1/2"



ADSON
EK - 457 - 02
27,0 cm / 10 1/2"



CONE

1/2

13,0 cm / 5"

3 X 4

^ EK - 458 - 13

∩ EK - 459 - 13

16,5 cm / 6 1/2"

3 X 4

^ EK - 458 - 16

∩ EK - 459 - 16

20,0 cm / 8"

3 X 4

^ EK - 458 - 20

∩ EK - 459 - 20

25,0 cm / 10"

3 X 4

^ EK - 458 - 25

∩ EK - 459 - 25



BECKMANN

1/2

31,0 cm / 12"

4 X 4

^ EK - 460 - 31

∩ EK - 461 - 31

33,0 cm / 13"

4 X 5

^ EK - 462 - 33

∩ EK - 463 - 33



25 x 25 mm
25 x 31 mm
25 x 40 mm
25 x 45 mm

∧
EK - 464 - 01
EK - 464 - 02
EK - 464 - 03
EK - 464 - 04

∩
EK - 465 - 01
EK - 465 - 02
EK - 465 - 03
EK - 465 - 04

BECKMANN - ADSON
31,0 cm / 12"



BECKMANN - EATON
∧ ∩
EK - 466 - 33 EK - 467 - 33
23,0 cm / 13"



SCALP - CONTOUR
 \wedge \cap
 EK - 467 - 14 EK - 468 - 14
 14,0 cm / 5 1/2"



GELPI
 9,0 cm / 3 1/2" EK - 469 - 09
 11,0 cm / 4 1/2" EK - 469 - 11
 14,0 cm / 5 1/2" EK - 469 - 14
 19,0 cm / 7 1/2" EK - 469 - 19



GELPI
 EK - 470 - 19
 19,0 cm / 7 1/2"



MEYERDİNG
 20,0 cm / 8"
 32 x 25 mm EK - 471 - 01
 54 x 25 mm EK - 471 - 02
 60 x 19 mm EK - 471 - 03
 60 x 25 mm EK - 471 - 04



MARKHAM - MEYERDİNG
 EK - 472 - 01
 18,0 cm / 7"



MARKHAM - MEYERDİNG
 EK - 472 - 02
 18,0 cm / 7"



RIGHBY
18,0 cm / 7"

35 x 20 mm EK - 473 - 01
60 x 20 mm EK - 473 - 02
65 x 15 mm EK - 473 - 03



DARLING
EK - 474 - 01
18,0 cm / 7"



DARLING
EK - 474 - 02
18,0 cm / 7"



PLESTER

EK - 475 - 10 EK - 475 - 13
10,0 cm / 4" 13,0 cm / 5"



PLESTER - R

EK - 476 - 10 EK - 476 - 13
10,0 cm / 4" 13,0 cm / 5"



PLESTER - L

EK - 477 - 10 EK - 477 - 13
10,0 cm / 4" 13,0 cm / 5"



TÜBINGER MODELL
EK - 478 - 16 EK - 478 - 18
16,5 cm / 6 1/2" 18,0 cm / 7 1/2"



RICHTER
EK - 479 - 16
16,5 cm / 6 1/2"



MAYO - ADAMS
EK - 480 - 17
17,0 cm / 6 3/4"

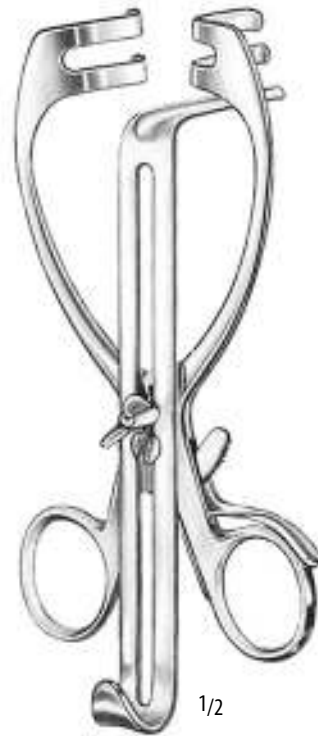

MAYO - ADAMS
EK - 481 - 17
17,0 cm / 6 3/4"



WALTON
EK - 482 - 01
18,0 cm / 7"



WALTON
EK - 482 - 02
18,0 cm / 7"



KNIGHTON
EK - 483 - 01
18,0 cm / 7"



KNIGHTON
EK - 484 - 02
18,0 cm / 7"

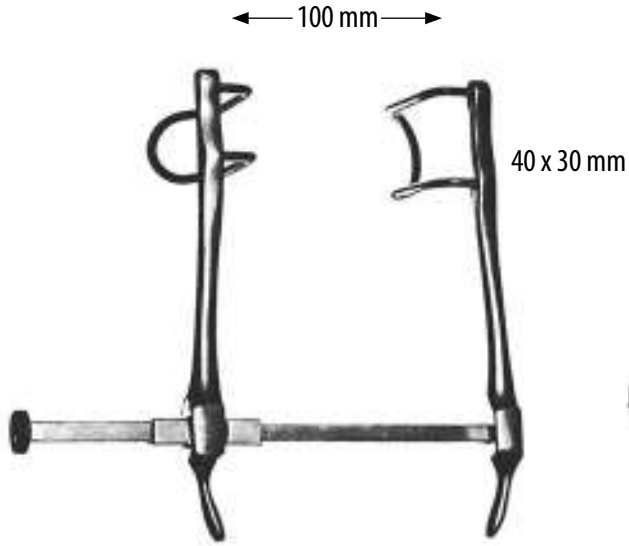

GOSSET
EK - 485 - 10

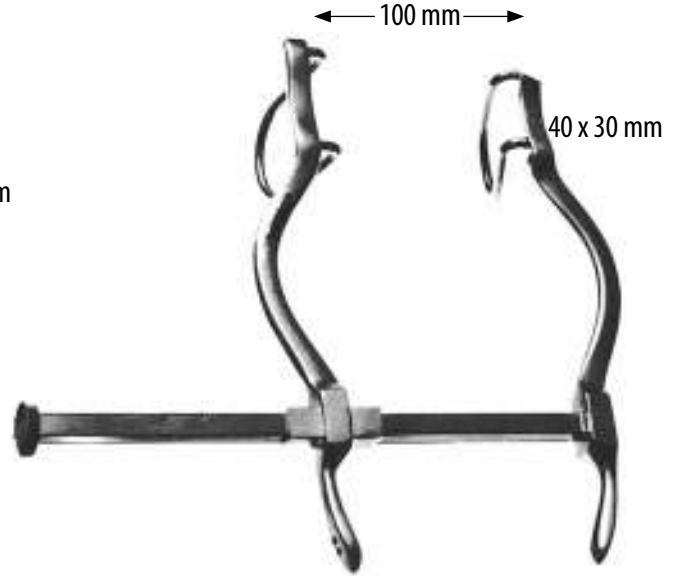

GOSSET
EK - 486 - 10

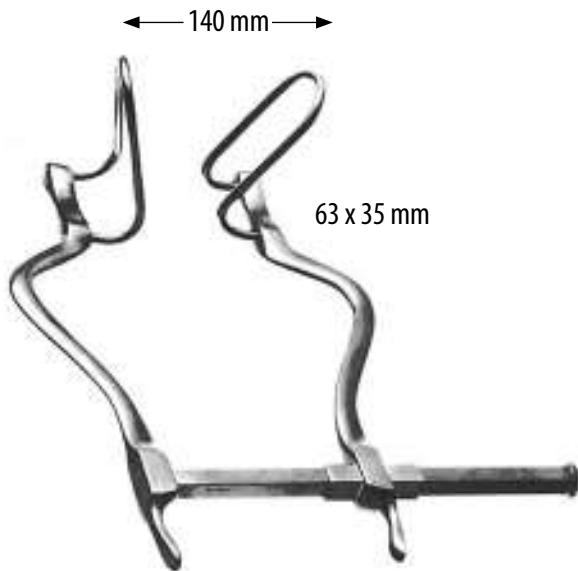

GOSSET
EK - 487 - 14

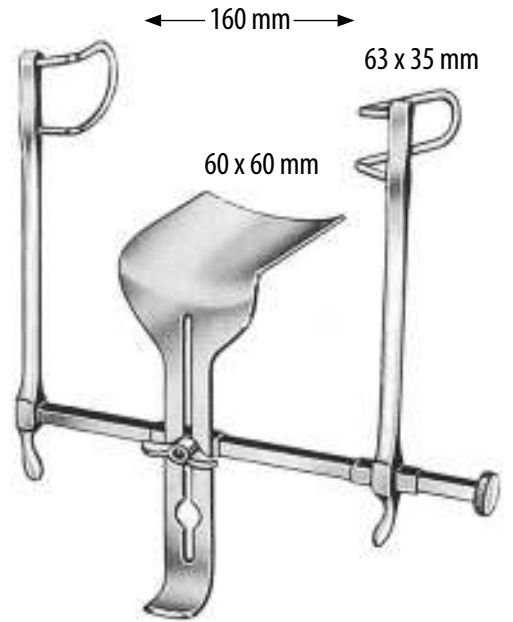

GOSSET
EK - 488 - 16

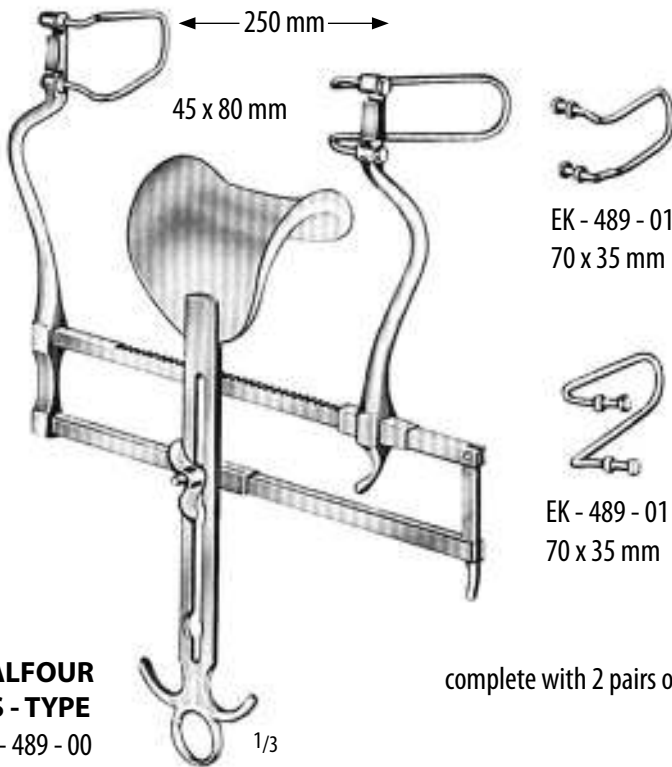

**BALFOUR
US - TYPE**
EK - 489 - 00

1/3

complete with 2 pairs of blades

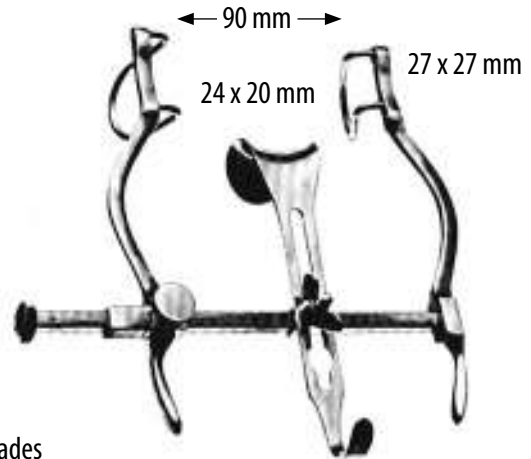

BALFOUR - BABY
EK - 490 - 09

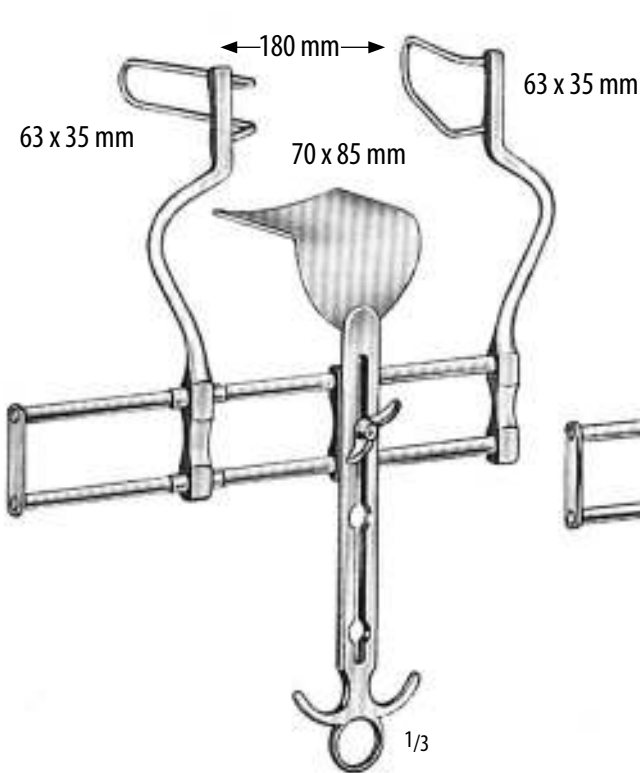

BALFOUR
EK - 491 - 18

1/3

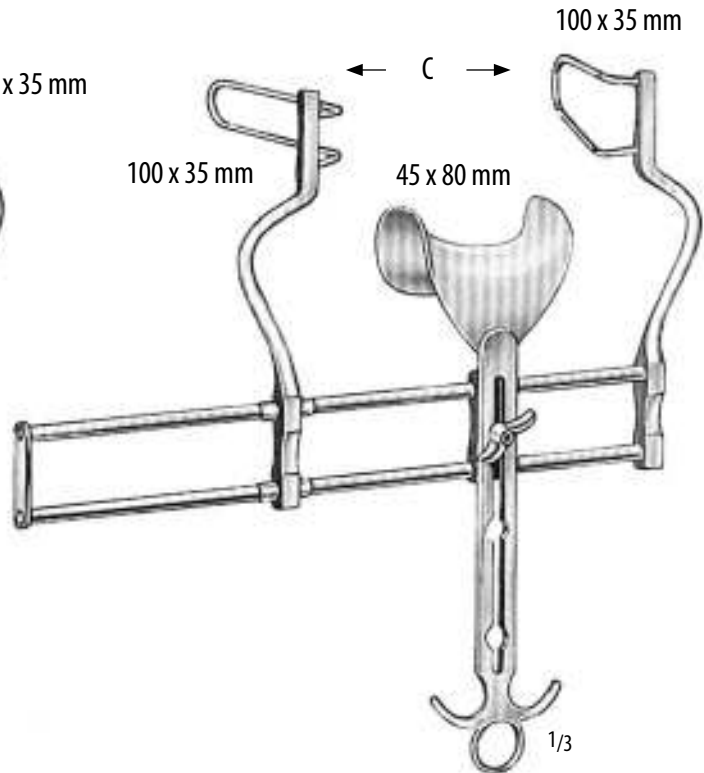

BALFOUR
C = 200 mm EK - 491 - 20
C = 250 mm EK - 491 - 25

1/3

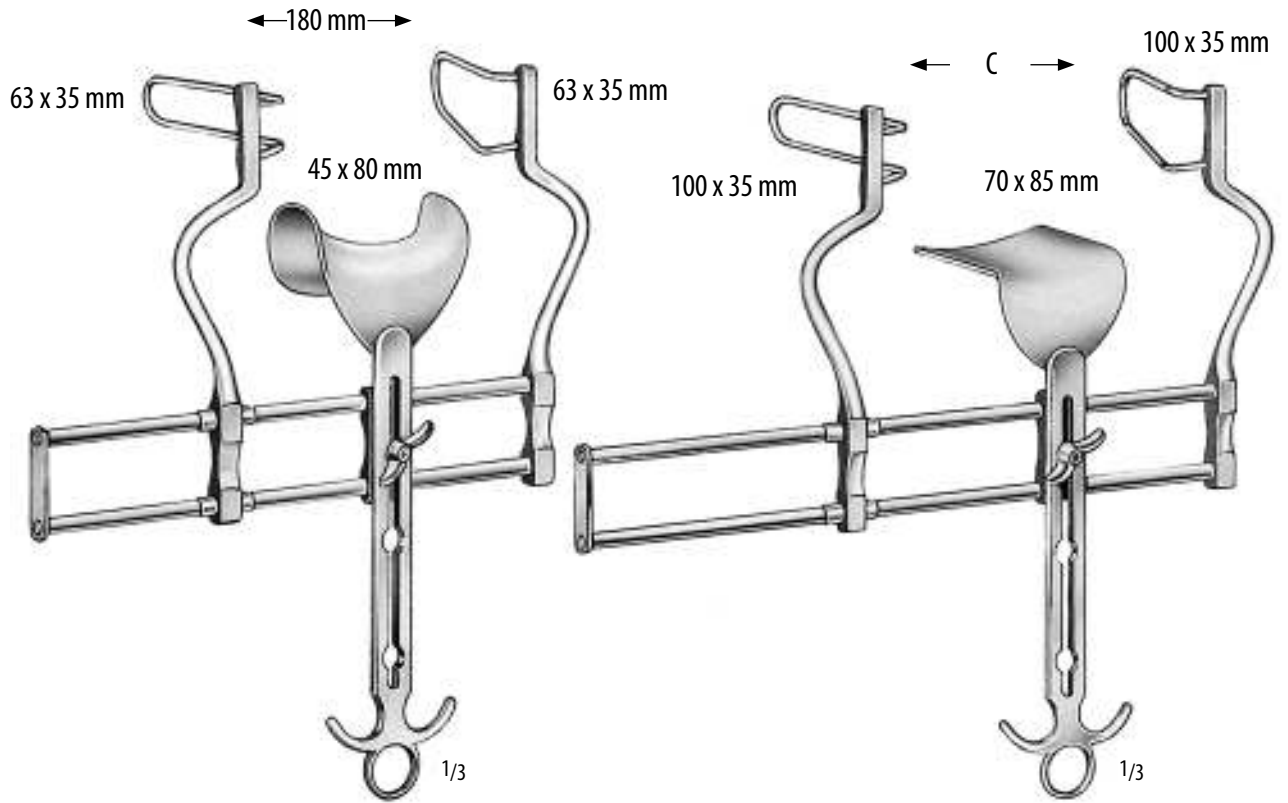

BALFOUR
EK - 492 - 18

BALFOUR
C = 200 mm EK - 492 - 20
C = 250 mm EK - 492 - 25



EK - 493 - 03
100 x 70 mm



BALFOUR
45 x 80 mm EK - 493 - 01
70 x 85 mm EK - 493 - 02

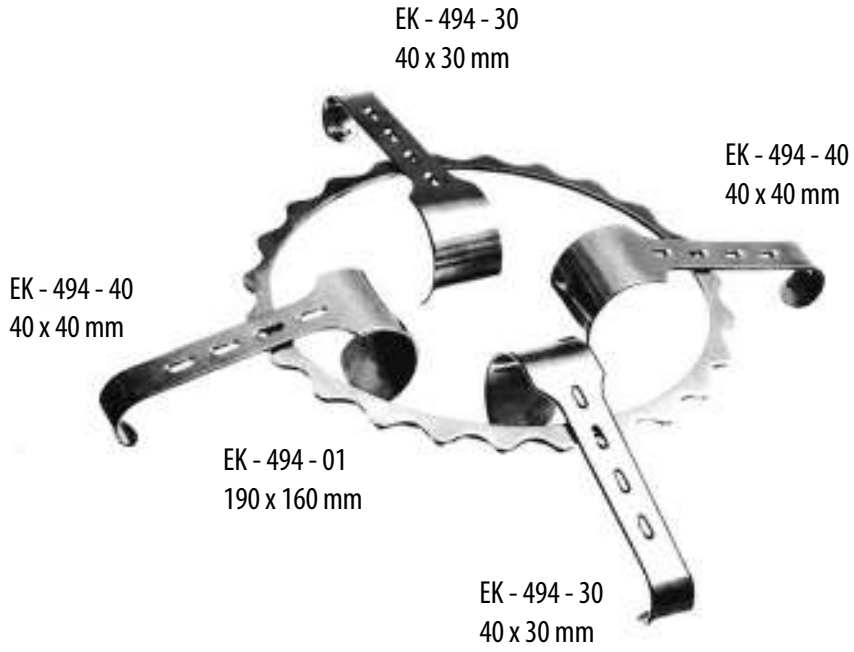

EK - 495 - 01



110 x 70 mm
EK - 495 - 02



80 x 45 mm
EK - 495 - 03



DOYEN

28,0 cm / 11"

- 55 x 95 mm EK - 496 - 01
- 55 x 105 mm EK - 496 - 02
- 55 x 115 mm EK - 496 - 03
- 55 x 125 mm EK - 496 - 04

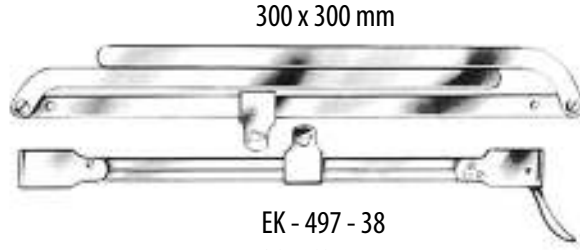

300 x 300 mm

EK - 497 - 38
38 x 60 mm

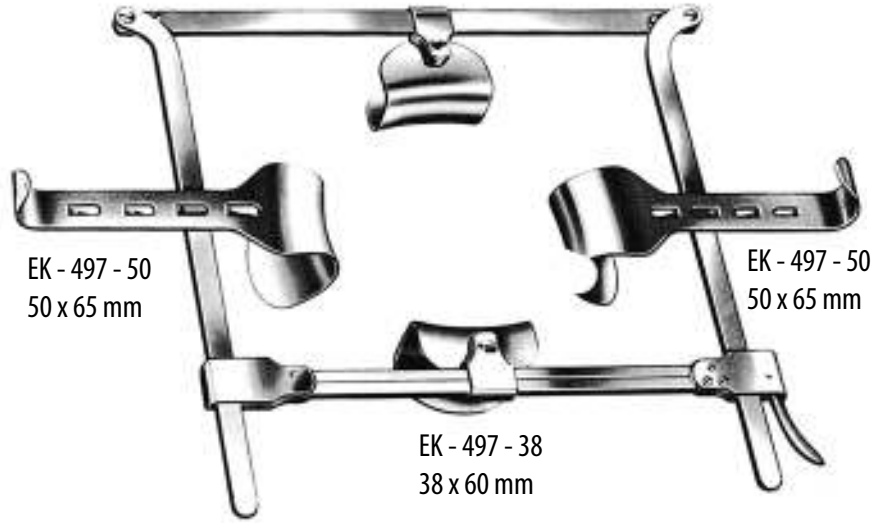

EK - 497 - 50
50 x 65 mm

EK - 497 - 50
50 x 65 mm

EK - 497 - 38
38 x 60 mm

EK - 498 - 45
45 x 80 mm

FRANZ



EK - 498 - 60
60 x 85 mm



EK - 498 - 60
60 x 85 mm



EK - 498 - 45
45 x 80 mm



EK - 499 - 35
105 x 35 mm



EK - 499 - 50
98 x 50 mm

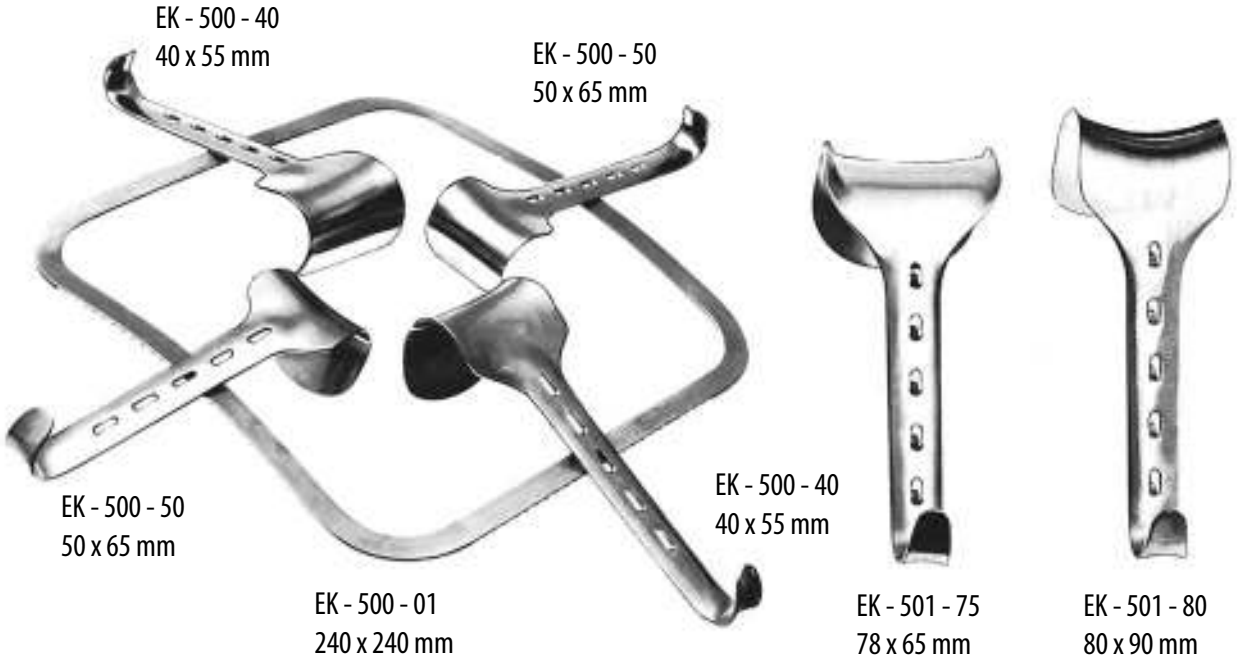

KIRSCHNER

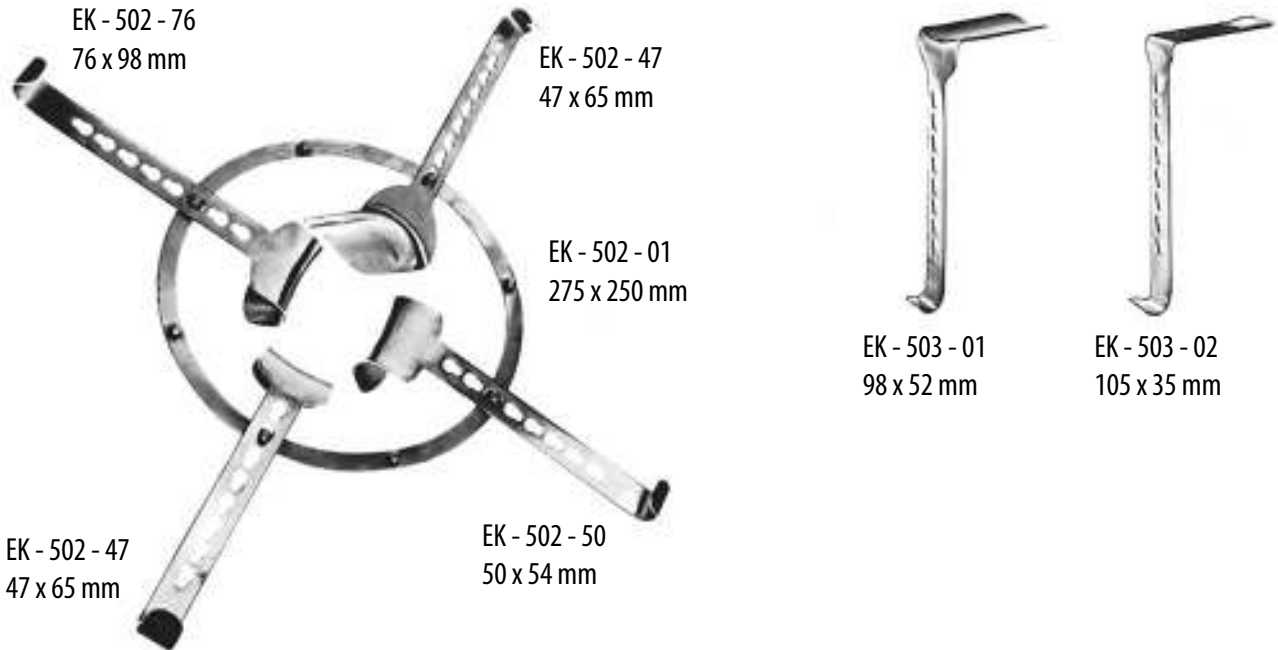

EK - 504 - 23
23 x 44 mm



EK - 504 - 30
30 x 44 mm



COLLIN - BABY

EK - 504 - 00
18,0 cm / 7"

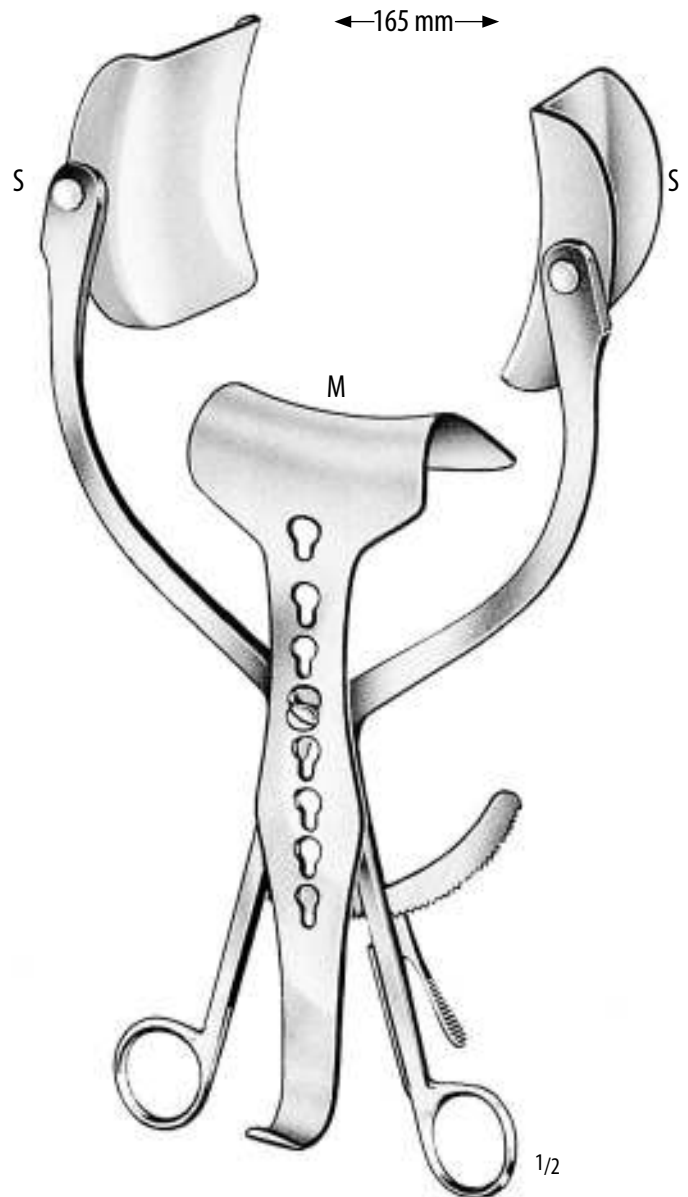

COLLIN

	S	M
EK - 505 - 16	50 x 58 mm	62 x 67 mm
EK - 506 - 16	62 x 80 mm	62 x 67 mm



COLLIN
EK - 507 - 10
22,0 cm / 8³/₄"

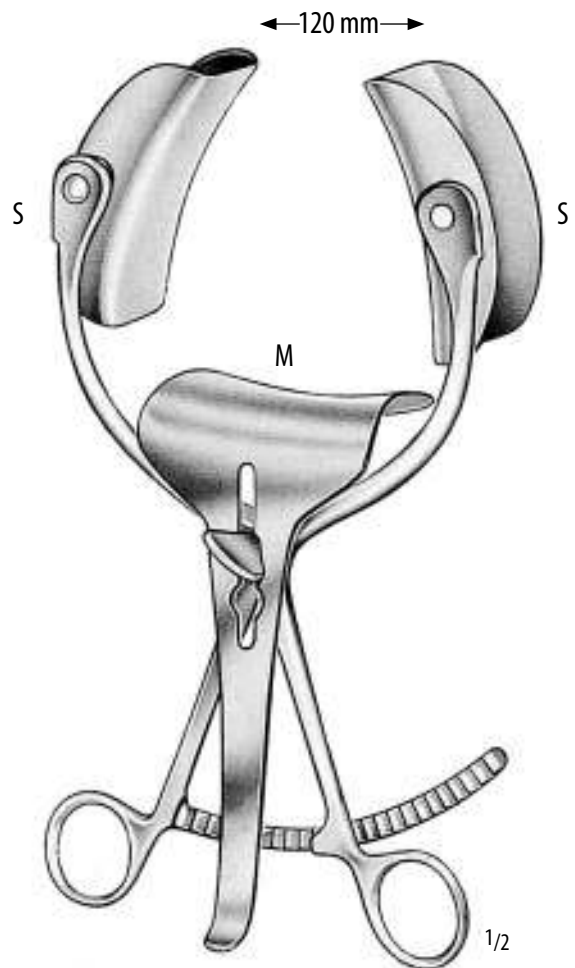

COLLIN

	S	M
EK - 508 - 12	38 x 62 mm	55 x 55 mm
EK - 509 - 12	38 x 80 mm	55 x 65 mm
EK - 510 - 12	38 x 100 mm	55 x 75 mm

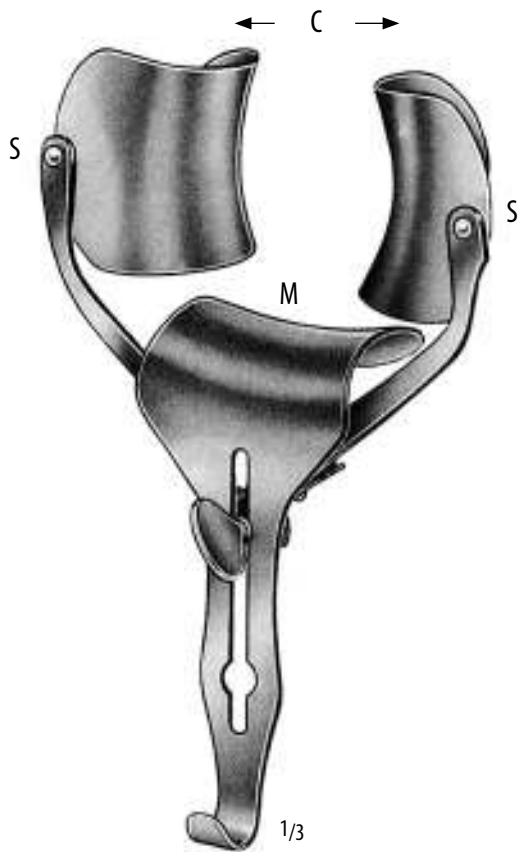

RICARD

	S	M	C
EK - 511 - 28	72 x 85 mm	80 x 90 mm	280 mm
EK - 511 - 30	60 x 80 mm	55 x 70 mm	300 mm

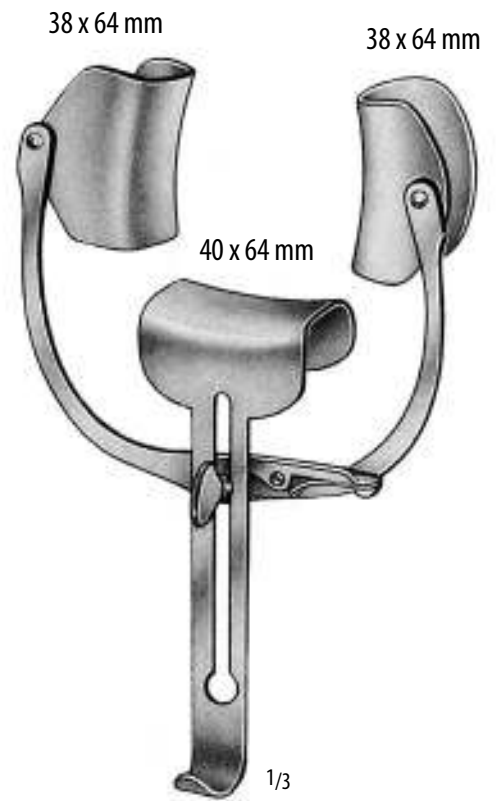

ROBIN - MASSE

EK - 512 - 00



38 x 62 mm EK - 513 - 06
38 x 80 mm EK - 513 - 08
38 x 100 mm EK - 513 - 10



EK - 514 - 80
62 x 80 mm

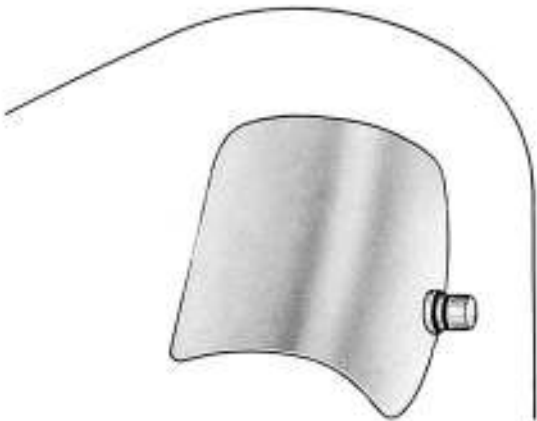

50 x 58 mm EK - 515 - 58
60 x 80 mm EK - 515 - 80
72 x 85 mm EK - 515 - 85



EK - 516 - 80
62 x 80 mm



200 x 12 mm EK - 550 - 12
 200 x 17 mm EK - 550 - 17
 200 x 25 mm EK - 550 - 25
 250 x 25 mm EK - 551 - 25



33,0 cm / 13"
 30 mm EK - 552 - 30
 40 mm EK - 552 - 40
 50 mm EK - 552 - 50

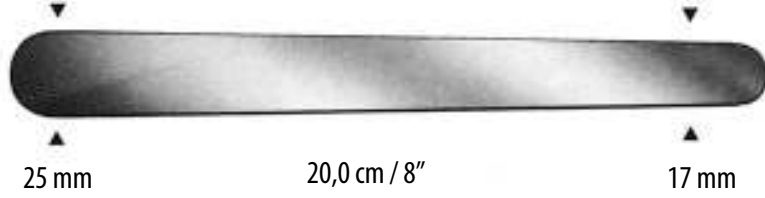

TUFFIER
 EK - 550 - 20



HABERER
 25 / 30 mm 28,0 cm / 11" EK - 554 - 30
 37 / 45 mm 30,0 cm / 12" EK - 554 - 45
 40 / 50 mm 30,0 cm / 12" EK - 554 - 50



REVERDIN
 EK - 555 - 29



SCOVILLE
EK - 660 - 55
55 mm



SCOVILLE
EK - 665 - 25 63 x 25 mm
EK - 665 - 55 63 x 51 mm



TAYLOR
EK - 666 - 37
47 x 37 mm



TAYLOR
EK - 667 - 52
62 x 52 mm

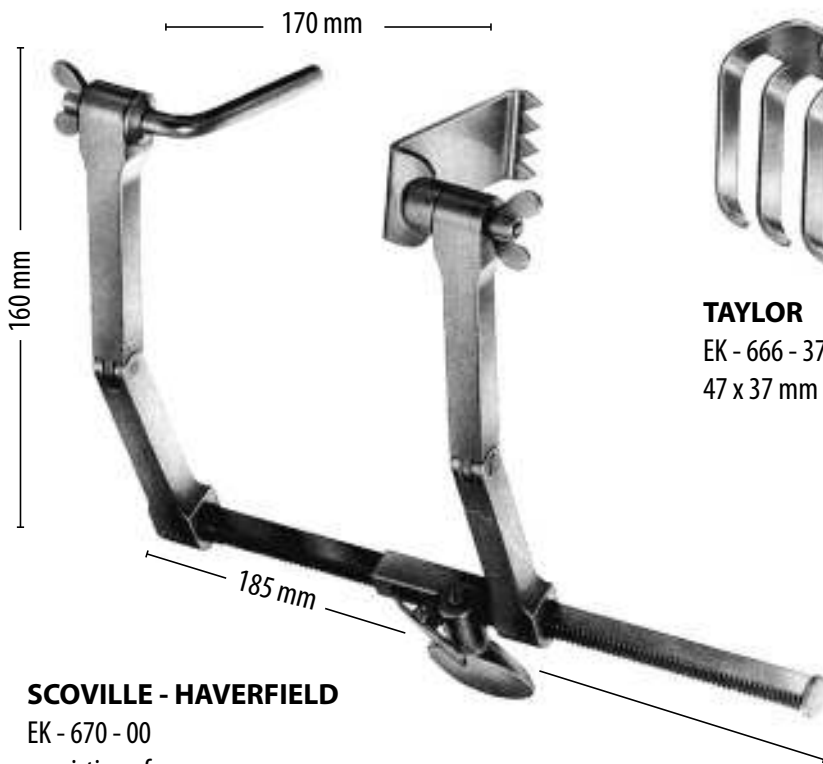

SCOVILLE - HAVERFIELD

EK - 670 - 00
consisting of:

- EK - 670 - 01 Frame only
- EK - 670 - 02 Hook
- EK - 670 - 03 Blade

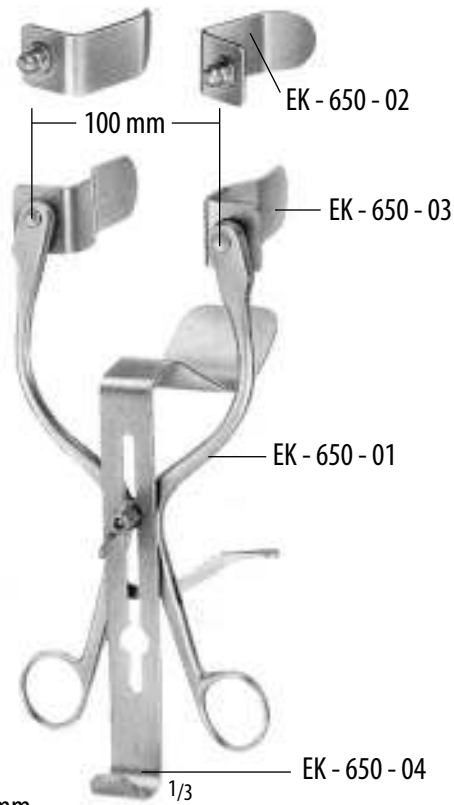

MILLIN
 EK - 650 - 00
Bladder retractor

- EK - 650 - 01 Spreader only
- EK - 650 - 02 Blades 57 x 25 mm
- EK - 650 - 03 Blades 82 x 25 mm
- EK - 650 - 04 Center blade 105 x 45 mm



LEGUEU
 EK - 660 - 00
Bladder retractor
 Center blade 80 x 31 mm



LEGUEU
 EK - 665 - 26
Bladder spatula
 260 mm, 10 1/4"

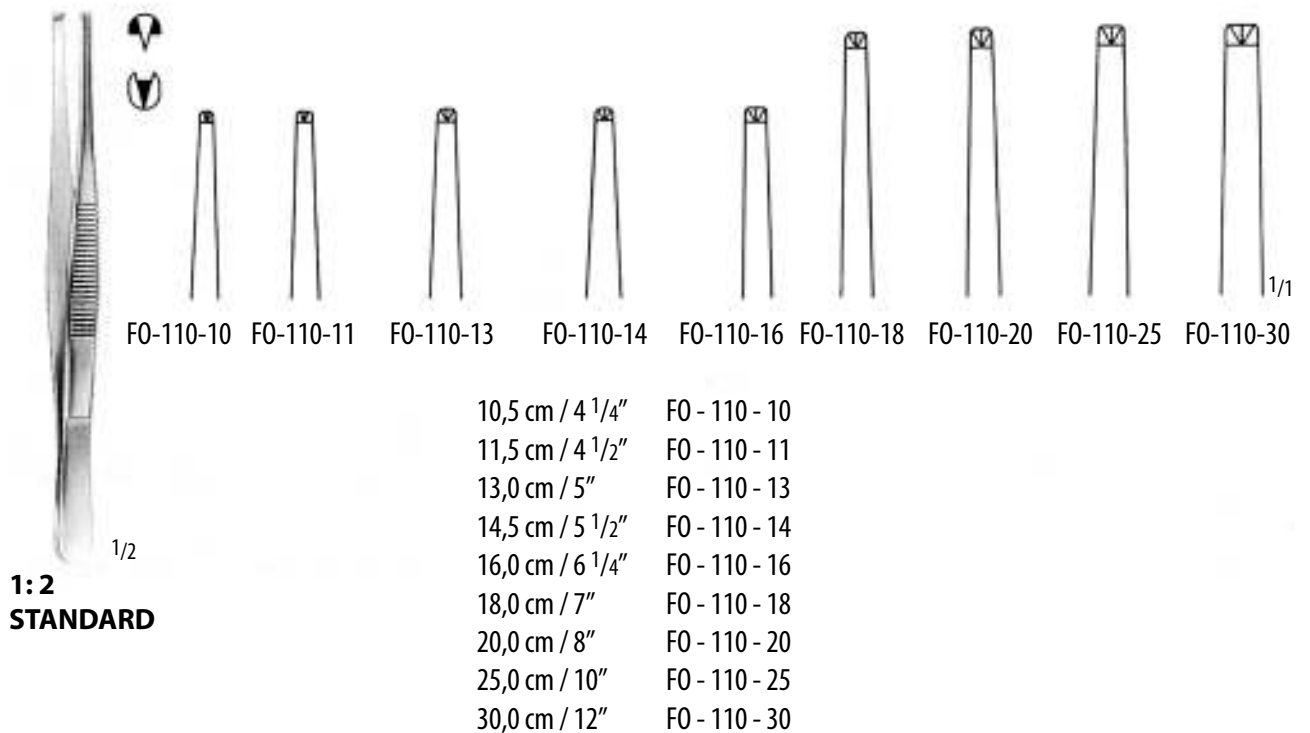
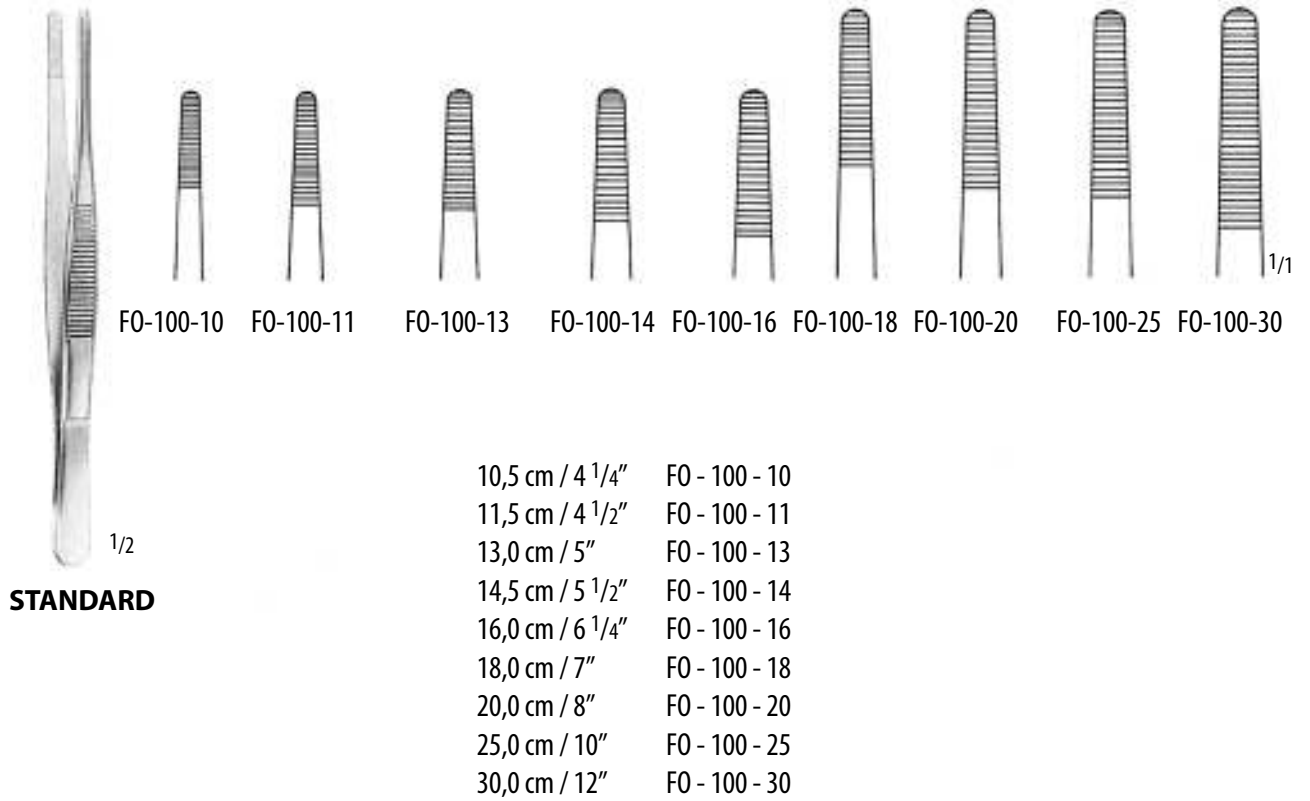



2:3

13,0 cm / 5" FO - 111 - 13
 14,5 cm / 5 1/2" FO - 111 - 14
 16,0 cm / 6 1/4" FO - 111 - 16
 18,0 cm / 7" FO - 111 - 18
 20,0 cm / 8" FO - 111 - 20
 25,0 cm / 10" FO - 111 - 25
 30,0 cm / 12" FO - 111 - 30

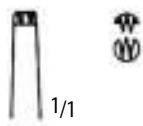

1/1



1/1



1/2

FO - 112 - 13
 FO - 112 - 14
 FO - 112 - 16

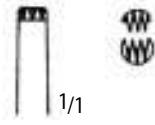

1/1



1/1

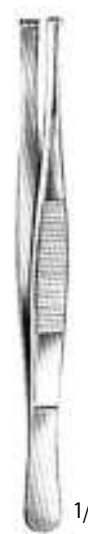

1/2

4:5

FO - 113 - 13
 FO - 113 - 14
 FO - 113 - 16

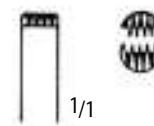

1/1



1/1

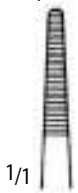

1/1

FO - 120 - 13



1/2



1/1

FO - 221 - 13

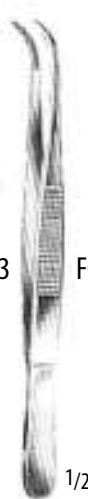

1/2



1/1

FO - 130 - 14



1/2



1/1

FO - 131 - 14

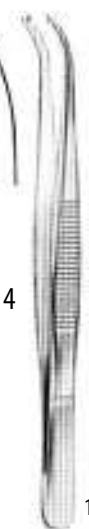

1/2



1/1

FO - 132 - 14



1/2

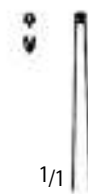

1/1

FO - 133 - 14



1/2

narrow

delicate

10,5 cm / 4 1/4"	FO - 120 - 10	FO - 221 - 10	FO - 130 - 10	FO - 131 - 10
11,5 cm / 4 1/2"	FO - 120 - 11	FO - 221 - 11	FO - 130 - 11	FO - 131 - 11
13,0 cm / 5"	FO - 120 - 13	FO - 221 - 13	FO - 130 - 13	FO - 131 - 13
14,5 cm / 5 1/2"	FO - 120 - 14	FO - 221 - 14	FO - 130 - 14	FO - 131 - 14
16,0 cm / 6 1/4"	FO - 120 - 16	FO - 221 - 16	FO - 130 - 16	FO - 131 - 16
18,0 cm / 7"	FO - 120 - 18	FO - 221 - 18	FO - 130 - 18	FO - 131 - 18
20,0 cm / 8"	FO - 120 - 20	FO - 221 - 20	FO - 130 - 20	FO - 131 - 20
25,0 cm / 10"	FO - 120 - 25	FO - 221 - 25	FO - 130 - 25	FO - 131 - 25
30,0 cm / 12"	FO - 120 - 30	FO - 221 - 30	FO - 130 - 30	FO - 131 - 30

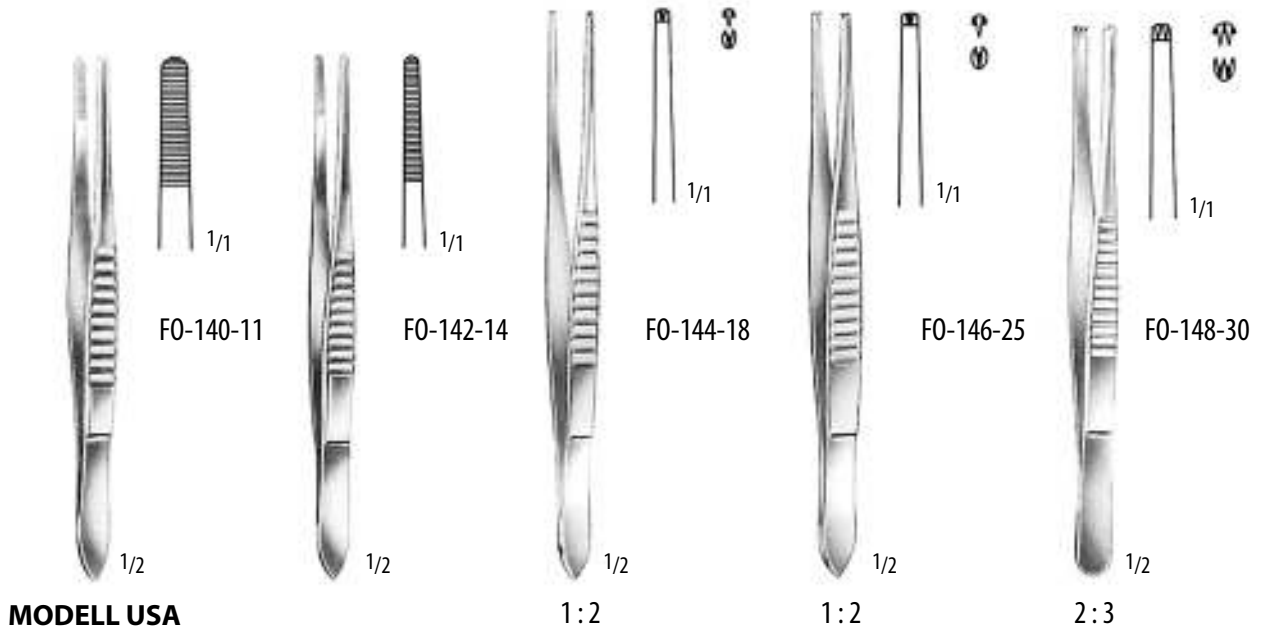

narrow

12,0 cm / 4 ³ / ₄ "	FO - 140 - 12	FO - 142 - 12	FO - 144 - 13	FO - 146 - 12	FO - 148 - 12
13,0 cm / 5"	FO - 140 - 13	FO - 142 - 13	FO - 144 - 14	FO - 146 - 13	FO - 148 - 13
14,5 cm / 5 ¹ / ₂ "	FO - 140 - 14	FO - 142 - 14	FO - 144 - 15	FO - 146 - 14	FO - 148 - 14
15,5 cm / 6"	FO - 140 - 15	FO - 142 - 15		FO - 146 - 15	FO - 148 - 15
18,0 cm / 7"	FO - 140 - 18			FO - 146 - 18	FO - 148 - 18
21,0 cm / 8 ¹ / ₄ "	FO - 140 - 21			FO - 146 - 21	FO - 148 - 21
25,0 cm / 10"	FO - 140 - 25			FO - 146 - 25	FO - 148 - 25
31,0 cm / 12 ¹ / ₄ "	FO - 140 - 31			FO - 146 - 31	FO - 148 - 31

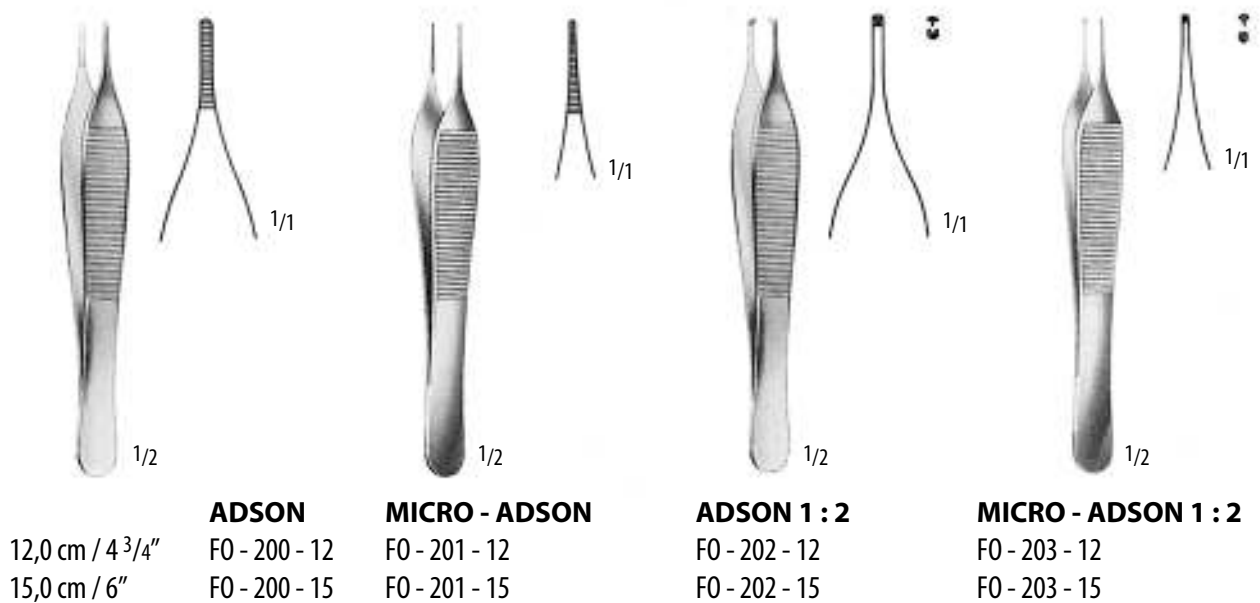

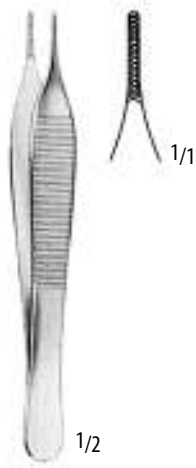

ADSON
FO - 220 - 12
12,0 cm / 4 3/4"

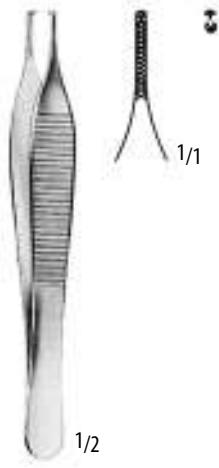

ADSON 1 : 2
FO - 221 - 12
12,0 cm / 4 3/4"



ADSON - BROWN
FO - 222 - 07
12,0 cm / 4 3/4"



ADSON - BROWN
FO - 223 - 09
12,0 cm / 4 3/4"

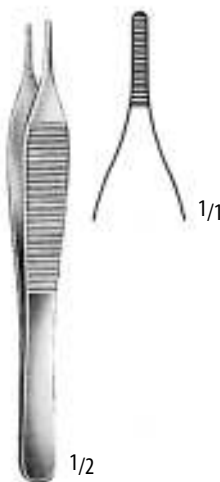

EWALD
FO - 224 - 01
12,0 cm / 4 3/4"

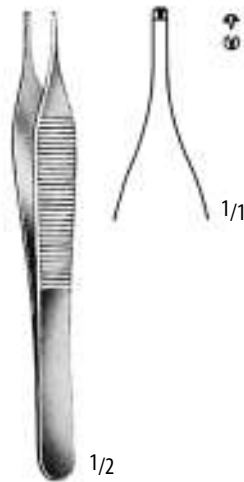

EWALD 1 : 2
FO - 224 - 02
12,0 cm / 4 3/4"



McINDOE
FO - 225 - 15
15,0 cm / 6"



SEMKEN
FO - 226 - 12
FO - 226 - 15

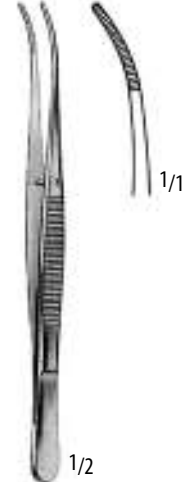

SEMKEN
12,5 cm / 5" FO - 227 - 12
15,5 cm / 6" FO - 227 - 15

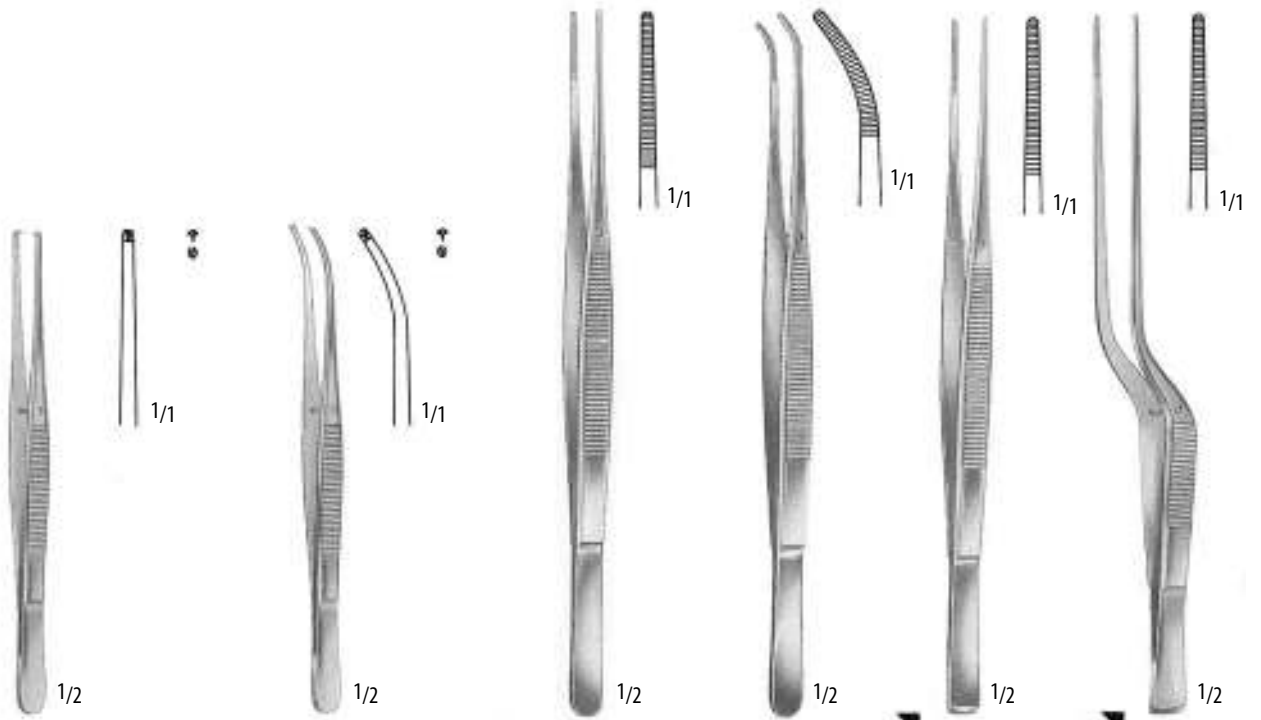

SEMKEN 1:2
 FO - 228 - 12 12,5 cm / 5"
 FO - 228 - 15 15,5 cm / 6"
 FO - 229 - 12
 FO - 229 - 15

TAYLOR
 FO - 230 - 17
 17,5 cm / 7"

TAYLOR
 FO - 231 - 17
 17,5 cm / 7"

TAYLOR
 FO - 232 - 17
 17,5 cm / 7"

TAYLOR
 FO - 233 - 17
 17,5 cm / 7"

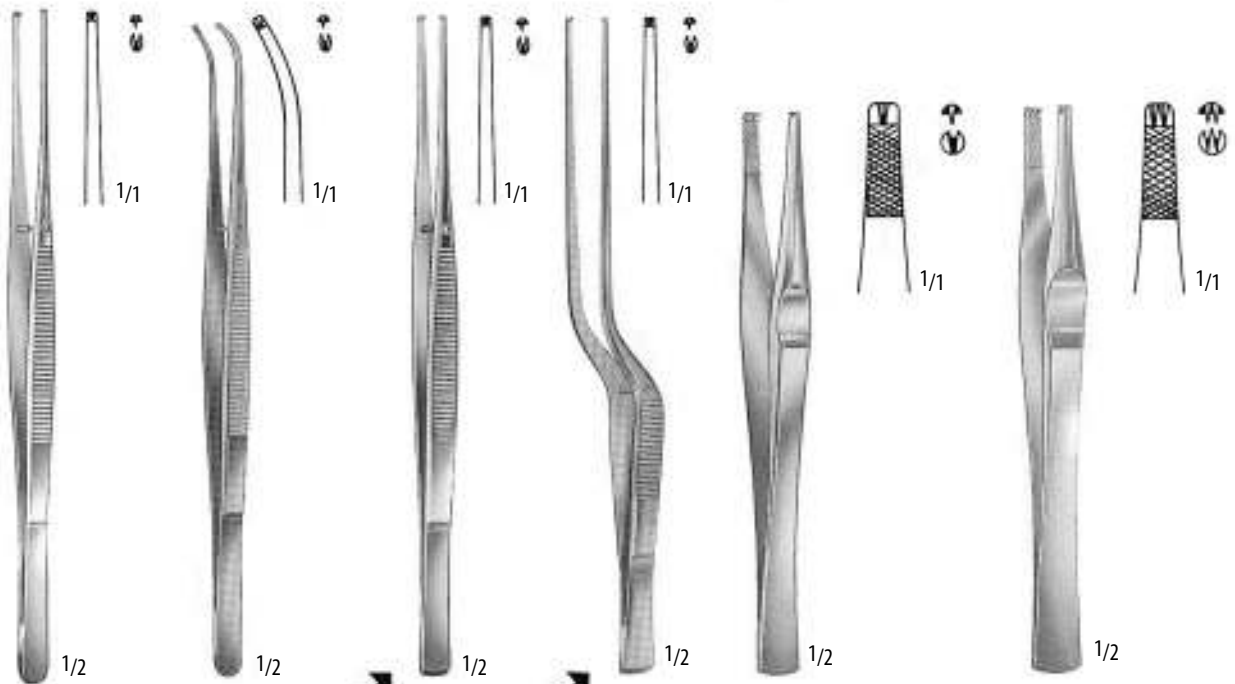

TAYLOR
 1:2
 FO - 240 - 17
 17,5 cm / 7"

TAYLOR
 1:2
 FO - 241 - 17
 17,5 cm / 7"

TAYLOR
 1:2
 FO - 242 - 17
 17,5 cm / 7"

TAYLOR
 1:2
 FO - 243 - 17
 17,5 cm / 7"

LANE
 1:2
 FO - 245 - 14 14,5 cm / 5 1/2"
 FO - 245 - 20 20,0 cm / 8"

LANE
 2:3
 FO - 246 - 14
 FO - 246 - 20

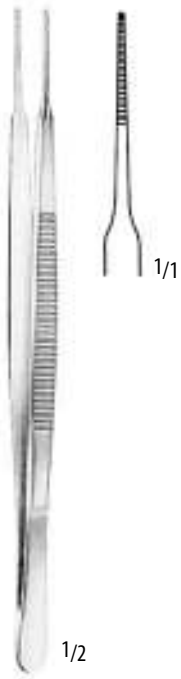

GERALD
FO - 300 - 18 18,0 cm / 7"

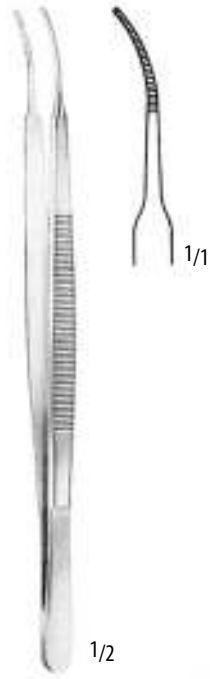

GERALD
FO - 301 - 18



GERALD 1 : 2
FO - 310 - 18 18,0 cm / 7"

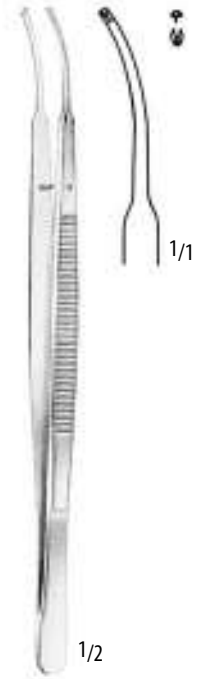

GERALD 1 : 2
FO - 311 - 18



CUSHING
FO - 320 - 17 17,5 cm / 7"



CUSHING
FO - 321 - 17



CUSHING 1 : 2
FO - 325 - 17 17,5 cm / 7"



CUSHING 1 : 2
FO - 326 - 17

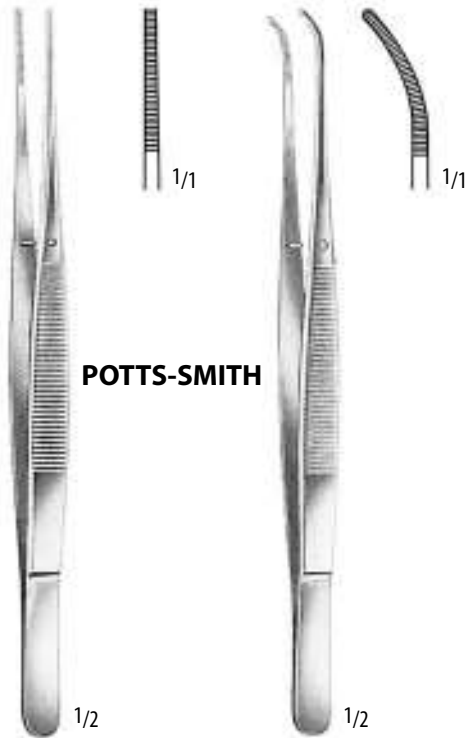

POTTS-SMITH

18,0 cm / 7" FO - 350 - 18 FO - 351 - 18
21,0 cm / 8 1/4" FO - 350 - 21 FO - 351 - 21
25,0 cm / 10" FO - 350 - 25 FO - 351 - 25

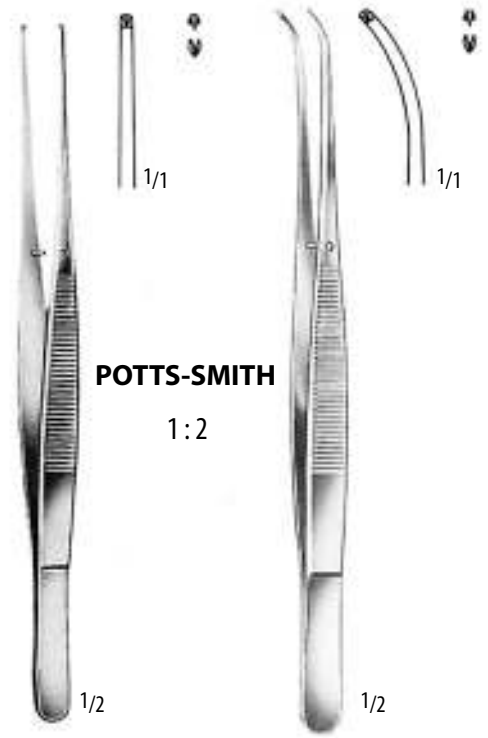

POTTS-SMITH

1:2

FO - 360 - 18 FO - 361 - 18
FO - 360 - 21 FO - 361 - 21
FO - 360 - 25 FO - 361 - 25

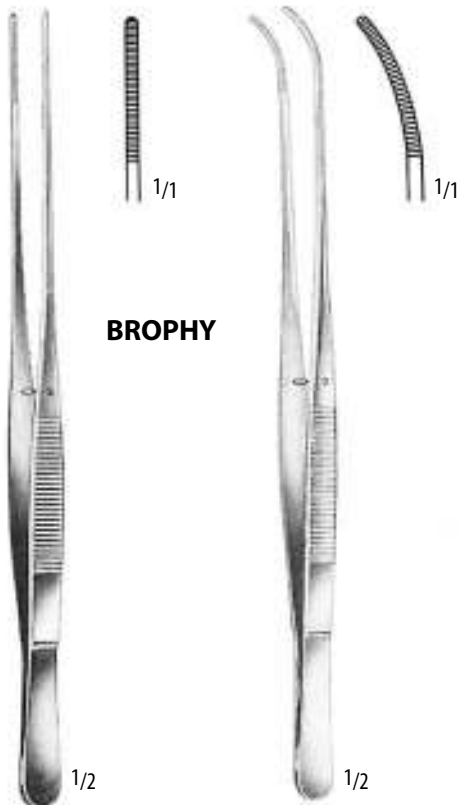

BROPHY

20,0 cm / 8" FO - 370 - 21 FO - 371 - 20

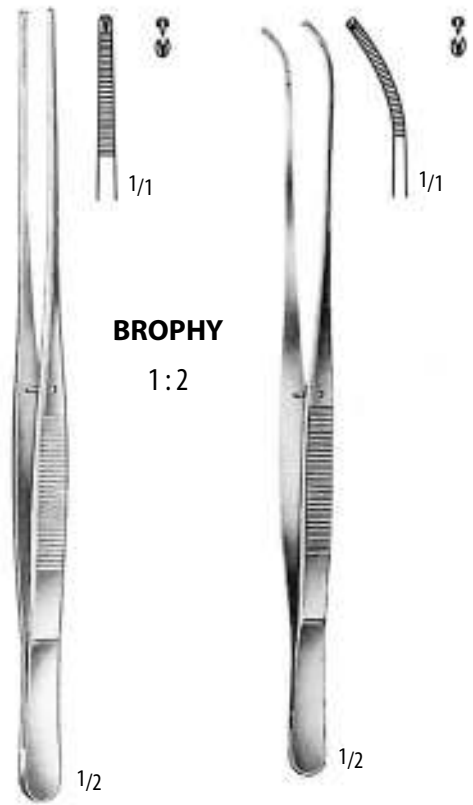

BROPHY

1:2

FO - 375 - 20 FO - 376 - 20

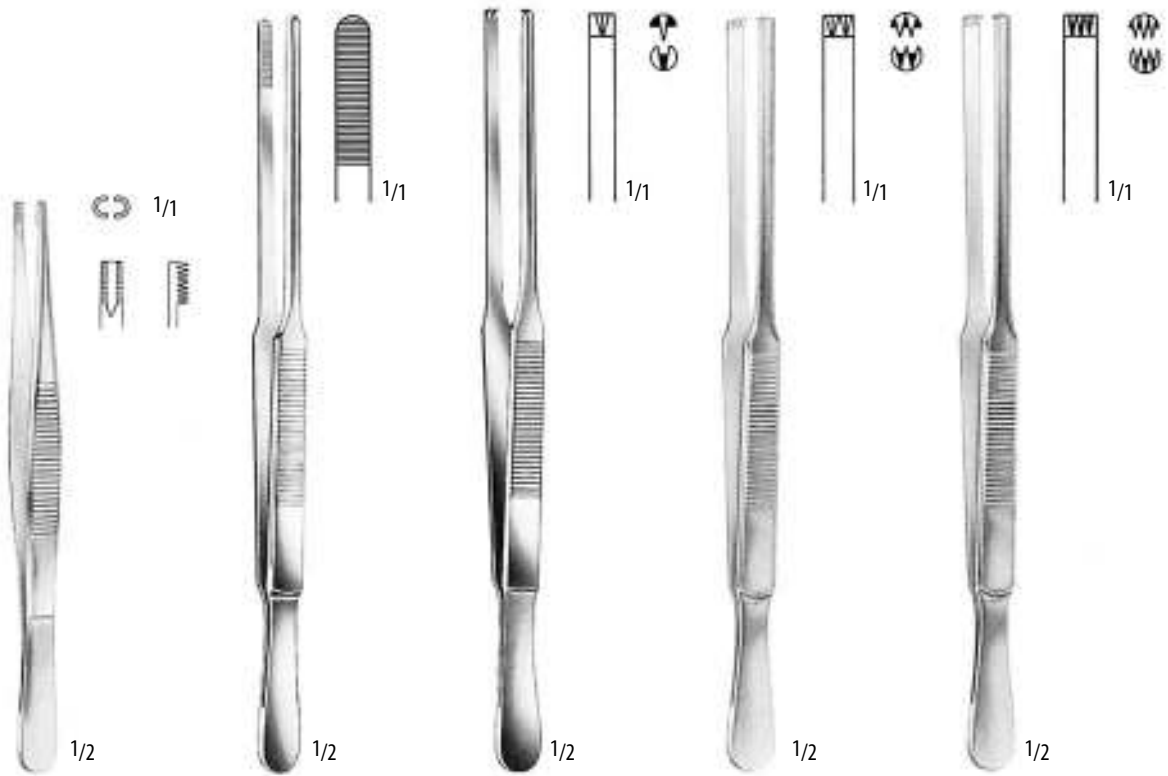

15,0 cm / 6"	BROWN	DUEHRSSSEN	DUEHRSSSEN 1 : 2	DUEHRSSSEN 2 : 3	DUEHRSSSEN 3 : 4
20,0 cm / 8"	FO - 380 - 15	FO - 385 - 20	FO - 386 - 20	FO - 387 - 20	FO - 388 - 20
25,0 cm / 10"	FO - 380 - 20				
	FO - 380 - 25				



WANGENSTEEN

FO - 390 - 23
23,0 cm / 9"



STILLE - BARRAYA 3 : 4

18,0 cm / 7" FO - 391 - 18
20,0 cm / 8" FO - 391 - 20
25,0 cm / 10" FO - 391 - 25

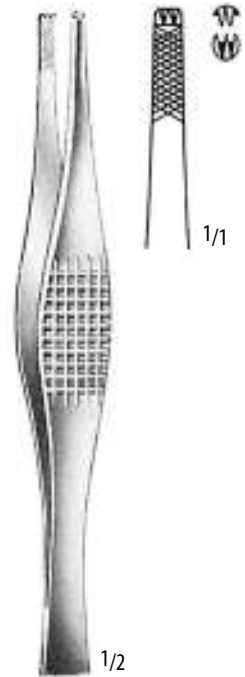

FERRIS - SMITH 2 : 3

FO - 392 - 18
18,0 cm / 7"

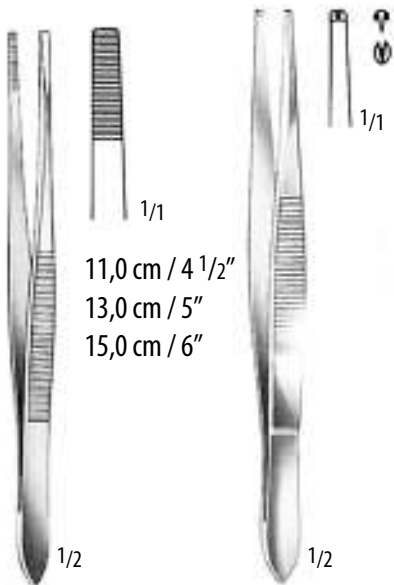

STILLE

FO - 393 - 11
FO - 393 - 13
FO - 393 - 15



STILLE 1 : 2

FO - 394 - 15
15,0 cm / 6"



STILLE 2 : 3

FO - 395 - 15
15,0 cm / 6"

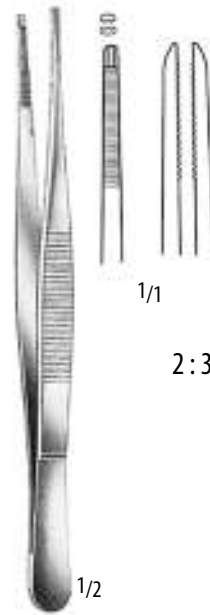

ADLERKREUTZ

15,0 cm / 6" FO - 396 - 15
20,0 cm / 8" FO - 396 - 20
25,0 cm / 10" FO - 396 - 25

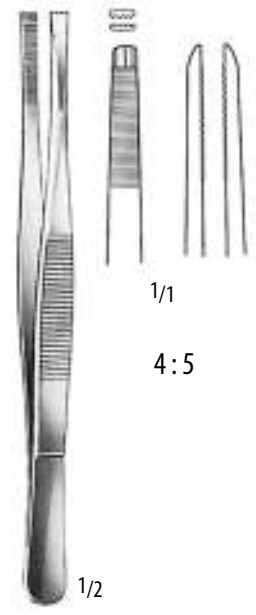

FO - 397 - 15
FO - 397 - 20
FO - 397 - 25



BROWN
20,0 cm / 8"



Fig. 1
FO - 500 - 01



Fig. 2
FO - 500 - 02



Fig. 3
FO - 500 - 03

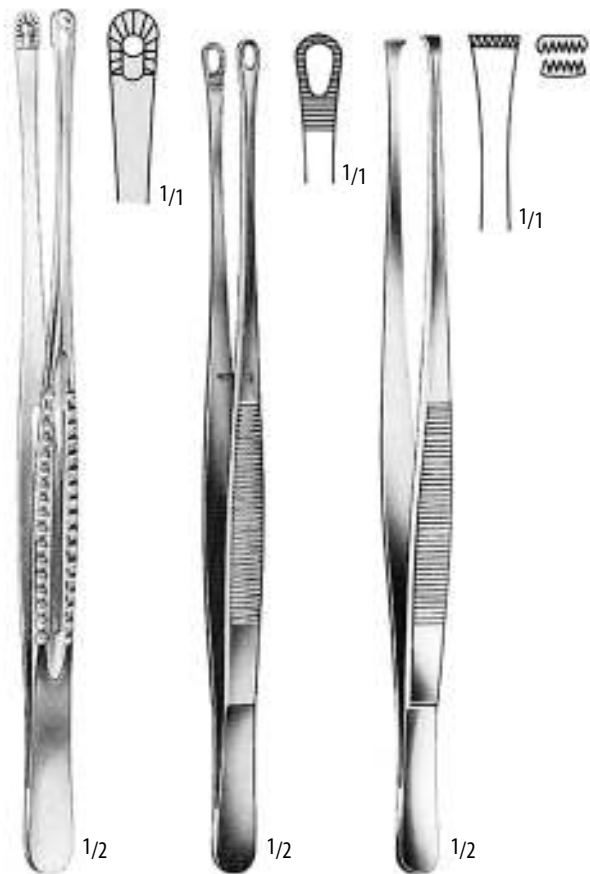

MAYO - RUSS.	SINGLEY - TUTTLE	NELSON
FO - 501 - 23	FO - 502 - 23	FO - 503 - 23
23,0 cm / 9"	23,0 cm / 9"	23,0 cm / 9"

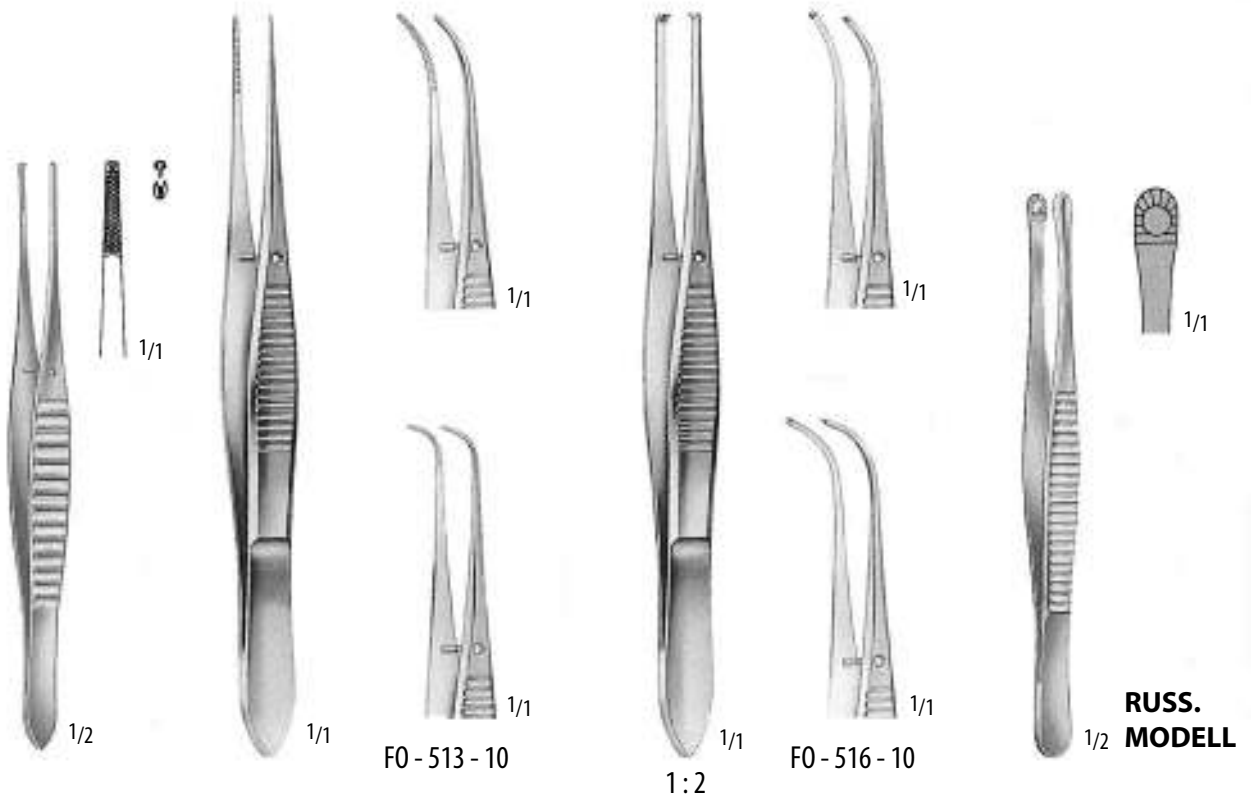

GILLIES 1 : 2
FO - 510 - 15
15,0 cm / 6"

FO - 511 - 10
10,5 cm / 4 1/4"

FO - 513 - 10

FO - 514 - 10
10,5 cm / 4 1/4"

FO - 516 - 10

15,0 cm / 6" FO - 517 - 15
20,0 cm / 8" FO - 517 - 20
25,0 cm / 10" FO - 517 - 25

RUSS. MODELL

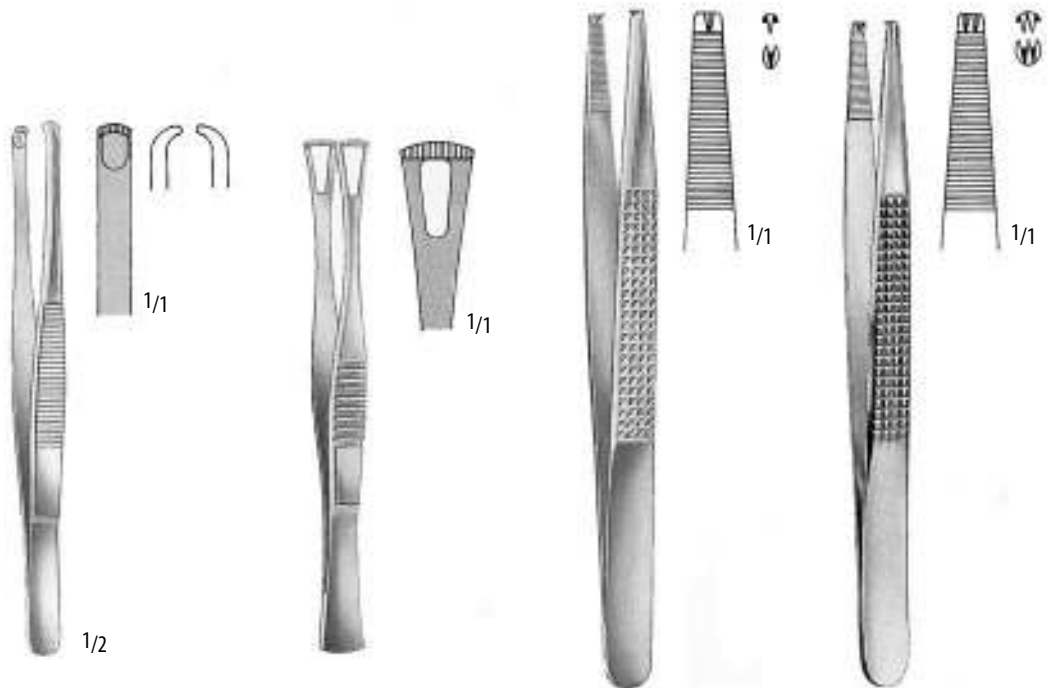









14,5 cm / 5 1/2"
16,0 cm / 6 1/4"
20,0 cm / 8"

DURANTE
FO - 518 - 14
FO - 518 - 16
FO - 518 - 20

DUVAL
FO - 519 - 14
14,5 cm / 5 1/2"

BONNEY 1 : 2
FO - 520 - 18
18,0 cm / 7"

BONNEY 2 : 3
FO - 521 - 18
18,0 cm / 7"

	1/1	No. 1	F0 - 530 - 00 12,0 cm / 4 3/4"
	1/1	No. 2	F0 - 530 - 01 12,0 cm / 4 3/4"
	1/1	No. 3	F0 - 530 - 02 12,0 cm / 4 3/4"
	1/1	No. 4	F0 - 530 - 03 11,0 cm / 4 3/8"
	1/1	No. 5	F0 - 530 - 04 11,0 cm / 4 3/8"
	1/1	No. 5a	F0 - 530 - 05 11,0 cm / 4 3/8"
	1/1	No. 5/45°	F0 - 530 - 07 10,5 cm / 4 1/8"
	1/1	No. 5/90°	F0 - 530 - 10 10,5 cm / 4 1/8"
	1/1	No. 7	F0 - 530 - 11 11,5 cm / 4 1/2"



FO - 531 - 01
Ø 3,0 mm

FO - 531 - 02
Ø 3,0 mm

SAMII
24,0 cm / 9 1/4"

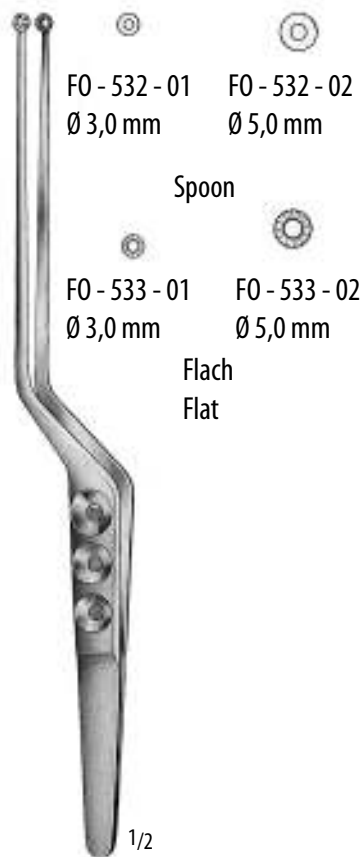

FO - 532 - 01
Ø 3,0 mm

FO - 532 - 02
Ø 5,0 mm

Spoon

FO - 533 - 01
Ø 3,0 mm

FO - 533 - 02
Ø 5,0 mm

Flach
Flat

22,0 cm / 8 3/4"



FO - 534 - 01
Ø 3,0 mm

FO - 534 - 02
Ø 5,0 mm

Curette

HEIFETZ
22,0 cm / 8 3/4"



Ø 5,0 mm

HUNT
FO - 535 - 20
20,0 cm / 8"

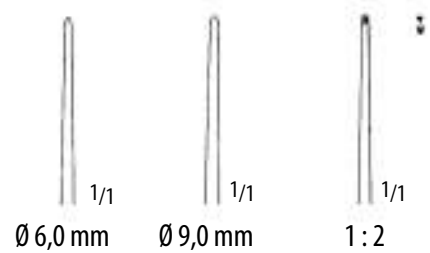

16,0 cm / 6 1/4" FO - 536 - 16 FO - 537 - 16 FO - 538 - 18
18,0 cm / 7" FO - 536 - 18 FO - 537 - 18
20,0 cm / 8" FO - 536 - 20 FO - 537 - 20
22,0 cm / 8 3/4" FO - 536 - 22 FO - 537 - 22
24,0 cm / 9 1/2" FO - 536 - 24 FO - 537 - 24

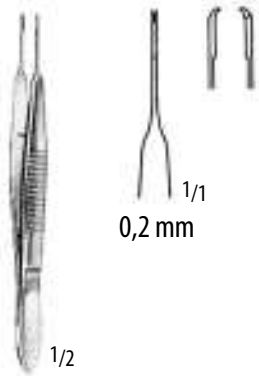

1 : 2
FO - 601 - 09
9,5 cm / 3 3/4"

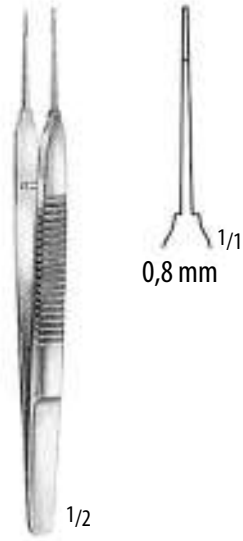

AUSTIN
FO - 602 - 14
14,0 cm / 5 1/2"

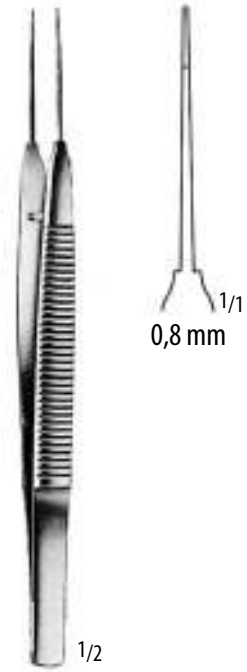

AUSTIN
FO - 602 - 18
18,0 cm / 7"

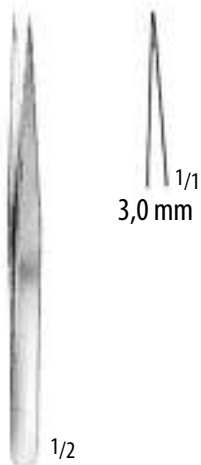

FO - 603 - 12
12,0 cm / 4 3/4"

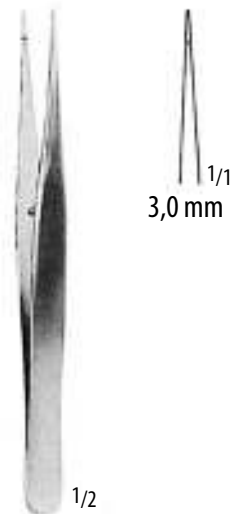

WISE
FO - 603 - 13
13,5 cm / 5 1/4"

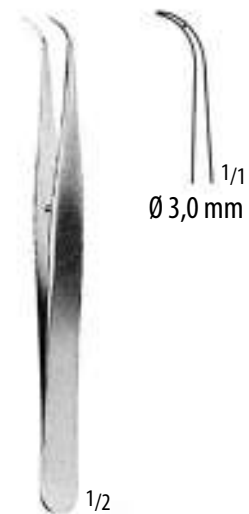

WISE
FO - 604 - 13
13,5 cm / 5 1/4"



FO - 605 - 14
14,0 cm / 5 1/2"



FO - 606 - 14
14,0 cm / 5 1/2"



FO - 607 - 14
14,0 cm / 5 1/2"



12,0 cm / 4 3/4"
15,0 cm / 6"

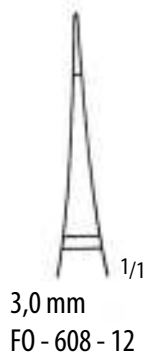

3,0 mm
FO - 608 - 12

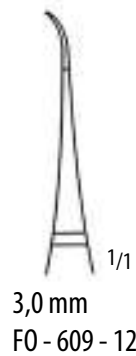

3,0 mm
FO - 609 - 12



18,0 cm / 7"



FO - 612 - 18



FO - 613 - 18



FO - 614 - 11
11,0 cm / 4 1/2"



1/1

FEILCHENFELD

7,5 cm / 3" FO - 615 - 07
 9,0 cm / 3 1/2" FO - 615 - 09
 11,5 cm / 4 1/2" FO - 615 - 11



1/1



1/1

HUNTER

FO - 616 - 10
 10,5 cm / 4 1/4"



1/1



1/1

HUNTER

FO - 617 - 10
 10,5 cm / 4 1/4"



1/1



1/1

WALTER - CARMALT

FO - 618 - 10
 10,5 cm / 4 1/4"



1/1



1/1

WALTER - CARMALT

FO - 619 - 10
 10,5 cm / 4 1/4"



1/1

8,0 cm / 3 1/4"
 9,0 cm / 3 1/2"
 10,5 cm / 4 1/4"
 11,5 cm / 4 1/2"
 12,5 cm / 5"
 14,5 cm / 5 1/2"



1/1

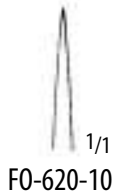

1/1
 FO-620-10

FO-620-08
 FO-620-09
 FO-620-10
 FO-620-11
 FO-620-12
 FO-620-14



1/1

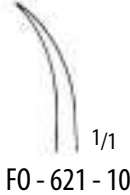

1/1
 FO - 621 - 10

FO-621-08
 FO-621-09
 FO-621-10
 FO-621-11
 FO-621-12
 FO-621-14



1/1

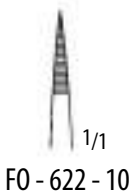

1/1
 FO - 622 - 10

FO-622-08
 FO-622-09
 FO-622-10
 FO-622-11
 FO-622-12
 FO-622-14



1/1

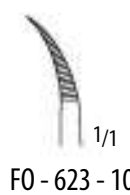

1/1
 FO - 623 - 10

FO-623-08
 FO-623-09
 FO-623-10
 FO-623-11
 FO-623-12
 FO-623-14



1/1
FO-624-10



1/1
FO-625-10



1/1
FO-626-10



1/1
FO-627-10

8,0 cm / 3 1/4" FO-624-08
9,0 cm / 3 1/2" FO-624-09
10,5 cm / 4 1/4" FO-624-10
11,5 cm / 4 1/2" FO-624-11
12,5 cm / 5" FO-624-12
14,5 cm / 5 1/2" FO-624-14

FO-625-08
FO-625-09
FO-625-10
FO-625-11
FO-625-12
FO-625-14

FO-626-08
FO-626-09
FO-626-10
FO-626-11
FO-626-12
FO-626-14

FO-627-08
FO-627-09
FO-627-10
FO-627-11
FO-627-12
FO-627-14

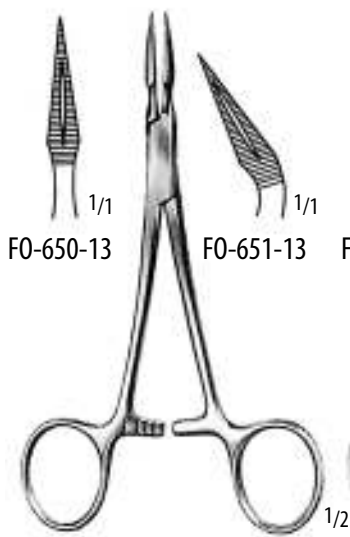

1/1
FO-650-13



1/1
FO-651-13

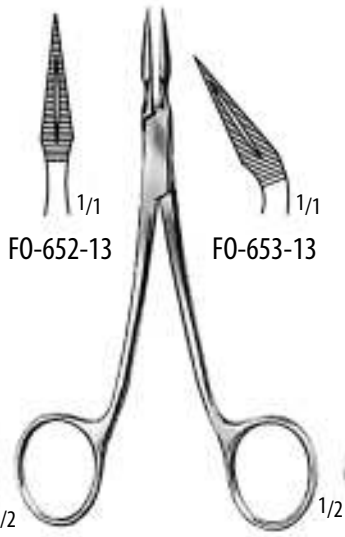

1/1
FO-652-13



1/1
FO-653-13

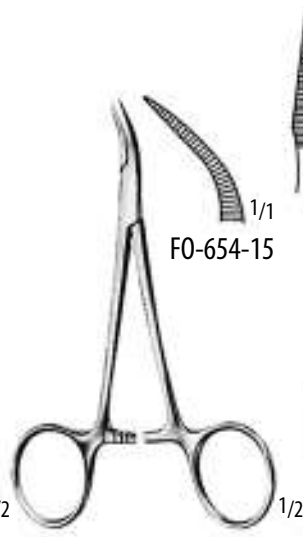

1/1
FO-654-15

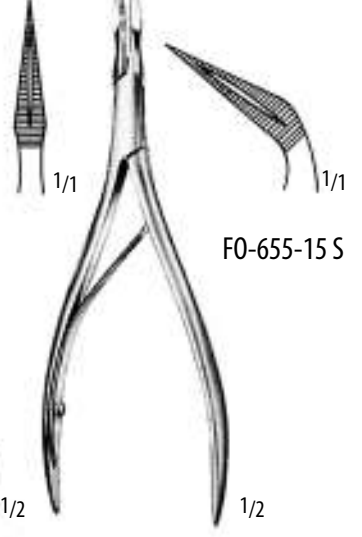

1/1
FO-655-15 S

STIEGLITZ
13,5 cm / 5 1/2"

STIEGLITZ
13,5 cm / 5 1/2"

PEET
11,5 cm / 4 1/2"

RALK
15,0 cm / 6"



LITTAUER
FO - 675 - 08
8,5 cm / 3 1/2"



FO - 676 - 09
9,0 cm / 3 1/2"



DOUGLAS
FO - 677 - 09
9,0 cm / 3 1/2"



BEER
FO - 678 - 09
9,0 cm / 3 1/2"



ZIEGLER
FO - 679 - 09
9,0 cm / 3 1/2"



BARRAQUER
FO - 680 - 10
10,5 cm / 4 1/4"



GRADLE
FO - 681 - 09
9,5 cm / 3 3/4"

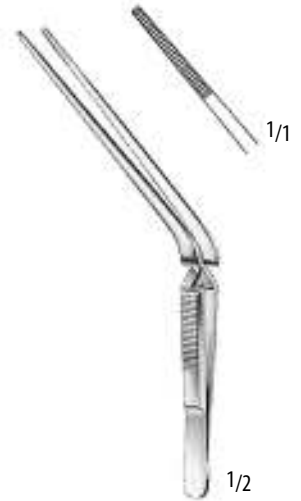

11,0 cm / 4 1/2"
12,0 cm / 4 3/4"
15,0 cm / 6"
18,0 cm / 7"

TROELTSCH (WILDE)
FO - 700 - 11
FO - 700 - 12
FO - 700 - 15
FO - 700 - 18

TROELTSCH (WILDE) 1 : 2
FO - 701 - 12
FO - 701 - 15
FO - 701 - 18

**TROELTSCH (WILDE)
Mod. Jalasvirta**
FO - 702 - 11 FO - 702 - 13
11,0 cm / 4 1/2" 13,0 cm / 5"

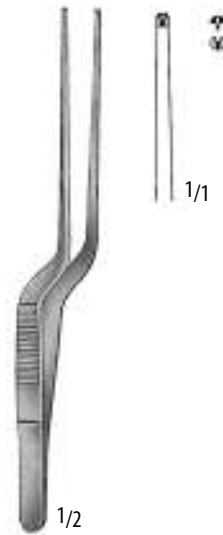

LUCAE
FO - 703 - 14
14,0 cm / 5 1/2"

LUCAE 1 : 2
FO - 704 - 14
14,0 cm / 5 1/2"

JANSEN
16,0 cm / 6 1/4" FO - 705 - 16
18,0 cm / 7" FO - 705 - 18
20,0 cm / 8" FO - 705 - 20



GRUENWALD (JANSEN)
FO - 710 - 20
20,0 cm / 8"

1/2

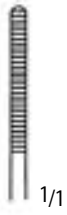

1/1



KUEHNE
FO - 714 - 10
10,5 cm / 4 1/4"

1/1



1/1



GRUENWALD 1 : 2
FO - 711 - 20
20,0 cm / 8"

1/2



1/1



KUEHNE
FO - 715 - 10
10,5 cm / 4 1/4"

1/1



1/1

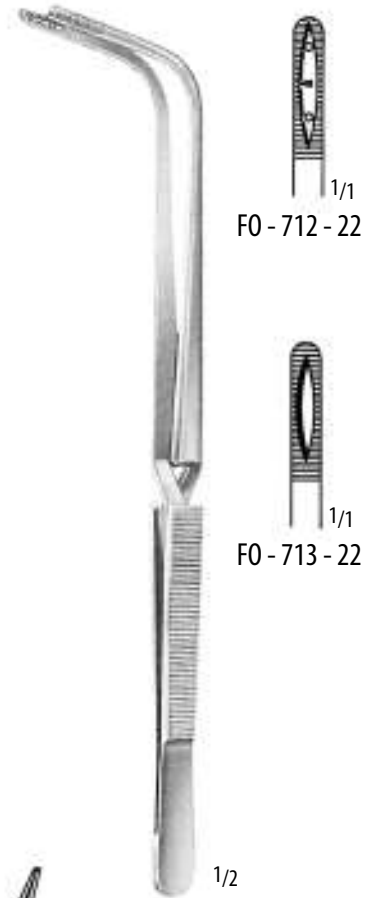

JACKSON
22,0 cm / 8 3/4"

1/2

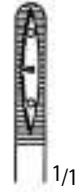

1/1

FO - 712 - 22

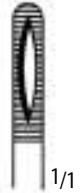

1/1

FO - 713 - 22

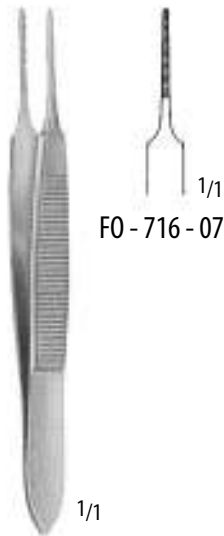

FO - 716 - 07

1/1

GRAEFE

7,0 cm / 2 3/4"

0,5 mm FO - 716 - 05

0,7 mm FO - 716 - 07

1,0 mm FO - 716 - 10

FO - 716 - 12

FO - 716 - 14

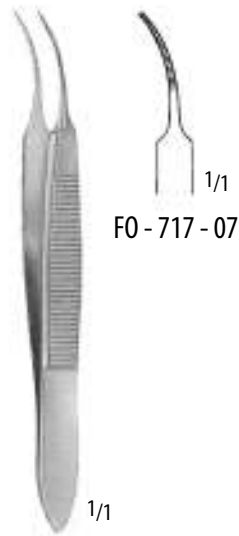

FO - 717 - 07

1/1

GRAEFE

7,0 cm / 2 3/4"

FO - 717 - 05

FO - 717 - 07

FO - 717 - 10

FO - 717 - 12

FO - 717 - 14

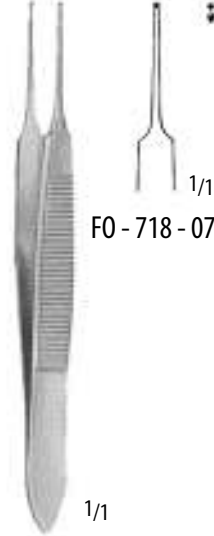

FO - 718 - 07

1/1

GRAEFE 1 : 2

7,0 cm / 2 3/4"

FO - 718 - 05

FO - 718 - 07

FO - 718 - 10

FO - 718 - 12

FO - 718 - 14



FO - 719 - 07

1/1

GRAEFE 1 : 2

7,0 cm / 2 3/4"

FO - 719 - 05

FO - 719 - 07

FO - 719 - 10

FO - 719 - 12

FO - 719 - 14



7,0 cm / 2 3/4"

10,0 cm / 4"

1/1

GRAEFE

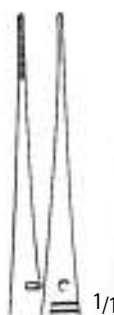

1/1

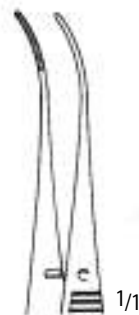

1/1



1/1

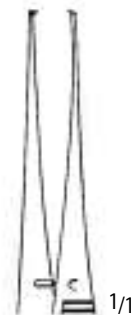

1/1

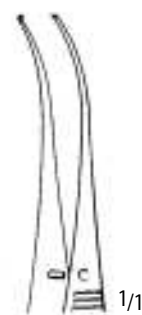

1/1

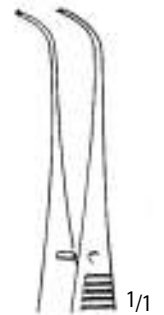

1/1

FO - 801 - 07

FO - 802 - 07

FO - 803 - 07

FO - 804 - 07

FO - 805 - 07

FO - 806 - 07

FO - 801 - 10

FO - 802 - 10

FO - 803 - 10

FO - 804 - 10

FO - 805 - 10

FO - 806 - 10

FO - 801 - 12

FO - 802 - 12

FO - 803 - 12

FO - 804 - 12

FO - 805 - 12

FO - 806 - 12



STEVENS 1 : 2
FO - 815 - 01
11,0 cm / 4 1/2"



STEVENS 1 : 2
FO - 815 - 02
11,0 cm / 4 1/2"



STEVENS
10,5 cm / 4 1/2"



FO - 816 - 01



FO - 816 - 02



FO - 816 - 03

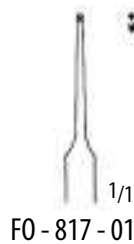

FO - 817 - 01

1:2



FO - 817 - 02

1:2

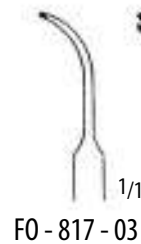

FO - 817 - 03

1:2



FISCHER - ARLT 1 : 2
FO - 818 - 07
7,0 cm / 2 3/4"



FOERSTER
FO - 819 - 08
8,5 cm / 3 1/2"



FOERSTER
FO - 820 - 08
8,5 cm / 3 1/2"



FOERSTER 1 : 2
FO - 821 - 08
8,5 cm / 3 1/2"



FOERSTER 1 : 2
FO - 822 - 08
8,5 cm / 3 1/2"

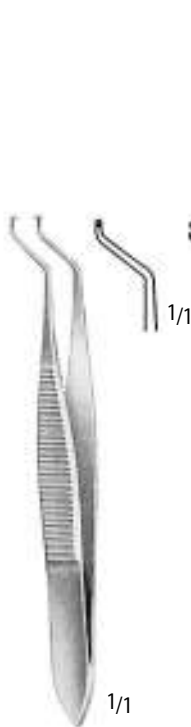

HESS 1 : 2
FO - 823 - 07
7,0 cm / 2 3/4"



HESS 1 : 2
FO - 824 - 09
9,0 cm / 3 1/2"



MOD. BONN 1 : 2
FO - 825 - 01
7,0 cm / 2 3/4"



MOD. BONN 1 : 2
FO - 825 - 02
7,0 cm / 2 3/4"

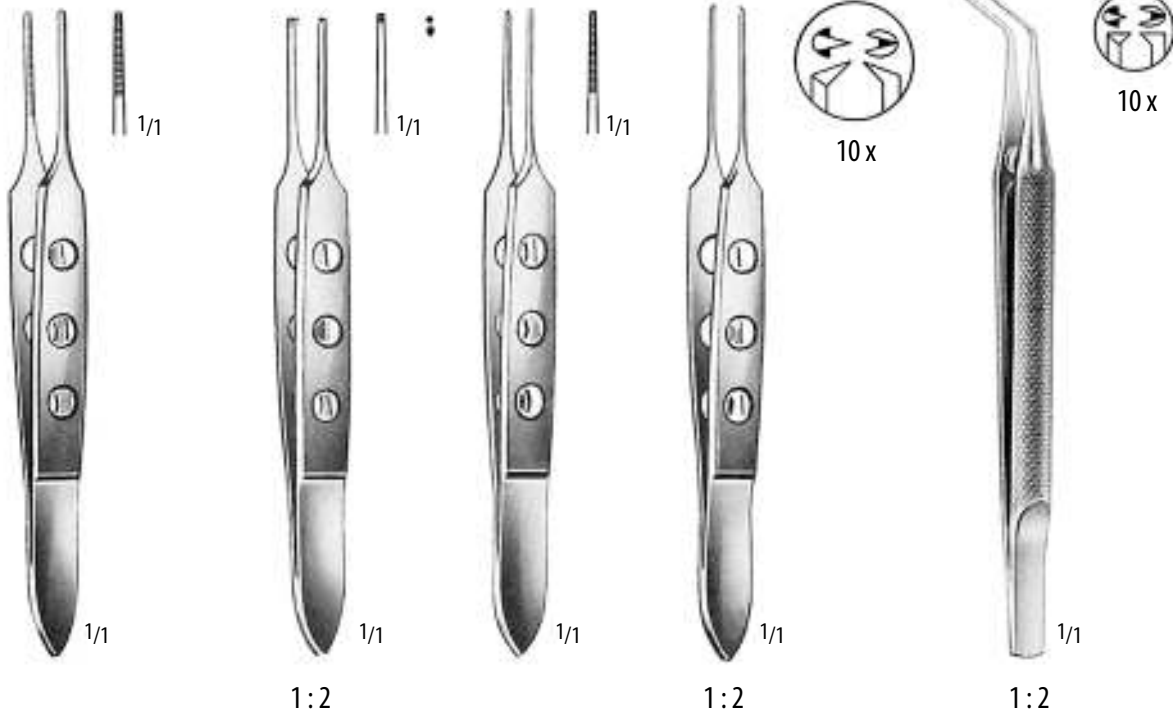

BISHOP - HARMAN

FO - 826 - 08 FO - 827 - 08
8,5 cm / 3 1/2" 8,5 cm / 3 1/2"

BISHOP - HARMAN

FO - 828 - 08 FO - 829 - 08
8,5 cm / 3 1/2" 8,5 cm / 3 1/2"

KIRBY

FO - 830 - 08
9,0 cm / 3 1/2"

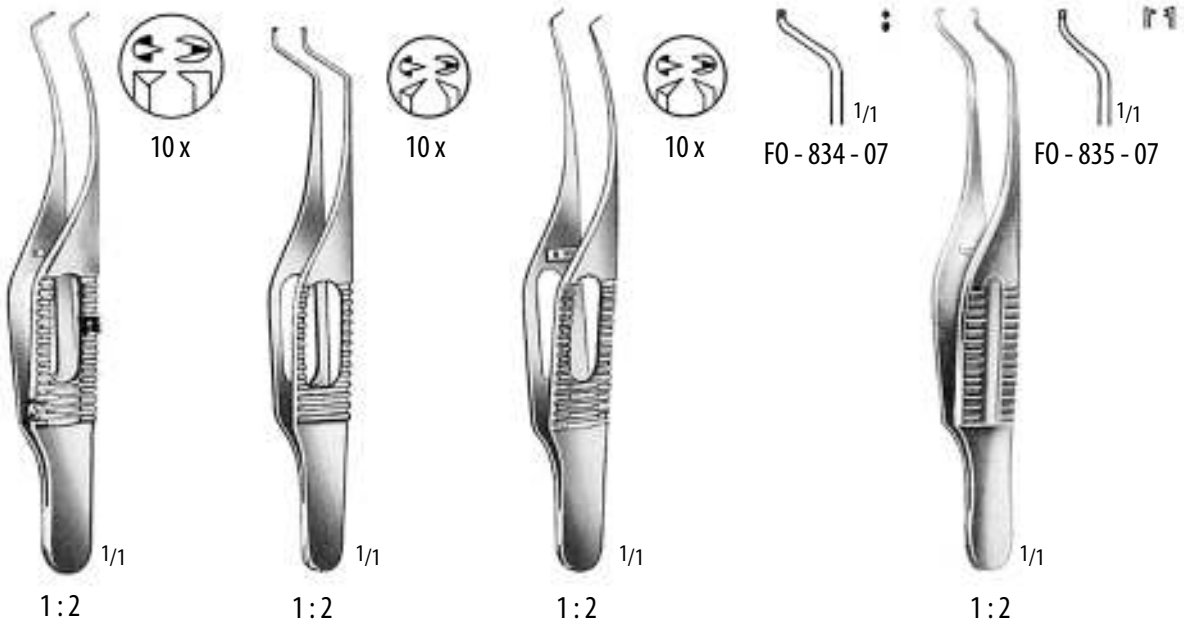

**BARRAQUER - KATZIN
(Colibri)**

FO - 831 - 07
7,0 cm / 2 3/4"

**TROUTMAN
(Corneal)**

FO - 832 - 07
7,5 cm / 3"

**BARRAQUER - KATZIN
(Colibri)**

FO - 833 - 07
7,0 cm / 2 3/4"

GILL - HESS

FO - 834 - 07 FO - 835 - 07
7,5 cm / 3"



GILL - FUCHS
FO - 836 - 07
7,5 cm / 3"



TERSON
FO - 837 - 09
9,0 cm / 3 1/2"



CASTROVIEJO
FO - 838 - 01
10,0 cm / 4"



CASTROVIEJO
FO - 838 - 02
10,0 cm / 4"

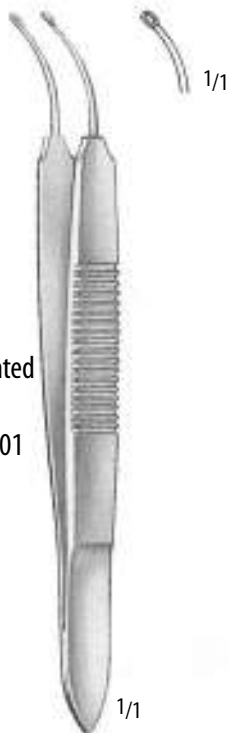

not calibrated
FO - 839 - 01

ARRUGA
10,0 cm / 4"

calibrated
FO - 839 - 02

not calibrated
FO - 840 - 01

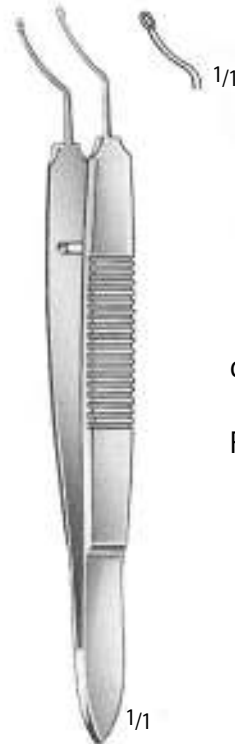

ARRUGA
10,0 cm / 4"

calibrated
FO - 840 - 02



BINKHORST
FO - 841 - 07
7,0 cm / 2 3/4"

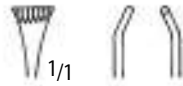

FO - 842 - 01

FO - 842 - 02

GRAEFE
11,0 cm / 4 1/2"

1/1

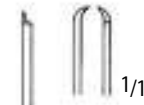

FO - 843 - 09



FO - 844 - 09

CASTROVIEJO 1 : 1
9,0 cm / 3 1/2"

1/1



ELSCHING 1 : 2
FO - 845 - 11
11,0 cm / 4 1/2"

1/1



1/1

ELSCHING 2 : 3
FO - 846 - 11
11,0 cm / 4 1/2"



1/1

ELSCHING 3 : 4
FO - 847 - 11
11,0 cm / 4 1/2"



1/1

LESTER
FO - 848 - 02 = 1 : 2
FO - 848 - 03 = 2 : 3
9,0 cm / 3 1/2"

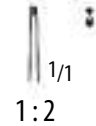

1/1

MOORFIELD
FO - 849 - 10
10,0 cm / 4"



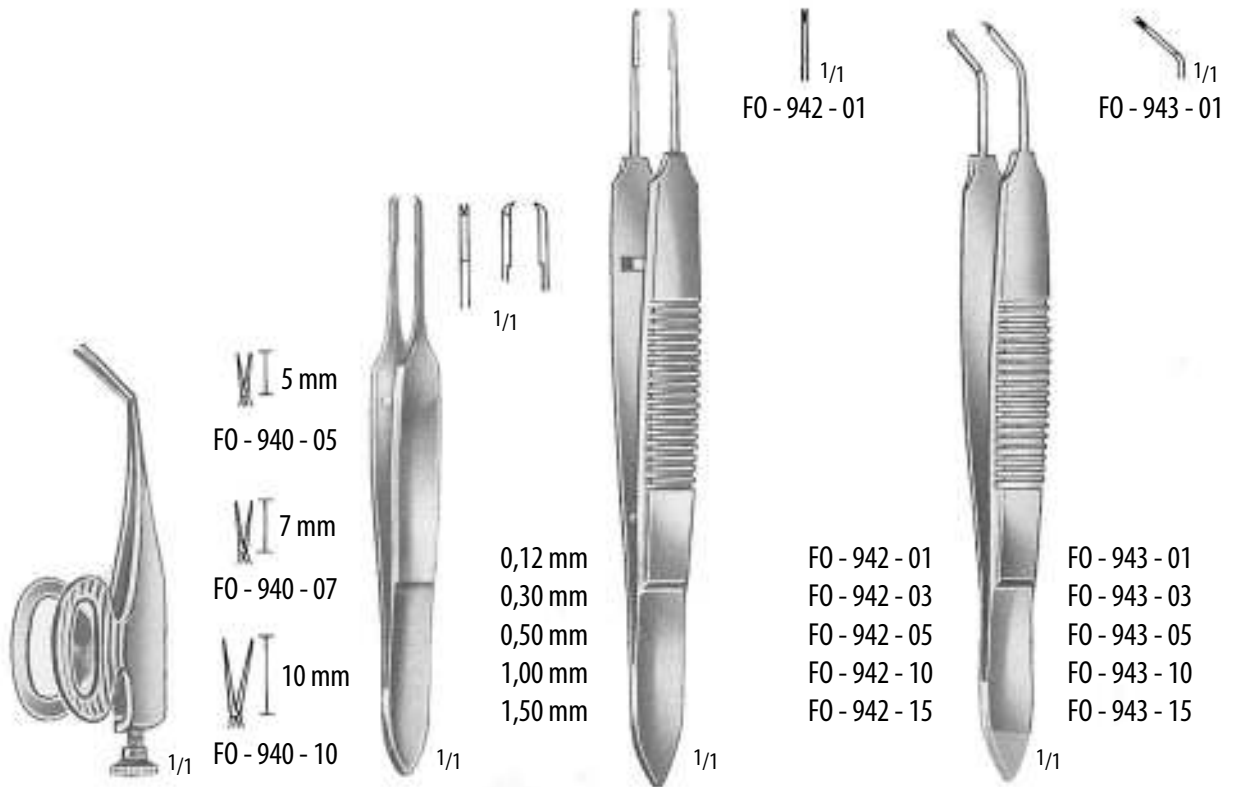

BARRAQUER
5,5 cm / 2 1/4"

ST. MARTIN 1 : 2
FO - 941 - 07
7,0 cm / 2 3/4"

CASTROVIEJO 1 : 2
10,0 cm / 4"

CASTROVIEJO 1 : 2
10,0 cm / 4"

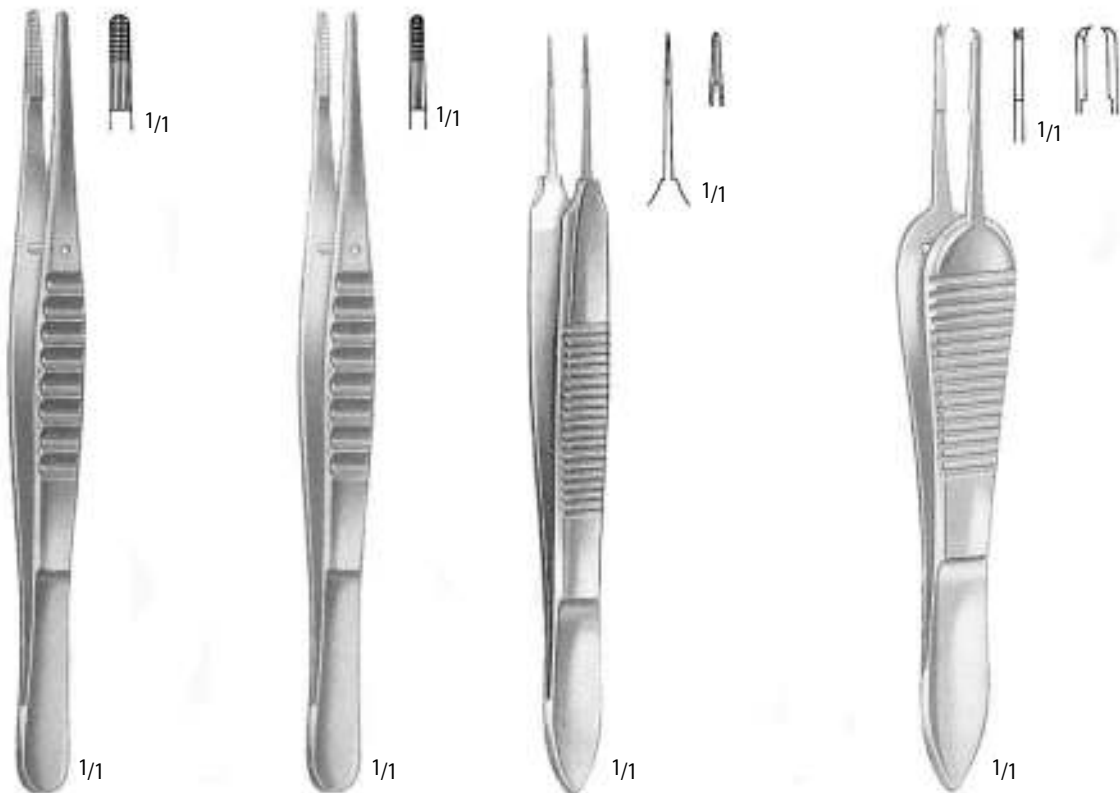

BONACCOLTO
FO - 944 - 01
10,0 cm / 4"

BONACCOLTO
FO - 944 - 02
10,0 cm / 4"

MOD. TÜBINGEN
FO - 945 - 10
10,0 cm / 4"

PAUFIGUE 1 : 2
FO - 946 - 10
10,0 cm / 4"

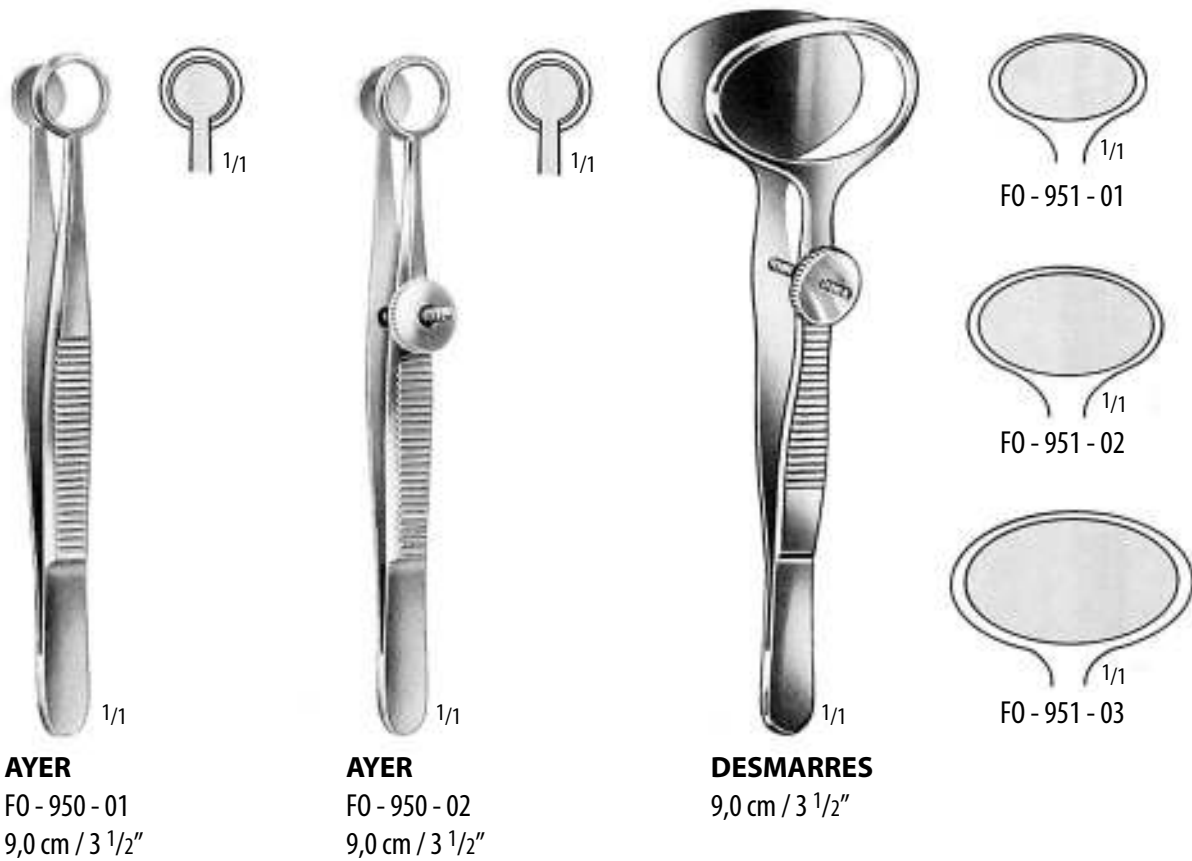
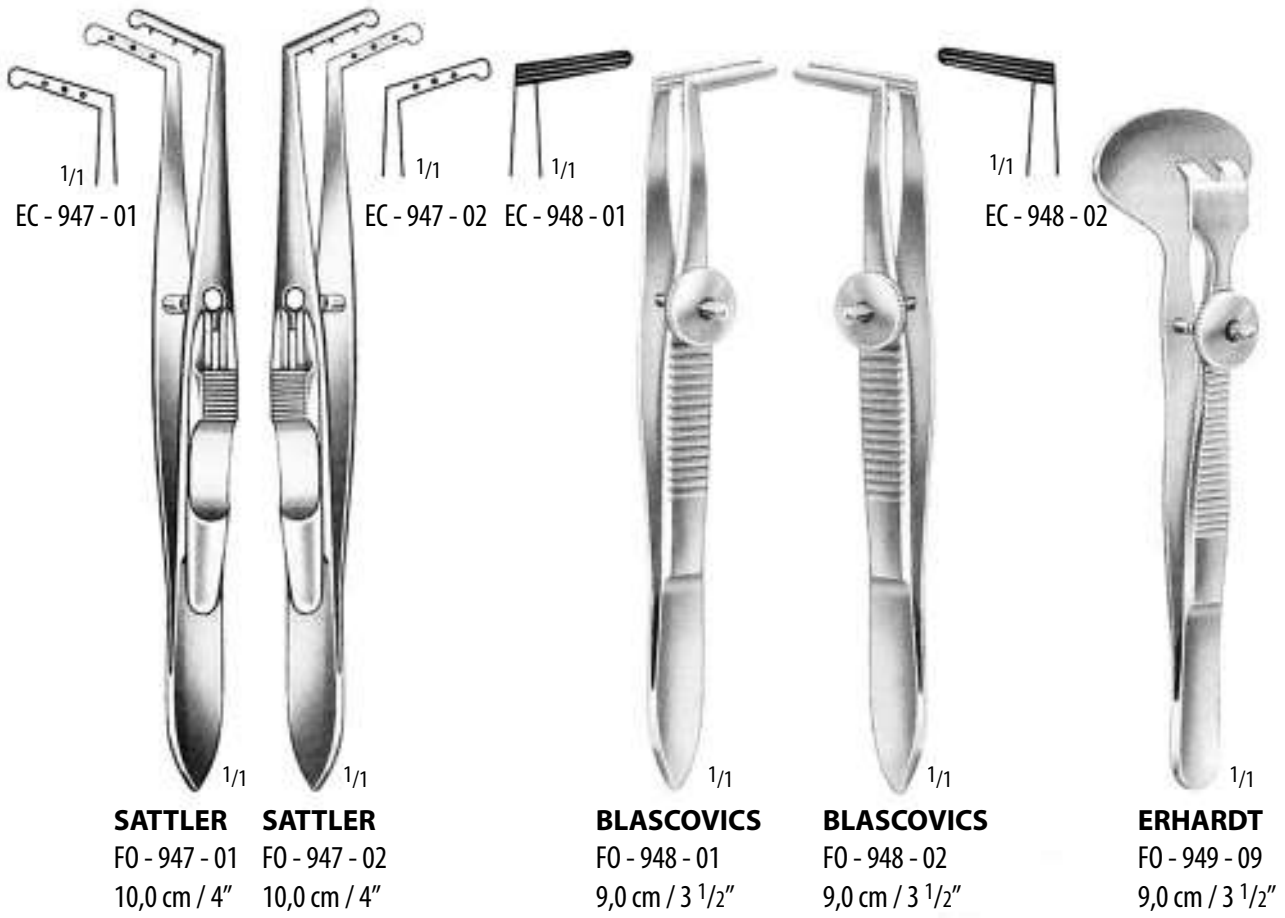

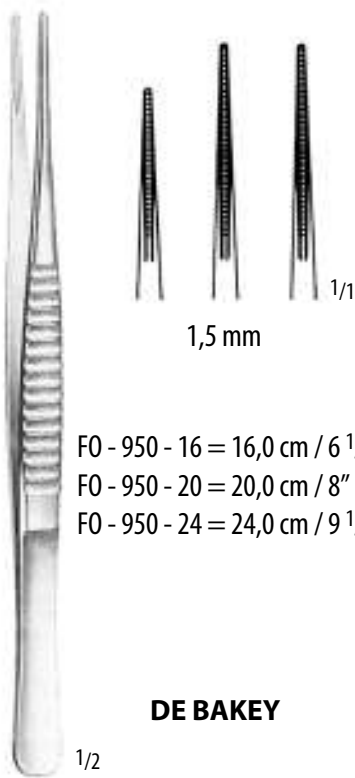

1,5 mm

FO - 950 - 16 = 16,0 cm / 6 1/4"
 FO - 950 - 20 = 20,0 cm / 8"
 FO - 950 - 24 = 24,0 cm / 9 1/4"

DE BAKAY

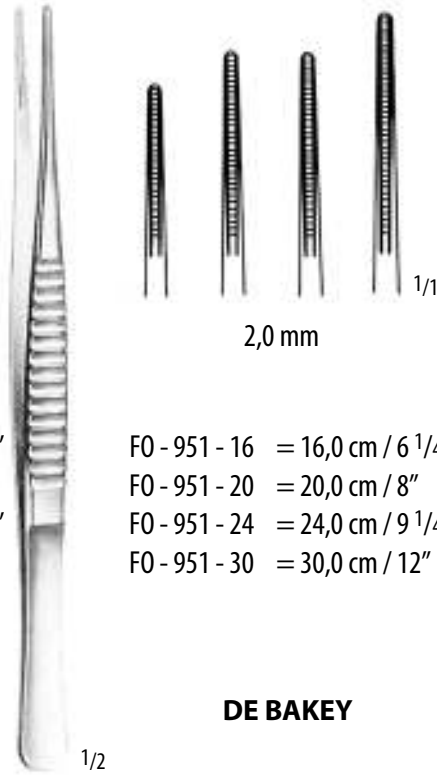

2,0 mm

FO - 951 - 16 = 16,0 cm / 6 1/4"
 FO - 951 - 20 = 20,0 cm / 8"
 FO - 951 - 24 = 24,0 cm / 9 1/4"
 FO - 951 - 30 = 30,0 cm / 12"

DE BAKAY

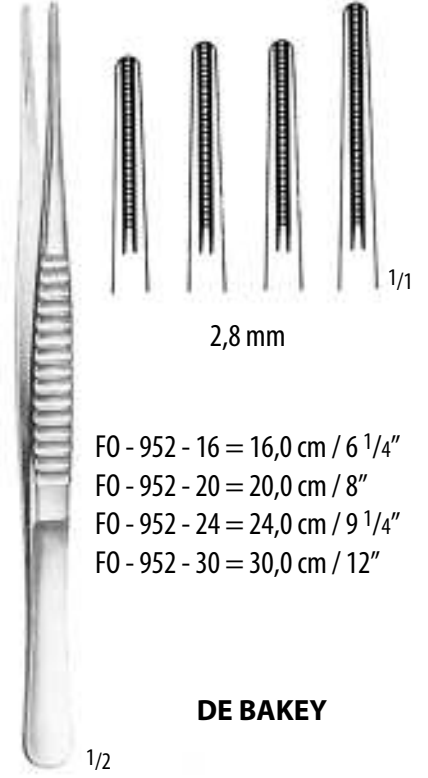

2,8 mm

FO - 952 - 16 = 16,0 cm / 6 1/4"
 FO - 952 - 20 = 20,0 cm / 8"
 FO - 952 - 24 = 24,0 cm / 9 1/4"
 FO - 952 - 30 = 30,0 cm / 12"

DE BAKAY

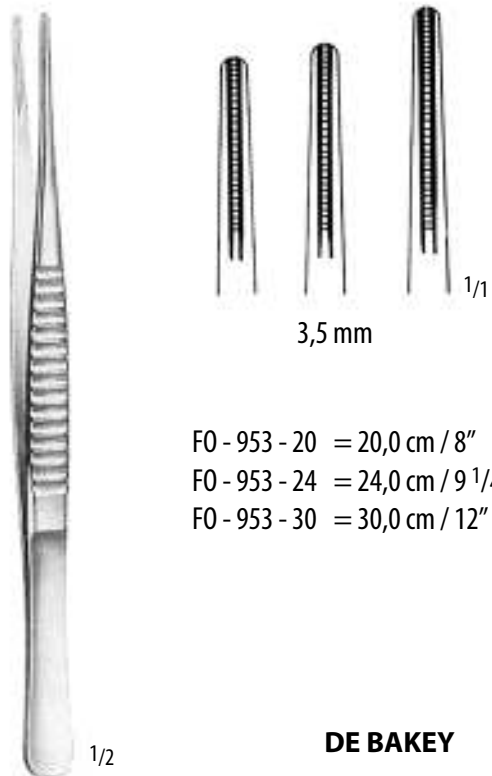

3,5 mm

FO - 953 - 20 = 20,0 cm / 8"
 FO - 953 - 24 = 24,0 cm / 9 1/4"
 FO - 953 - 30 = 30,0 cm / 12"

DE BAKAY

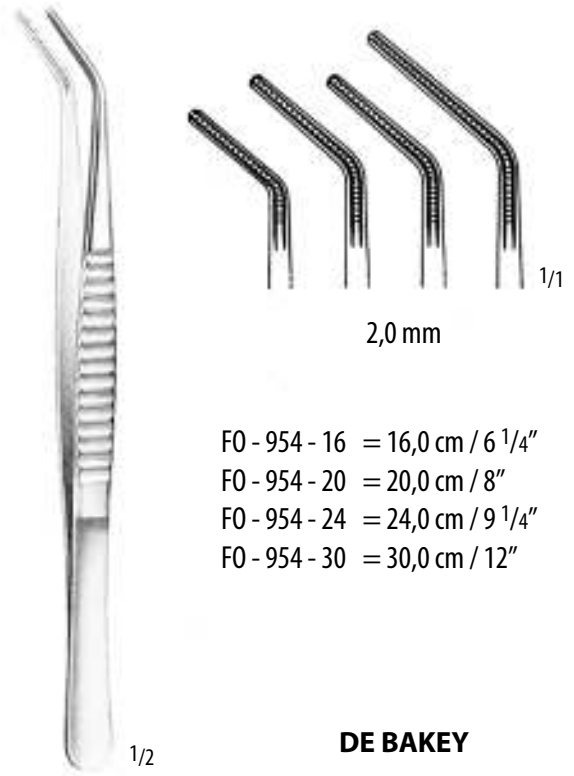

2,0 mm

FO - 954 - 16 = 16,0 cm / 6 1/4"
 FO - 954 - 20 = 20,0 cm / 8"
 FO - 954 - 24 = 24,0 cm / 9 1/4"
 FO - 954 - 30 = 30,0 cm / 12"

DE BAKAY



1/2

POTTS - SMITH



1/1

FO - 400 - 15
15,0 cm / 6"



1/1

FO - 400 - 18
18,0 cm / 7"



1/1

FO - 400 - 20
20,0 cm / 8"



1/1

FO - 400 - 23
23,0 cm / 9"



1/1

FO - 400 - 25
25,0 cm / 10"



1/2

OEHLER 1 : 2



1/1

FO - 401 - 14
14,0 cm / 5 1/2"



1/1

FO - 401 - 16
16,0 cm / 6 1/4"



1/1

FO - 401 - 18
18,0 cm / 7"



1/1



1/1

FO - 401 - 20
20,0 cm / 8"



1/1

FO - 401 - 25
25,0 cm / 10"



1/1

FO - 401 - 30
30,0 cm / 12"



1/2

SEMKEN

FO - 402 - 12 12,5 cm / 5"
FO - 402 - 15 15,5 cm / 6"



1/1

FO - 402 - 12



1/2

GILLIES 1 : 2

FO - 403 - 15
15,0 cm / 6"



1/1



1/2

JEWELER

FO - 404 - 15
15,0 cm / 6"



1/1

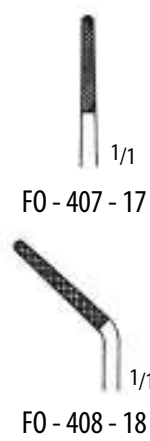
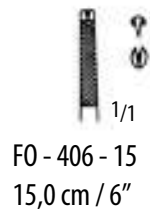
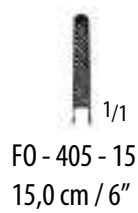
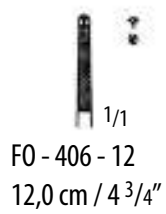
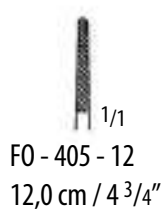



1/2

DE BAKKEY

16,0 cm / 6 1/4"
20,0 cm / 8"
24,0 cm / 9 1/4"



3/1

1,5 mm

FO - 410 - 16

FO - 410 - 20

FO - 410 - 24

2,0 mm

FO - 411 - 16

FO - 411 - 20

FO - 411 - 24



1/2

BONNEY 1 : 2

FO - 412 - 18
18,0 cm / 7"



1/1



1/2

WANGENSTEEN



1/1

FO - 413 - 15
15,0 cm / 6"



1/1

FO - 413 - 23
23,0 cm / 9"

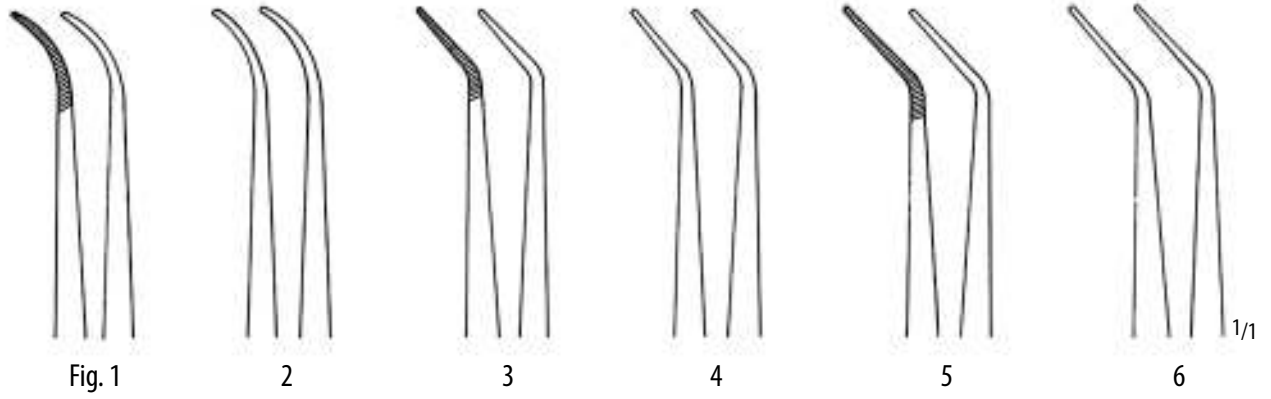

Fig. 1

2

3

4

5

6

1/1

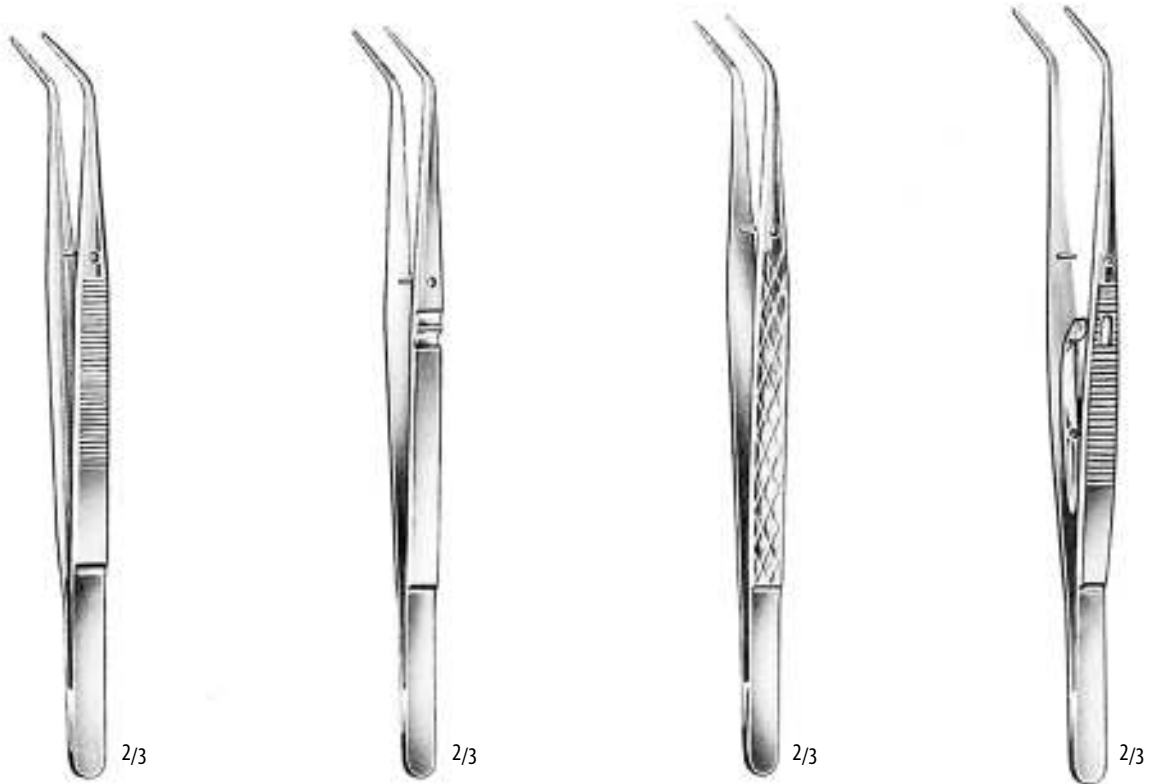

2/3

2/3

2/3

2/3

LONDON COLLEGE

15,0 cm / 6"

- Fig. 1 FO - 415 - 01
- Fig. 2 FO - 415 - 02
- Fig. 3 FO - 415 - 03
- Fig. 4 FO - 415 - 04
- Fig. 5 FO - 415 - 05
- Fig. 6 FO - 415 - 06

LONDON COLLEGE

15,0 cm / 6"

- FO - 416 - 01
- FO - 416 - 02
- FO - 416 - 03
- FO - 416 - 04
- FO - 416 - 05
- FO - 416 - 06

LONDON COLLEGE

15,0 cm / 6"

- FO - 417 - 01
- FO - 417 - 02
- FO - 417 - 03
- FO - 417 - 04
- FO - 417 - 05
- FO - 417 - 06

LONDON COLLEGE

15,0 cm / 6"

- FO - 418 - 01
- FO - 418 - 02
- FO - 418 - 03
- FO - 418 - 04
- FO - 418 - 05
- FO - 418 - 06

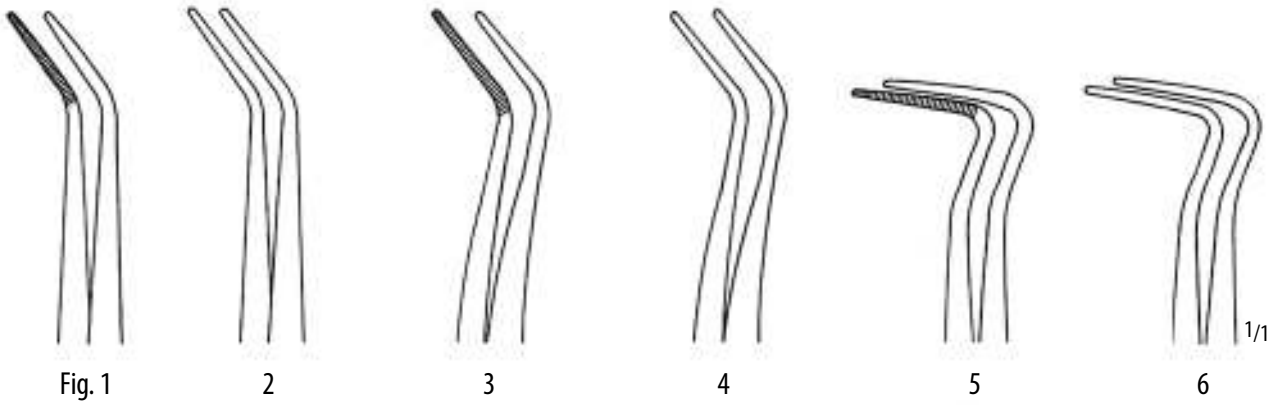

Fig. 1

2

3

4

5

6

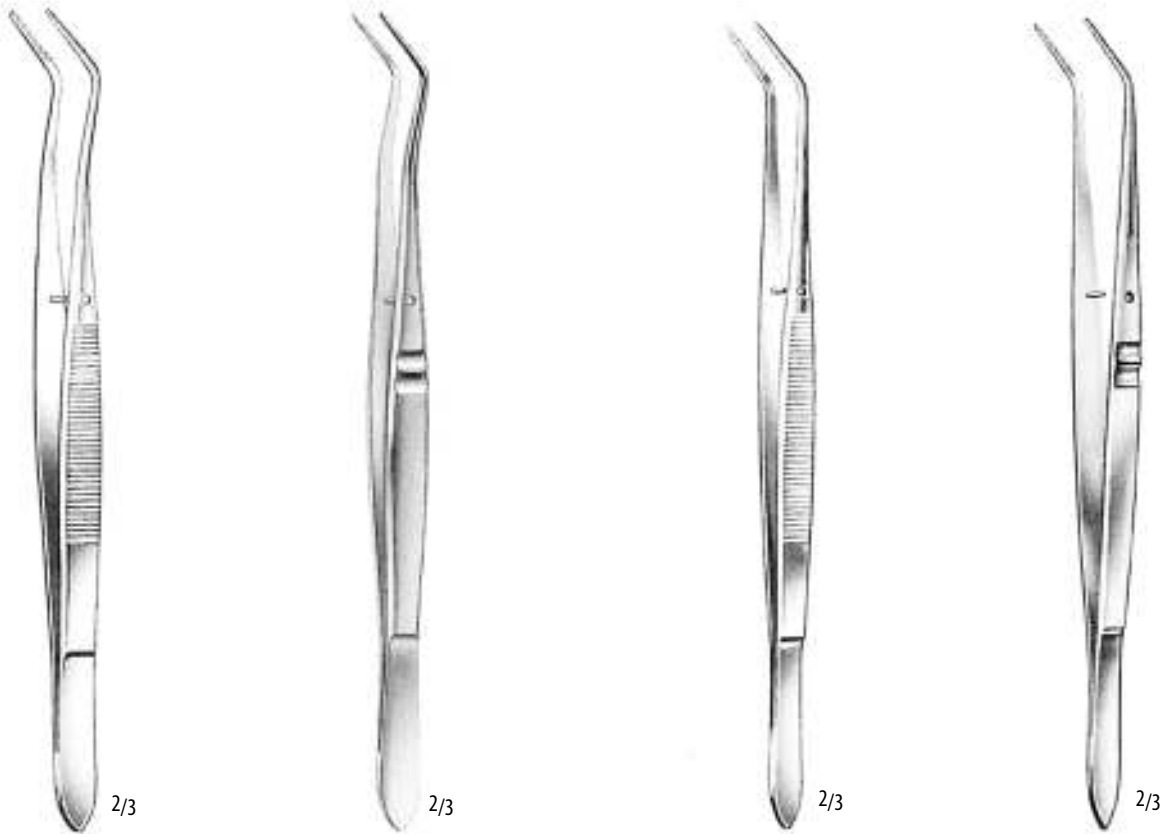

MERIAM

16,0 cm / 6 1/4"

- Fig. 1 FO - 419 - 01
- Fig. 2 FO - 419 - 02
- Fig. 3 FO - 419 - 03
- Fig. 4 FO - 419 - 04
- Fig. 5 FO - 419 - 05
- Fig. 6 FO - 419 - 06

MERIAM

16,0 cm / 6 1/4"

- FO - 420 - 01
- FO - 420 - 02
- FO - 420 - 03
- FO - 420 - 04
- FO - 420 - 05
- FO - 420 - 06

FLAGG

16,0 cm / 6 1/4"

- FO - 421 - 01
- FO - 421 - 02
- FO - 421 - 03
- FO - 421 - 04
- FO - 421 - 05
- FO - 421 - 06

FLAGG

16,0 cm / 6 1/4"

- FO - 422 - 01
- FO - 422 - 02
- FO - 422 - 03
- FO - 422 - 04
- FO - 422 - 05
- FO - 422 - 06



LANDGRAF
15,0 cm / 6"



Fig. 1
FO - 423 - 01



Fig. 2
FO - 423 - 02

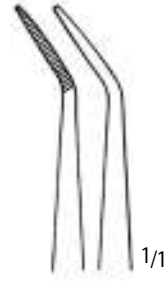

Fig. 3
FO - 423 - 03

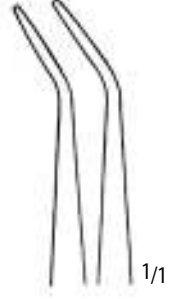

Fig. 4
FO - 423 - 04



PERRY
12,5 cm / 5"



Fig. 1
FO - 424 - 01



Fig. 2
FO - 424 - 02



15,0 cm / 6"

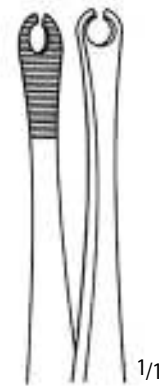

FO - 425 - 01

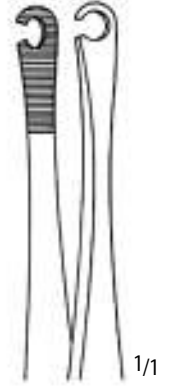

FO - 425 - 02

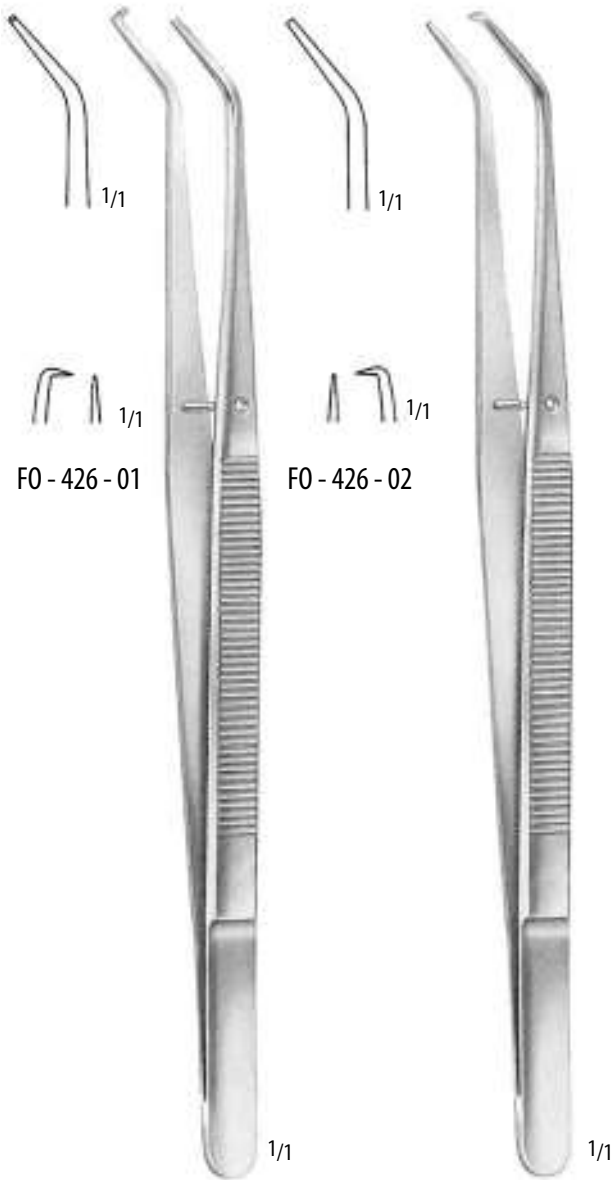

FO - 426 - 01

FO - 426 - 02

CRANE - KAPLAN

FO - 426 - 01

FO - 426 - 02

15,0 cm / 6"

15,0 cm / 6"

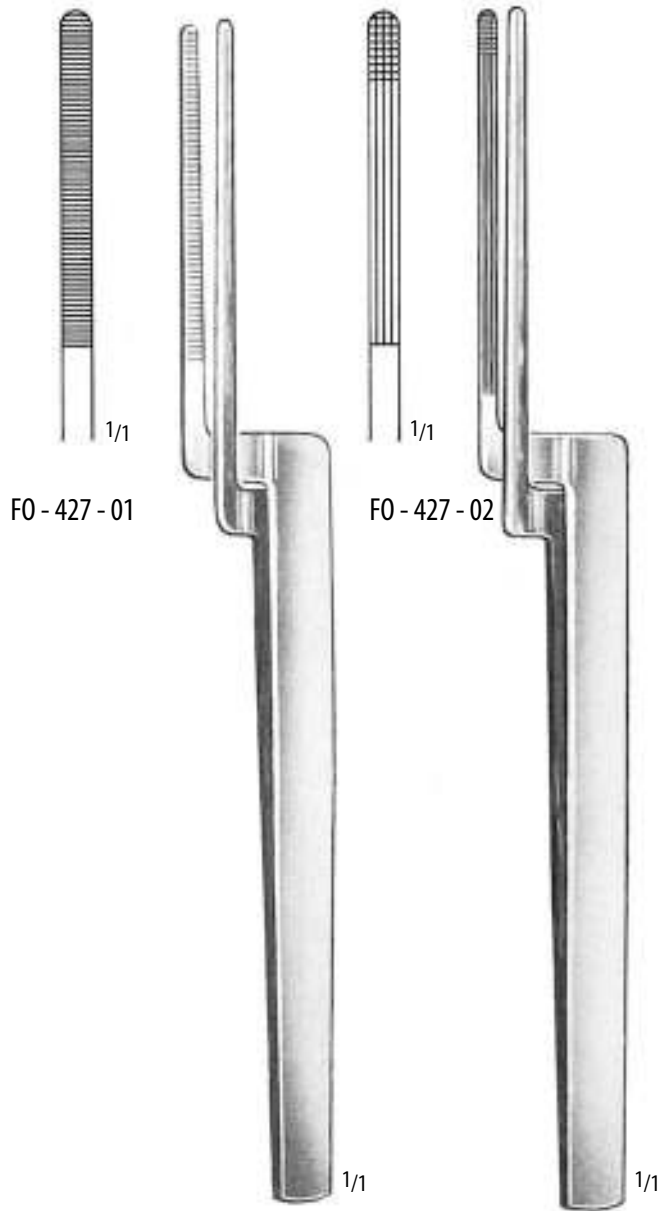

FO - 427 - 01

FO - 427 - 02

MILLER

15,0 cm / 6"

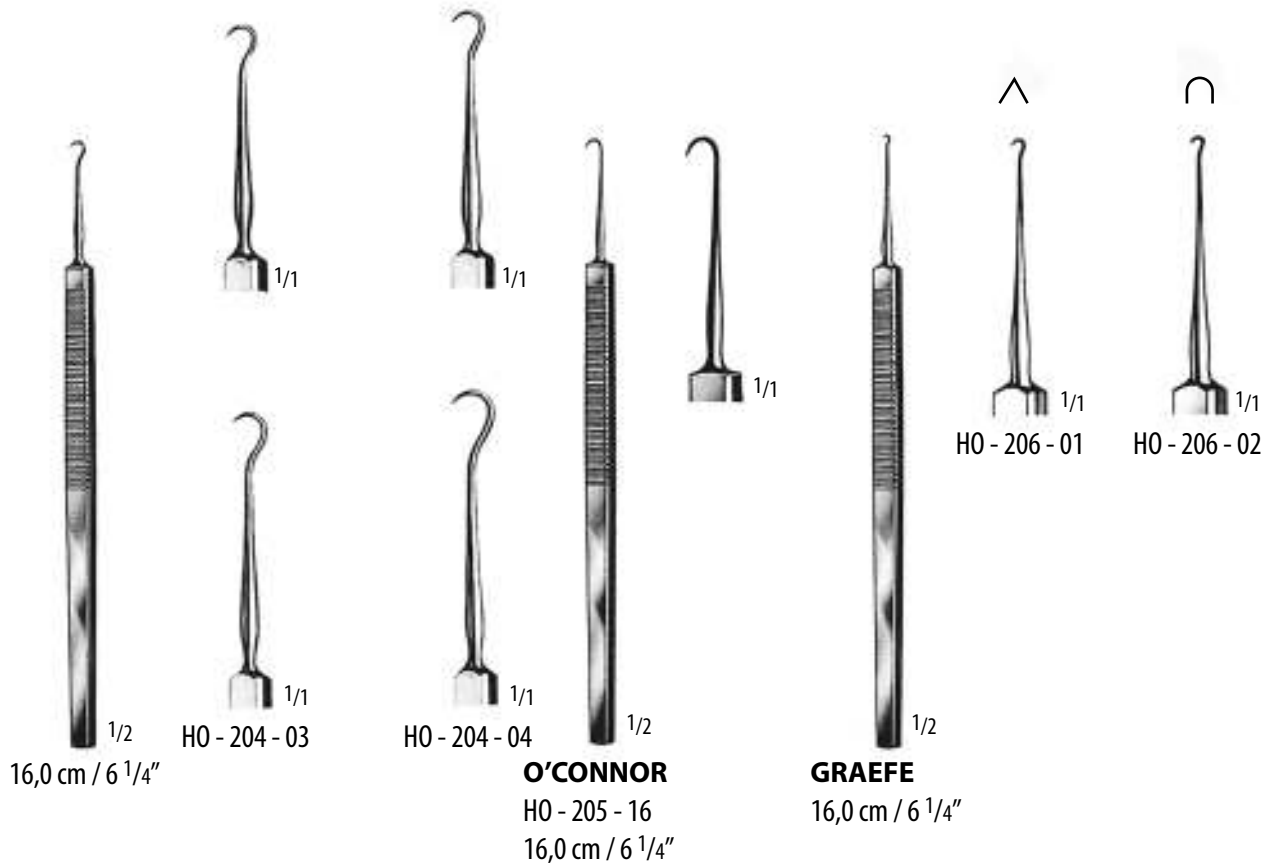
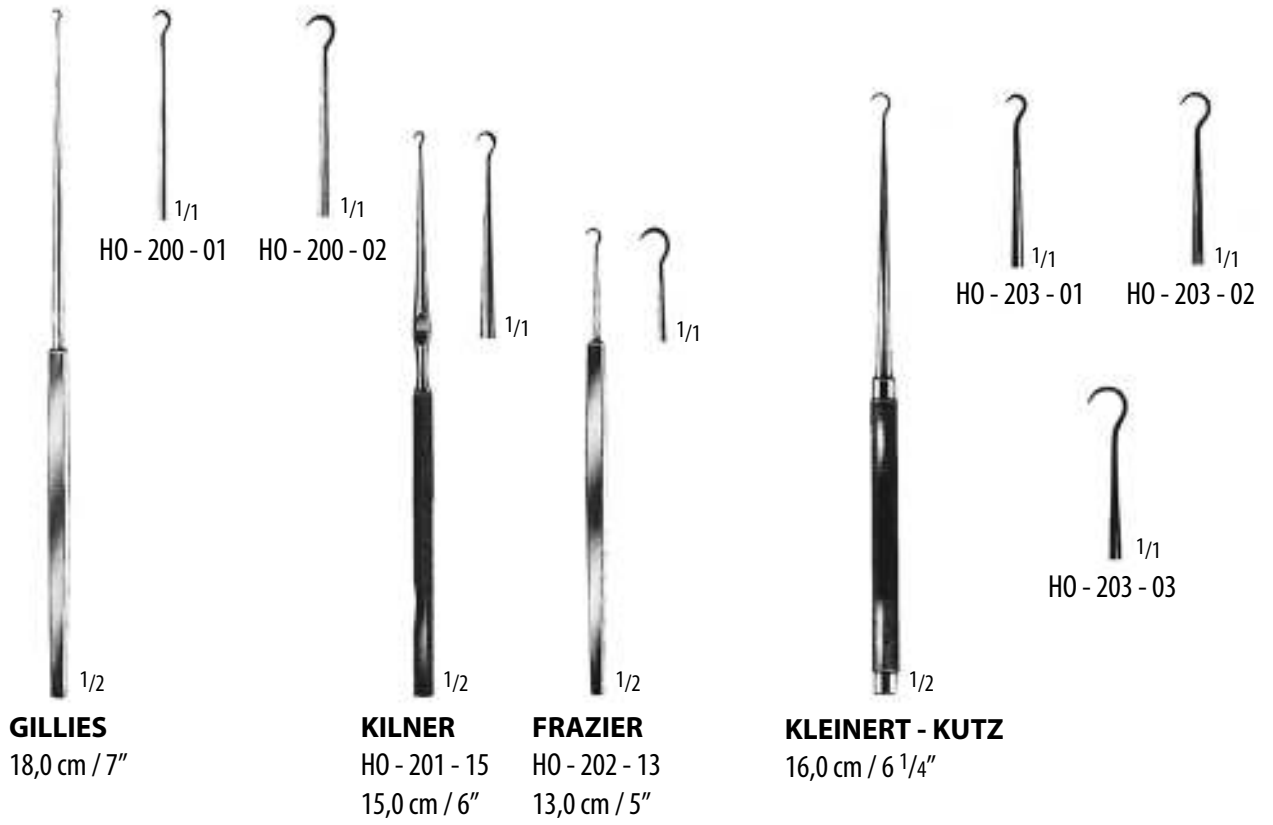

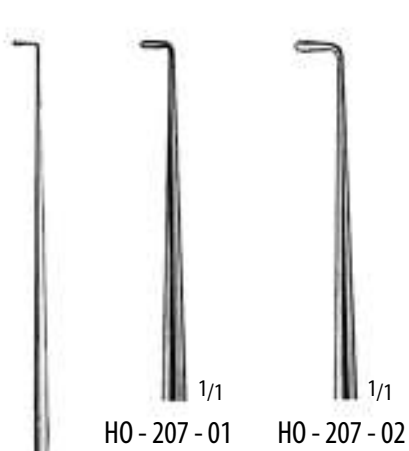

HO - 207 - 01
1/1

HO - 207 - 02
1/1

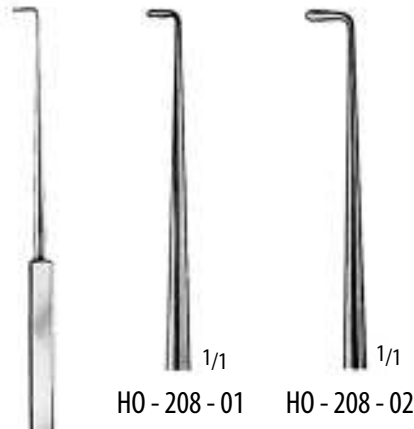

HO - 208 - 01
1/1

HO - 208 - 02
1/1

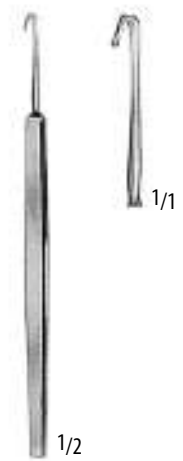

MOLDESTAD
HO - 209 - 13
13,0 cm / 5"



CUSHING
28,0 cm / 11"

CUSHING
19,0 cm / 7 1/4"

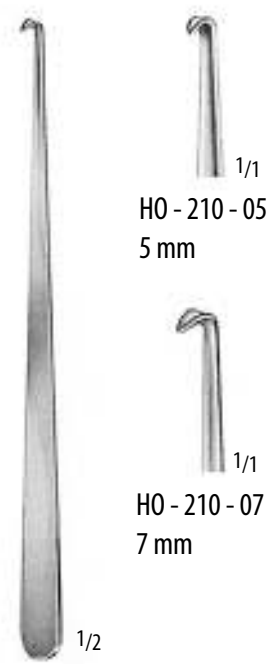

HO - 210 - 05
5 mm
1/1

HO - 210 - 07
7 mm
1/1

17,0 cm / 6 3/4"
1/2

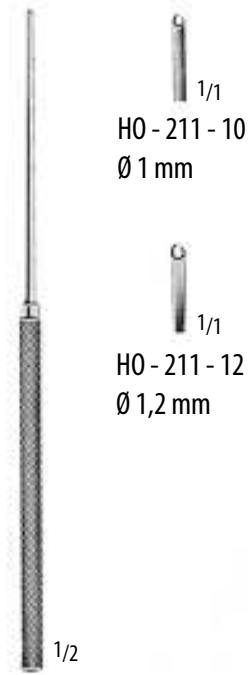







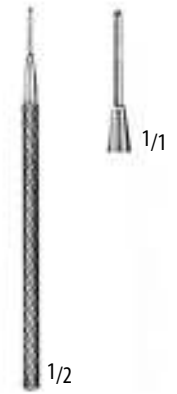

HO - 211 - 10
Ø 1 mm
1/1



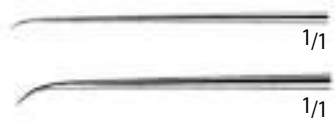







HO - 211 - 12
Ø 1,2 mm
1/1











18,5 cm / 7 1/4"
1/2



HO - 212 - 11
11,0 cm / 4 1/4"
1/2

<p>HO - 300 - 16 Needle (perforator), straight, sharp point 160 mm, 6 1/4"</p>	 <p>1/1</p>	<p>1/1</p>
<p>HO - 301 - 16 Needle slightly curved, sharp point 160 mm, 6 1/4"</p>	 <p>1/1 1/1</p>	
<p>HO - 302 - 16 Needle, strongly curved, sharp point 160 mm, 6 1/4"</p>	 <p>1/1 1/1</p>	
<p>ROSEN HO - 303 - 16 Hook, blackened finish 160 mm, 6 1/4"</p>	 <p>1/1 1/1</p>	
<p>SHAMBAUGH HO - 304 - 04 0,4 mm HO - 304 - 08 0,8 mm HO - 304 - 06 0,6 mm HO - 304 - 10 1,0 mm Fenestra hook, 45° angled 160 mm, 6 1/4"</p>	 <p>1/1 1/1</p>	
<p>SHAMBAUGH HO - 310 - 04 0,4 mm HO - 310 - 08 0,8 mm HO - 310 - 06 0,6 mm HO - 310 - 10 1,0 mm Fenestra hook, 90° angled 160 mm, 6 1/4"</p>	 <p>1/1 1/1</p>	
<p>HO - 315 - 16 Footplate hook, retrograde curved, for adherences, mesos, stapes and window 160 mm, 6 1/4"</p>	 <p>1/1 1/1</p>	
<p>PLESTER HO - 316 - 16 2,0 mm Scraper, 45° angled, for roughening of tympanum surface 160 mm, 6 1/4"</p>	 <p>1/1 1/1</p>	

		1/1
HO - 400 - 16 Hook reverse cutting 160 mm, 6 1/4"		1/1
PLESTER HO - 401 - 16 0,4 mm Footplate hook, 45° angled, oval-blunt 160 mm, 6 1/4"		1/1
HO - 402 - 16 Hook straight, shaft, slightly angled at tip 160 mm, 6 1/4"		1/1
HOUGH HO - 403 - 16 Footplate hook, 90° angled 160 mm, 6 1/4"		1/1
BEALE HO - 404 - 16 Hook straight, angled upwards for removal of footplate 160 mm, 6 1/4"		1/1
PLESTER HO - 405 - 16 Antrum hook, 90° angled, cylindric 160 mm, 6 1/4"		1/1
PLESTER HO - 406 - 16 Antrum hook, 45° angled, cylindric 160 mm, 6 1/4"		1/1
PLESTER HO - 407 - 16 Wire guide and applicator for prosthesis 160 mm, 6 1/4"		1/1
PLESTER HO - 408 - 16 Stapes mobilisier 160 mm, 6 1/2"		1/1

		1/1
HO - 450 - 16 Footplate knife, straight 160 mm, 6 1/4"		1/1
PLESTER HO - 451 - 16 Sickle knife, slightly curved 160 mm, 6 1/4"		1/1
THORBURN HO - 452 - 16 Sickle knife, curved tip 160 mm, 6 1/4"		1/1
BEALES HO - 453 - 16 Tendon knife 160 mm, 6 1/4"		1/1
HO - 454 - 16 2,4 mm x 3 mm Flap knife, round cutting, blade in line with shaft 160 mm, 6 1/4"	 2,4 mm 3,0 mm	1/1
PLESTER HO - 455 - 16 Flap knife, round cutting, blade in line with shaft 160 mm, 6 1/4"		1/1
ROSEN HO - 456 - 16 Knife and elevator, spear pointed blade 160 mm, 6 1/4"		1/1
HO - 457 - 16 Round cutting knife, for incision of soft tissue, 45° angled, slender 160 mm, 6 1/4"		1/1
HO - 458 - 16 Round cutting knife, 45° angled 160 mm, 6 1/4"		1/1



1/1

HO - 460 - 16 Ø 2,6 mm
Round cutting knife, angled
 160 mm, 6 1/4"

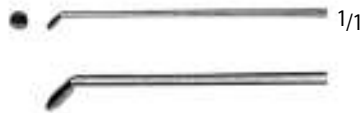

HO - 461 - 16 Ø 1,5 mm
Round cutting knife, angled
 160 mm, 6 1/4"



HO - 462 - 16 3 mm
Round cutting knife, for incising skin of external auditory meatus, angled
 160 mm, 6 1/4"



SCHUKNECHT
 HO - 463 - 16
Roller knife, for incising skin of the bony external auditory meatus, blade at right angle to shaft
 160 mm, 6 1/4"



SCHUKNECHT
 HO - 464 - 16
Roller knife, same as above, but blade in line with shaft
 160 mm, 6 1/4"





HO - 470 - 16 2 mm broad
Graft holder and elevator, for lifting drum forward
 160 mm, 6 1/4"

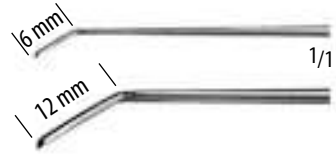

HO - 471 - 16 1 mm broad
Elevator, for lifting drum forward, slightly angled
 160 mm, 6 1/4"



HO - 472 - 16 1,8 mm broad
Seperator, round edge, slightly curved, for dissection of soft tissue
 160 mm, 6 1/4"



HO - 473 - 16
Excavator, small, double curve right
 160 mm, 6 1/4"



HO - 474 - 16
Excavator, small, double curve right
 160 mm, 6 1/4"



HO - 475 - 16
Measuring rod (caliper) marker pins at 3,5 - 4 - 4,5 mm
 160 mm, 6 1/4"



HO - 480 - 00
Preparation tray with mm scale, stainless steel
 160 mm, 6 1/4"





HO - 470 - 16 2 mm broad
Graft holder and elevator, for lifting drum forward
160 mm, 6 1/4"



SHEA
HO - 501 - 16 Ø 1,5 + 2,5 mm
Curette for tympanoplasty and myringoplasty, oval cups
160 mm, 6 1/4"



HOUSE
HO - 502 - 15 Ø 1,0 + 1,2 mm
HO - 503 - 15 Ø 1,5 + 1,8 mm
Curette, double ended, for stapedectomy, oval cups
150 mm, 6"



HOUSE
HO - 504 - 15 Ø 1,0 + 1,2 mm
HO - 505 - 15 Ø 1,5 + 1,8 mm
Curette, double ended, for stapedectomy, oval cups strongly angled
150 mm, 6"



HO - 506 - 17
Curette, double ended, for stapedectomy, angled cups, pointed, large
170 mm, 6 3/4"



ALLIS 4 : 5
HM - 400 - 15
15,0 cm / 6"



ALLIS 5 : 6
15,0 cm / 6" HM - 401 - 15
19,0 cm / 7 1/2" HM - 401 - 19
25,0 cm / 10" HM - 401 - 25



BABCOCK



HM - 410 - 16
16,0 cm / 6 1/4"



HM - 410 - 18
18,0 cm / 7"



HM - 410 - 20
20,0 cm / 8"



HM - 410 - 24
24,0 cm / 9 1/2"

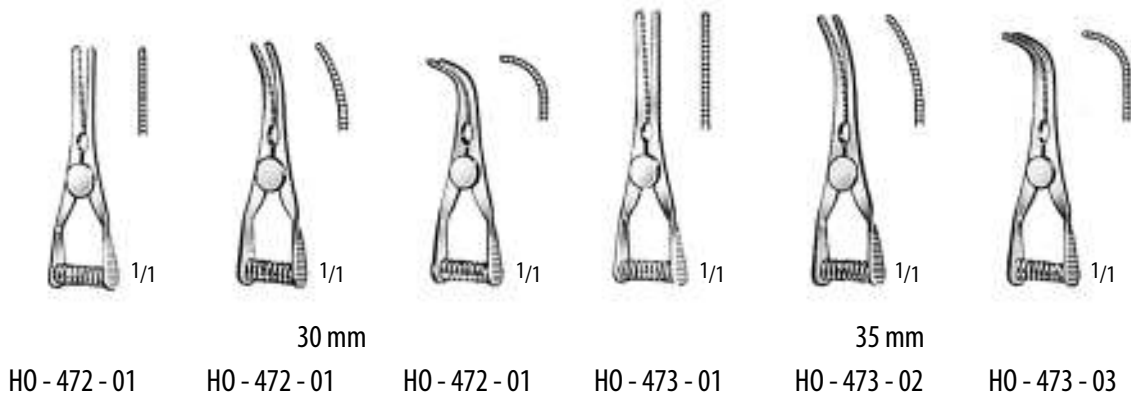
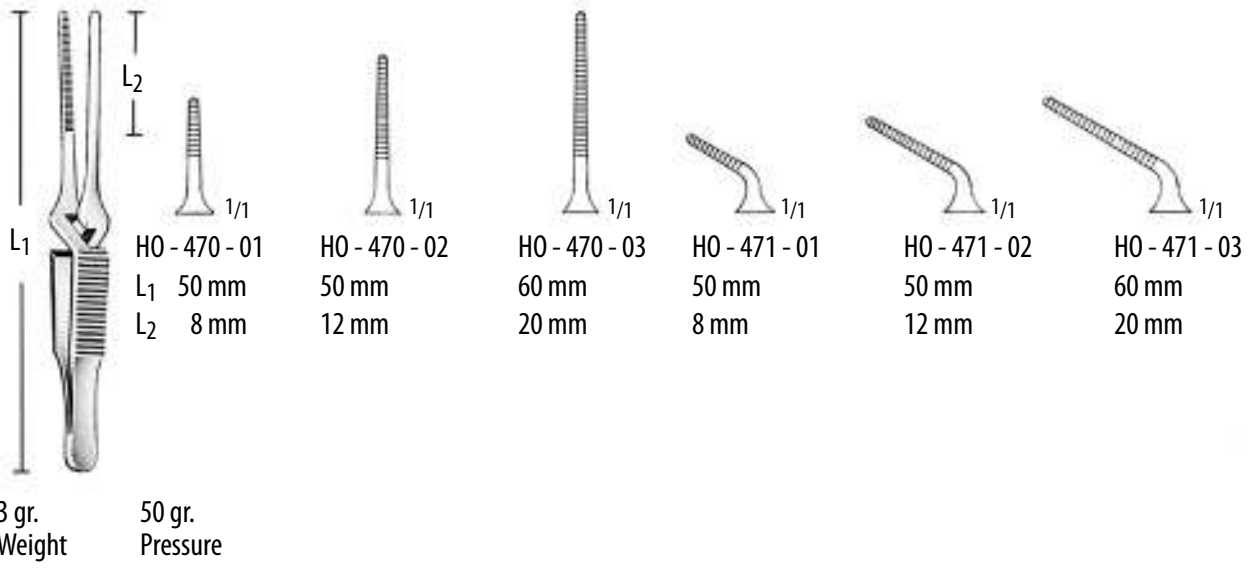

**VENA
ARTERIA**

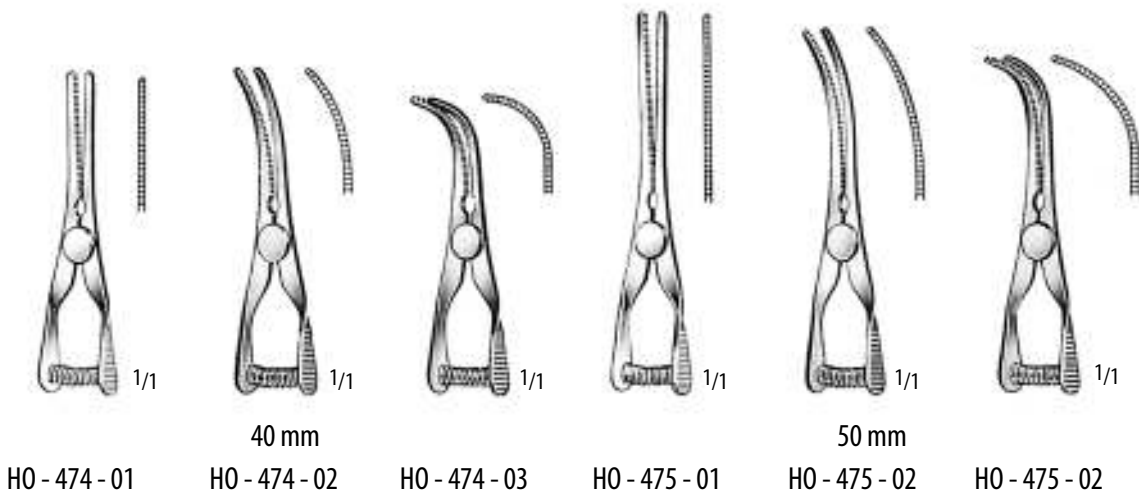

**VENA
ARTERIA**



1/1

DIEFFENBACH



1/1

HM-476-03
3,5 cm / 1 1/2"



1/1

HM-476-05
5,0 cm / 2"



1/1

HM-476-06
6,0 cm / 2 1/2"



1/1

HM-477-03
3,5 cm / 1 1/2"



1/1

HM-477-05
5,0 cm / 2"



1/1

HM-477-06
6,0 cm / 2 1/2"



1/2

JOHNS - HOPKINS **JOHNS - HOPKINS**
24,5 cm / 9 3/4"

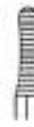

1/1

HM-480-04
4,0 cm / 1 1/2"



1/1

HM-480-05
5,0 cm / 2"



1/1

HM-480-06
6,5 cm / 2 1/2"



1/1

HM-480-07
7,5 cm / 3"



1/1

HM-480-09
9,0 cm / 3 1/2"



1/1

HM-481-04
4,0 cm / 1 1/2"



1/1

HM-481-05
5,0 cm / 2"



1/1

HM-481-06
6,5 cm / 2 1/2"



1/1

HM-481-07
7,5 cm / 3"



1/1

HM-481-09
9,0 cm / 3 1/2"



CHAPUT
HM - 482 - 13
13,0 cm / 5"



TUFFIER
HM - 483 - 13
13,0 cm / 5"

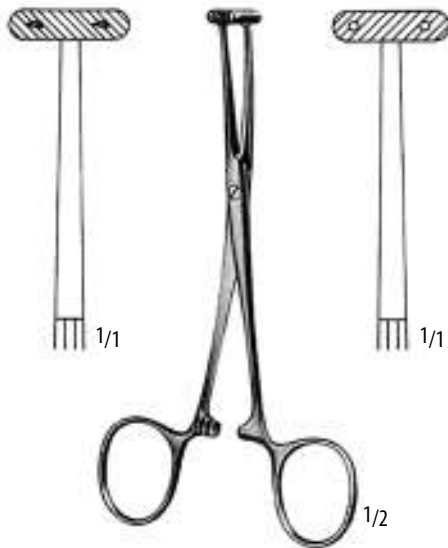

MARTEL
HM - 484 - 14
14,0 cm / 5 1/2"

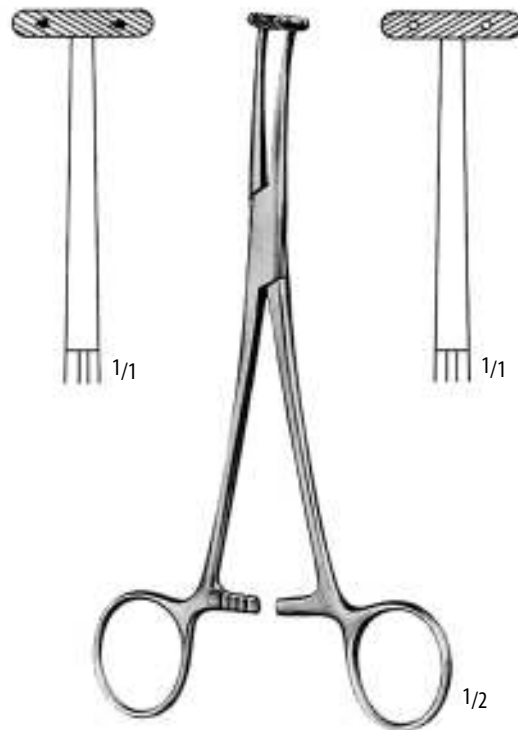

WILLET - MARTEL
HM - 484 - 19
19,0 cm / 7 1/2"

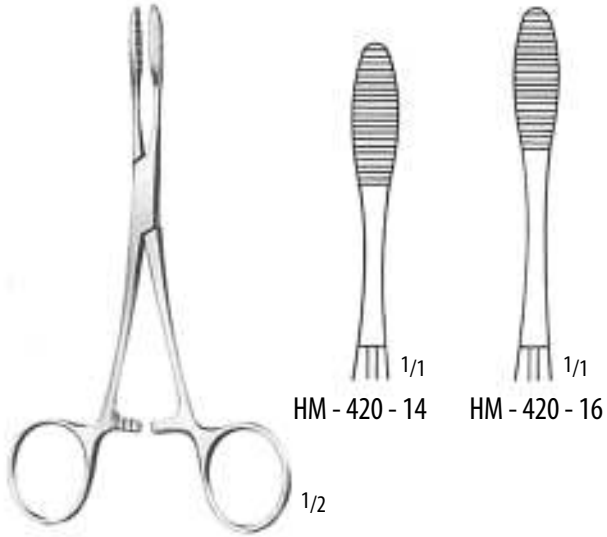

PEAN

14,0 cm / 5 1/2"

16,0 cm / 6 1/4"

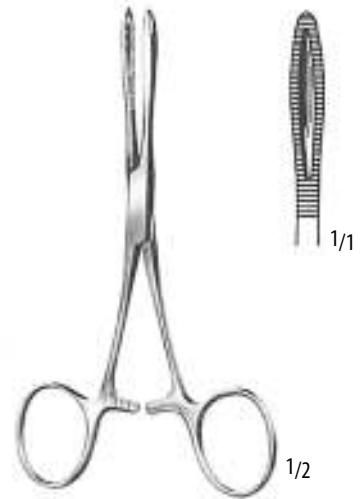

KROENLEIN

HM - 421 - 13

13,0 cm / 5"



PENNINGTON

15,5 cm / 6" HM - 422 - 15

20,0 cm / 8" HM - 422 - 20

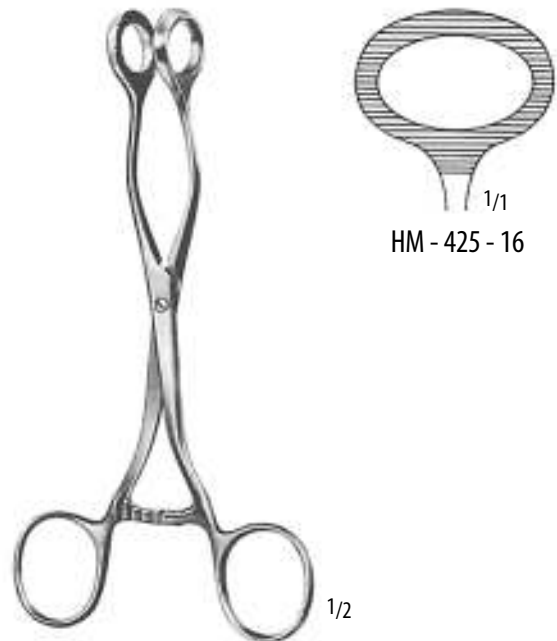







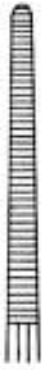

COLLIN

16,0 cm / 6 1/4"



SPENCER - WELLS

	 1/1	 1/1	 1/1	 1/1	 1/1
	HM - 430 - 13 13,0 cm / 5"	HM - 430 - 14 14,0 cm / 5 1/2"	HM - 430 - 15 15,5 cm / 6"	HM - 430 - 18 18,0 cm / 7"	HM - 430 - 20 20,0 cm / 8"
	 1/2	 1/1	 1/1	 1/1	 1/1
	HM - 431 - 13 13,0 cm / 5"	HM - 431 - 14 14,0 cm / 5 1/2"	HM - 431 - 15 15,5 cm / 6"	HM - 431 - 18 18,0 cm / 7"	HM - 431 - 20 20,0 cm / 8"



HARTMANN
HM - 432 - 10
10,0 cm / 4"



HARTMANN
HM - 433 - 10
10,0 cm / 4"



CARREL
HM - 434 - 08
8,5 cm / 3 1/2"

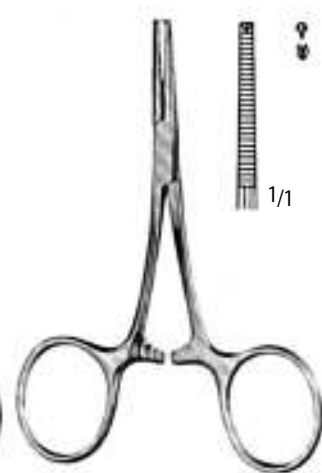

TERRIER 1 : 2
HM - 435 - 08
8,5 cm / 3 1/2"

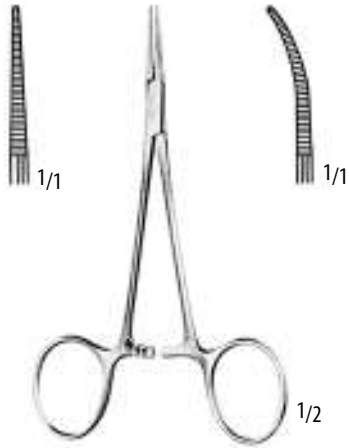

MICRO - MOSQUITO

HM - 436 - 10 HM - 437 - 10
HM - 436 - 12 HM - 437 - 12

10,0 cm / 4"
12,0 cm / 4³/₄"

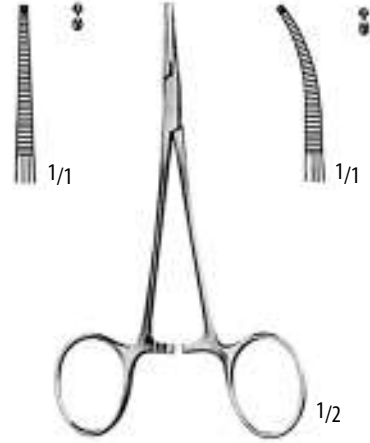

MICRO - MOSQUITO 1 : 2

HM - 438 - 10 HM - 439 - 10
HM - 438 - 12 HM - 439 - 12

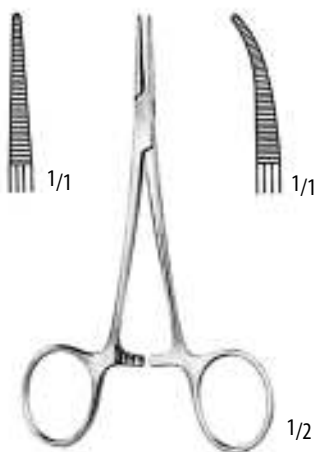

HALSTED - MOSQUITO

HM - 440 - 12 HM - 441 - 12
HM - 440 - 14 HM - 441 - 14

12,5 cm / 5"
14,0 cm / 5¹/₂"

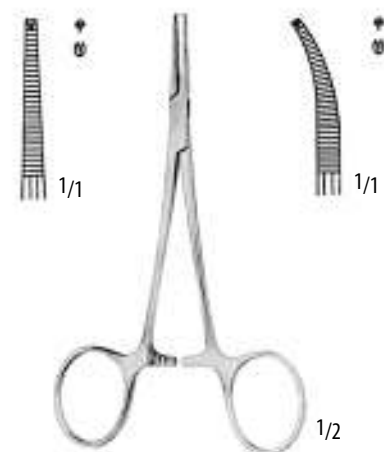

HALSTED - MOSQUITO 1 : 2

HM - 442 - 12 HM - 443 - 12
HM - 442 - 14 HM - 443 - 14

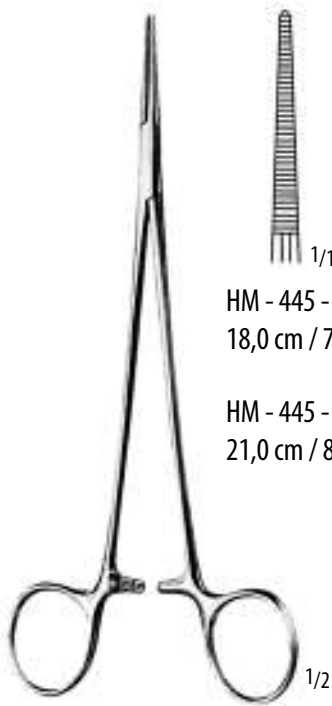

HM - 445 - 18
18,0 cm / 7"

HM - 445 - 21
21,0 cm / 8 1/4"

HALSTED



HM - 446 - 18
18,0 cm / 7"

HM - 446 - 21
21,0 cm / 8 1/4"

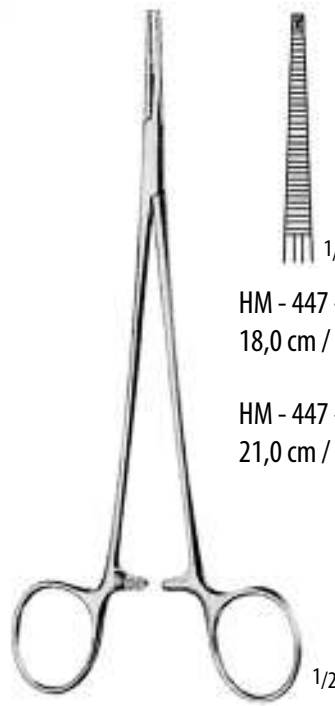

HM - 447 - 18
18,0 cm / 7"

HM - 447 - 21
21,0 cm / 8 1/4"

HALSTED 1 : 2



HM - 448 - 18
18,0 cm / 7"

HM - 448 - 21
21,0 cm / 8 1/4"

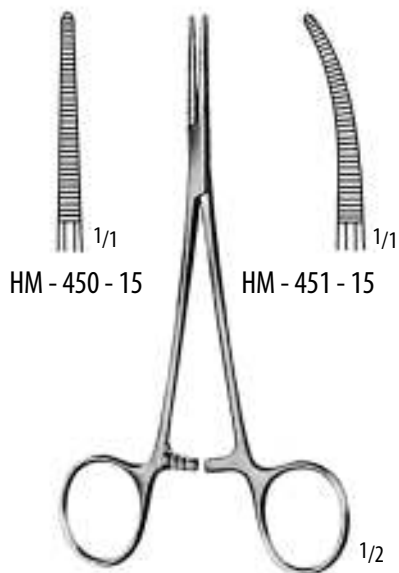

HM - 450 - 15

HM - 451 - 15

LERICHE
15,0 cm / 6"

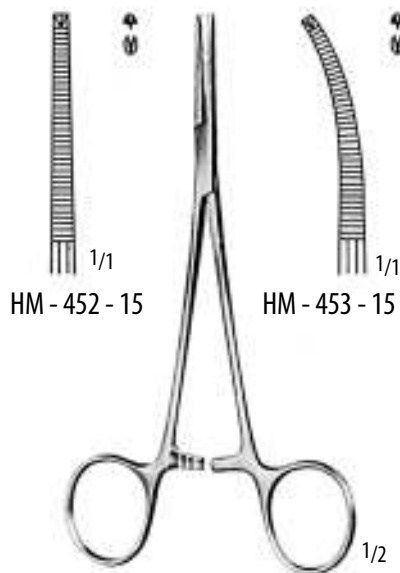

HM - 452 - 15

HM - 453 - 15

LERICHE 1 : 2
15,0 cm / 6"

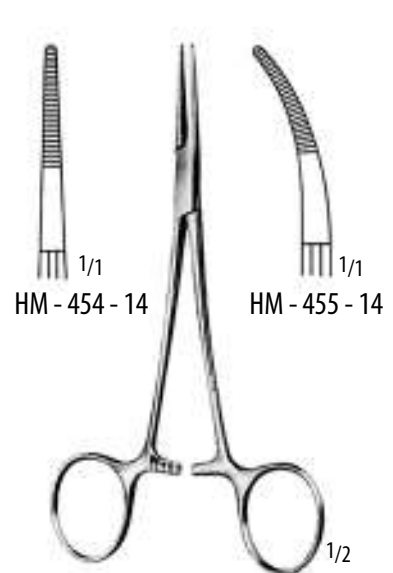
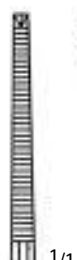

HM - 454 - 14

HM - 455 - 14

PROVIDENCE - HOSPITAL
14,0 cm / 5 1/2"



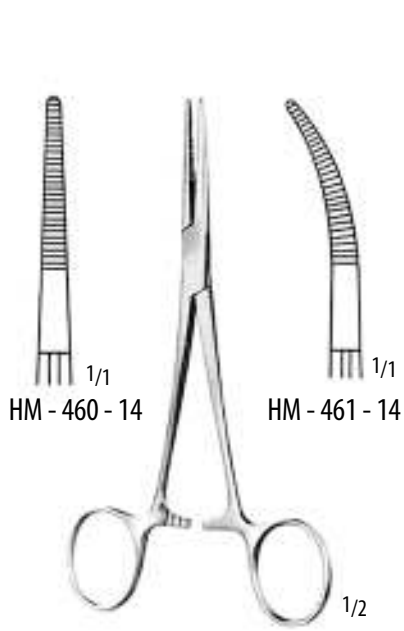

HM - 460 - 14

HM - 461 - 14

KELLY

14,0 cm / 5 1/2"

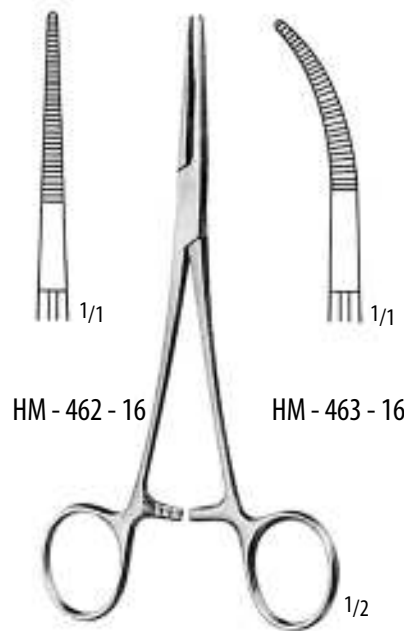

HM - 462 - 16

HM - 463 - 16

KELLY - RANKIN

16,0 cm / 6 1/4"

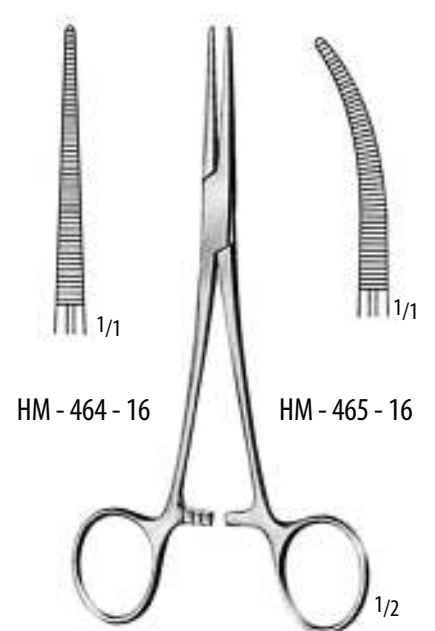

HM - 464 - 16

HM - 465 - 16

COLLER

14,0 cm / 5 1/2"

16,0 cm / 6 1/4"

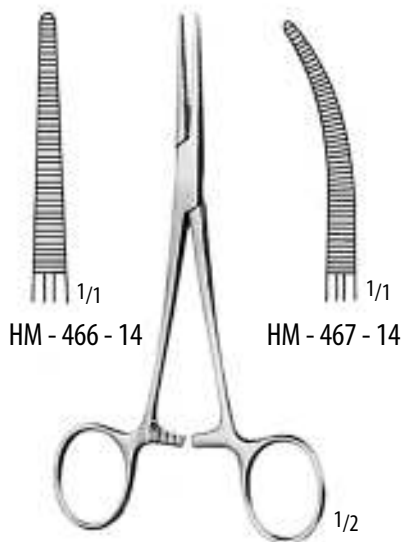

HM - 466 - 14

HM - 467 - 14

CRILE

14,0 cm / 5 1/2"

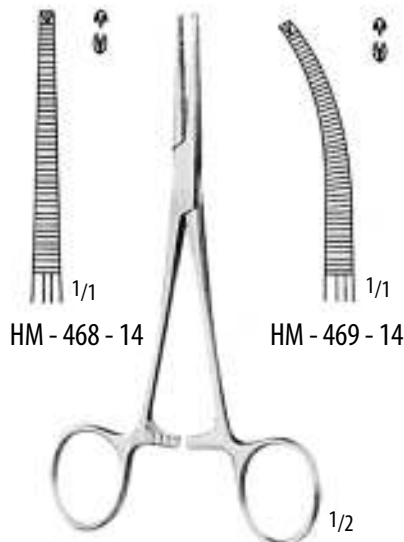

HM - 468 - 14

HM - 469 - 14

CRILE 1 : 2

14,0 cm / 5 1/2"

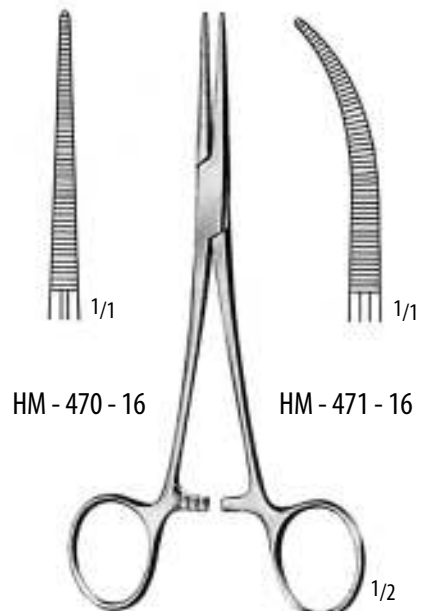

HM - 470 - 16

HM - 471 - 16

CRILE - RANKIN

16,0 cm / 6 1/4"

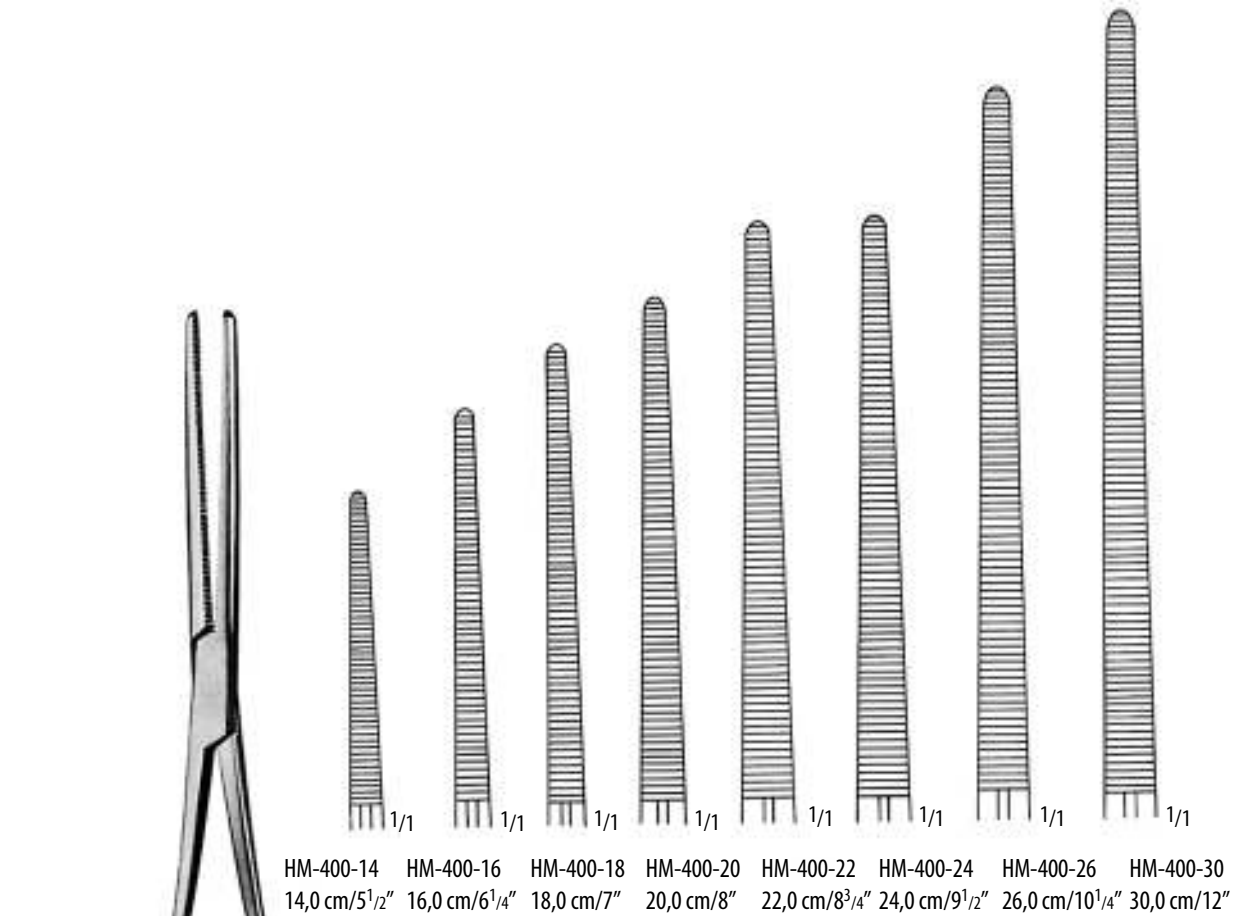

ROCHESTER - PEAN

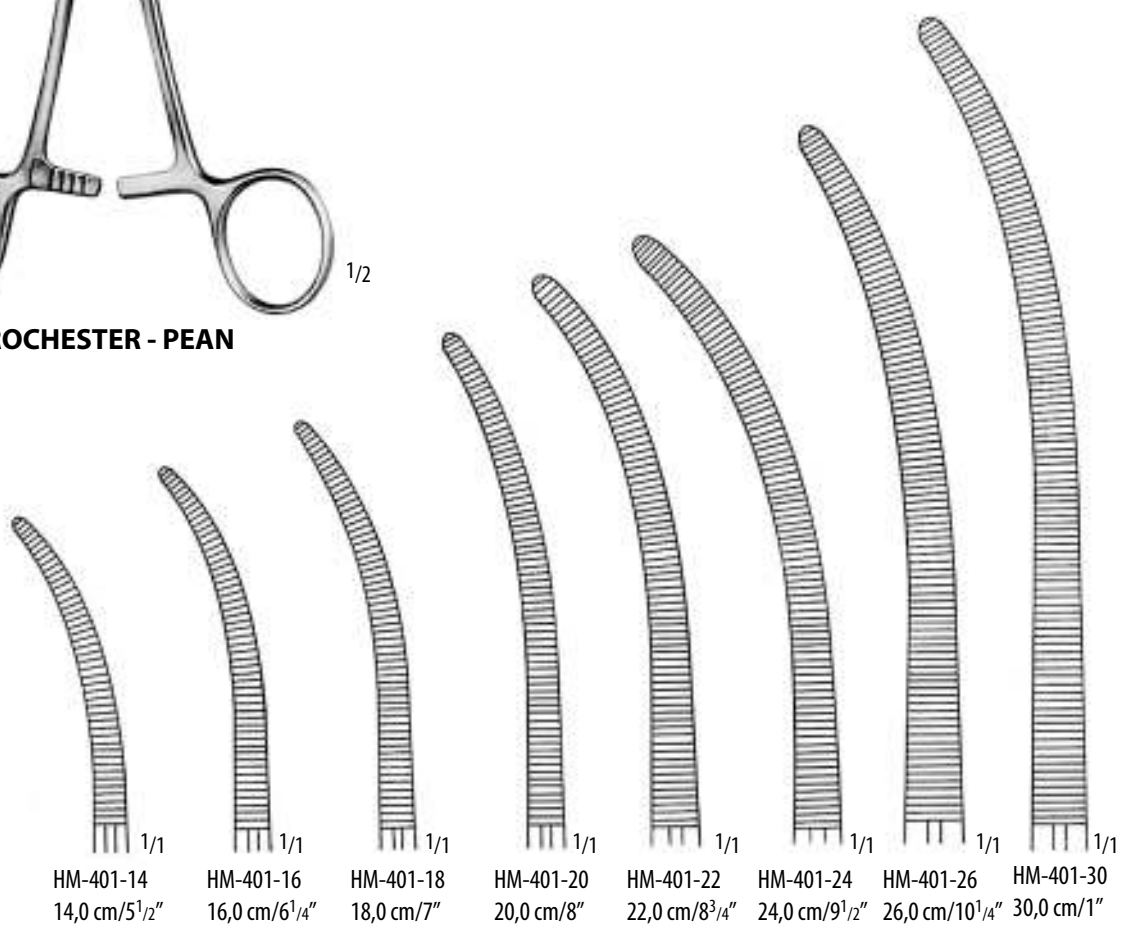

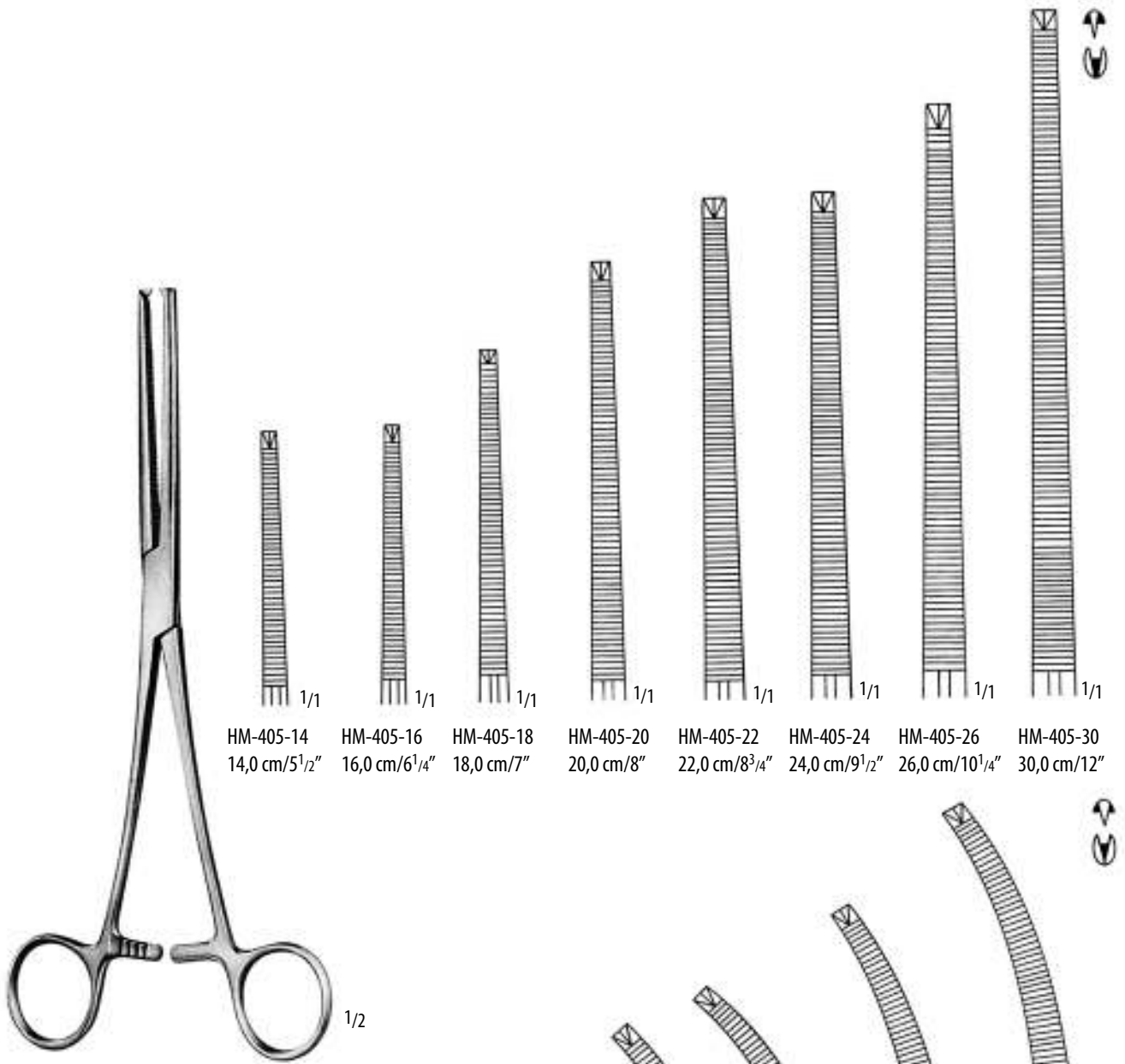

OCHSNER - KOCHER 1 : 2

HM-405-14	HM-405-16	HM-405-18	HM-405-20	HM-405-22	HM-405-24	HM-405-26	HM-405-30
14,0 cm/5 ¹ / ₂ "	16,0 cm/6 ¹ / ₄ "	18,0 cm/7"	20,0 cm/8"	22,0 cm/8 ³ / ₄ "	24,0 cm/9 ¹ / ₂ "	26,0 cm/10 ¹ / ₄ "	30,0 cm/12"

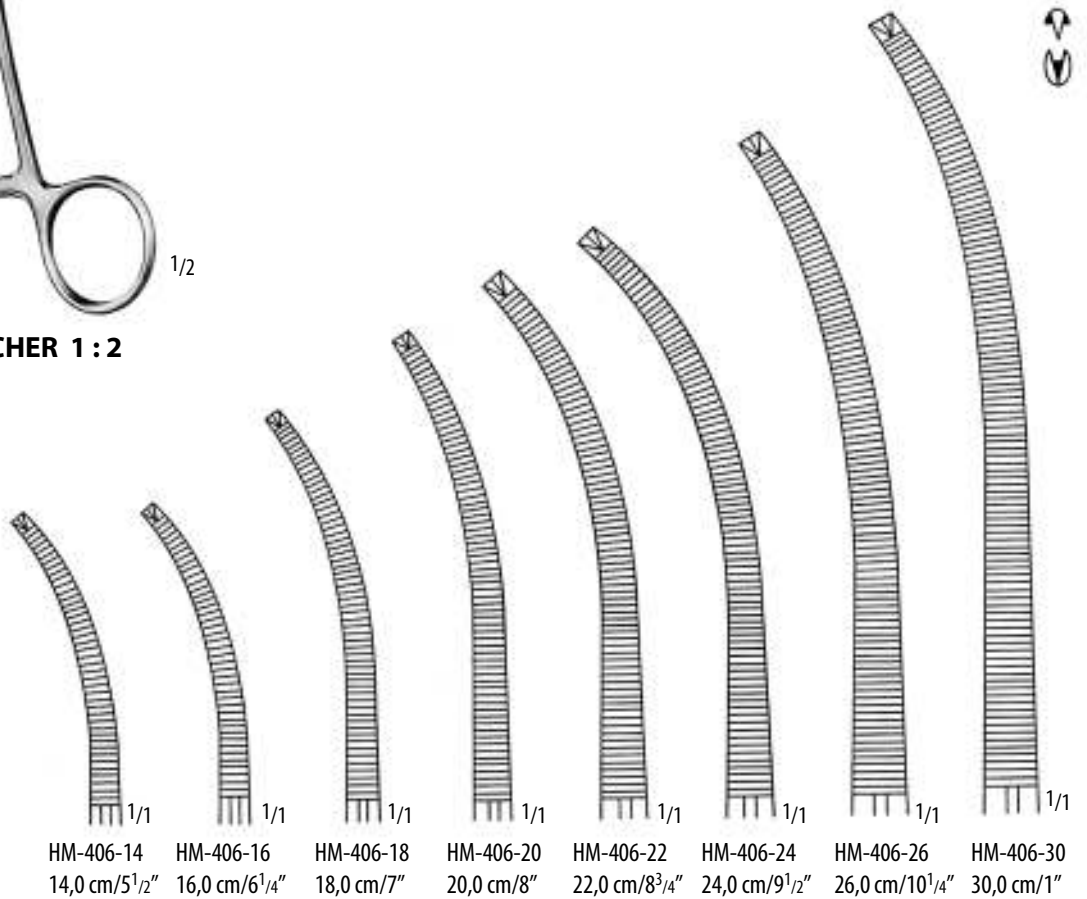

HM-406-14	HM-406-16	HM-406-18	HM-406-20	HM-406-22	HM-406-24	HM-406-26	HM-406-30
14,0 cm/5 ¹ / ₂ "	16,0 cm/6 ¹ / ₄ "	18,0 cm/7"	20,0 cm/8"	22,0 cm/8 ³ / ₄ "	24,0 cm/9 ¹ / ₂ "	26,0 cm/10 ¹ / ₄ "	30,0 cm/12"

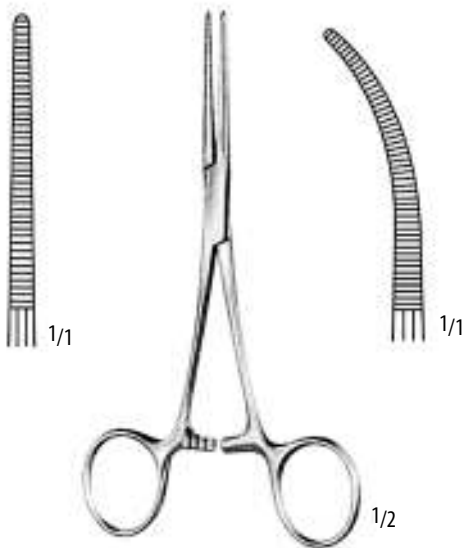

PEAN - DELICATE

HM - 427 - 13	HM - 428 - 13
HM - 427 - 14	HM - 428 - 14
HM - 427 - 16	HM - 428 - 16

13,0 cm / 5"
14,0 cm / 5 1/2"
16,0 cm / 6 1/4"

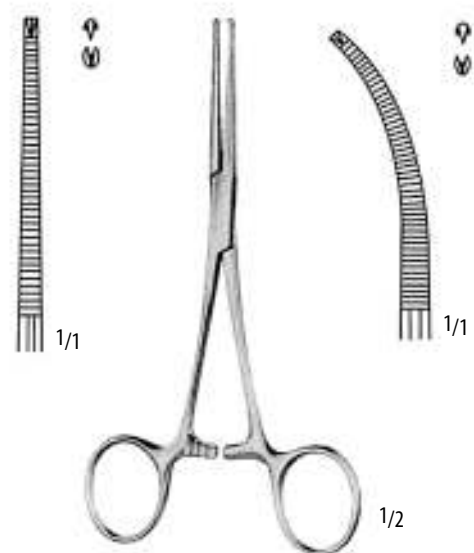

KOCHER 1 : 2 - DELICATE

HM - 429 - 13	HM - 432 - 13
HM - 429 - 14	HM - 432 - 14
HM - 429 - 16	HM - 432 - 16



**OVERHOLT -
GEISSENDOERFER**

21,0 cm / 8 1/4"
27,0 cm / 10 3/4"

1/2



Fig. 1 1/1

21,0 cm / 8 1/4"
27,0 cm / 10 3/4"

HM - 420 - 01
HM - 421 - 01



Fig. 2 1/1

HM - 420 - 02
HM - 421 - 02



Fig. 3 1/1

HM - 420 - 03
HM - 421 - 03

1/1

1/1



Fig. 4 1/1

21,0 cm / 8 1/4"
27,0 cm / 10 3/4"

HM - 422 - 04
HM - 423 - 04

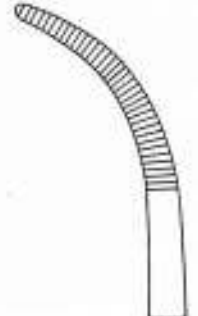

Fig. 5 1/1

HM - 422 - 05
HM - 423 - 05

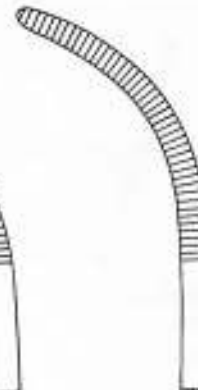

Fig. 6 1/1

HM - 422 - 06
HM - 423 - 06



Fig. 7 1/1

HM - 422 - 07
HM - 423 - 07



BABY - OVERHOLT

HM - 424 - 13
13,5 cm / 5 1/4"

1/2

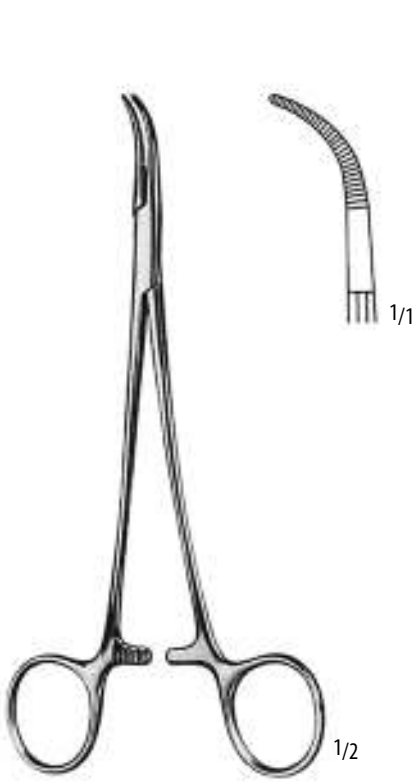

OVERHOLT
HM - 426 - 18
18,5 cm / 7 1/2"



OVERHOLT
HM - 426 - 20
20,5 cm / 8"

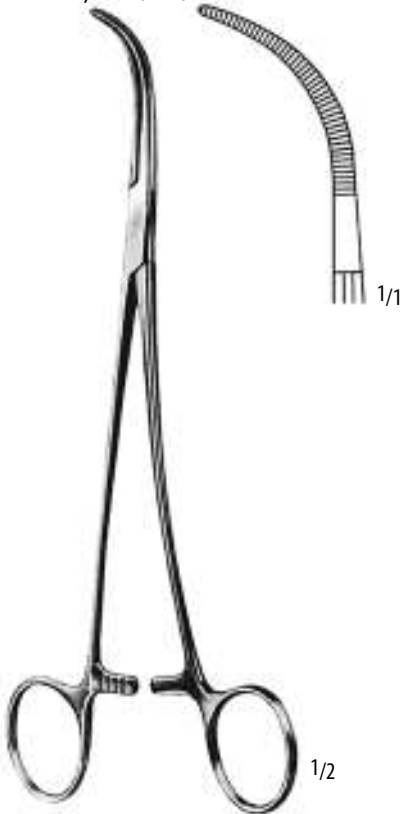

OVERHOLT
HM - 426 - 21
21,0 cm / 8 1/2"

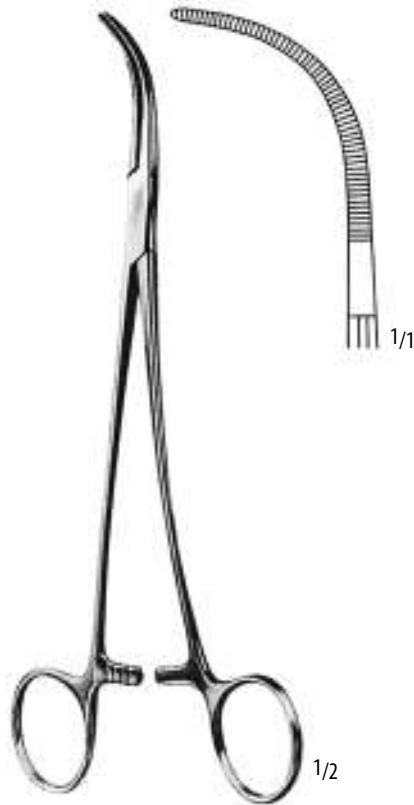

OVERHOLT
HM - 426 - 22
21,5 cm / 8 1/2"



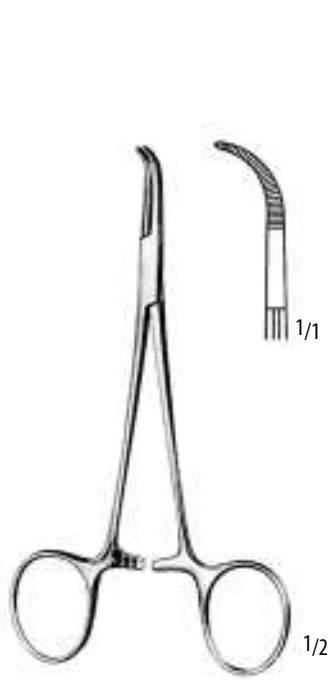

BABY - ADSON

HM - 415 - 14
14,0 cm / 5 1/2"



BABY - ADSON

HM - 415 - 18
18,0 cm / 7"

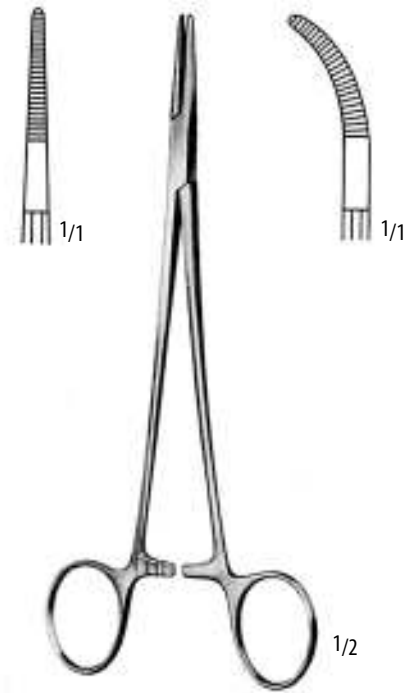

ADSON

HM - 418 - 19
18,5 cm / 7 1/4"



HM - 418 - 18



HM - 419 - 18

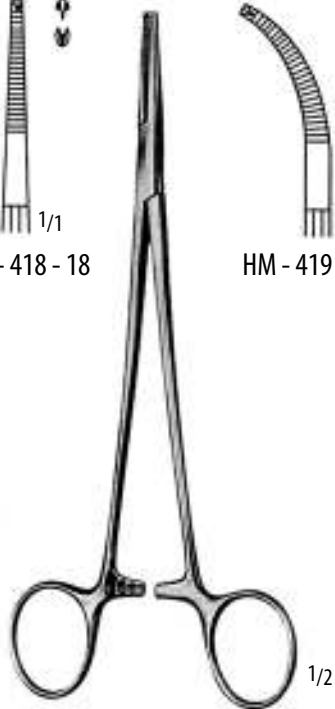

ADSON 1 : 2

18,5 cm / 7 1/4"



MEEKER

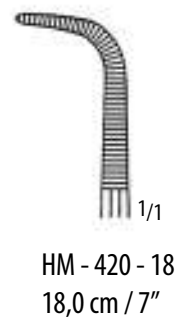

HM - 420 - 18
18,0 cm / 7"

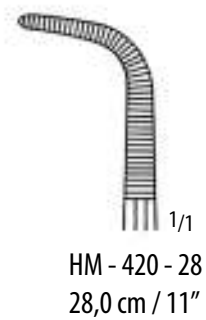

HM - 420 - 28
28,0 cm / 11"



DIXON - LOVELACE

HM - 422 - 15

15,5 cm / 6"



DIXON - LOVELACE 1 : 2

HM - 423 - 15

15,5 cm / 6"

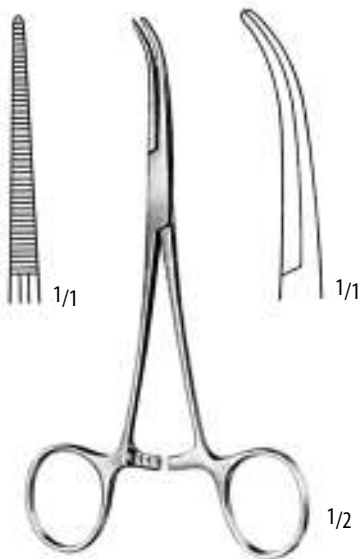

DANDY

HM - 424 - 14

14,0 cm / 5 1/2"

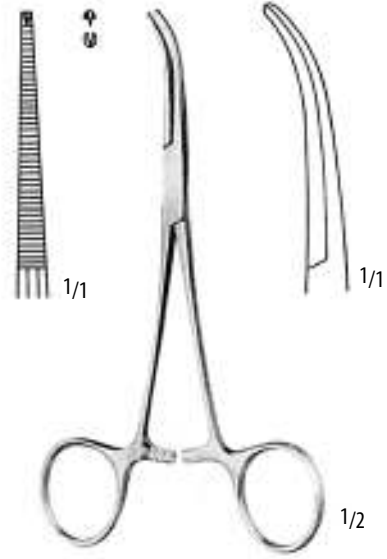

DANDY 1 : 2

HM - 425 - 14

14,0 cm / 5 1/2"

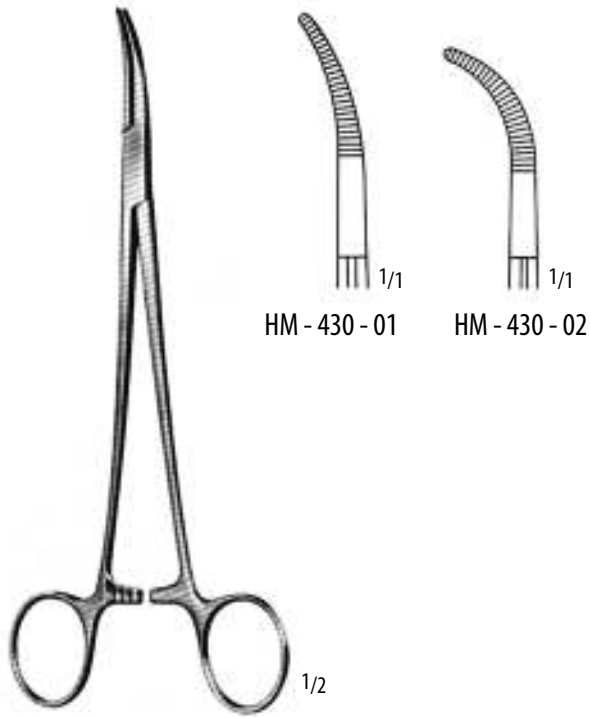

HM - 430 - 01

HM - 430 - 02

SCHNIDT - SAWTELL
19,0 cm / 7 1/2"

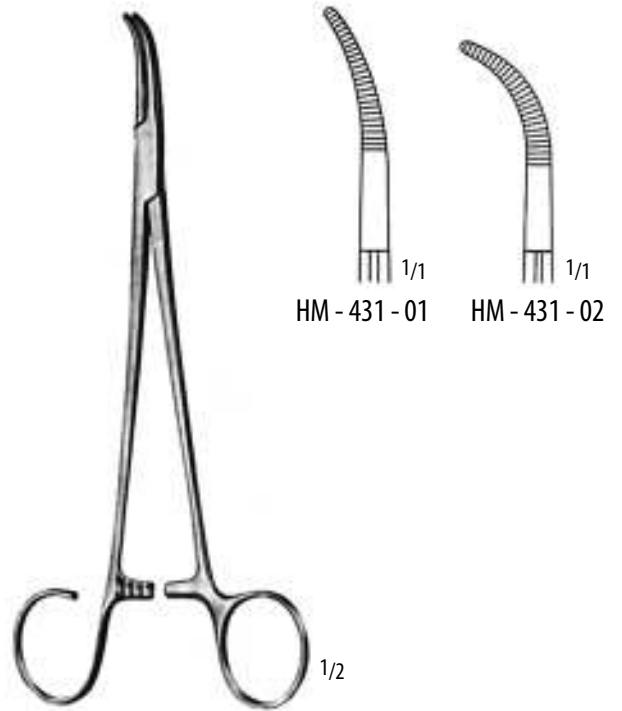

HM - 431 - 01

HM - 431 - 02

SCHNIDT - SAWTELL
19,0 cm / 7 1/2"

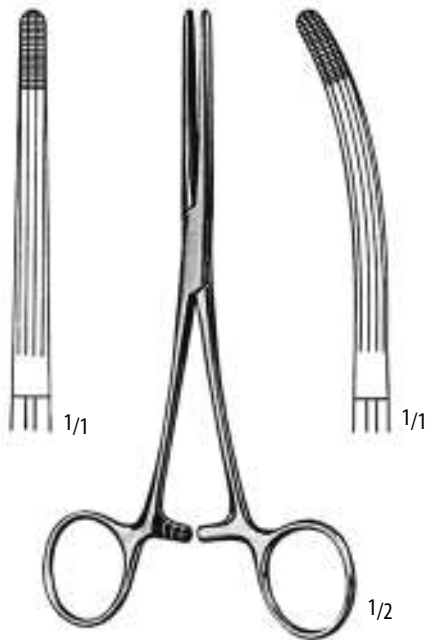

ROCHESTER - CARMALT

HM - 440 - 16	16,0 cm / 6 1/4"	HM - 441 - 16
HM - 440 - 20	20,0 cm / 8"	HM - 441 - 20

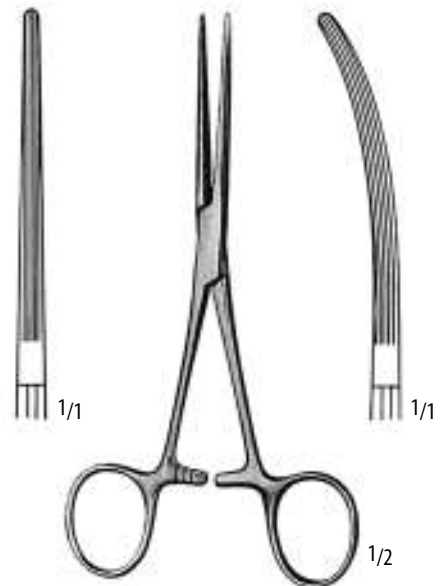

BAINBRIDGE

HM - 442 - 15	15,0 cm / 6"	HM - 443 - 15
HM - 442 - 18	18,5 cm / 7 1/4"	HM - 443 - 18

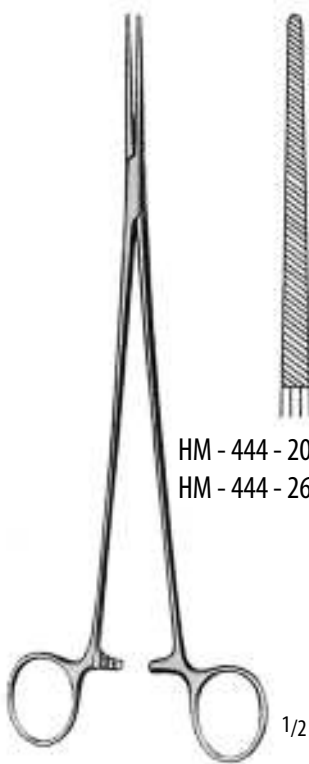

BENGOLEA



1/1

HM - 444 - 20 20,0 cm / 8"
HM - 444 - 26 26,0 cm / 10 1/2"



1/1

HM - 445 - 20
HM - 445 - 26

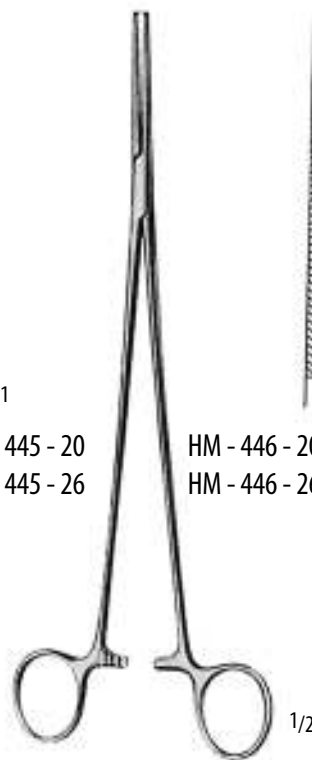

BENGOLEA 1 : 2



1/1

HM - 446 - 20 20,0 cm / 8"
HM - 446 - 26 26,0 cm / 10 1/2"



1/1

HM - 447 - 20
HM - 447 - 26

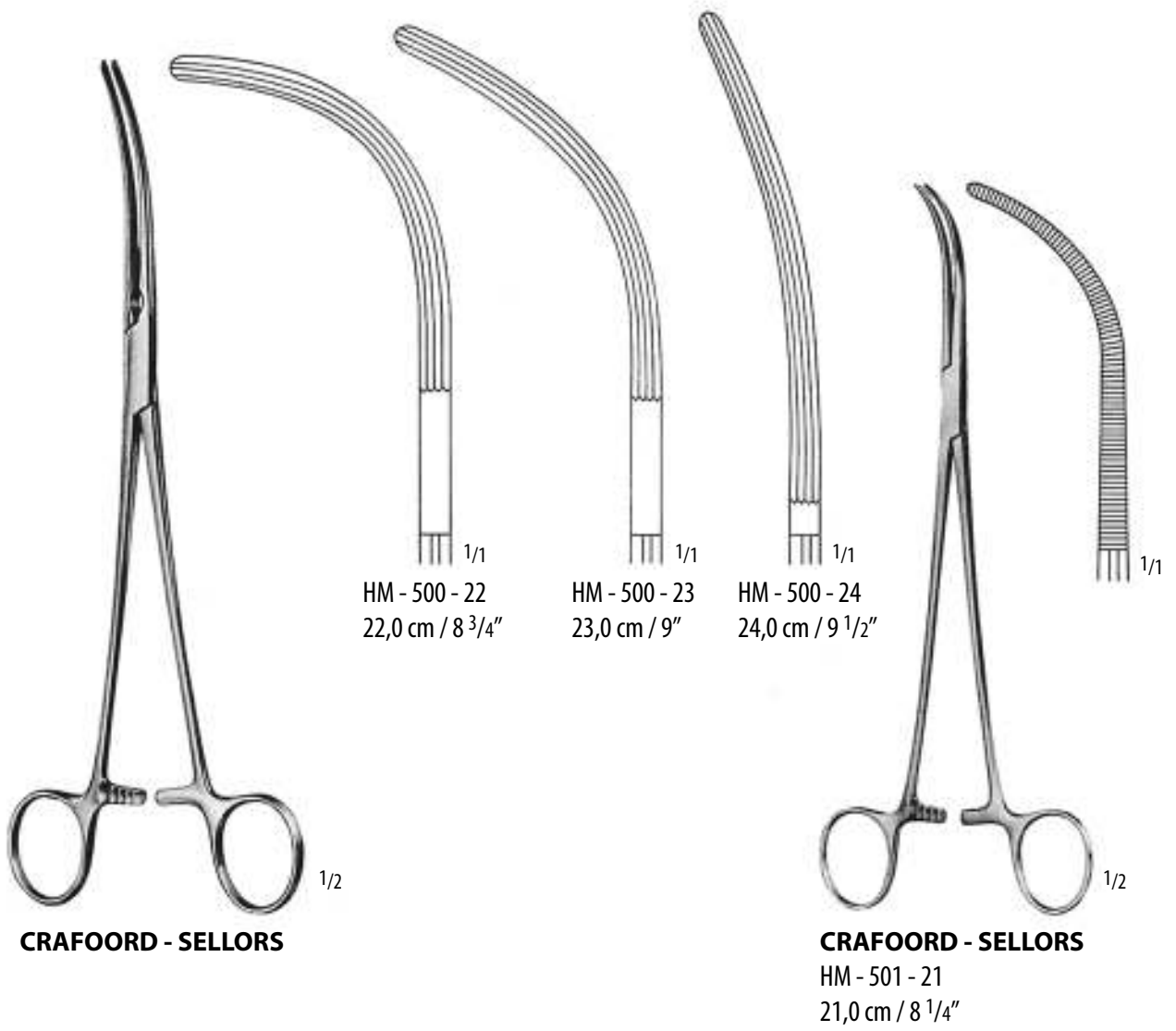

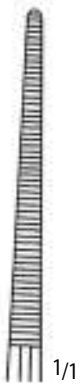

Fig. 1
HM - 505 - 01



Fig. 2
HM - 505 - 02



Fig. 3
HM - 505 - 03

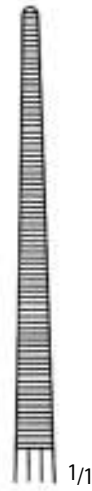

HM - 506 - 22

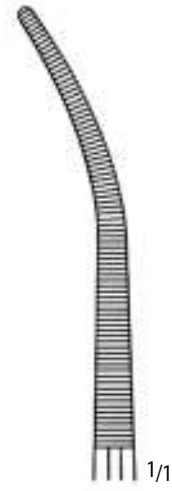

HM - 507 - 23



HEISS
20,0 cm / 8"



HM - 508 - 24

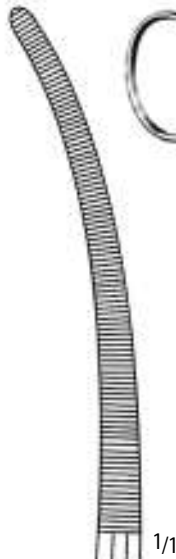

HM - 509 - 24



ROBERTS
22,0 cm / 8³/₄"

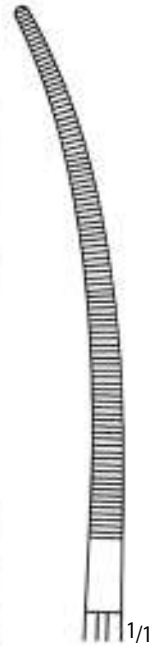

CRAFOORD
HM - 510 - 24
24,0 cm / 9¹/₂"

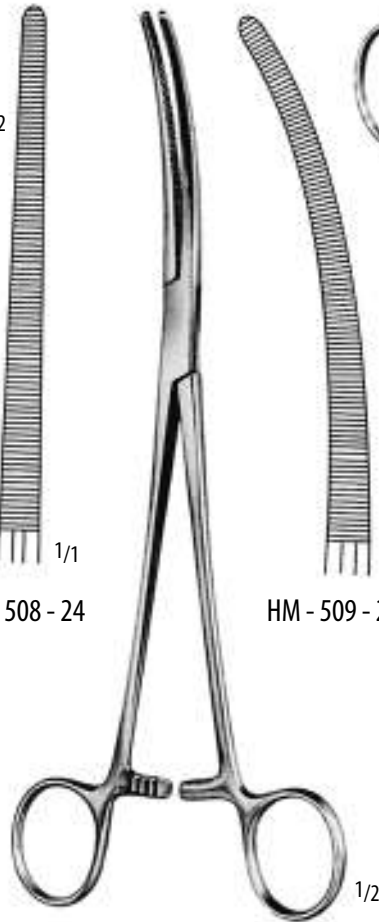

SAROT
24,0 cm / 9¹/₂"



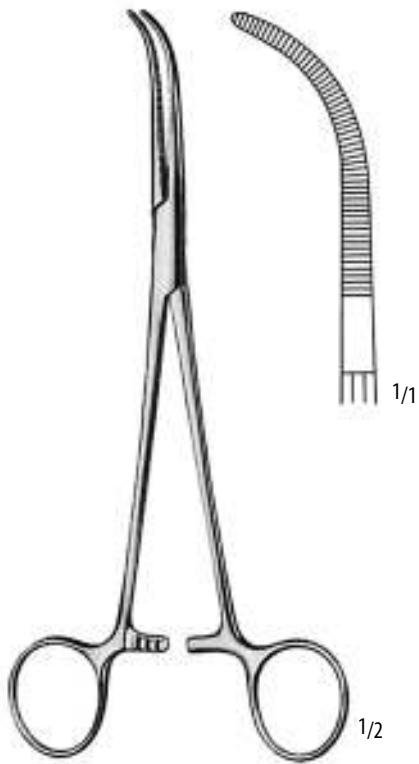

JOHNS HOPKINS
HM - 516 - 20
20,0 cm / 8"

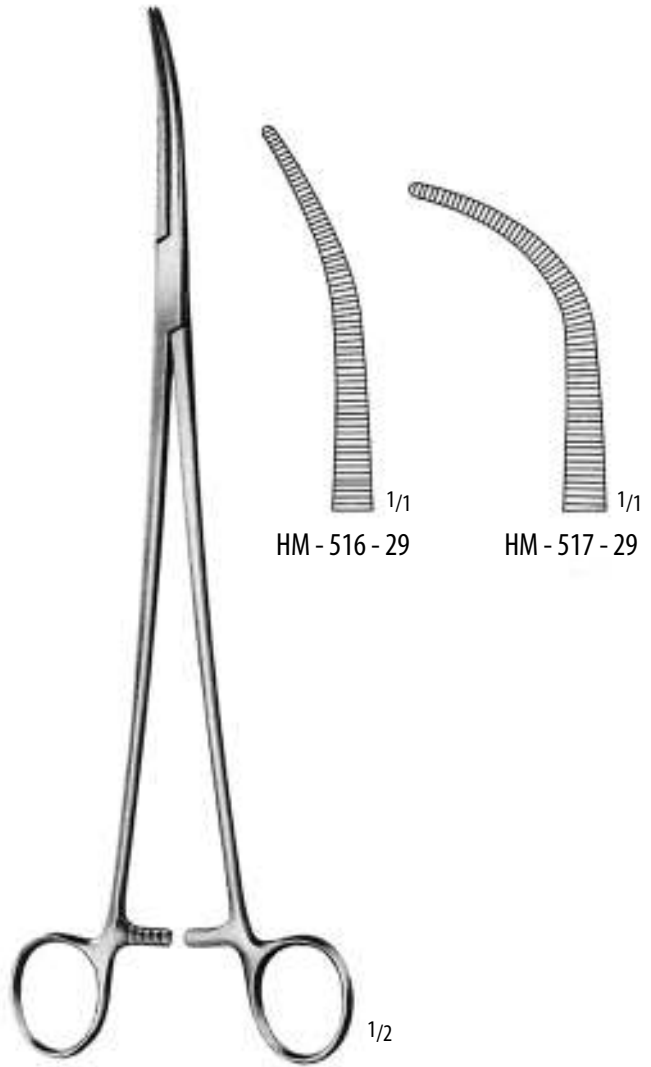

ZENKER
29,5 cm / 11 1/2"

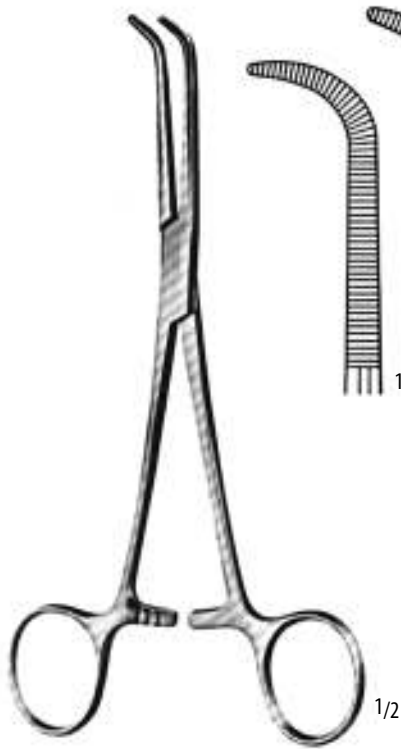

MIXTER
15,5 cm / 6" HM - 520 - 15
19,0 cm / 7 1/2" HM - 520 - 19

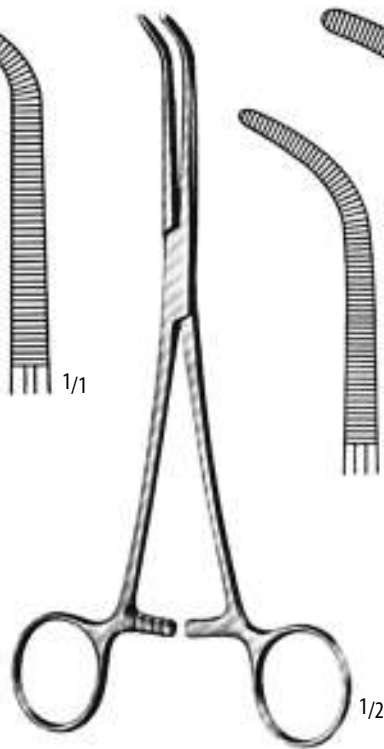

MIXTER - O'SHAUGHNESSY
15,5 cm / 6" HM - 521 - 15
19,0 cm / 7 1/2" HM - 521 - 19

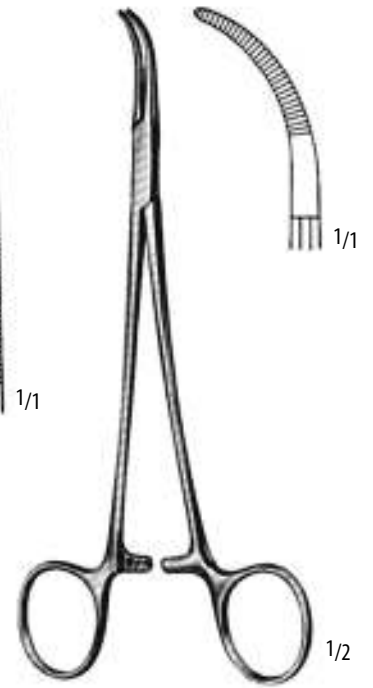

BABY - MIXTER
HM - 522 - 18
18,0 cm / 7"



BABY - MIXTER
14,0 cm / 5 1/2"

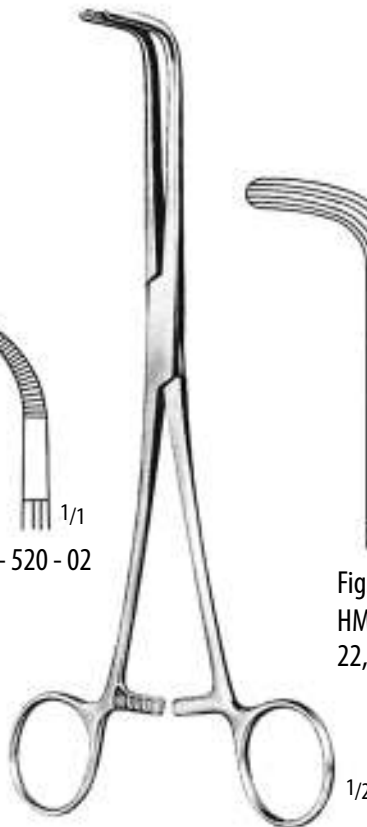

MIXTER

Fig. 1
HM - 521 - 22
22,0 cm / 8 1/4"

Fig. 2
HM - 521 - 25
25,0 cm / 10"

Fig. 3
HM - 521 - 28
28,0 cm / 11"

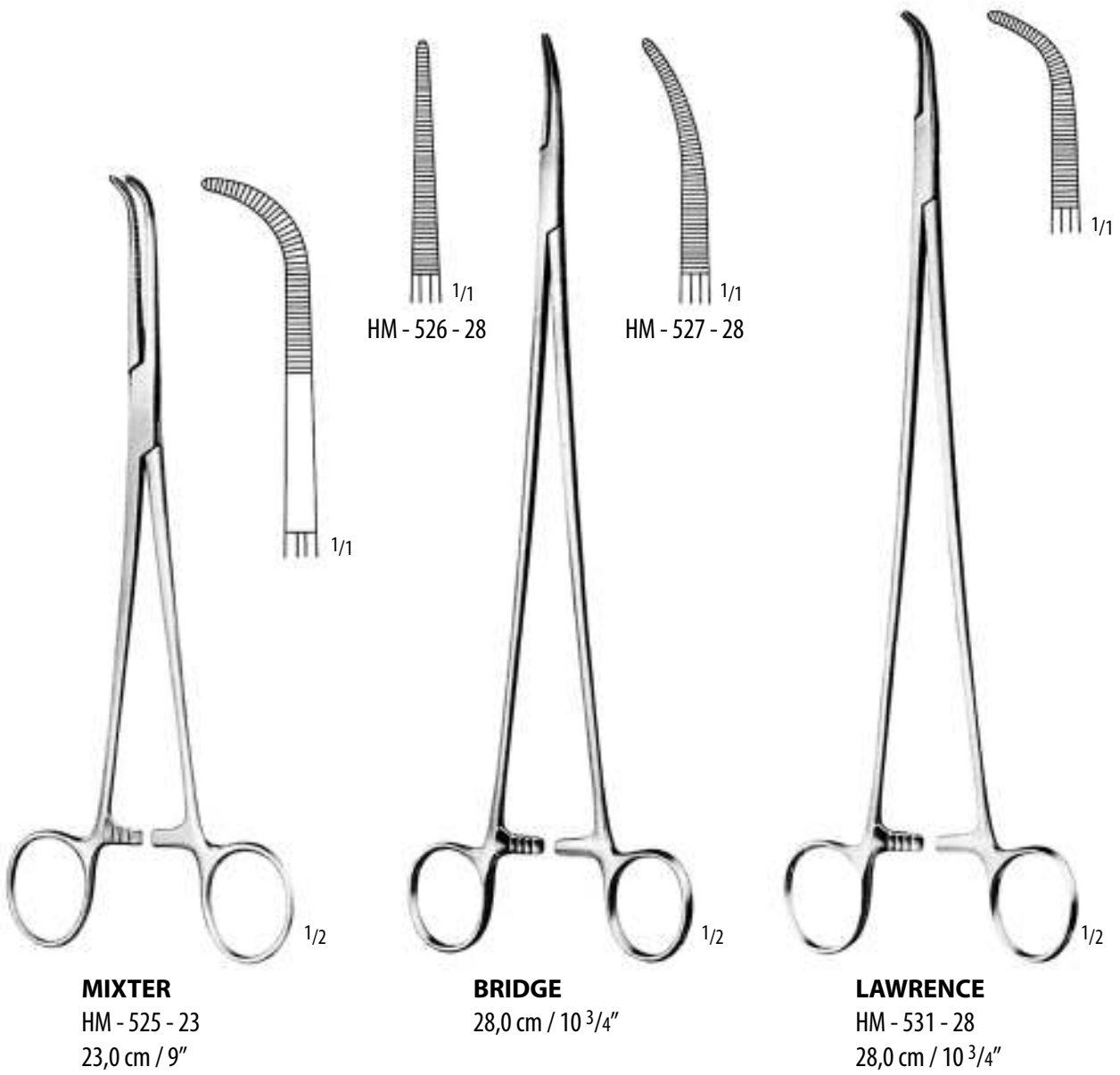



KANTROWITZ

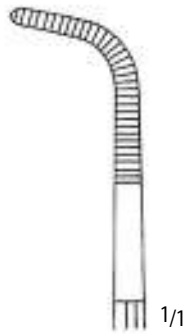

HM - 530 - 20
20,0 cm / 8"



HM - 530 - 24
24,0 cm / 9 1/2"



HM - 530 - 28
28,0 cm / 11"

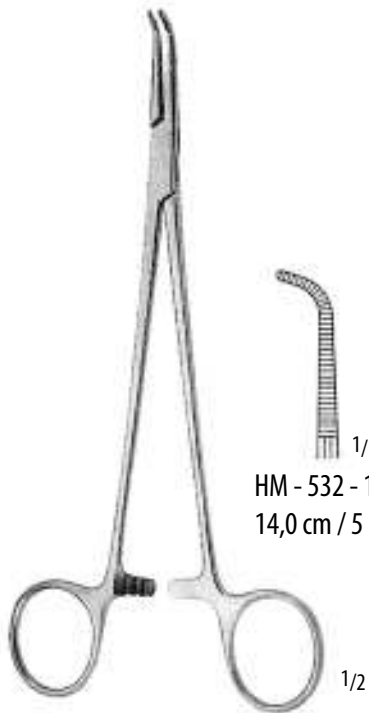

GEMINI

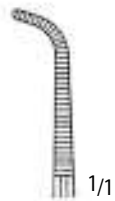

HM - 532 - 14
14,0 cm / 5 1/2"

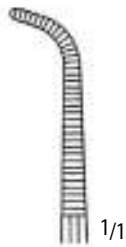

HM - 532 - 18
18,0 cm / 7"



HM - 532 - 22
22,0 cm / 8 3/4"

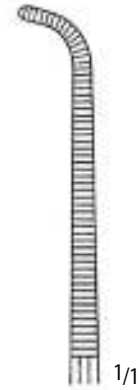

HM - 532 - 25
25,0 cm / 10"

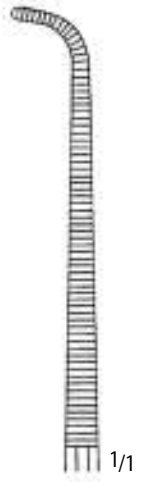

HM - 532 - 28
28,0 cm / 11"



TOENNIS
21,0 cm / 8 1/4"
26,0 cm / 10 1/4"



HM - 533 - 21
HM - 533 - 26



HM - 534 - 21
HM - 534 - 26

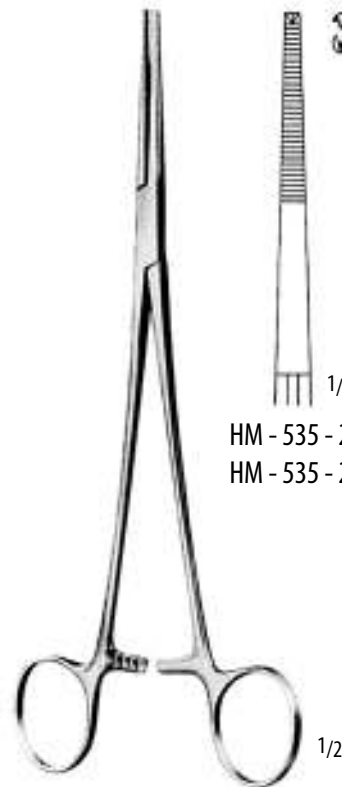

TOENNIS 1 : 2
21,0 cm / 8 1/4"
26,0 cm / 10 1/4"



HM - 535 - 21
HM - 535 - 26



HM - 536 - 21
HM - 536 - 26

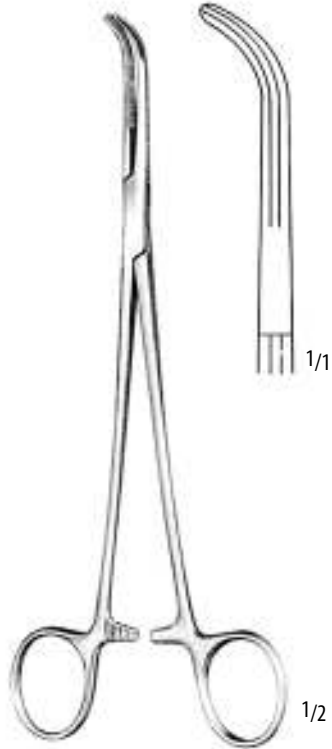

LAHEY
HM - 540 - 19
19,0 cm / 7 1/2"

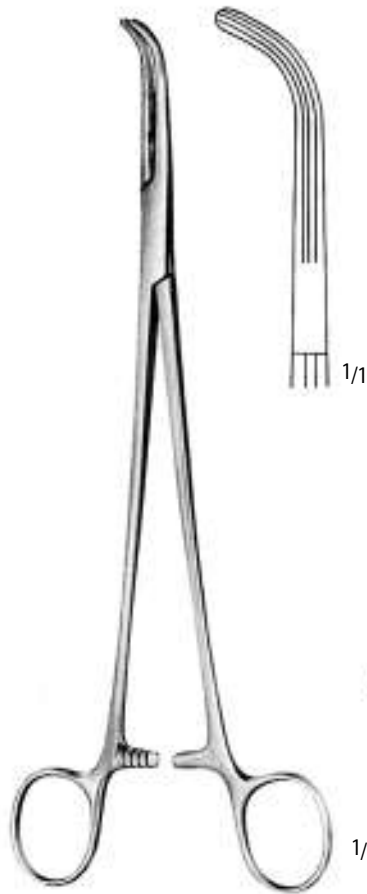

LAHEY
HM - 540 - 23
23,0 cm / 9"



LOWER
HM - 541 - 18
18,0 cm / 7"

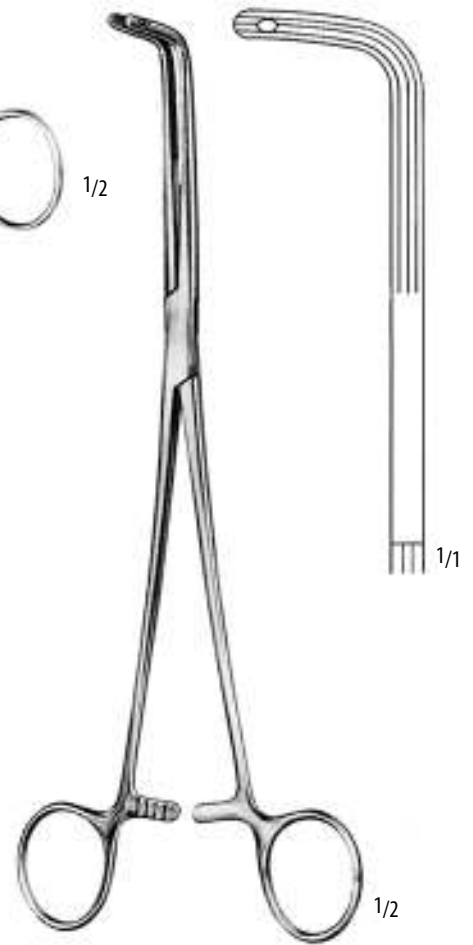

FINOCCHIETTO
HM - 542 - 24
24,0 cm / 9 1/2"

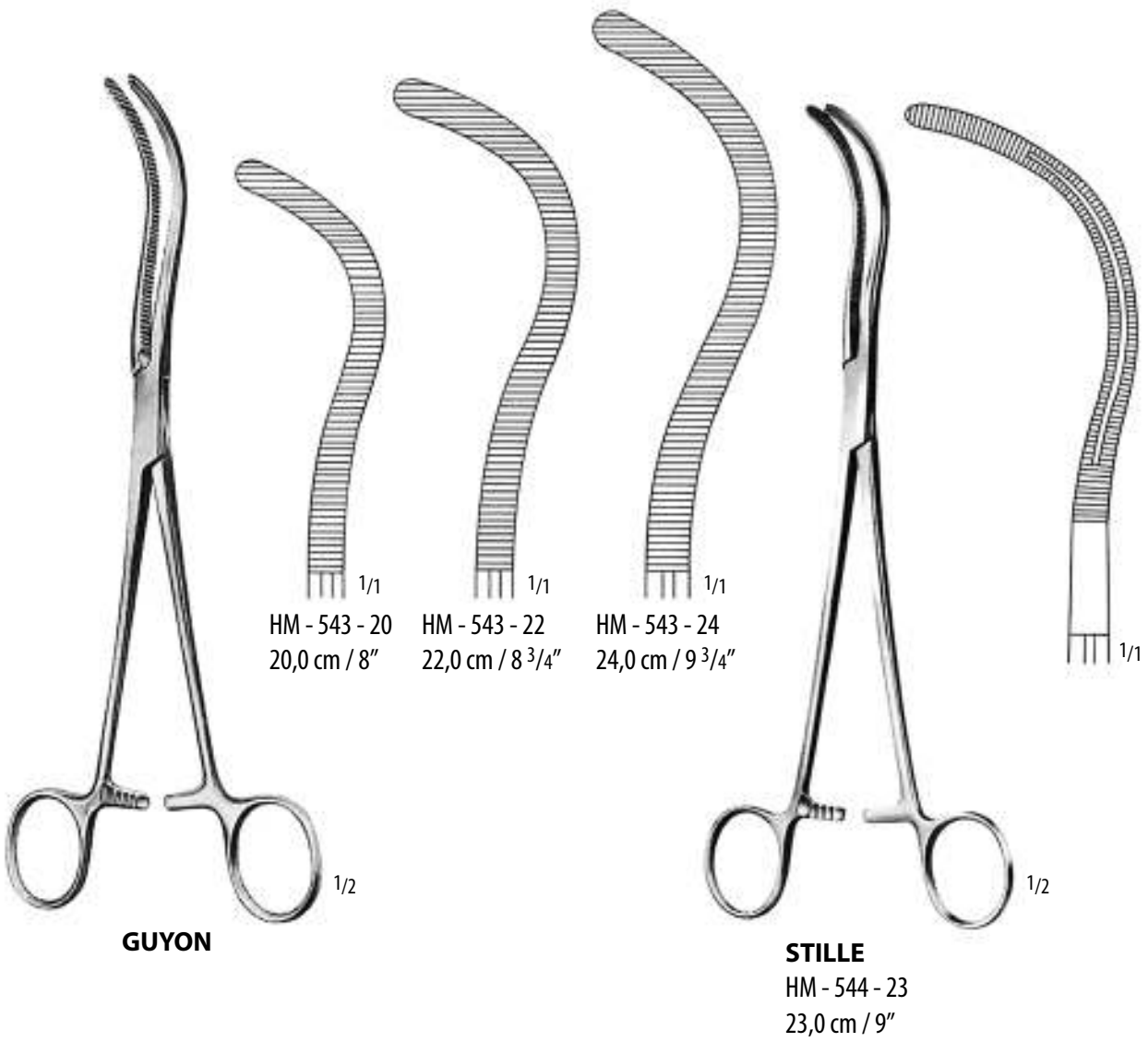

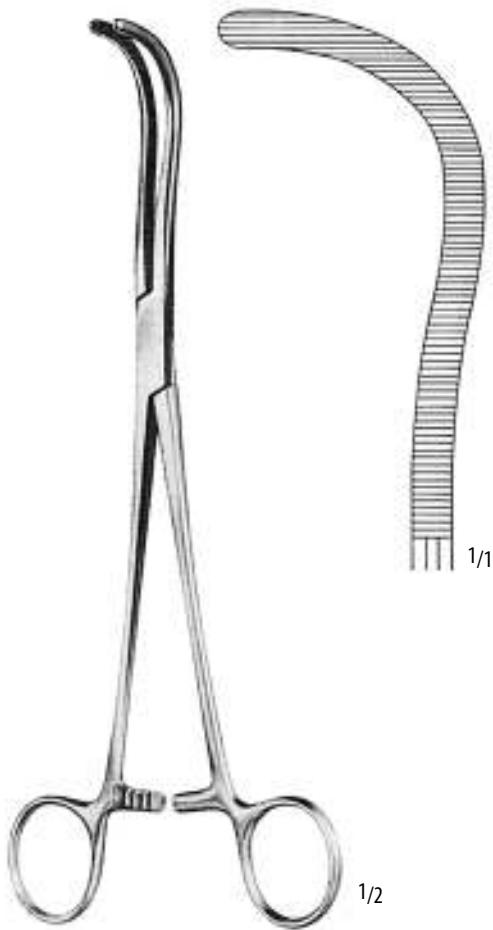

GUYON
HM - 545 - 23
23,0 cm / 9"

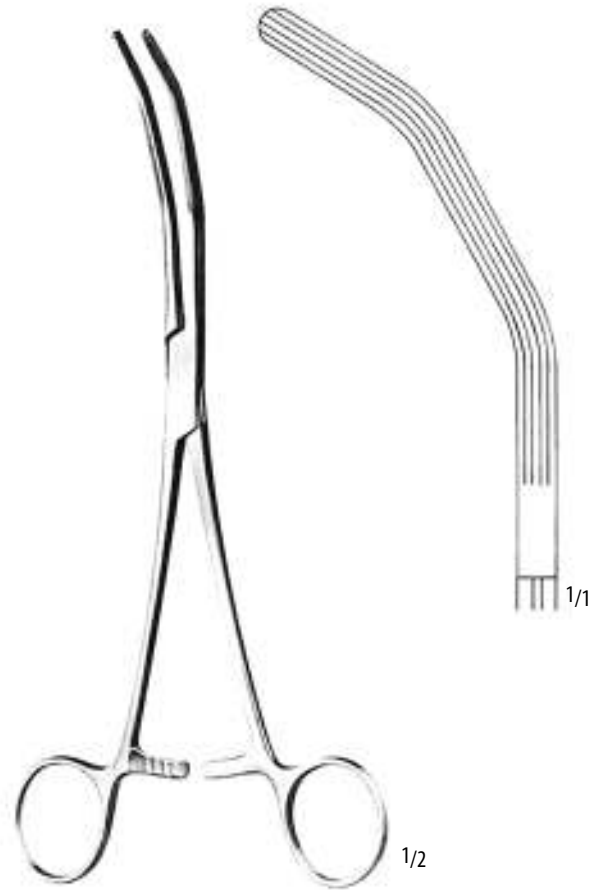

HERRICK
HM - 546 - 23
23,0 cm / 9"

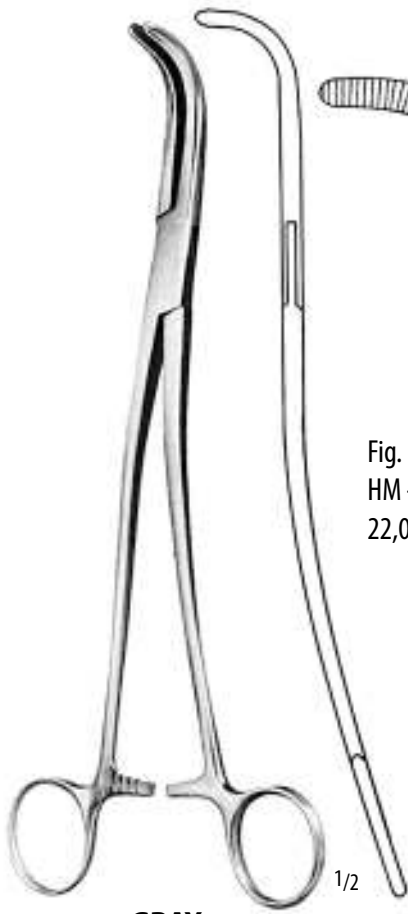

GRAY

Fig. 1
HM - 547 - 22
22,0 cm / 8 3/4"

Fig. 2
HM - 547 - 23
23,0 cm / 9"

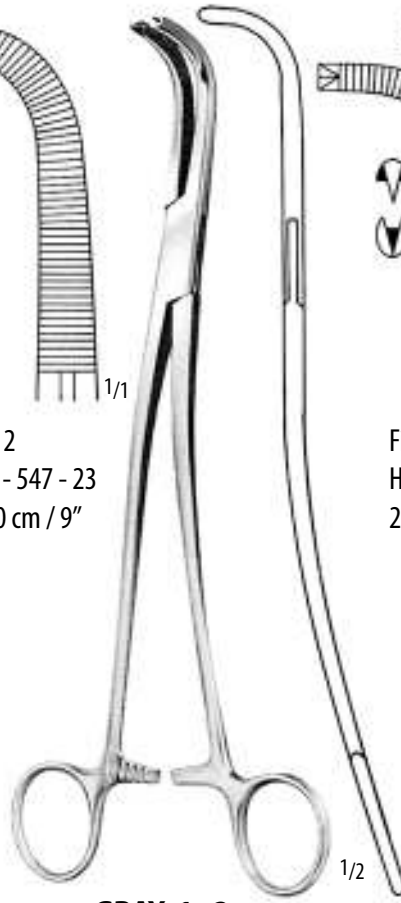

GRAY 1 : 2

Fig. 1
HM - 548 - 22
22,0 cm / 8 3/4"

Fig. 2
HM - 548 - 23
23,0 cm / 9"



DESJARDINS
HM - 549 - 21
21,0 cm / 8 1/4"

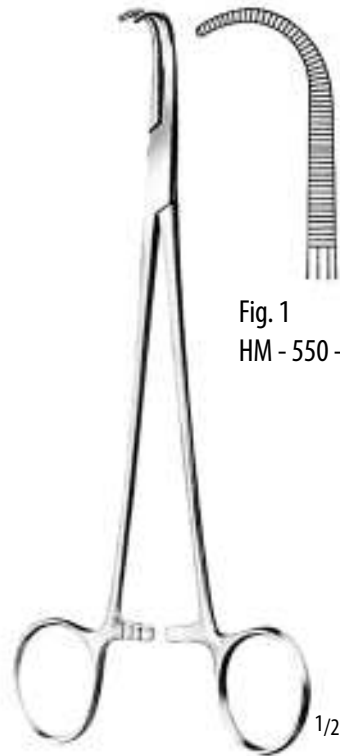

NEGUS
19,0 cm / 7 1/2"

Fig. 1
HM - 550 - 01

Fig. 2
HM - 550 - 02

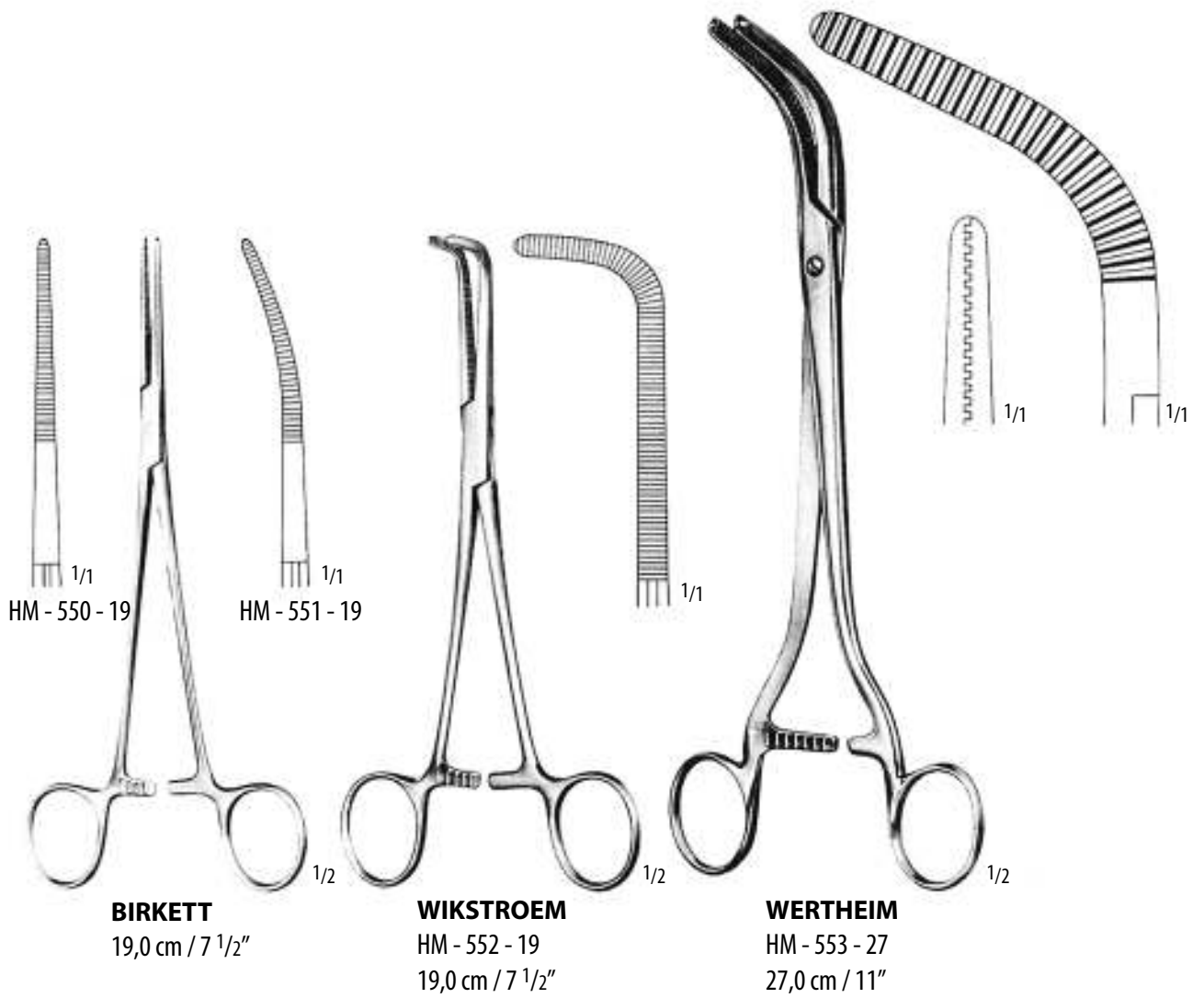

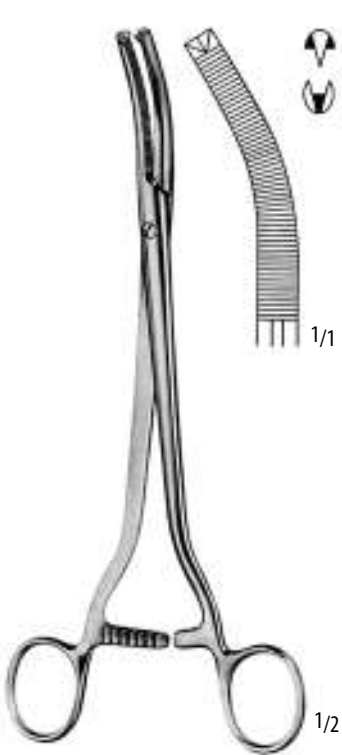

WERTHEIM 1 : 2
 HM - 560 - 24
 24,0 cm / 9 1/2"

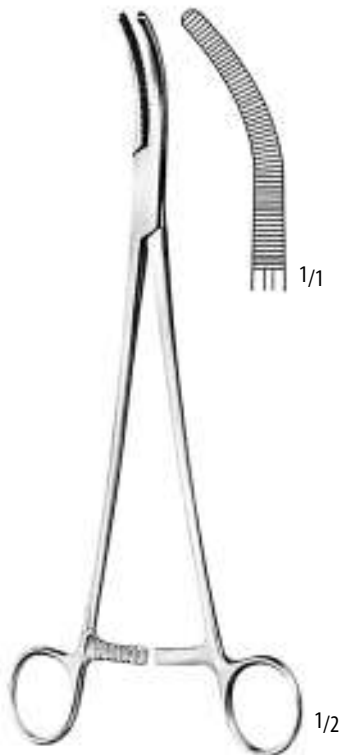

WERTHEIM
 HM - 561 - 25
 25,0 cm / 10"



HM - 562 - 23

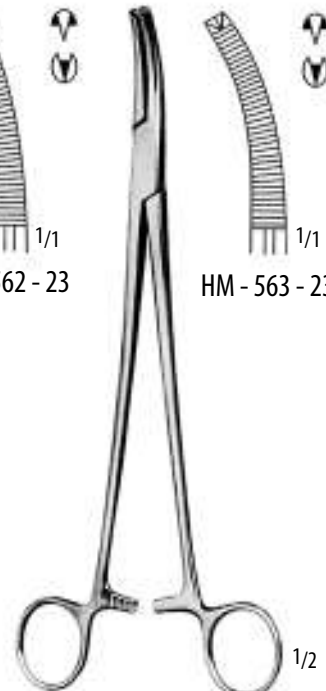

WERTHEIM 1 : 2
 23,0 cm / 9"

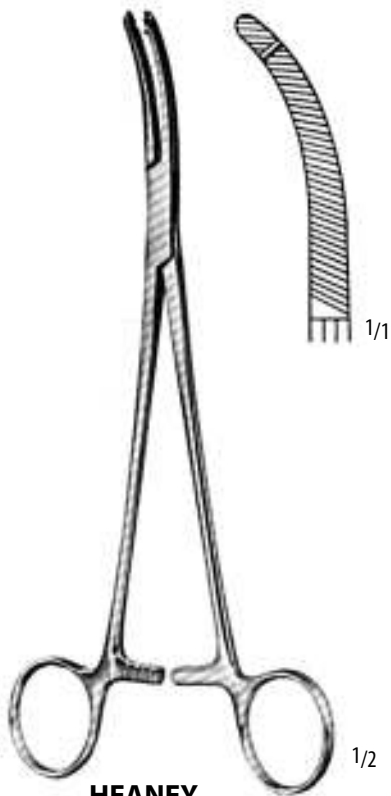

HEANEY
HM - 570 - 21
21,0 cm / 8 1/4"

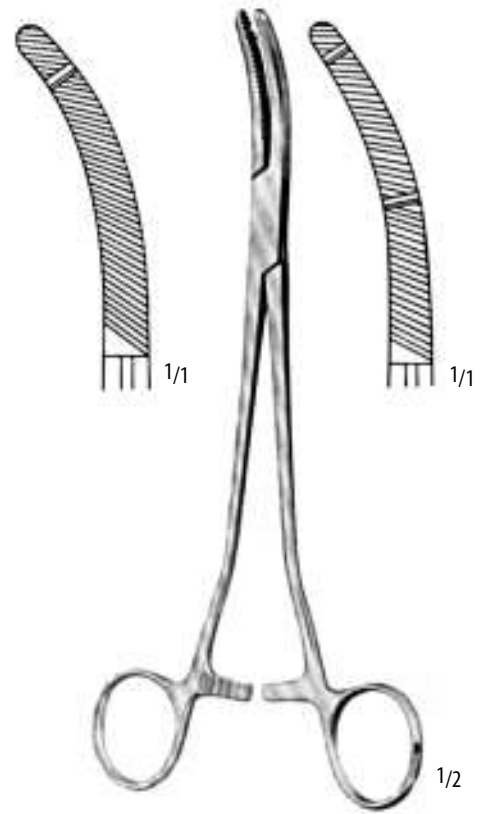

HEANEY
HM - 571 - 21 21,0 cm / 8 1/4" HM - 572 - 21
HM - 571 - 23 23,0 cm / 9" HM - 572 - 23

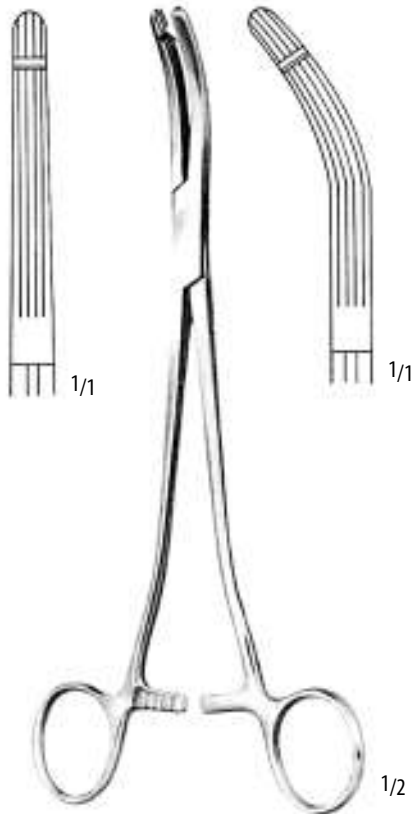

HEANEY - BALLANTINE
HM - 575 - 21 21,0 cm / 8 1/4" HM - 576 - 21

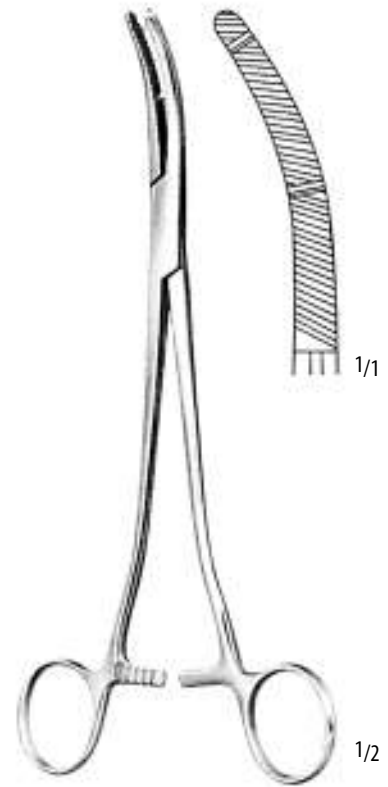

HEANEY - KANTER
HM - 577 - 21
21,0 cm / 8 1/4"

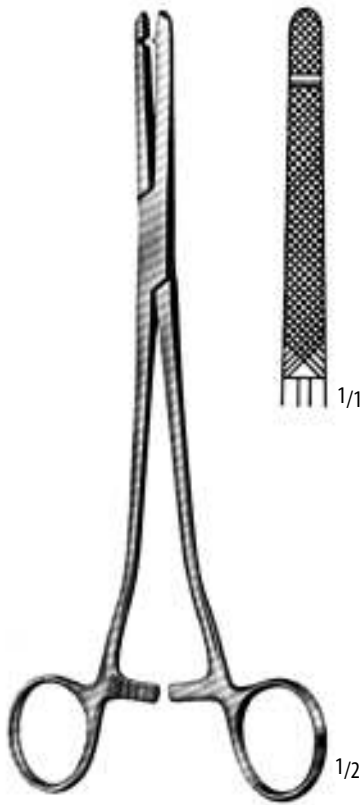

HEANEY - REZAK
HM - 580 - 21
21,0 cm / 8 1/4"

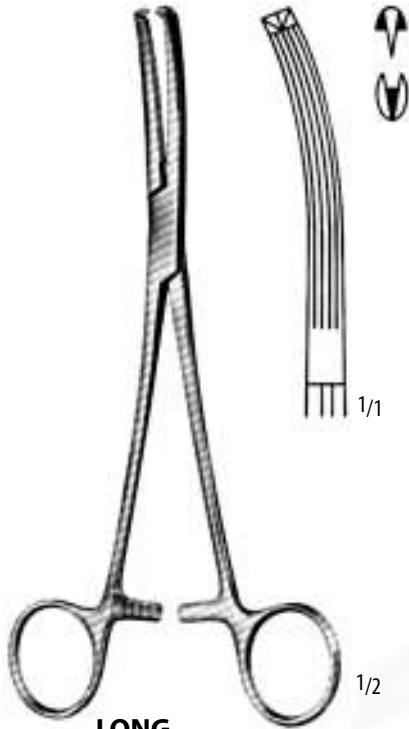

LONG
HM - 581 - 19
19,0 cm / 7 1/4"

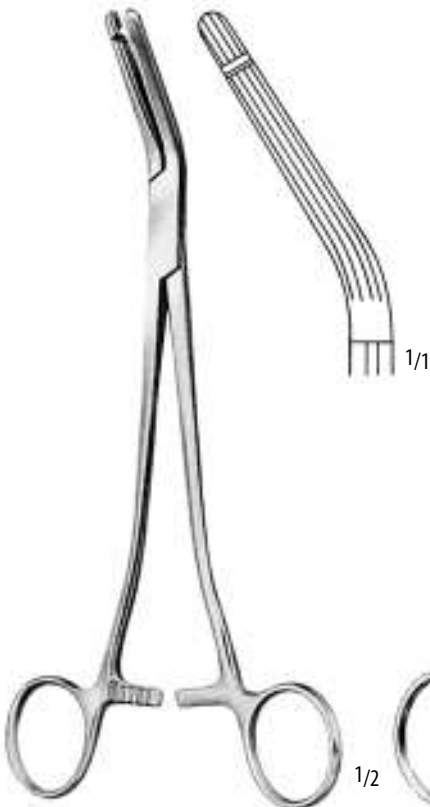

GARLAND
HM - 582 - 21
21,0 cm / 8 1/4"

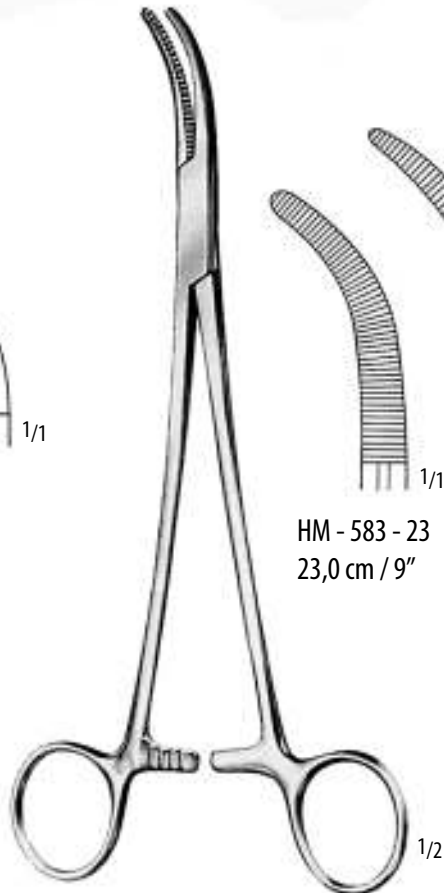

MOYNIHAN

HM - 583 - 23 23,0 cm / 9"
HM - 584 - 24 24,0 cm / 9 1/2"

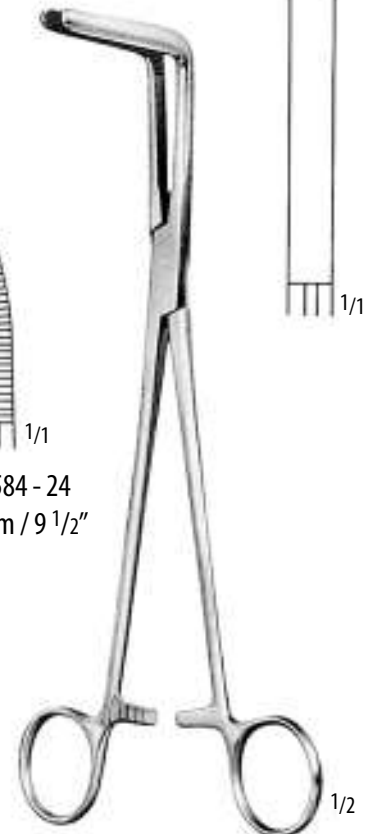

WERTHEM - CULLEN
HM - 585 - 21
21,5 cm / 8 1/2"

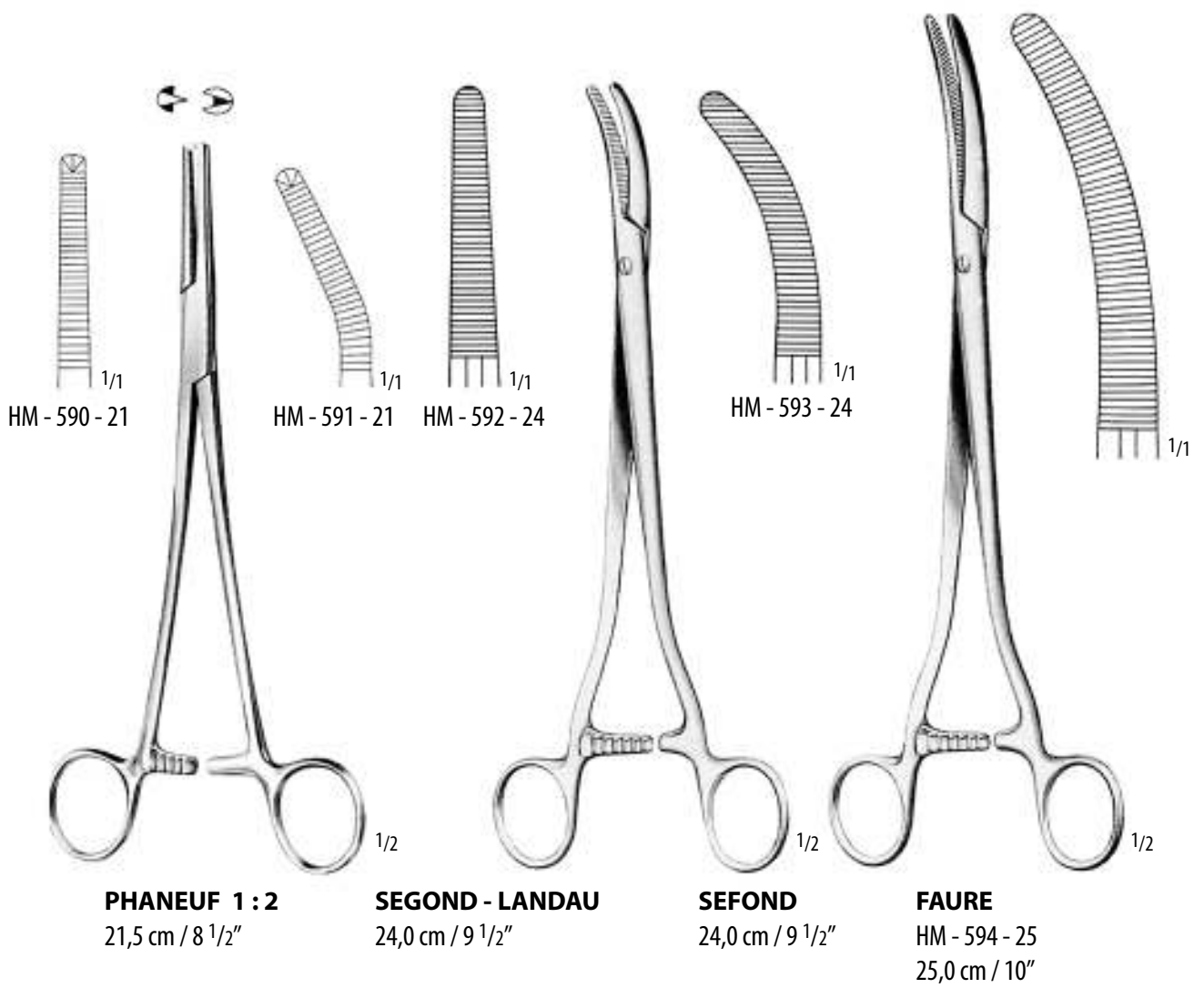

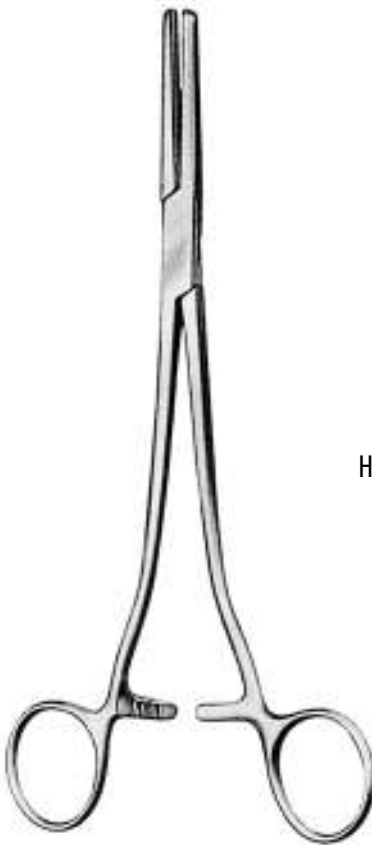

PARAMETRIUM
21,0 cm / 8 1/4"

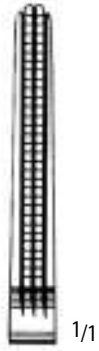

HM - 600 - 00



HM - 600 - 01



HM - 600 - 02



HM - 600 - 03

1/2

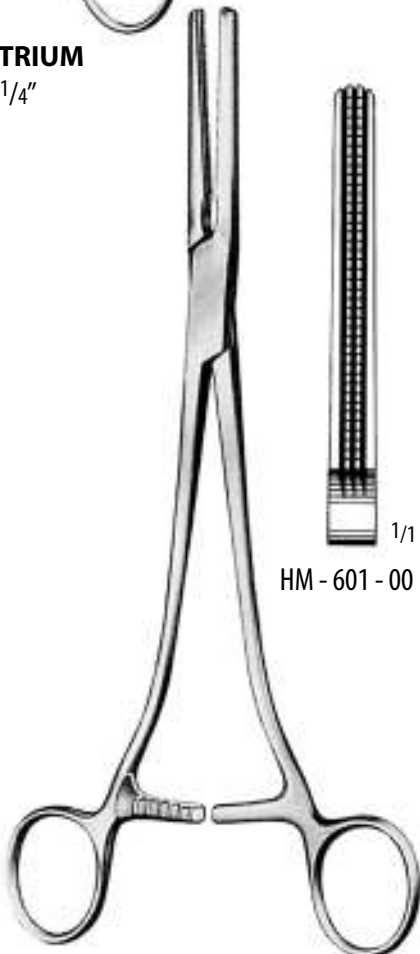

PARAMETRIUM
24,0 cm / 9 1/2"

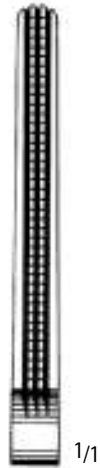

HM - 601 - 00



HM - 601 - 01



HM - 601 - 02



HM - 601 - 03

1/2

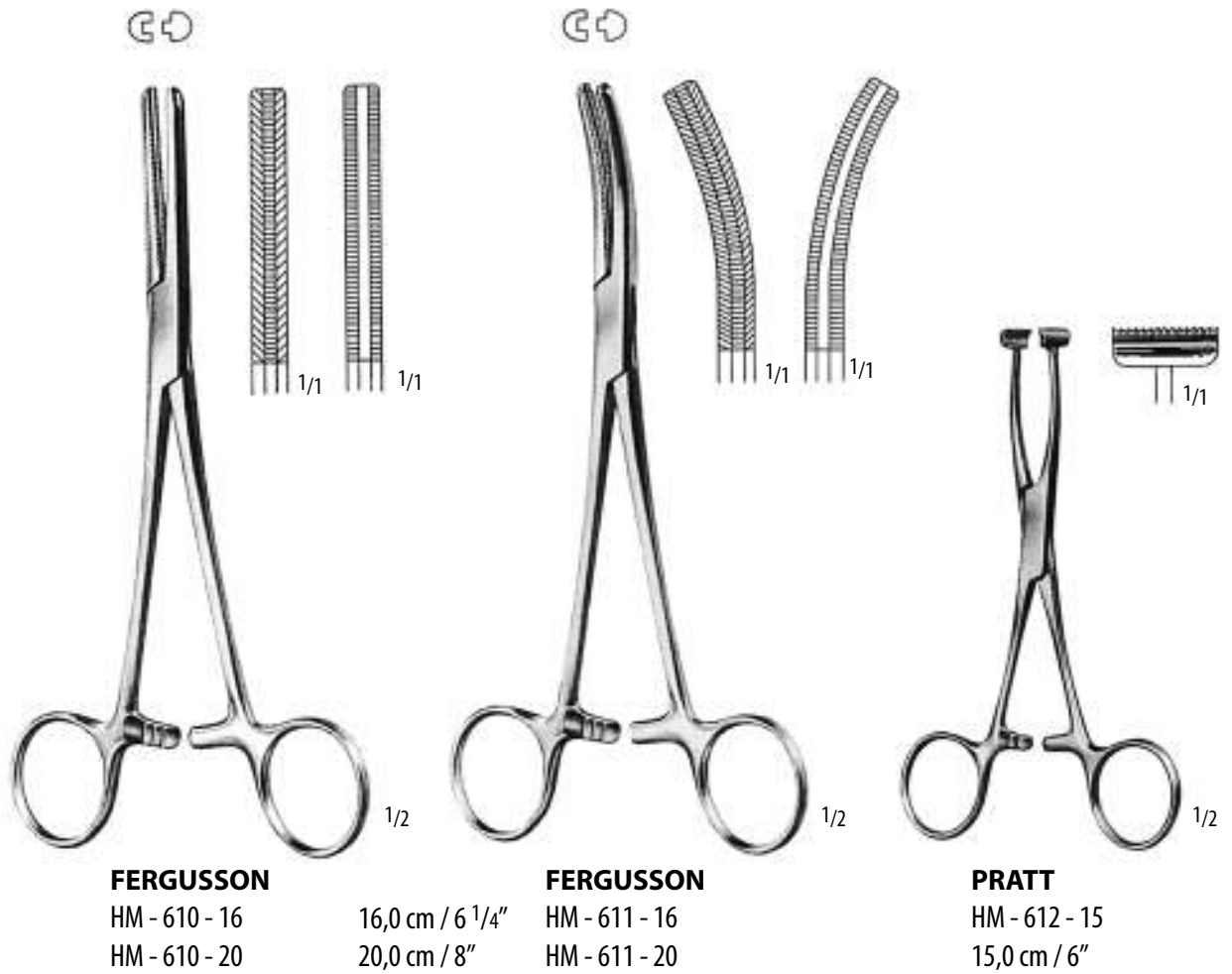

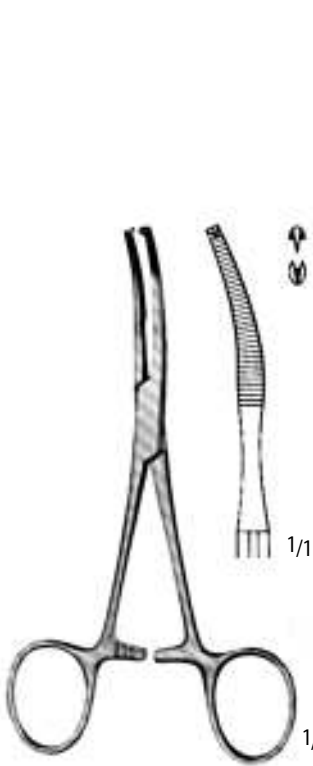

BABY - MIKULICZ 1 : 2
HM - 700 - 14
14,0 cm / 5 1/2"

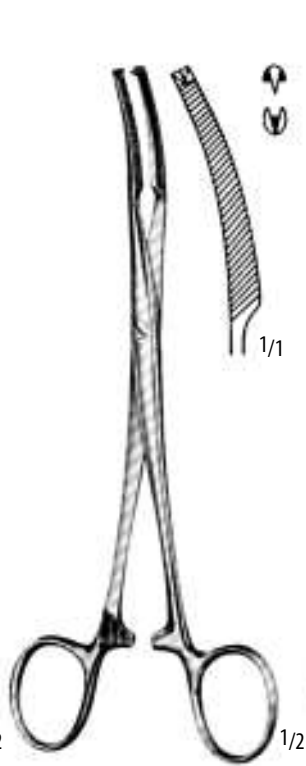

MIKULICZ 1 : 2
HM - 701 - 18
18,0 cm / 7"

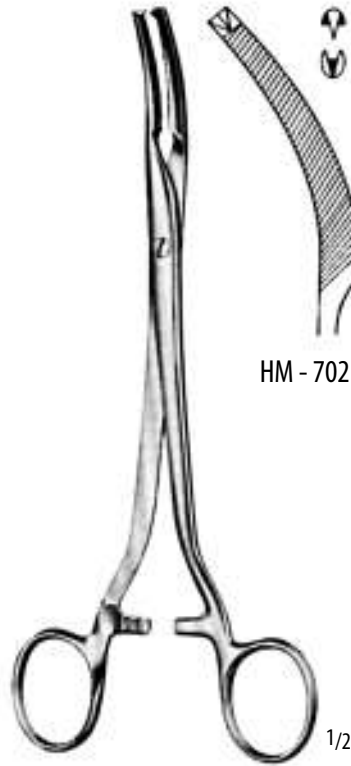

HM - 702 - 20



HM - 703 - 20

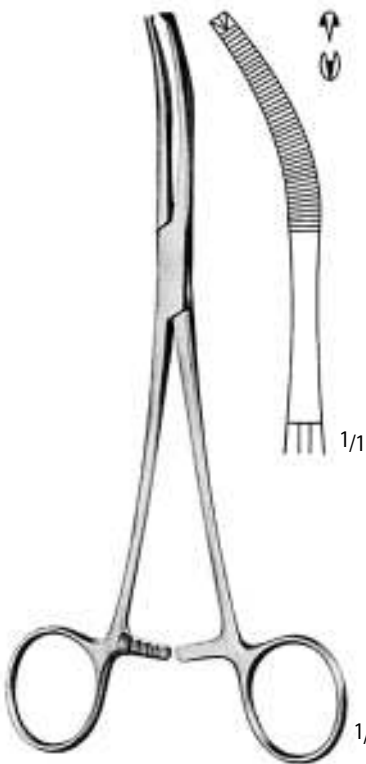

MIKULICZ 1 : 2
HM - 704 - 20
20,0 cm / 8"



MIKULICZ 1 : 2
HM - 705 - 20
20,5 cm / 8"

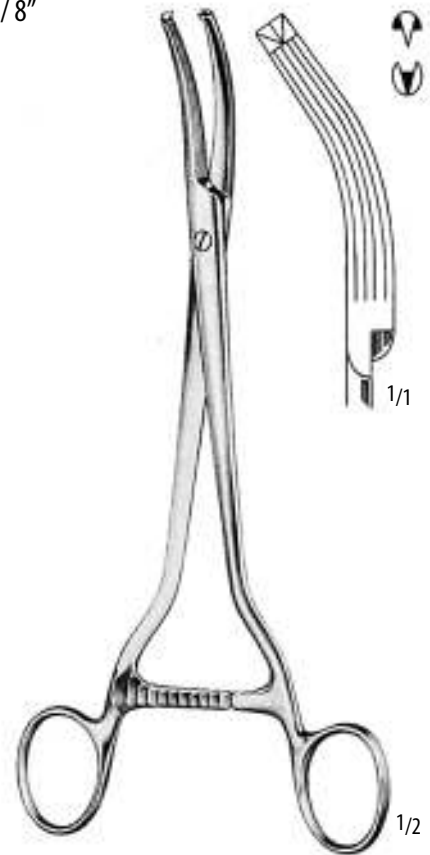

MIKULICZ 1 : 2
HM - 706 - 23
23,0 cm / 9"

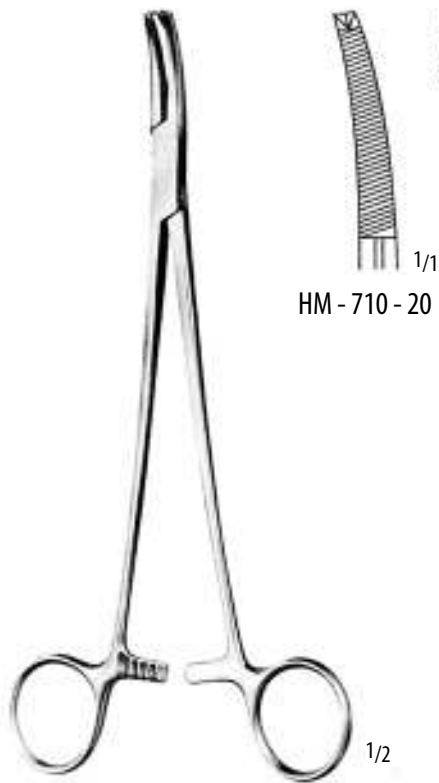

FAURE 1 : 2
20,0 cm / 8"

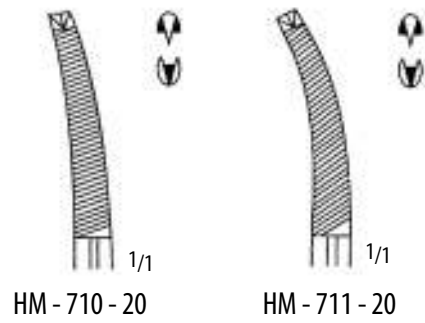

SCHINDLER 1 : 2
HM - 712 - 20
20,0 cm / 8"



1/2

SCHAEDEL

HM - 800 - 09

9,0 cm / 3 1/2"



1/2

JONES

5,0 cm / 2" HM - 820 - 05

9,0 cm / 3 1/2" HM - 820 - 09



1/2

ENGL. MODELL

HM - 822 - 09

9,0 cm / 3 1/2"



1/1

1/2

DOYEN

HM - 830 - 18

18,0 cm / 7"



1/2

BERNHARD

HM - 835 - 16

16,5 cm / 6 1/2"



1/2

LANE

15,0 cm / 6" HM - 840 - 15

18,0 cm / 7" HM - 840 - 18

20,0 cm / 8" HM - 840 - 20



11,0 cm / 4 1/2" HM - 860 - 00



BACKHAUS

- 8,0 cm / 3 1/4" HM - 860 - 08
- 11,0 cm / 4 1/2" HM - 860 - 11
- 13,0 cm / 5" HM - 860 - 13
- 15,0 cm / 6" HM - 860 - 15

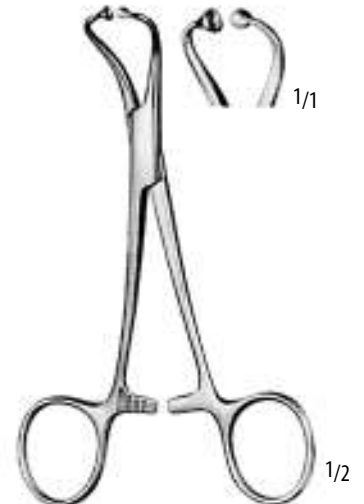

BALL & SOCKET

- HM - 861 - 13
- 13,0 cm / 5"



ROEDER

- 13,0 cm / 5" HM - 880 - 13
- 15,0 cm / 6" HM - 880 - 15



LORNA

- 10,0 cm / 4" HM - 881 - 10
- 13,0 cm / 5" HM - 881 - 13

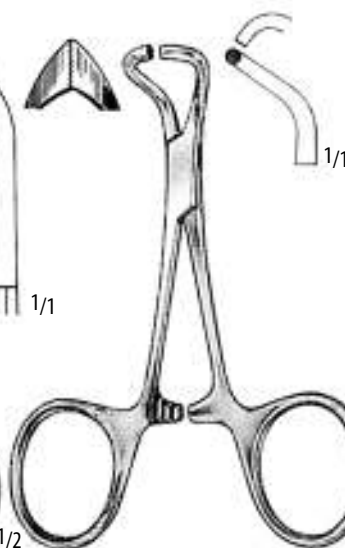

TOHOKU - JAPAN

- 10,0 cm / 4" HM - 882 - 10
- 13,0 cm / 5" HM - 882 - 13

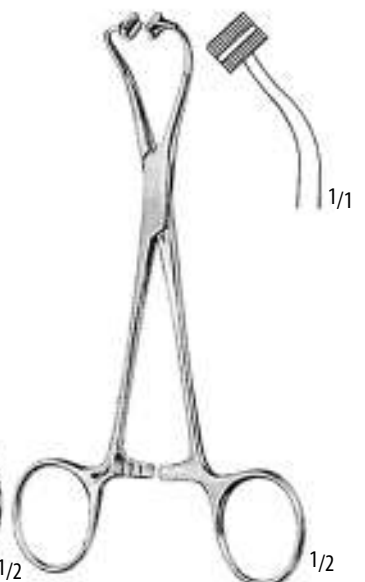

PEERS

- HM - 883 - 14
- 14,5 cm / 5 3/4"

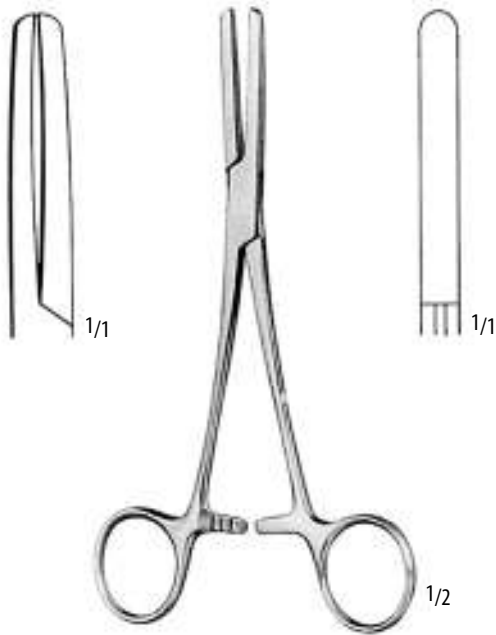

PRESBYTERIAN
 16,5 cm / 6 1/2" HM - 810 - 16
 18,0 cm / 7" HM - 810 - 18

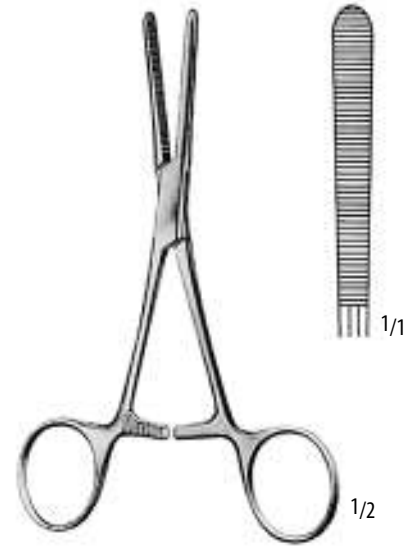

KLINIKUM BERLIN
 HM - 811 - 14
 14,5 cm / 5 3/4"

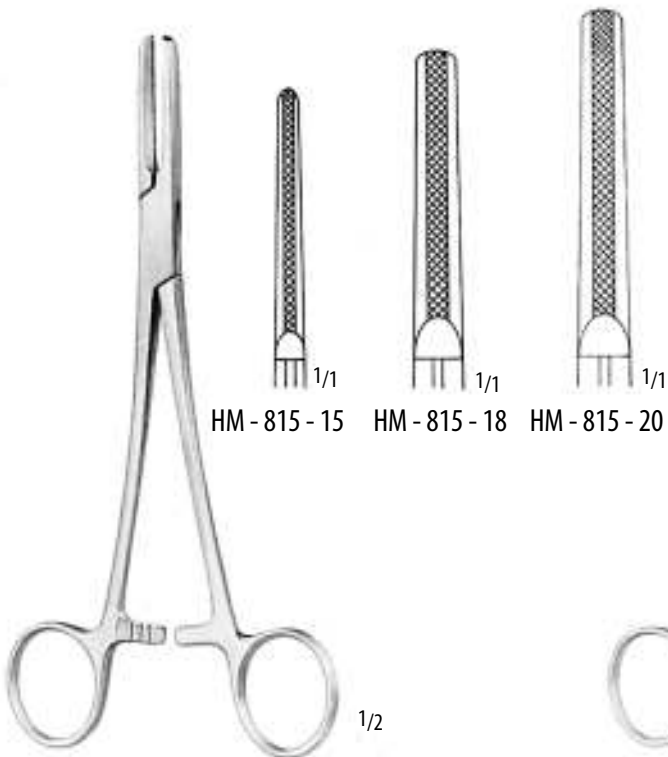

HM - 815 - 15
 HM - 815 - 18
 HM - 815 - 20

15,5 cm / 6 1/4"
 18,0 cm / 7"
 20,0 cm / 8"

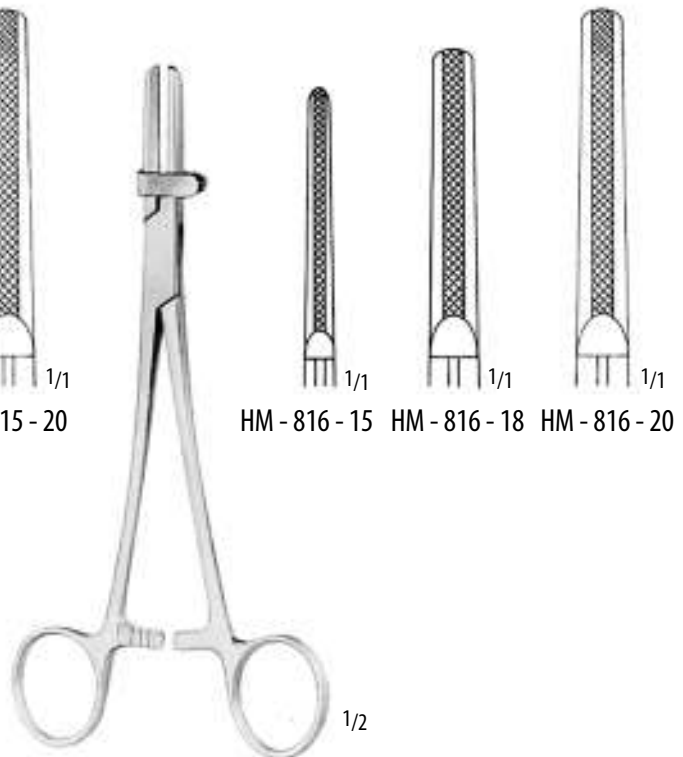

HM - 816 - 15
 HM - 816 - 18
 HM - 816 - 20

HARTMANN
KB - 101 - 08
Ear forceps, serrated jaws, straight

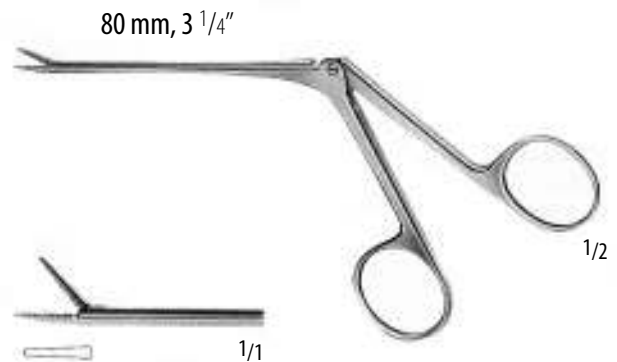

HARTMANN
KB - 102 - 06
Ear forceps, straight, 1x2 teeth



HARTMANN
KB - 103 - 02
Ear forceps, straight



HARTMANN
KB - 104 - 07
Ear forceps, oval, straight



HARTMANN
KB - 105 - 02
Ear forceps, straight



HARTMANN
KB - 106 - 03
Ear forceps, straight



HARTMANN
KB - 107 - 02
Ear forceps, angled up, cup





HARTMANN

KB - 111 - 06 0,8 x 6 mm

Ear forceps, straight



KB - 111 - 06

KB - 111 - 08

KB - 111 - 08 1,8 x 8 mm

Ear forceps, serrated jaws, straight

HARTMANN

KB - 112 - 01 1 mm

Ear forceps, cup-shaped, straight



KB - 112 - 01

KB - 112 - 02

KB - 112 - 02 2 mm

Ear forceps, cup-shaped

HENCKEL

KB - 113 - 01 2,5 mm x 5,0 mm

Ear forceps, flat oval spoon, fenestrated

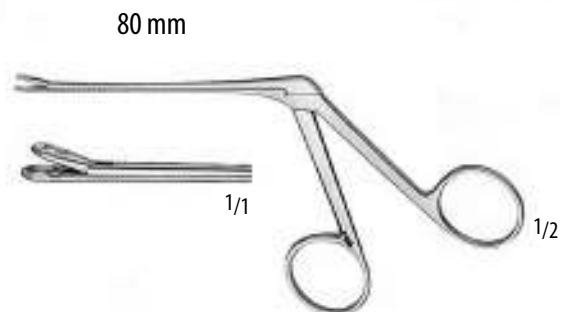

KB - 200 - 01 0,8 x 3,5 mm
Alligator forceps, straight

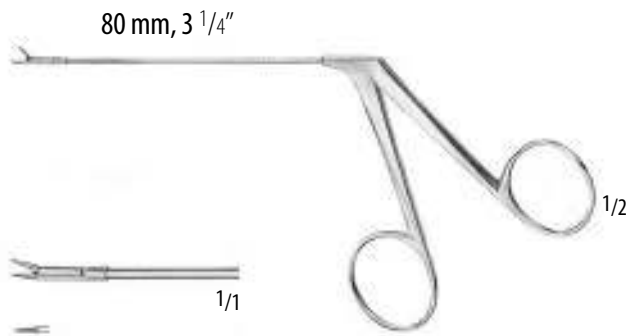

KB - 200 - 02 1,0 x 5,0 mm
Alligator forceps, straight



KB - 200 - 03 1,5 x 6,0 mm
Alligator forceps, straight

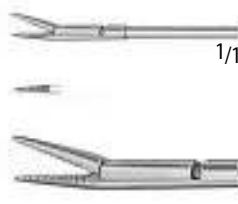

KB - 200 - 65 1,5 x 6,0 mm
Alligator forceps, curved up 65°

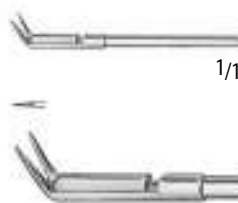

KB - 200 - 45 0,8 x 3,5 mm
Alligator forceps, curved up 45°



KB - 200 - 04 1 x 5 mm
Alligator forceps, curved to left

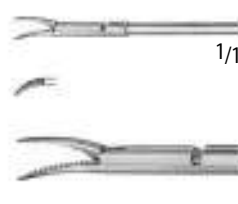

KB - 200 - 05 1 x 5 mm
Alligator forceps, curved to right

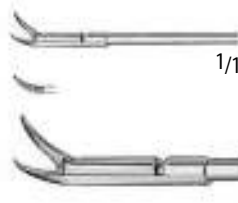

KB - 201 - 01 0,9 x 1,0 mm

Micro cupped forceps, straight, oval jaw

KB - 201 - 02 0,8 x 1,3 mm

Micro cupped forceps, straight, oval jaw

WULLSTEIN

KB - 201 - 03 Ø 1,0 mm

Micro cupped forceps, round jaw

WULLSTEIN

KB - 201 - 04 1,7 x 2,5 mm

Micro cupped forceps, straight, oval jaw

KB - 201 - 05 0,9 x 1,0 mm

Micro cupped forceps, curved up, oval jaw

WULLSTEIN

KB - 201 - 06 0,8 x 1,3 mm

Micro cupped forceps, curved to the left, oval jaw

WULLSTEIN

KB - 201 - 07 0,8 x 1,3 mm

Micro cupped forceps, curved to the right, oval jaw

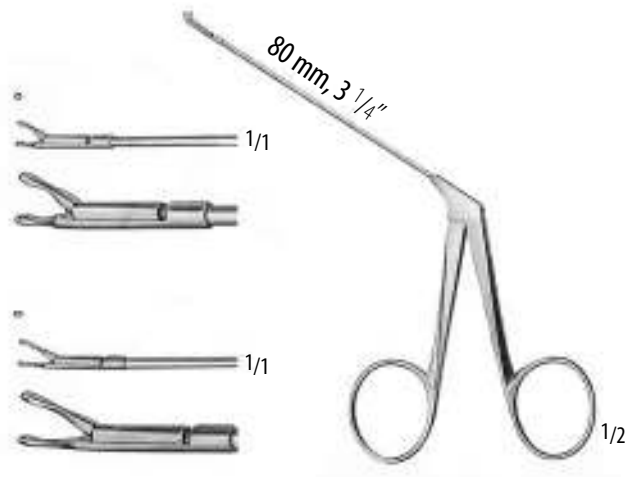

KB - 202 - 01
Micro scissors, straight, sharp / sharp

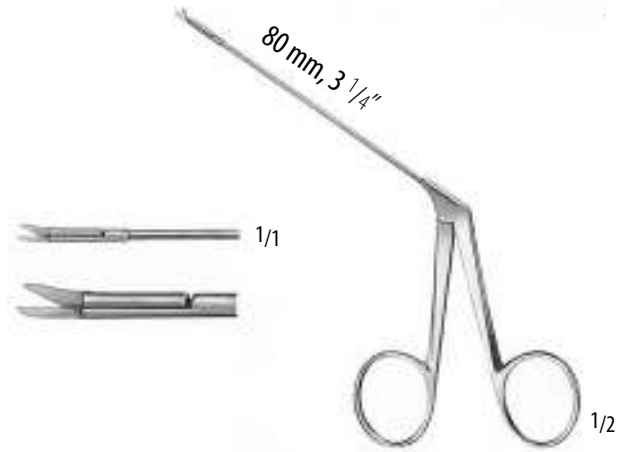

BELLUCCI
 KB - 202 - 02
Micro scissors, curved up, blunt / blunt



BELLUCCI
 KB - 202 - 03
Micro scissors, curved to the left, sharp / sharp



BELLUCCI
 KB - 202 - 04
Micro scissors, curved to the right, sharp / sharp



BELLUCCI
 KB - 202 - 05
Micro scissors, horizontal cutting



HARTMANN - HALLE

KB - 250 - 15

KB - 251 - 15

KB - 252 - 15

Nasal specula, aseptic joint

150 mm, 6"

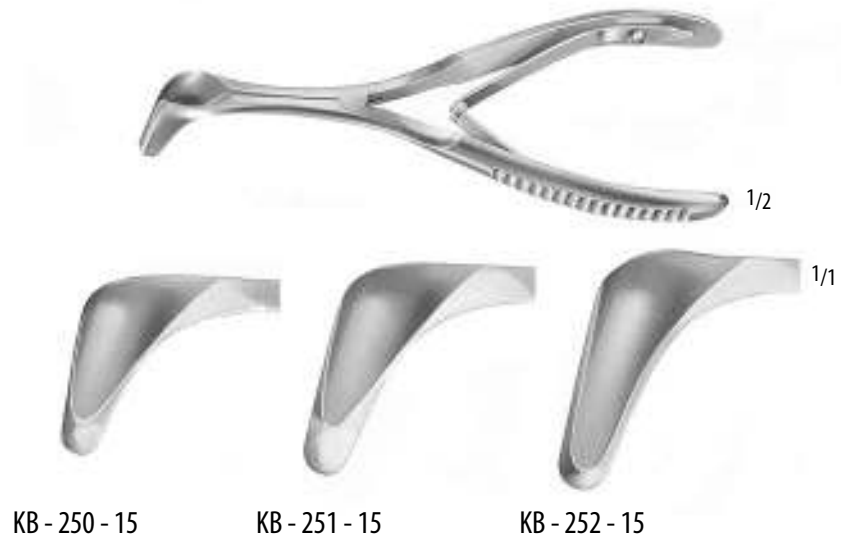

HARTMANN - HALLE

KB - 250 - 16

KB - 251 - 16

KB - 252 - 16

Nasal specula, screw joint

160 mm, 6"

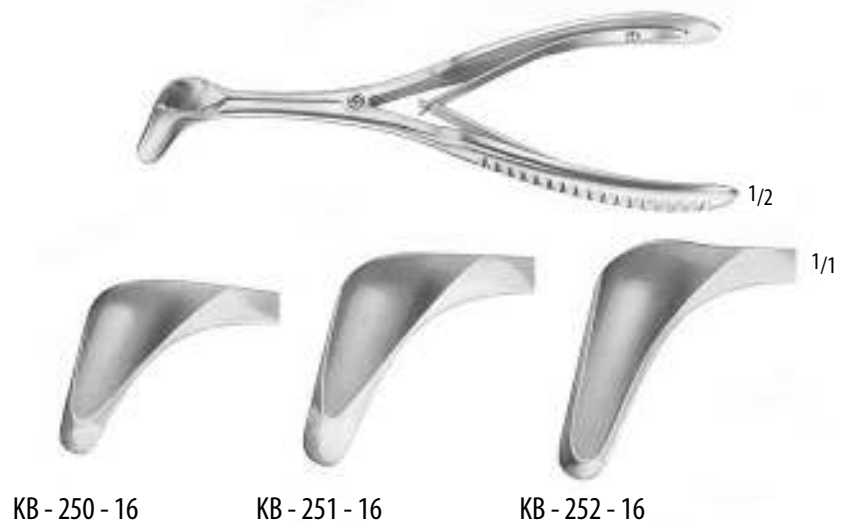

TIECK - HALLE

KB - 250 - 13

KB - 251 - 13

Nasal specula, screw joint, for use in infants, curved sidwards

135 mm, 5 1/4"

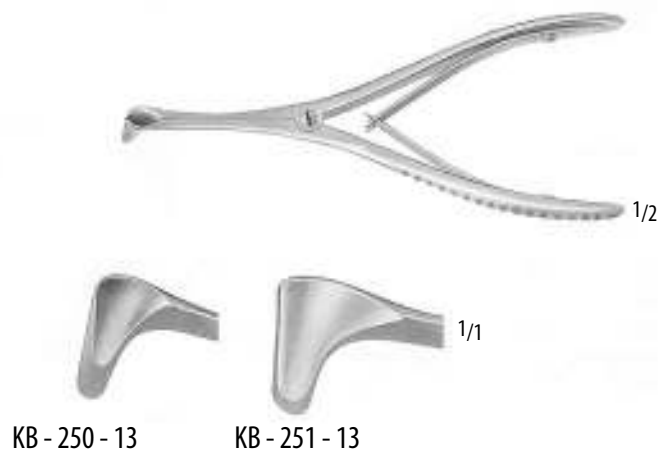

BECKMANN

KB - 255 - 14

Nasal specula, screw joint, for use in infants, curved sideways

140 mm, 5 1/2"

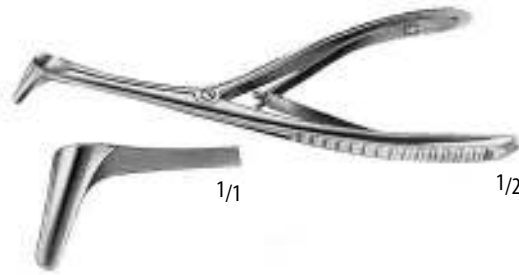

BECKMANN

KB - 256 - 15

Nasal specula, screw joint curved sideways

150 mm, 6"

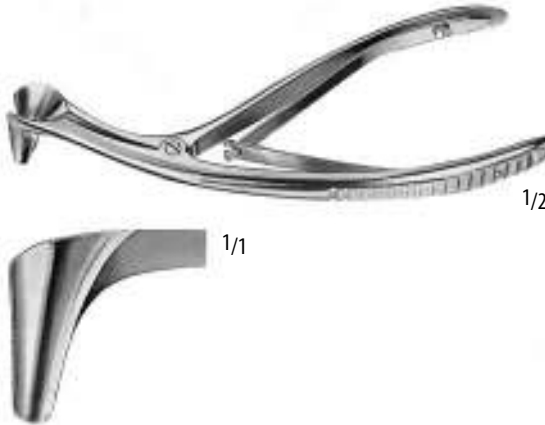

HARTMANN

KB - 257 - 16

KB - 258 - 16

KB - 259 - 16

Nasal specula, screw joint

160 mm, 6 1/4"

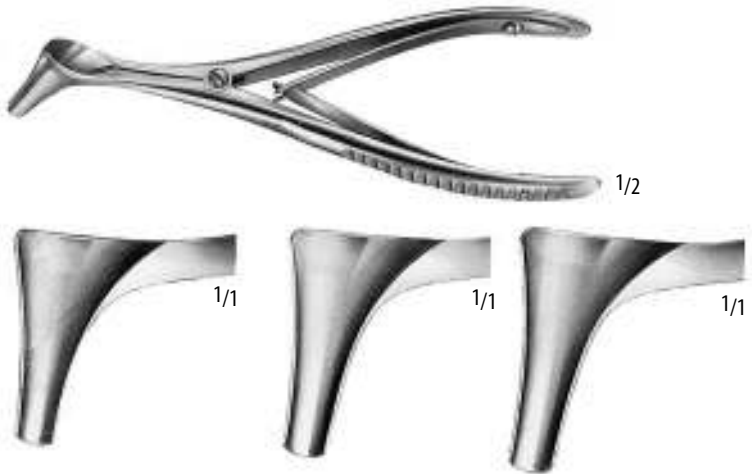

KB - 257 - 16

KB - 258 - 16

KB - 259 - 16

WIENER MODELL

KB - 259 - 14

Nasal specula, screw joint, small, light pattern

140 mm, 5 1/2"

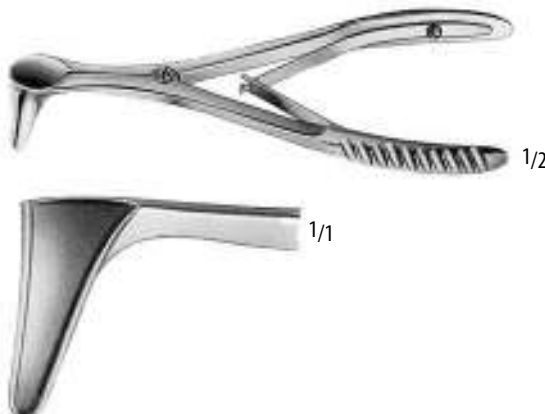

KILLIAN

- KB - 260 - 01 Fig. 1 36 x 7 mm
- KB - 260 - 02 Fig. 2 56 x 7 mm
- KB - 260 - 03 Fig. 3 75 x 7 mm
- KB - 260 - 04 Fig. 4 90 x 7 mm

Septum specula, aseptic joint

145 mm, 5 3/4"

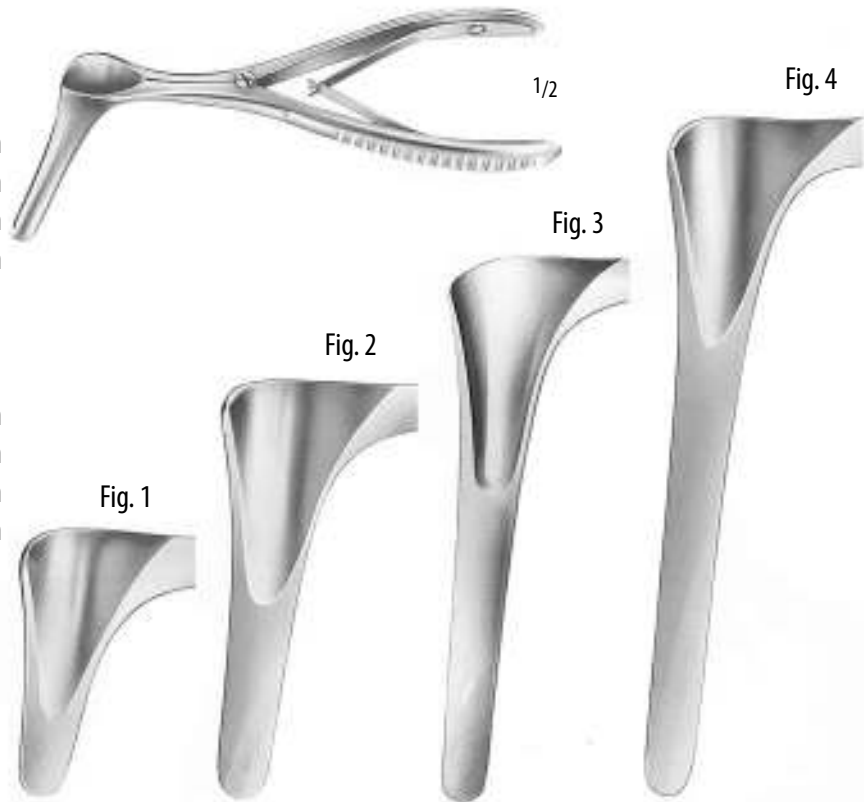

- KB - 261 - 01 Fig. 1 36 x 7 mm
- KB - 261 - 02 Fig. 2 56 x 7 mm
- KB - 261 - 03 Fig. 3 75 x 7 mm
- KB - 261 - 04 Fig. 4 90 x 7 mm

Septum specula, aseptic joint

140 mm, 5 1/2"

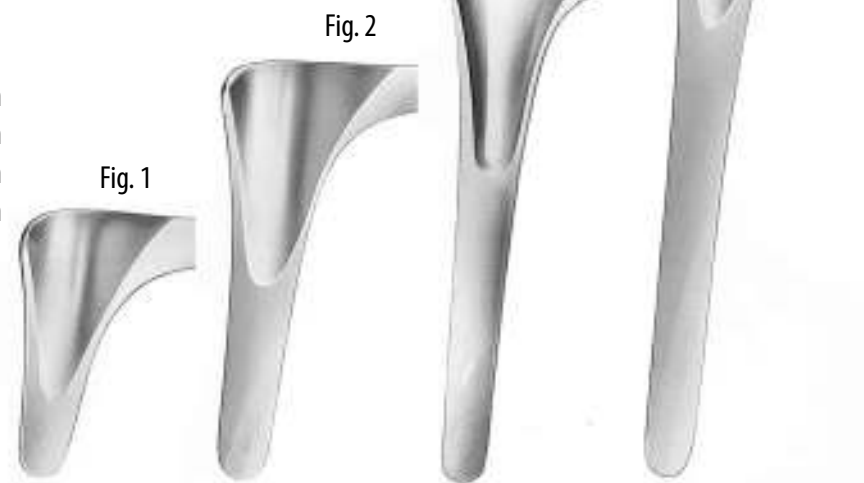

COTTLE

- KB - 262 - 01 Fig. 1 20 mm
- KB - 262 - 02 Fig. 2 38 mm
- KB - 262 - 03 Fig. 3 41 mm
- KB - 262 - 04 Fig. 4 60 mm
- KB - 262 - 05 Fig. 5 76 mm
- KB - 262 - 06 Fig. 6 90 mm

Septum specula, aseptic joint, set-crew, with extra thin blades

135 mm, 5 1/4"

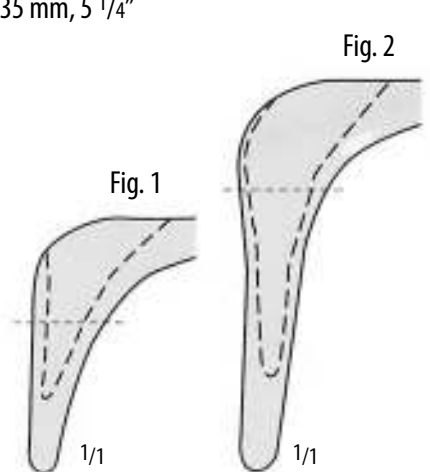
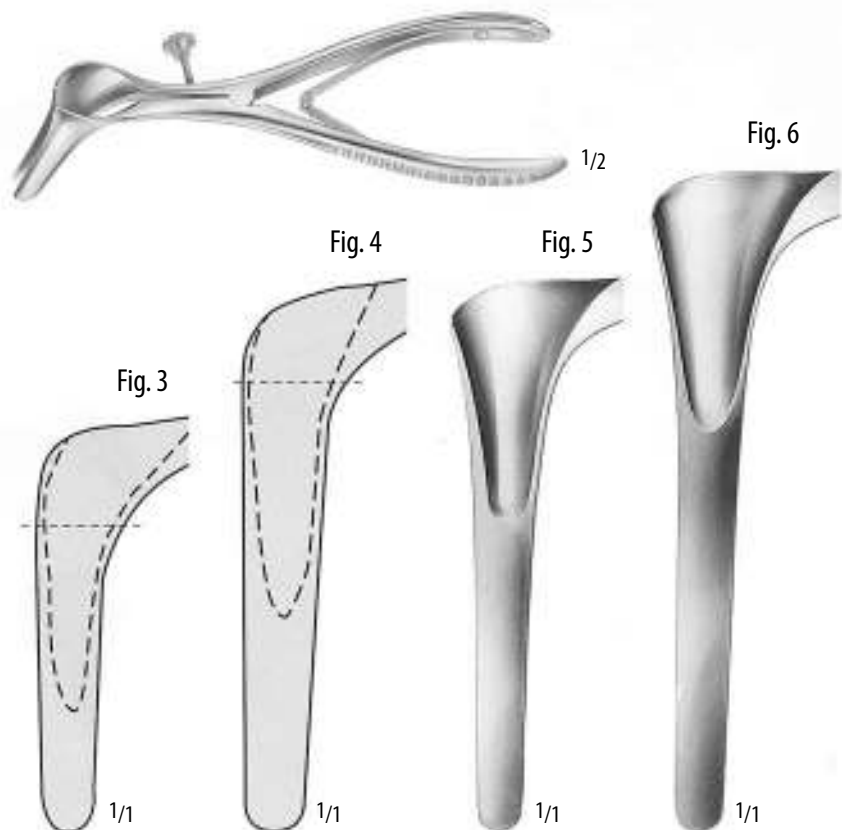

KRAUSE

KB - 300 - 00

Nasal polypus, snare, angled

250 mm, 10"

KB - 300 - 01

Tube only

KB - 300 - 02

Wire guide only



1/2

KRAUSE - VOSS

KB - 301 - 00

**Nasal polypus, snare, angled, complete with tube
vertical KB - 301 - 01, tube horizontal KB - 301 - 02**

250 mm, 10"

KB - 301 - 01

Tube with wire guide only, vertical

KB - 301 - 02

Tube with wire guide only, horizontal

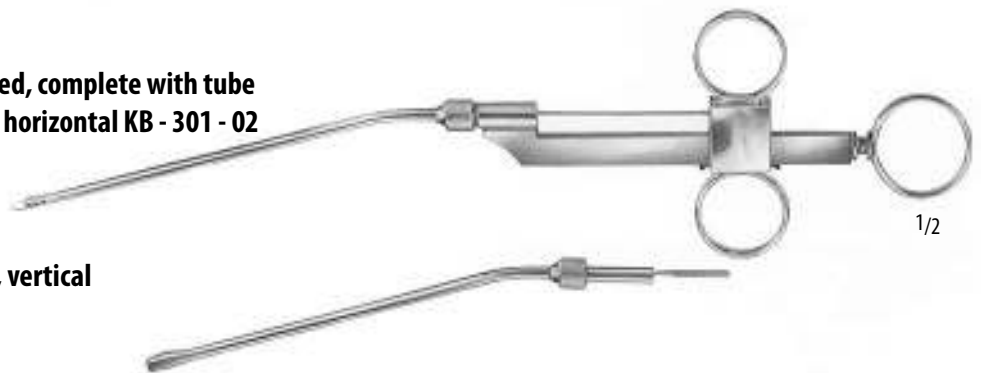

1/2

WILDE

KB - 302 - 00

Nasal polypus, snare, beyond shaped

250 mm, 10"



1/2

KB - 303 - 00

**Wire loops for nasal snares,
sales unit : PH = Package of 100 pieces**

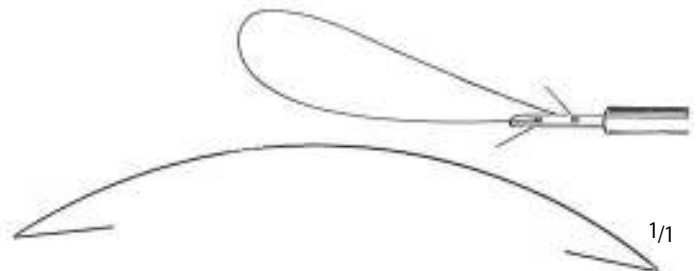

1/1

KB - 304 - 00

Snare wire in coils of 10 metres



HEYMANN
KB - 310 - 19
Nasal scissors
190 mm, 7 1/2"

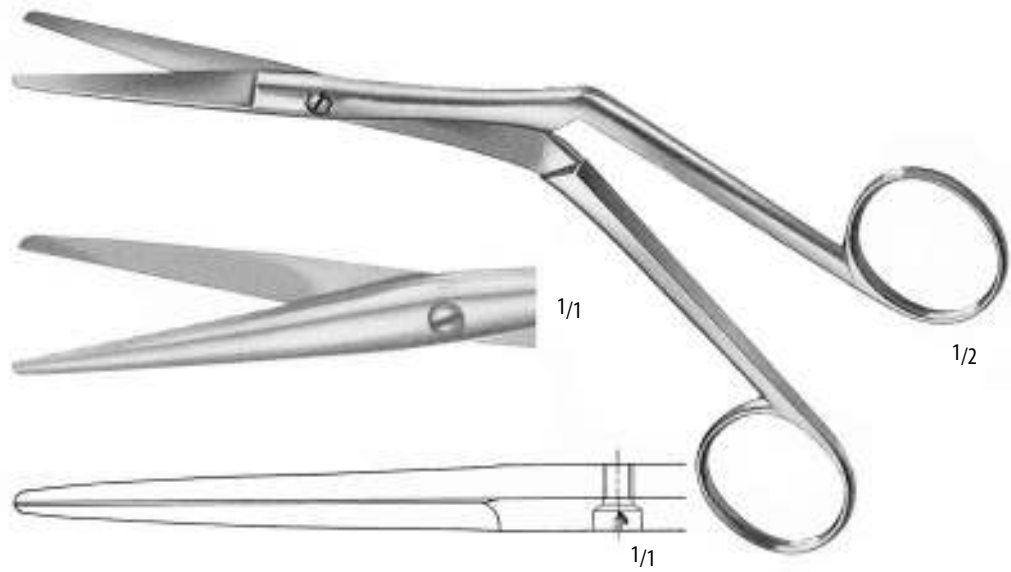

KIRSTEIN
KB - 310 - 17
Nasal scissors, blades serrated
175 mm, 7"

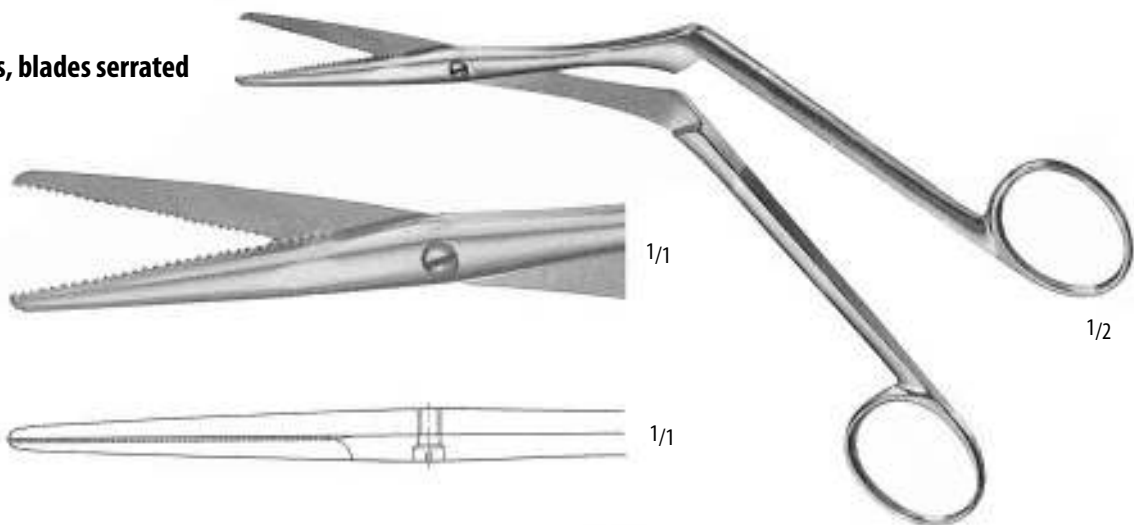

OLIVECRONA
KB - 310 - 22
Nasal scissors
225 mm, 9"

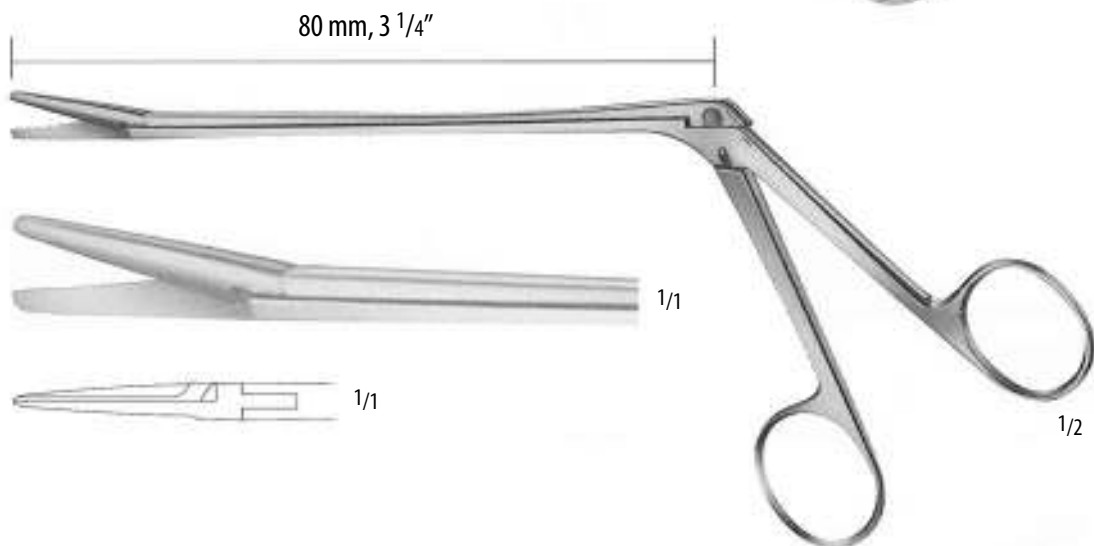

FREER

KB - 350 - 15

Mucous knife

155 mm, 6"



BRUNINGS

KB - 350 - 13

Septatome

155 mm, 6 1/4"



HALLE

KB - 350 - 18 3,3 mm

Elevator, blunt

180 mm, 7"



FREER

KB - 350 - 19 4 mm

Respatory, sharp

190 mm, 7 1/2"



FREER

KB - 351 - 19 4 mm

Respatory, sharp

190 mm, 7 1/2"



FREER

KB - 352 - 19 4 mm

Elevator, curved to the side

190 mm, 7 1/2"



FREER

KB - 352 - 17

Respatory, sharp

175 mm, 7"



FREER

KB - 353 - 18

Elevator, sharp / blunt

185 mm, 7 1/4"

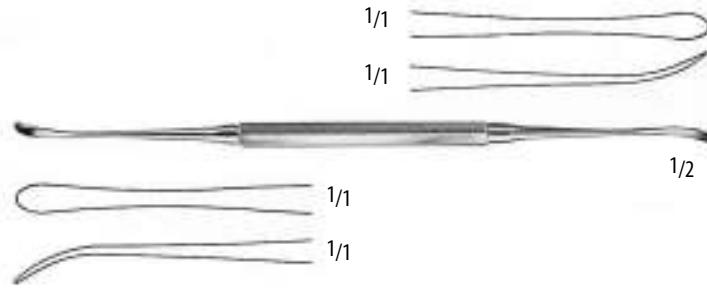

FREER - YASARGIL

KB - 354 - 18

Dissector, sharp

185 mm, 7 1/4"

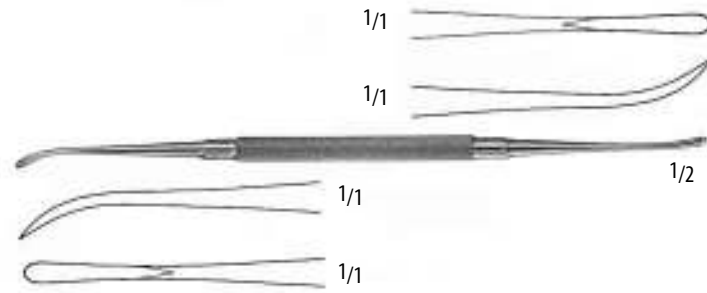

KILLIAN

KB - 355 - 18

Elevator, sharp / blunt

180 mm, 7"

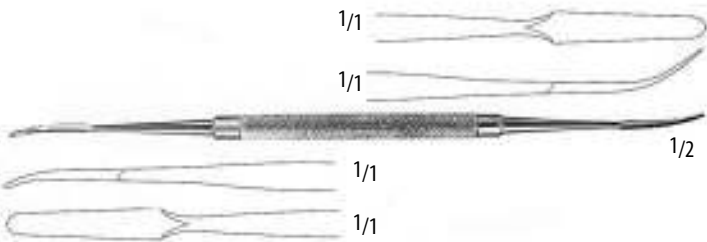

HILL

KB - 356 - 22

Elevator, semi-sharp / blunt

220 mm, 8 3/4"



MACDONALD

KB - 357 - 19

Dissector, blunt | blunt

190 mm, 7 1/2"



WATSON - CHEYNE

KB - 358 - 13

Raspatory

130 mm, 5 1/8"

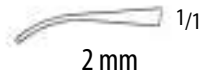

KB - 358 - 19

Raspatory

190 mm, 7 1/2"

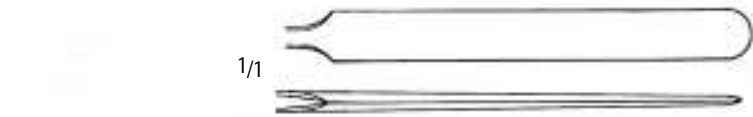
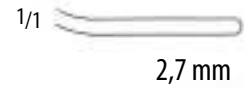
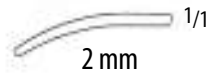

KILLIAN

KB - 359 - 18

Elevator, sharp / blunt

185 mm, 7 1/4"

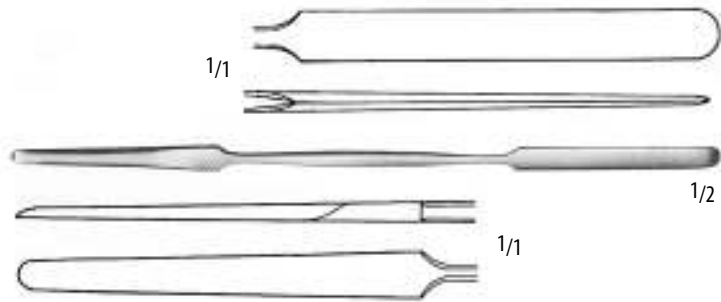

NEGUS

KB - 360 - 21 6 mm

Suction dissector

210 mm, 8 1/4"



Olive
Ø 6 mm

NEGUS

KB - 361 - 21

Suction dissector, insulated

210 mm, 8 1/4"



Olive
Ø 6 mm
04 mm

HOWARTH

KB - 362 - 21

Elevator

215 mm, 8 1/4"

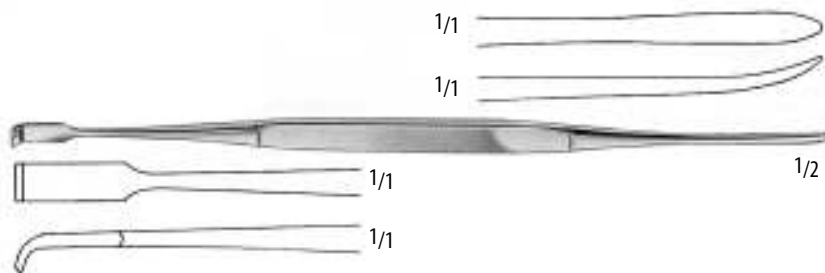

FREER

KB - 363 - 18

Separator and elevator

180 mm, 7"

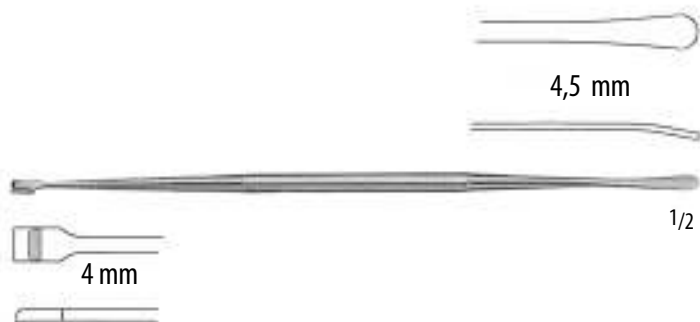

4,5 mm

ST CLAIR THOMPSON

KB - 365 - 16 sharp

KB - 366 - 16 blunt

Raspatory, periosteal elevator

160 mm, 6 1/4"



FREER

KB - 367 - 16

Septum chisel, straight

160 mm, 6 1/4"

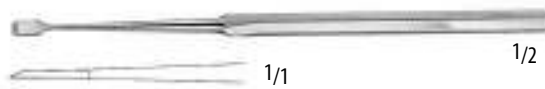

FREER

KB - 368 - 16

Septum chisel, curved

160 mm, 6 1/4"

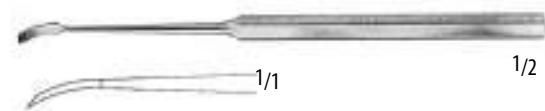

FRANCIS ALAE - NASI

- KB - 400 - 01 11 mm x 15 mm
- KB - 400 - 02 12 mm x 16 mm
- KB - 400 - 03 13 mm x 17 mm
- KB - 400 - 04 14 mm x 18 mm
- KB - 400 - 05 15 mm x 19 mm

Nasal dilators, silver



BALLENGER

- KB - 410 - 01 4 mm x 3 mm
- Swivel knife, straight**
203 mm, 8"



BALLENGER

- KB - 411 - 03 4 mm x 3 mm
 - KB - 411 - 04 5 mm x 4 mm
 - KB - 411 - 05 6 mm x 5 mm
- Swivel knife, bayoned shaped**
210 mm, 8 1/4"

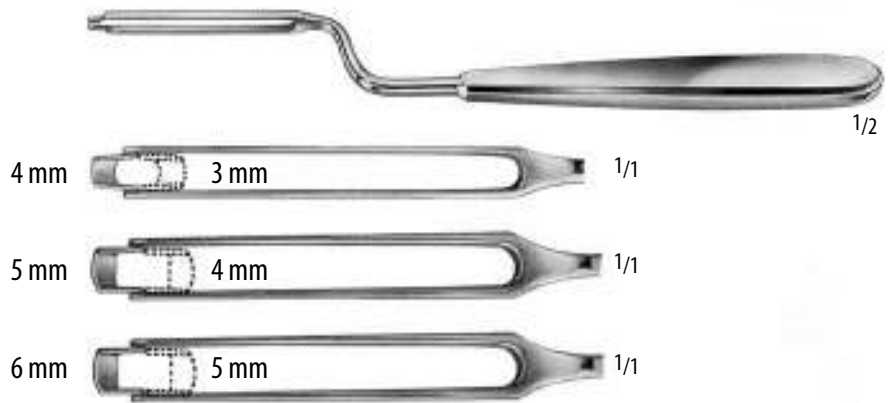

JANSEN - MIDDLETON

- KB - 415 - 20
- Nasal forceps, spoon-shaped, biting**
200 mm, 8"



JANSEN - MIDDLETON

- KB - 416 - 21
- Nasal forceps, through cutting**
210 mm, 8 1/4"



FREER

KB - 420 - 15

Septum gouge, straight, round cutting edge

150 mm, 6"



BALLENGER

KB - 421 - 15

Septum gouge, with notch and cutting edge

155 mm, 6"



KILLIAN - CLAUS

KB - 422 - 17

Septum gouge, with notch, bayonet shaped

170 mm, 6 3/4"



KILLIAN - CLAUS

KB - 423 - 17

Septum gouge, round cutting edge, bayonet shaped

170 mm, 6 3/4"

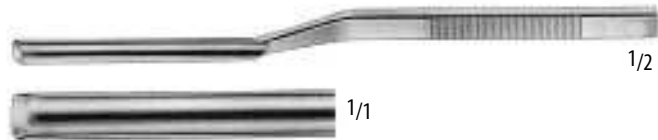

KB - 900 - 18

Mallet head with interchangeable plastic disks

185 mm, 7 1/4"



KB - 901 - 18

Pair of spare disks for mallet KB - 900 - 18

185 mm, 7 1/4"

KB - 902 - 18

Mallet 1 plain flat, 1 convex

185 mm, 7 1/4"



WEIL - BLAKESLEY

- KB - 450 - 01 3,0 mm
- KB - 450 - 02 3,6 mm
- KB - 450 - 03 4,2 mm
- KB - 450 - 04 4,8 mm
- KB - 450 - 05 5,6 mm

Ethmoidal forceps, straight, oval pointed, cup-shaped fenestrated jaws

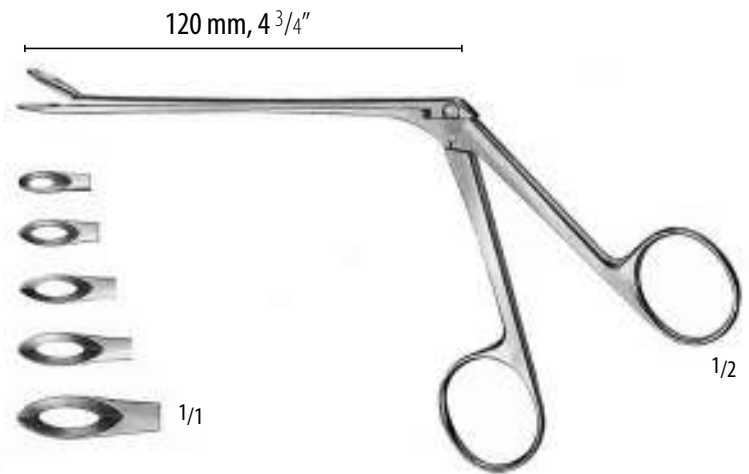

WEIL - BLAKESLEY

- KB - 451 - 01 3,6 mm
- KB - 451 - 02 4,2 mm
- KB - 451 - 03 4,8 mm

Ethmoidal forceps, upwards curved, oval pointed, cup-shaped fenestrated jaws

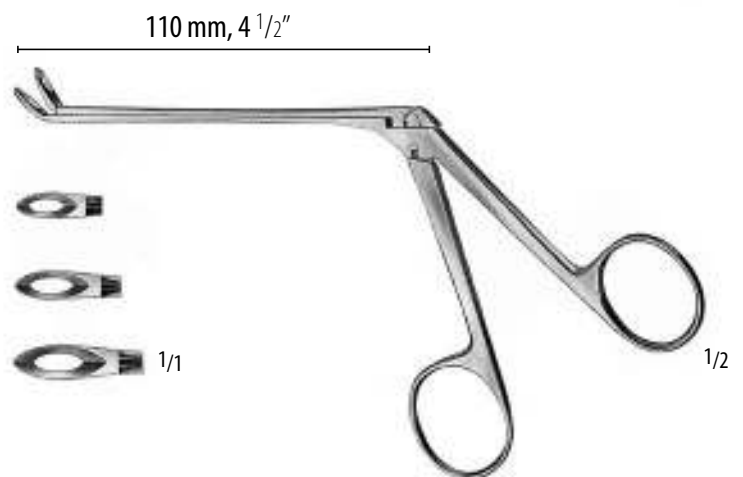

TILLEY HENCKEL

- KB - 452 - 01 6,5 mm

Ethmoidal forceps, straight, shaft graduated

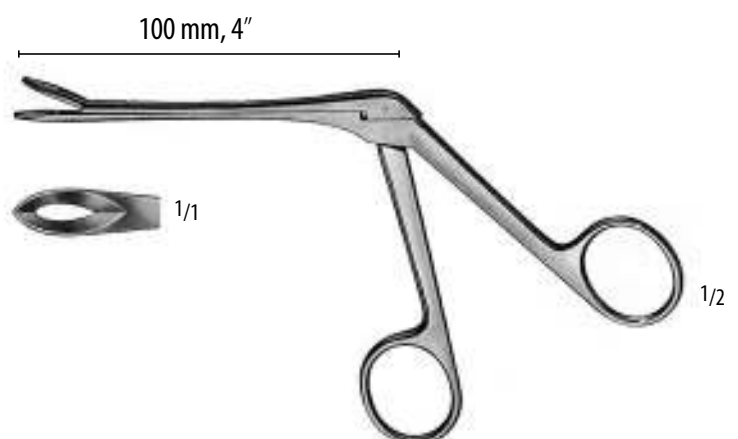

PENNINGTON

KB - 460 - 21

Raspatory

210 mm, 8 1/4"



COTTLE

KB - 460 - 20

Elevator, double-ended, graduated

200 mm, 8"



COTTLE

KB - 461 - 20

Elevator, double-ended, graduated

200 mm, 8"



COTTLE

KB - 462 - 20

Elevator, double-ended, for tunneling

200 mm, 8"

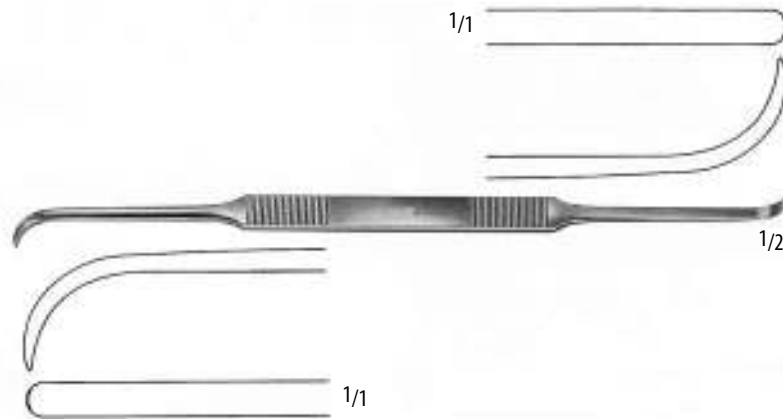

COTTLE

KB - 463 - 20

Periosteal elevator, curved, sharp

200 mm, 7 3/4"

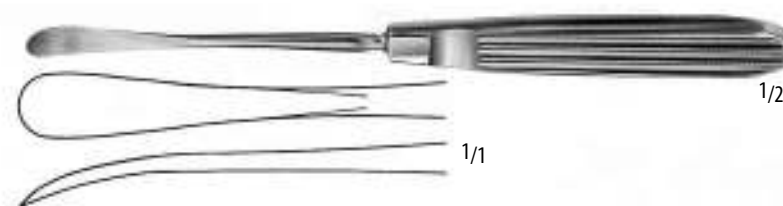

HALLE

KB - 464 - 18

Elevator, blunt

180 mm, 7"



FREER

KB - 465 - 18

Raspatory, sharp

180 mm, 7 1/2"



FREER

KB - 465 - 19

Elevator, blunt

190 mm, 7 1/2"



FREER

KB - 466 - 18

Knife, curved to side

185 mm, 7 1/4"



FREER

KB - 466 - 19

Elevator, sharp

185 mm, 7"



FREER

KB - 467 - 18

Elevator, sharp / blunt

185 mm, 7 1/4"

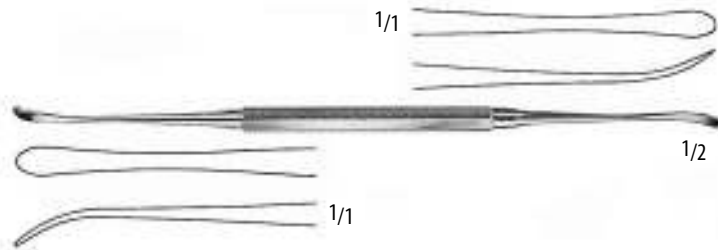

FREER - YASARGIL

KB - 468 - 18

Dissector, sharp

185 mm, 7 1/4"

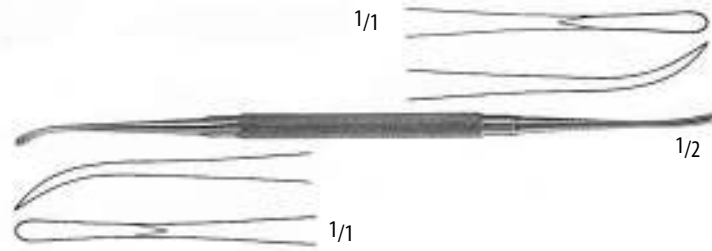

FREER - YASARGIL

KB - 469 - 18

Elevator, sharp / blunt

185 mm, 7"

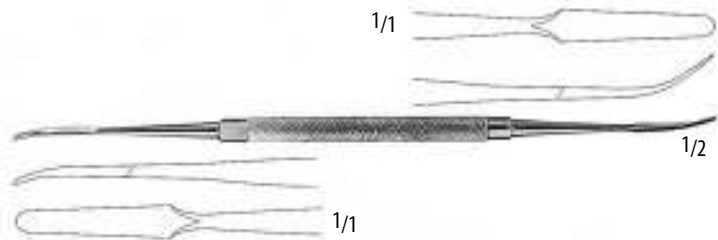

HOWARTH

KB - 470 - 21

Elevator

215 mm, 8 1/2"

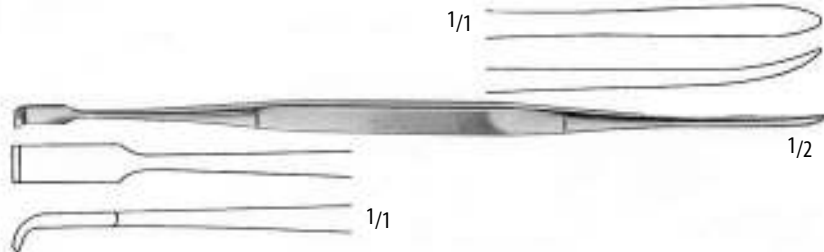

KILLIAN

KB - 471 - 18

Elevator, sharp / blunt

185 mm, 7 1/4"

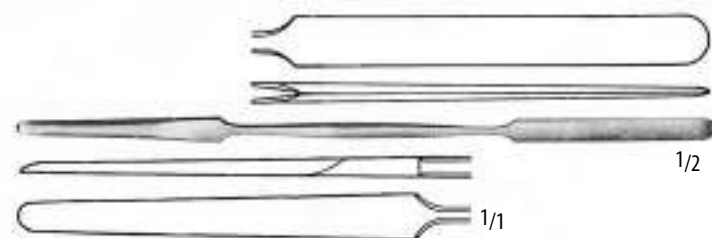

FOMON

KB - 480 - 14

Alar retractor, 2 prongs, blunt | blunt

145 mm, 5 3/4"

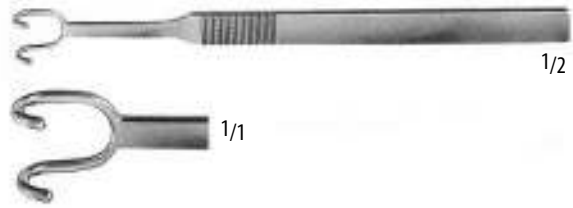

COTTLE

KB - 481 - 14

Alar retractor, sharp prong on right when instrument lies with prongs up

145 mm, 5 3/4"

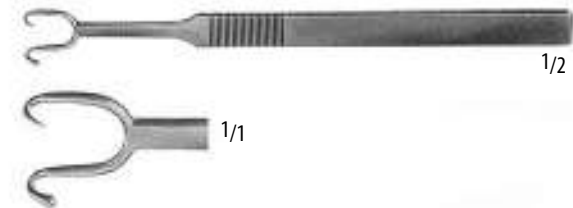

COTTLE

KB - 482 - 14

Alar retractor, sharp prong on left when instrument lies with prongs up

145 mm, 5 3/4"

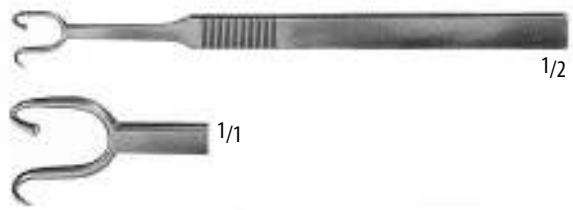

KILNER

KB - 483 - 08

Alar retractor, 2 sharp prongs

80 mm, 3 1/4"



CONVERSE

KB - 484 - 12

Alar retractor, double-ended 2 blunt prongs

120 mm, 4 3/4"

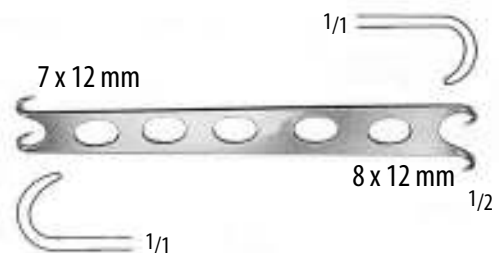

COTTLE

KB - 485 - 20

Alar retractor, with saw and knife guide, blunt

200 mm, 8"

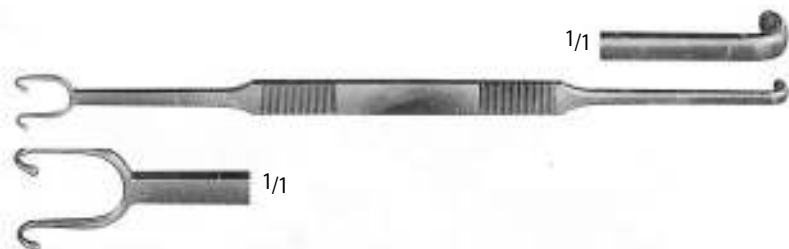

COTTLE

KB - 490 - 18

**Fishtail osteotomes with protected ends,
double gaured**

180 mm, 7"



COTTLE

KB - 491 - 04 4 mm

KB - 491 - 06 6 mm

KB - 491 - 08 8 mm

KB - 491 - 10 10 mm

KB - 491 - 12 12 mm

Osteotomes with depth markings

180 mm, 7"

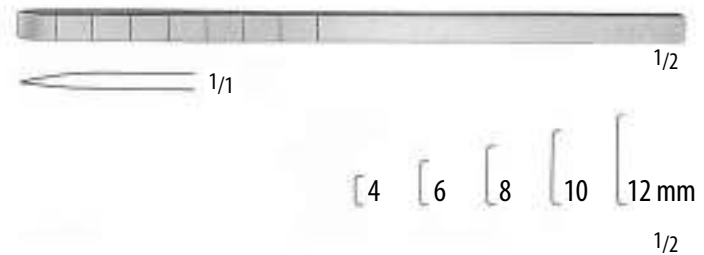

COTTLE

KB - 492 - 04 4 mm

KB - 492 - 07 7 mm

KB - 492 - 09 9 mm

KB - 492 - 12 12 mm

Chisel with depth markings

180 mm, 7"

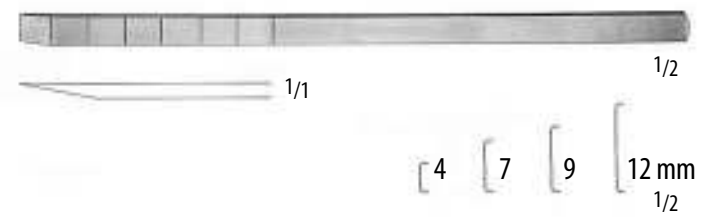

COTTLE

KB - 493 - 06 6 mm

**Osteotome, curved, for transverse
osteotomies**

180 mm, 7"



WALTER

KB - 494 - 03 3,0 mm

KB - 494 - 04 3,0 mm

Chisel with notch, double guarded

180 mm, 7"

KB - 494 - 03

KB - 494 - 04

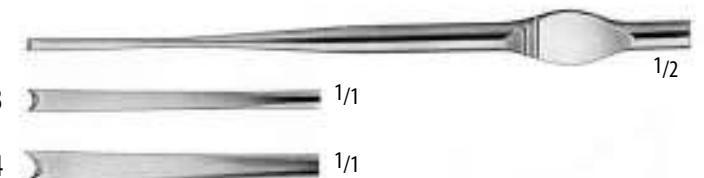

MASING

KB - 495 - 01 curved left

KB - 495 - 02 curved right

KB - 495 - 03 straight

Chisel with notch, double guarded

175 mm, 7"

KB - 495 - 01

KB - 495 - 02

KB - 495 - 03



KB - 496 - 04 4 mm

KB - 496 - 06 6 mm

KB - 496 - 08 8 mm

Osteotomes for septum

185 mm, 7 1/4"

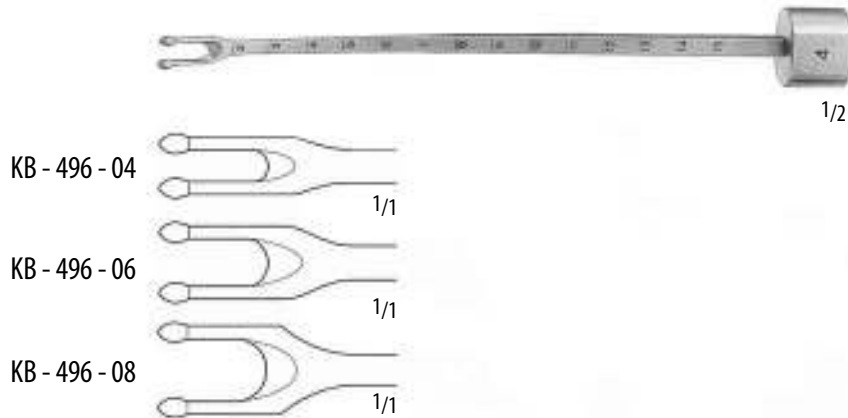

CINELLI

KB - 497 - 10 10 mm

KB - 497 - 12 12 mm

KB - 497 - 14 14 mm

KB - 497 - 16 16 mm

Osteotome, double guarded, straight

160 mm, 6 1/4"

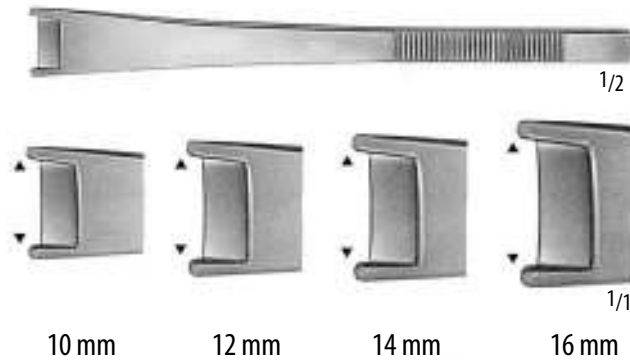

LAMBOTTE

KB - 498 - 04 4 mm

KB - 498 - 06 6 mm

KB - 498 - 08 8 mm

KB - 498 - 10 10 mm

KB - 498 - 12 12 mm

KB - 498 - 15 15 mm

Osteotome

125 mm, 5"

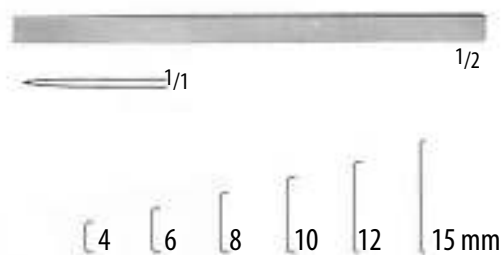

FOMON

KB - 499 - 05 5 mm

KB - 499 - 08 8 mm

Osteotome, single guarded

170 mm, 6 3/4"



GILLIES

KB - 500 - 05 5 mm

KB - 500 - 07 7 mm

KB - 500 - 09 9 mm

Osteotome

140 mm, 5 1/2"

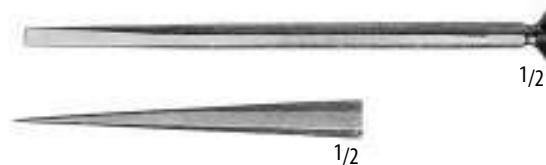

COTTLE

KB - 902 - 18
Mallet, 235 g 1 plain side
1 convex side
 185 mm, 7 1/4"



FOMON

KB - 505 - 21
File, fine / coarse
 215 mm, 8 1/2"

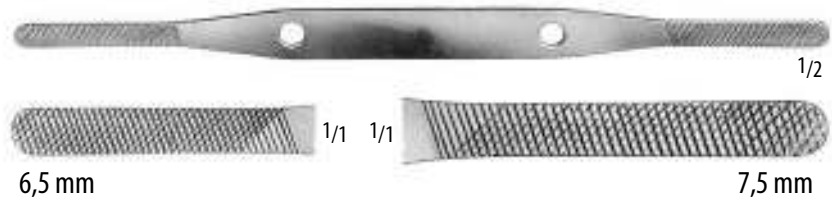

FOMON

KB - 506 - 21
Rasp, fine coarse teeth
 215 mm, 8 1/2"

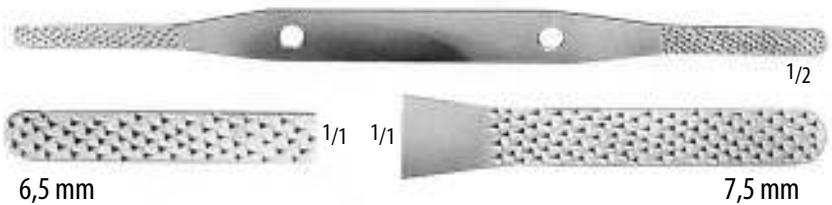

JOSEPH

KB - 507 - 16 fine chequered
 KB - 508 - 16 coarse chequered
Rasp, for filing nasal bones
 165 mm, 6 1/2"

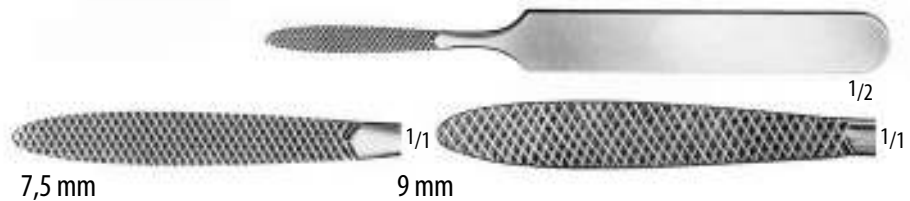

MALTZ

KB - 509 - 18
Rasp, teeth set to cut on down stroke
 180 mm, 7"



MALTZ

KB - 510 - 18 straight
 KB - 511 - 18 straight
Rasp
 180 mm, 7"



with tungsten
carbide inserts



**Rasps, double
ended, with
tungsten
carbide
inserts**
205 mm, 8"

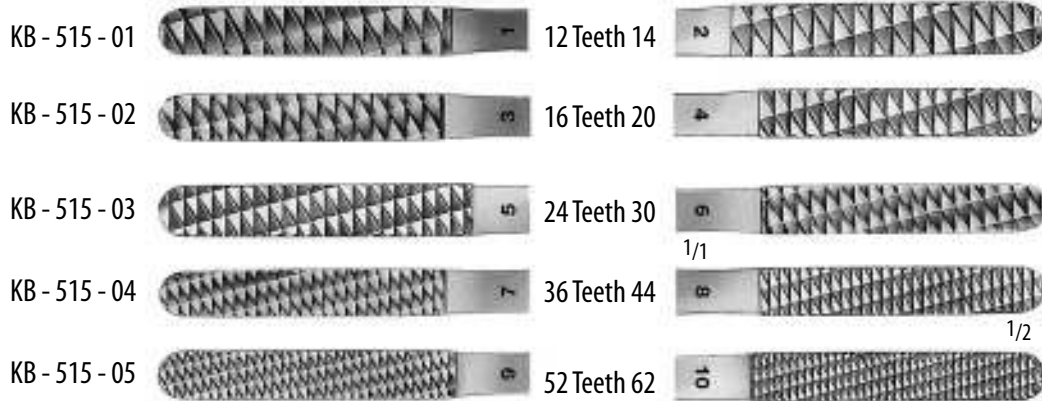

MILLER

KB - 516 - 01
KB - 516 - 02
KB - 516 - 03

Double rasps set to cut on down stroke
180 mm, 7"

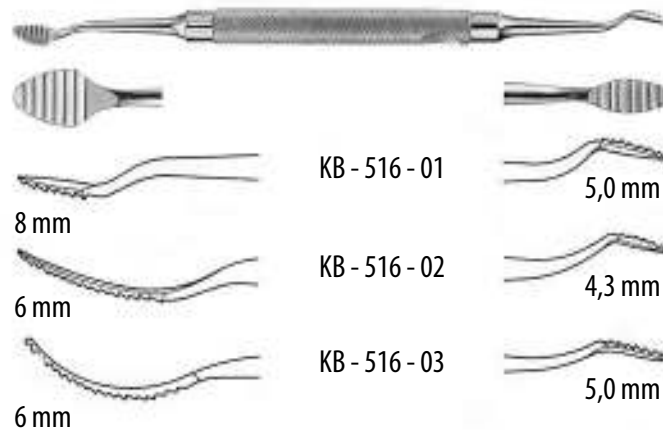

MILLER

KB - 517 - 08 8 mm

Rasps, set to cut on down stroke, fine teeth

KB - 518 - 08 8 mm

Rasps, set to cut on down stroke, coarse teeth
185 mm, 7"

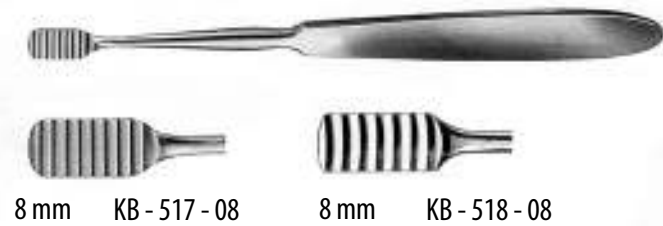

KB - 519 - 08 9 mm

Rasps, set to cut on up stroke

KB - 520 - 08 9 mm

Rasps, set to cut on down stroke
185 mm, 7 1/4"

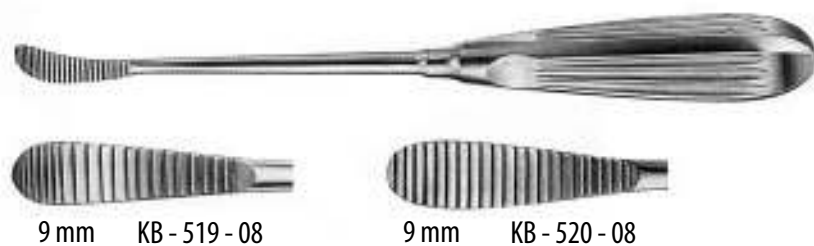

HARTMANN

KB - 525 - 15

Tongue depressor with fenestrated handle

150 mm, 6"



TOBOLD

KB - 526 - 16

Tongue depressor

160 mm, 6 1/4"



LACK

KB - 527 - 13 13 mm

KB - 527 - 19 19 mm

KB - 527 - 22 22 mm

Tongue depressor, curved



WEDER

KB - 528 - 15

KB - 529 - 15

Tongue depressor, fenestrated

150 mm, 6"



DAVIS - MEYER

KB - 530 - 00

Frame only, with two single bites and one double bite, with interchangeable silicone inserts, suitable for all tongue depressors



KB - 530 - 01

Silicone inserts only

KB - 531 - 00

Palate blade to use with KB - 530 - 00, for toothless patients



DAVIS - BOYLE

KB - 532 - 00

Frame only for adults, with interchangeable inserts, suitable for all tongue depressors



DAVIS - BOYLE

KB - 533 - 00

Frame only for children, with interchangeable silicone inserts, suitable for all tongue depressors



KB - 533 - 01

Frame only for adolescents, with interchangeable silicone inserts, suitable for all tongue depressors



DAVIS - BOYLE

KB - 533 - 02

Frame only, suitable for all tongue depressors



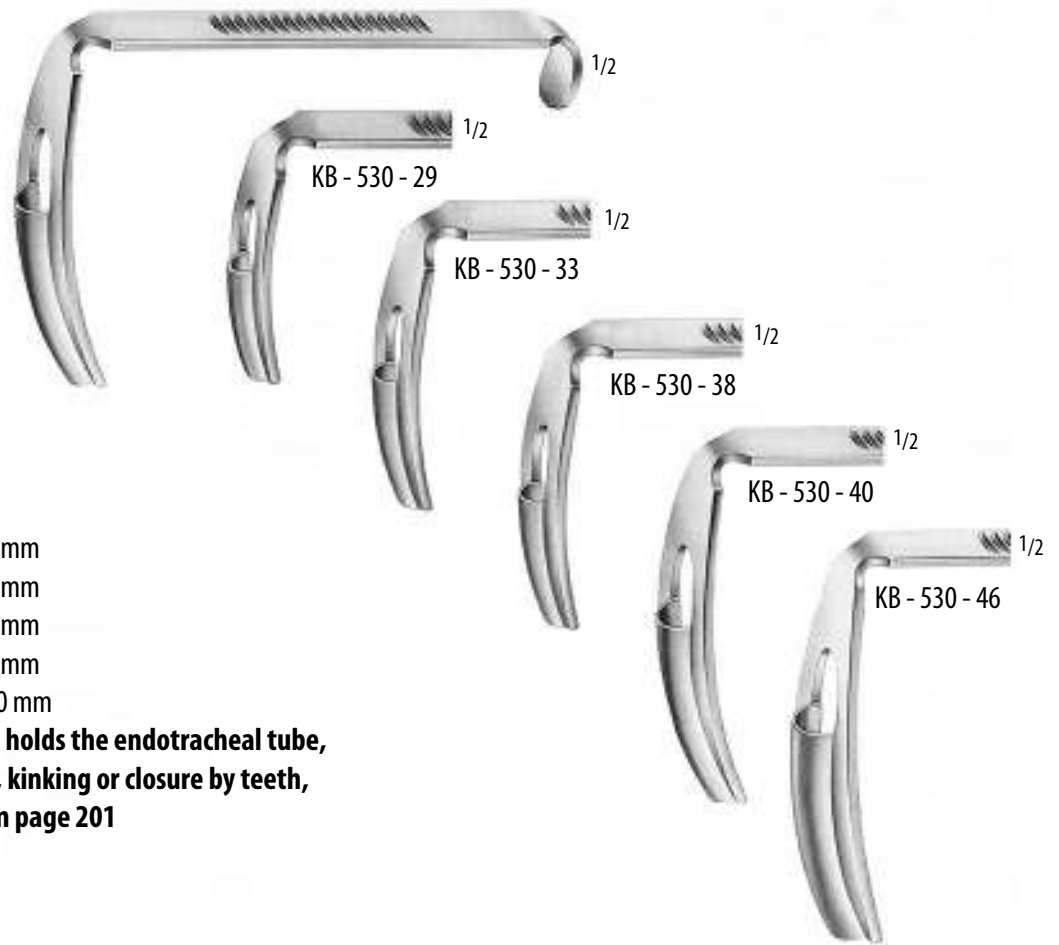

RUSSEL - DAVIS

- KB - 530 - 29 29 x 67 mm
- KB - 530 - 33 33 x 75 mm
- KB - 530 - 38 38 x 85 mm
- KB - 530 - 40 40 x 92 mm
- KB - 530 - 46 46 x 100 mm

Tongue blades, a groove holds the endotracheal tube, protects it from moving, kinking or closure by teeth, suitable for all frames on page 201



RUSSEL - DAVIS

- KB - 532 - 18 18 x 57 mm
- KB - 532 - 22 22 x 67 mm
- KB - 532 - 25 25 x 75 mm

Tongue blades, narrow pattern, with groove for endotracheal tubes, suitable for all frames on page 201

MARSCHIK - KRONE

KB - 540 - 00

Tonsil holding forceps

205 mm, 8"

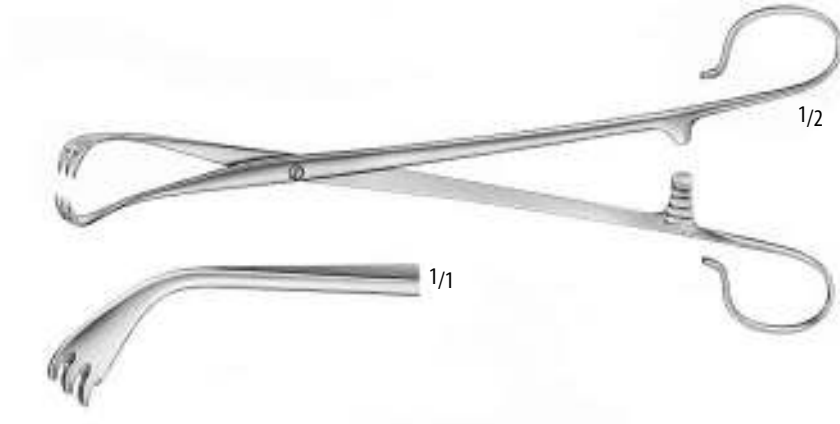

ABRAHAM

KB - 541 - 20

Tonsil holding forceps

205 mm, 8"

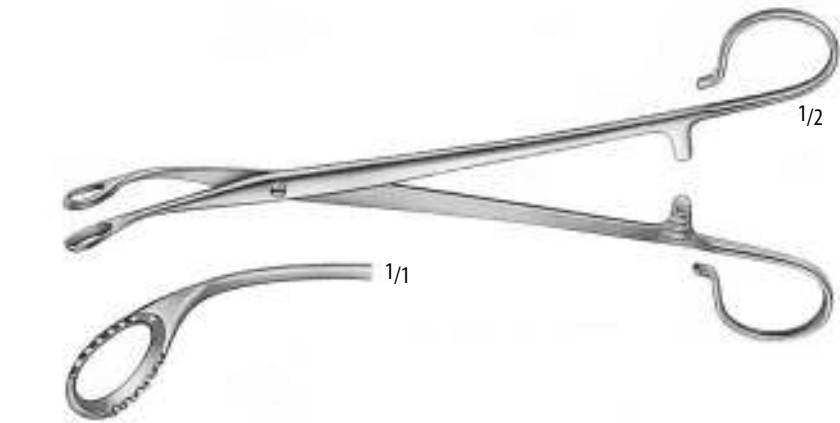

BLOHMKE

KB - 542 - 20

Tonsil holding forceps

205 mm, 8"

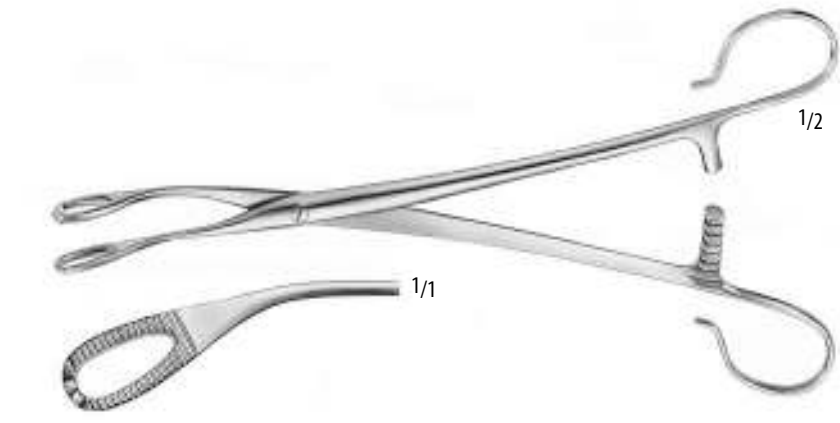

BLOHMKE

KB - 543 - 20

Tonsil holding forceps

205 mm, 8"

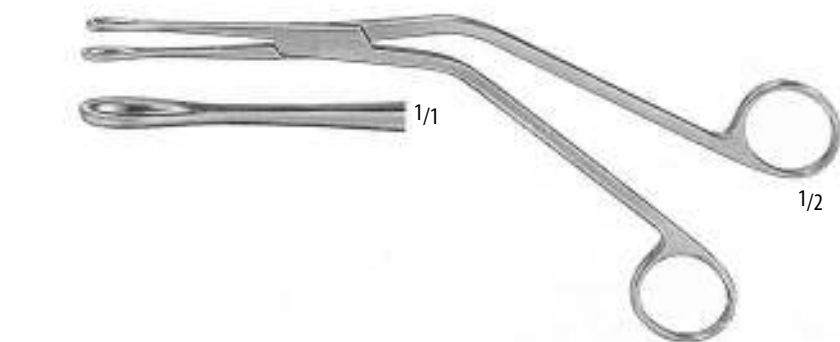

LOPEZ - REINKE

KB - 550 - 23

Tonsil suction dissector

235 mm, 9 1/4"



HURD

KB - 551 - 21

Tonsil dissector and pillar retractor

215 mm, 8 1/2"

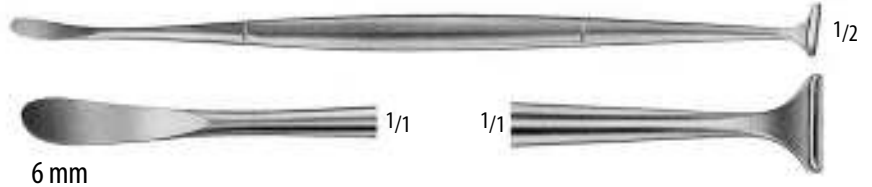

HURD

KB - 552 - 21

Tonsil dissector and pillar retractor

215 mm, 8 1/2"

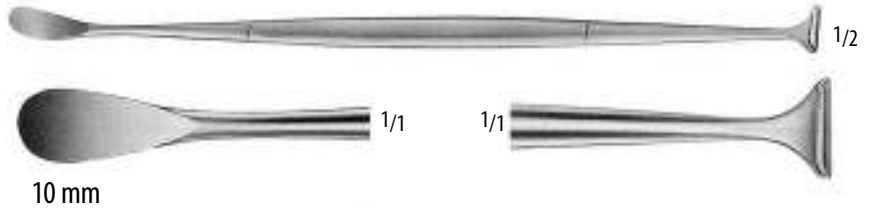

HENKE

KB - 553 - 23

Tonsil dissector and pillar retractor

235 mm, 9 1/4"



HENKE

KB - 554 - 23

Tonsil dissector and pillar retractor

235 mm, 9 1/4"

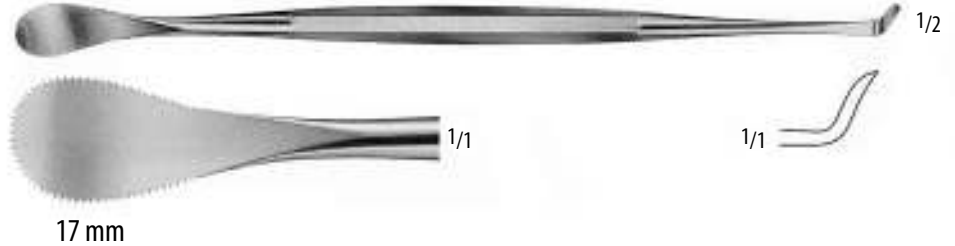

GWYNNE EVANS

KB - 555 - 06

KB - 555 - 08

Tonsil dissector, double ended

200 mm, 8"



SYME

KB - 556 - 18

Tonsil dissector, blunt and semi - sharp

185 mm, 7 1/4"



MOLLINSON

KB - 557 - 21

Tonsil dissector and pillar retractor, semi - sharp

210 mm, 8 1/2"



DEAN

KB - 600 - 17

Tonsil scissors, with angled, serrated blades

170 mm, 6 3/4"

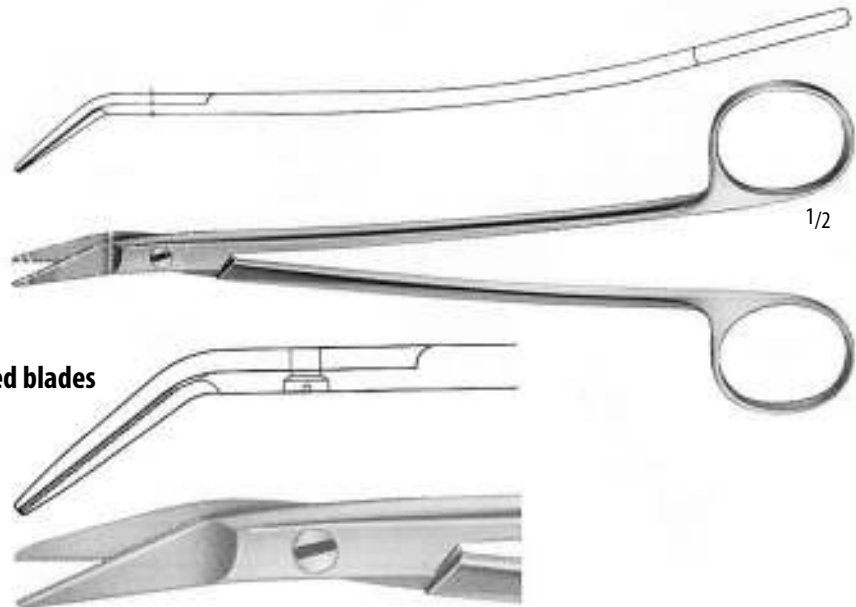

1/2

BOETTCHER

KB - 601 - 18

Tonsil scissors

180 mm, 7"

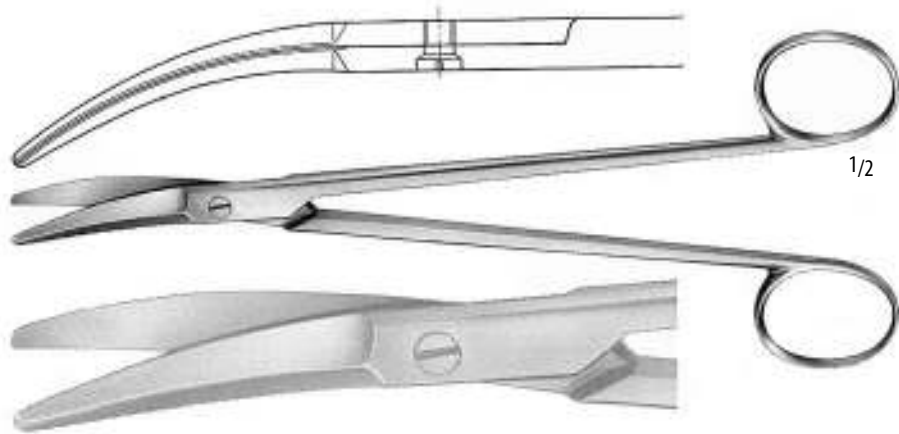

1/2

GOOD

KB - 602 - 19

Tonsil scissors

195 mm, 7 3/4"

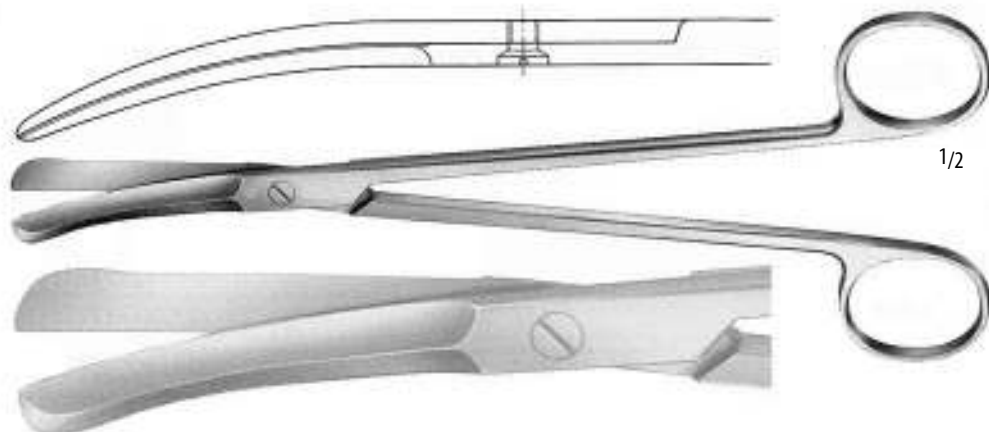

1/2

SCHWECKENDIEK

KB - 603 - 19

Tonsil scissors

195 mm, 7 3/4"

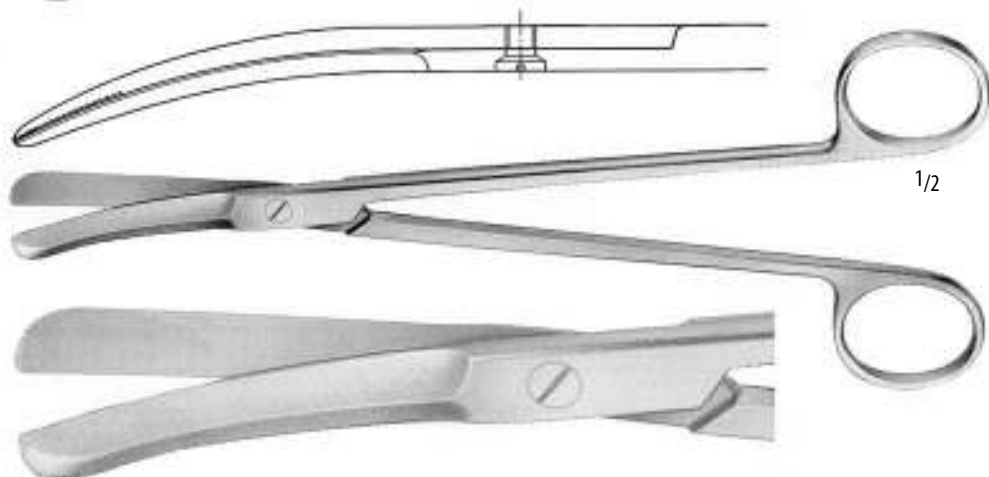

1/2

EVES

KB - 610 - 25

Tonsil snare

250 mm, 10"



EVES

KB - 611 - 25

Tonsil snare

250 mm, 10"



BRUNINGS

KB - 612 - 27

Tonsil snare

270 mm, 10 1/2"



KB - 613 - 03 Ø 0,3 mm

KB - 613 - 05 Ø 0,5 mm

Snare wires, sales unit : DZ = Package of 12 pieces



KB - 614 - 03 Ø 0,3 mm

Wire loops, sales unit : PH = Package of 100 pieces

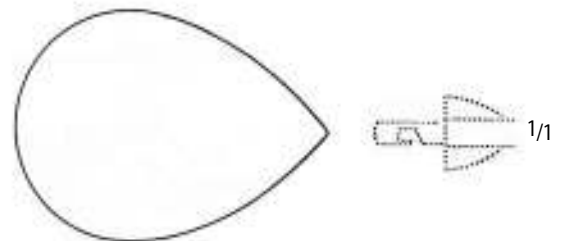

KB - 615 - 04 Ø 0,4 mm

Wire loops, sales unit : PH = Package of 100 pieces

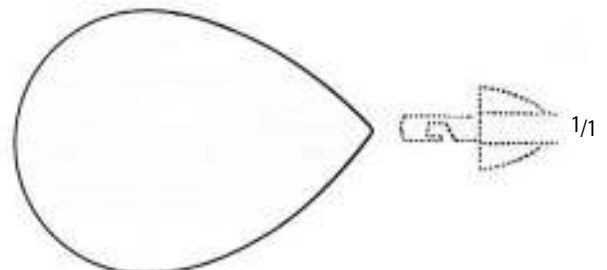

KB - 616 - 03 Ø 0,3 mm

Snare wire in coils of 10 metres



BECKMANN

- KB - 620 - 01
- KB - 620 - 02
- KB - 620 - 03
- KB - 620 - 04
- KB - 620 - 05
- KB - 620 - 06

Adenoid currettes

200 mm, 8"



1/2



KB - 620 - 01



KB - 620 - 02



KB - 620 - 03



KB - 620 - 04

1/1

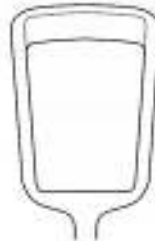

KB - 620 - 05



KB - 620 - 06

1/1

BECKMANN

- KB - 621 - 01
- KB - 621 - 02
- KB - 621 - 03
- KB - 621 - 04
- KB - 621 - 05
- KB - 621 - 06

Adenoid currettes

220 mm, 8 3/4"



1/2



KB - 621 - 01



KB - 621 - 02



KB - 621 - 03

1/1



KB - 621 - 04



KB - 621 - 05



KB - 621 - 06

1/1



1/2

BARNHILL

KB - 622 - 01

KB - 622 - 02

KB - 622 - 03

KB - 622 - 04

Adenoid curettes

200 mm, 8"



KB - 622 - 01



KB - 622 - 02

1/1



KB - 622 - 03



KB - 622 - 04

1/1



1/2

ST. CLAIR - THOMPSON

KB - 623 - 01

KB - 623 - 02

KB - 623 - 03

Adenoid curette with cage

212 mm, 8 1/4"



KB - 623 - 01



KB - 623 - 02



KB - 623 - 03

1/1

KB - 624 - 01

KB - 624 - 02

Adenoid curette with cage

214 mm, 8 1/2"

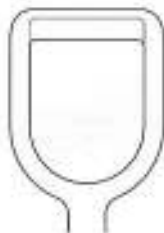

KB - 624 - 01

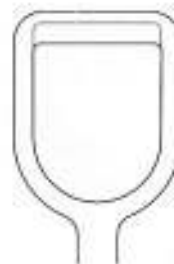

KB - 624 - 02



KB - 624 - 03

1/1

KB - 624 - 03

Adenoid curette with cage

216 mm

LAFORCE

KB - 625 - 01

KB - 625 - 02

KB - 625 - 03

Adenotomes

230 mm, 9"

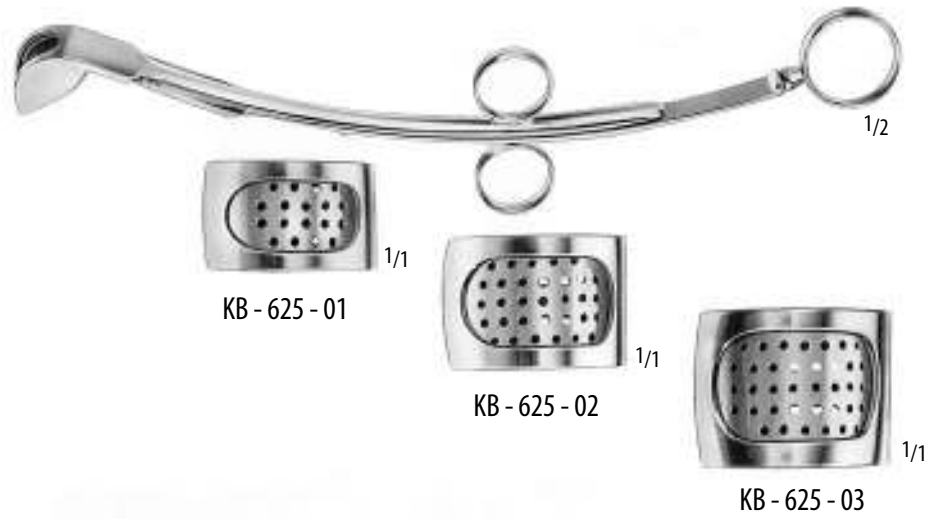

JATHO

KB - 626 - 01

Biopsy forceps, for nasopharynx and hypopharynx, malleable shaft, right side opening

KB - 626 - 02

Biopsy forceps, for nasopharynx and hypopharynx, malleable shaft, left side opening

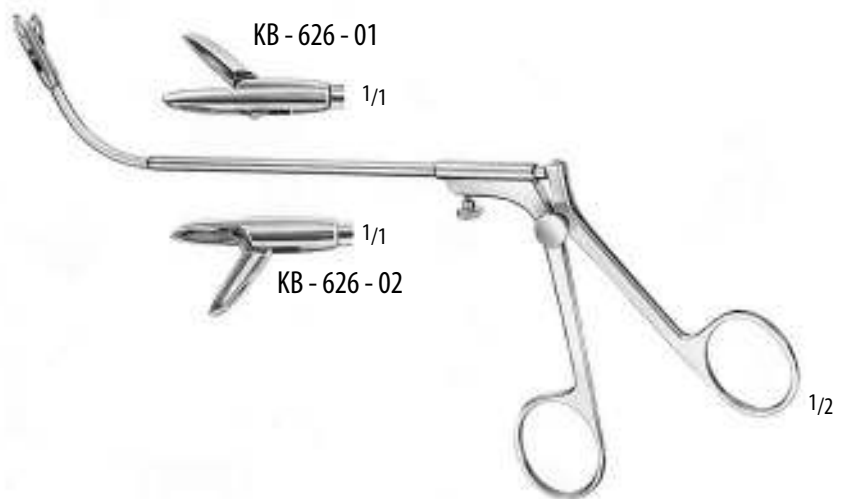

JATHO

KB - 627 - 24

Nasopharynx forceps

240 mm, 9 1/2"

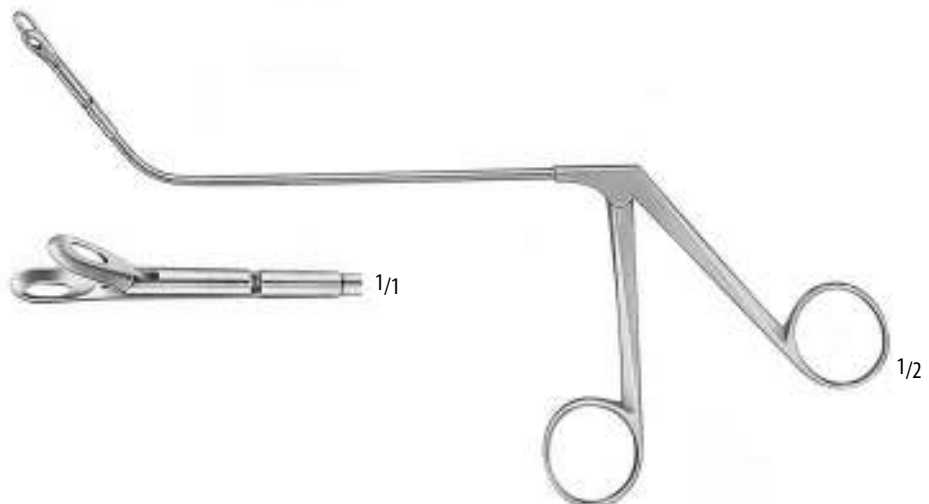

KB - 630 - 00

Chest support and laryngoscope holder, complete for adults and children



KB - 631 - 01

Operating laryngoscope for adults, large size



KB - 631 - 02

Operating laryngoscope for adults, medium size



KB - 631 - 03

Operating laryngoscope for adolescents, small size



KB - 631 - 04

Operating laryngoscope for children



1/2

KB - 631 - 10

Light guide for use laryngoscopes KB - 631 - 01, KB - 631 - 02, KB - 631 - 03



1/2

KB - 631 - 11

Light guide for use laryngoscopes KB - 631 - 04



1/2

KB - 634 - 00

Teeth protector



1/2

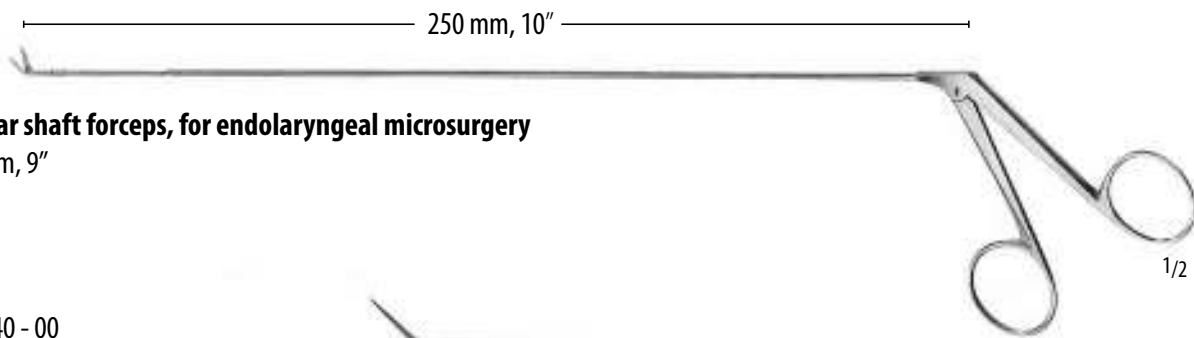

Tubular shaft forceps, for endolaryngeal microsurgery

250 mm, 9"

KB - 640 - 00

Micro-laryngeal grasping forceps



KB - 640 - 01

Micro-laryngeal grasping forceps, curved to left



KB - 640 - 02

Micro-laryngeal grasping forceps, curved to right



KB - 640 - 03 Ø 2 mm

Micro-laryngeal, cup - shaped forceps, straight



KB - 640 - 04 Ø 2 mm

Micro-laryngeal, cup - shaped forceps, curved to left



KB - 640 - 05 Ø 2 mm

Micro-laryngeal, cup - shaped forceps, curved to right



KB - 640 - 06 Ø 2 mm

Micro-laryngeal, cup - shaped forceps, upwards angled



KB - 640 - 07

Micro-laryngeal scissors, straight



KB - 640 - 08

Micro-laryngeal scissors, curved to left



KB - 640 - 09
**Micro-laryngeal scissors,
curved to right**



KB - 640 - 10
**Micro-laryngeal scissors,
upwards angled**



KB - 640 - 11
Cartilage forceps
250 mm, 10"



KB - 640 - 12
Laryngeal needle holder
225 mm, 9"

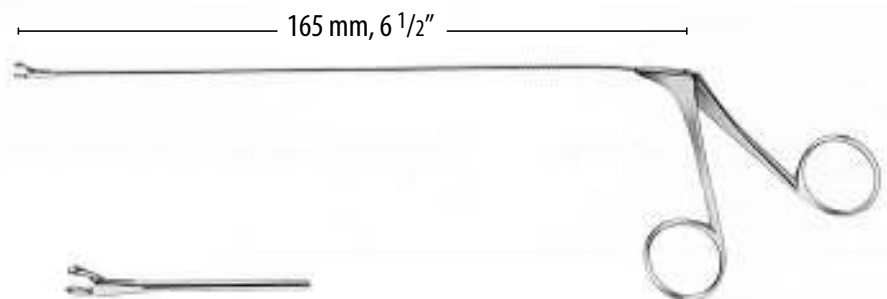

KB - 641 - 00
Forceps, scoop-shaped, sharp
165 mm, 6 1/2"



YASARGIL - NICOLA
KB - 641 - 02
Forceps, long conical jaws
165 mm, 6 1/2"



KB - 641 - 03
Scissors, straight
165 mm, 6 1/2"



TROUSSEAU

KB - 700 - 12

Tracheal dilaton

120 mm, 4 ³/₄"



1/2

LABORDE

KB - 701 - 12

Tracheal dilator

125 mm, 5"



1/2

LABORDE

KB - 701 - 13

Tracheal dilator

135 mm, 5 ¹/₄"



1/2

BOSE

KB - 702 - 16

Tracheal ligature needle, left for the right hand

165 mm, 6 ¹/₂"



1/2

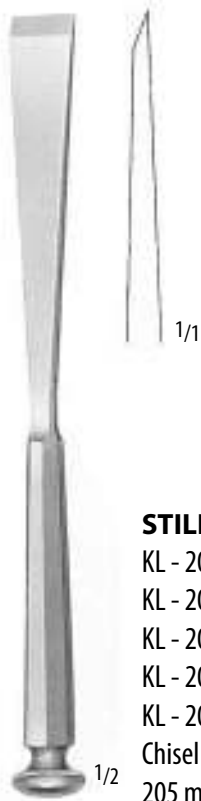

STILLE

- KL - 200 - 10 10 mm
- KL - 200 - 12 2 mm
- KL - 200 - 15 15 mm
- KL - 200 - 20 20 mm
- KL - 200 - 25 25 mm

Chisel
205 mm, 8"

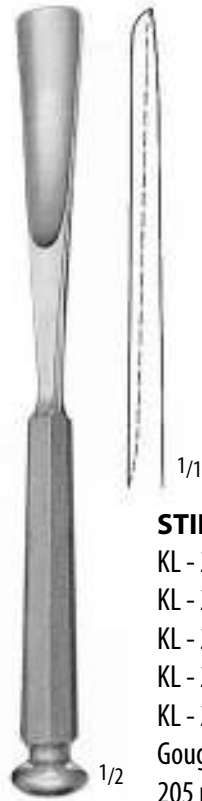

STILLE

- KL - 201 - 10 10 mm
- KL - 201 - 12 12 mm
- KL - 201 - 15 15 mm
- KL - 201 - 20 20 mm
- KL - 201 - 25 25 mm

Gouges
205 mm, 8"



WALTER

- KL - 202 - 10 10 mm
- KL - 202 - 15 15 mm

205 mm, 8"



STILLE

- KL - 203 - 08 8 mm
- KL - 203 - 10 10 mm
- KL - 203 - 12 12 mm
- KL - 203 - 15 15 mm
- KL - 203 - 20 20 mm
- KL - 203 - 25 25 mm

Osteotomes
205 mm, 8"

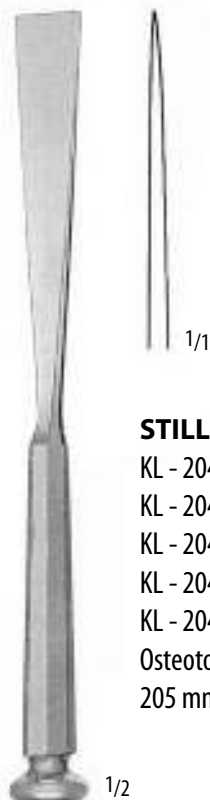

STILLE

- KL - 204 - 10 10 mm
- KL - 204 - 12 12 mm
- KL - 204 - 15 15 mm
- KL - 204 - 20 20 mm
- KL - 204 - 25 25 mm

Osteotomes
205 mm, 8"

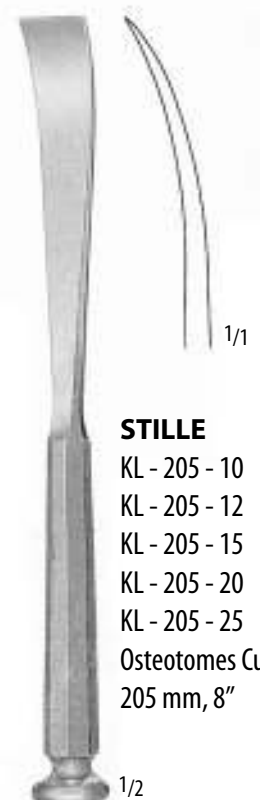

STILLE

- KL - 205 - 10 10 mm
- KL - 205 - 12 12 mm
- KL - 205 - 15 15 mm
- KL - 205 - 20 20 mm
- KL - 205 - 25 25 mm

Osteotomes Curved
205 mm, 8"

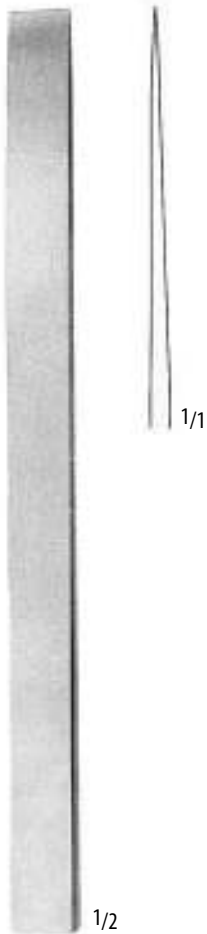

LAMBOTTE

- KL - 250 - 04 4 mm
- KL - 250 - 08 8 mm
- KL - 250 - 10 10 mm
- KL - 250 - 13 13 mm
- KL - 250 - 15 15 mm
- KL - 250 - 18 18 mm
- KL - 250 - 20 20 mm
- KL - 250 - 25 25 mm
- KL - 250 - 30 30 mm
- KL - 250 - 38 38 mm
- KL - 250 - 44 44 mm
- KL - 250 - 50 50 mm
- Osteotomes
245 mm, 9³/₄"

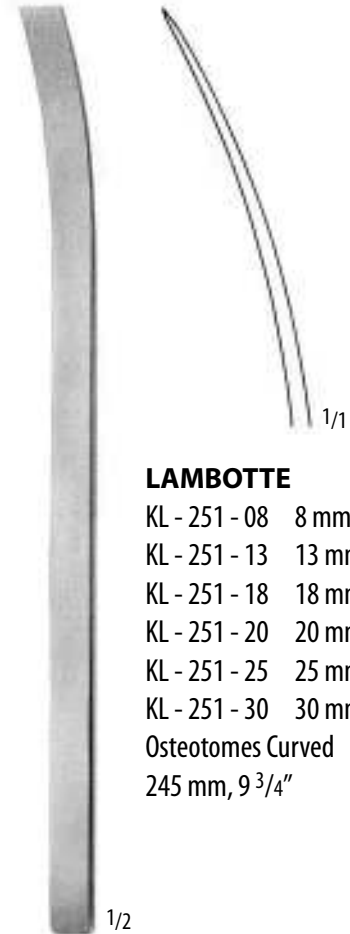

LAMBOTTE

- KL - 251 - 08 8 mm
- KL - 251 - 13 13 mm
- KL - 251 - 18 18 mm
- KL - 251 - 20 20 mm
- KL - 251 - 25 25 mm
- KL - 251 - 30 30 mm
- Osteotomes Curved
245 mm, 9³/₄"

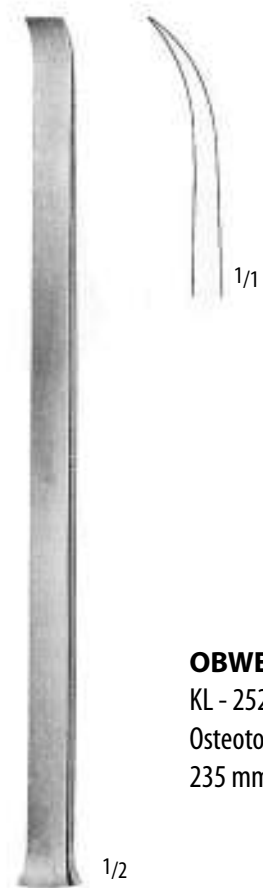

OBWEGESER

- KL - 252 - 11 11 mm
- Osteotome, Curved
235 mm, 9¹/₄"



NIEDERDELLMANN

- KL - 253 - 08 8 mm
- KL - 253 - 10 10 mm
- Osteotomes Curved
250 mm, 10"



STANDARD

Fig. 1
straight

MA - 100 - 10	10,5 cm / 4 1/4"	MA - 101 - 10
MA - 100 - 11	11,5 cm / 4 1/2"	MA - 101 - 11
MA - 100 - 13	13,0 cm / 5"	MA - 101 - 13
MA - 100 - 14	14,5 cm / 5 1/2"	MA - 101 - 14
MA - 100 - 15	15,5 cm / 6"	MA - 101 - 15
MA - 100 - 16	16,5 cm / 6 1/2"	MA - 101 - 16
MA - 100 - 17	17,5 cm / 7"	MA - 101 - 17
MA - 100 - 18	18,5 cm / 7 1/4"	MA - 101 - 18
MA - 100 - 20	20,0 cm / 8"	MA - 101 - 20

STANDARD

Fig. 1
curved



Original 14,5 cm



STANDARD

Fig. 2
straight

MA - 102 - 10	10,5 cm / 4 1/4"	MA - 103 - 10
MA - 102 - 11	11,5 cm / 4 1/2"	MA - 103 - 11
MA - 102 - 13	13,0 cm / 5"	MA - 103 - 13
MA - 102 - 14	14,5 cm / 5 1/2"	MA - 103 - 14
MA - 102 - 15	15,5 cm / 6"	MA - 103 - 15
MA - 102 - 16	16,5 cm / 6 1/2"	MA - 103 - 16
MA - 102 - 17	17,5 cm / 7"	MA - 103 - 17
MA - 102 - 18	18,5 cm / 7 1/4"	MA - 103 - 18
MA - 102 - 20	20,0 cm / 8"	MA - 103 - 20

STANDARD

Fig. 2
curved

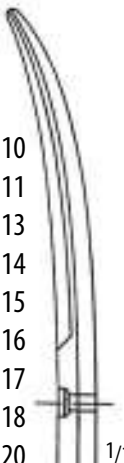

Original 14,5 cm



Original 16,5 cm



STANDARD

Fig. 3
straight

MA - 104 - 10	10,5 cm / 4 1/4"	MA - 105 - 10
MA - 104 - 11	11,5 cm / 4 1/2"	MA - 105 - 11
MA - 104 - 13	13,0 cm / 5"	MA - 105 - 13
MA - 104 - 14	14,5 cm / 5 1/2"	MA - 105 - 14
MA - 104 - 15	15,5 cm / 6"	MA - 105 - 15
MA - 104 - 16	16,5 cm / 6 1/2"	MA - 105 - 16
MA - 104 - 17	17,5 cm / 7"	MA - 105 - 17
MA - 104 - 18	18,5 cm / 7 1/4"	MA - 105 - 18
MA - 104 - 20	20,0 cm / 8"	MA - 105 - 20

STANDARD

Fig. 3
curved

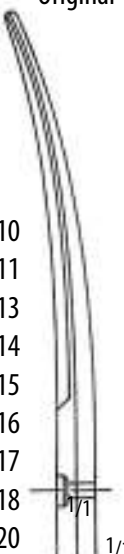

Original 16,5 cm





GRAZIL
Fig. 1
straight

MA - 106 - 13 13,0 cm / 5"
MA - 106 - 14 14,5 cm / 5 1/2"



GRAZIL
Fig. 1
curved

MA - 107 - 13
MA - 107 - 14 1/1

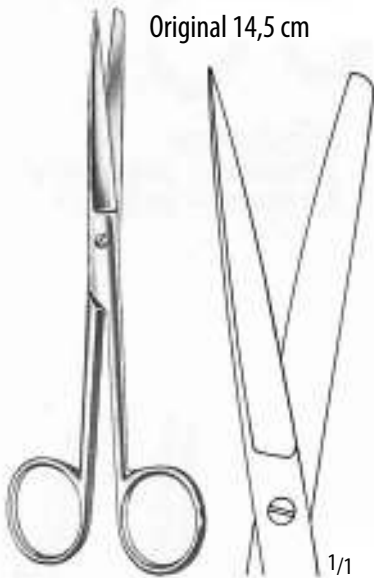

GRAZIL
Fig. 2
straight

MA - 108 - 13 13,0 cm / 5"
MA - 108 - 14 14,5 cm / 5 1/2"



GRAZIL
Fig. 2
curved

MA - 109 - 13
MA - 109 - 14 1/1



GRAZIL
Fig. 3
straight

MA - 110 - 13 13,0 cm / 5"
MA - 110 - 14 14,5 cm / 5 1/2"



GRAZIL
Fig. 3
curved

MA - 111 - 13
MA - 111 - 14 1/1



Incision Scissors

MA - 112 - 13 = 13,0 cm / 5"
MA - 112 - 14 = 14,5 cm / 5 1/2"

MA - 113 - 15
15,5 cm / 6"

RICHTER
MA - 114 - 14
14,5 cm / 5 1/2"

FERGUSON
MA - 115 - 16 = 16,5 cm / 6 1/2"
MA - 115 - 18 = 18,0 cm / 7"



DEAVER
MA - 116 - 14 14,0 cm / 5 1/2" MA - 117 - 14

MIXTER
MA - 118 - 15 15,5 cm / 6" MA - 119 - 15

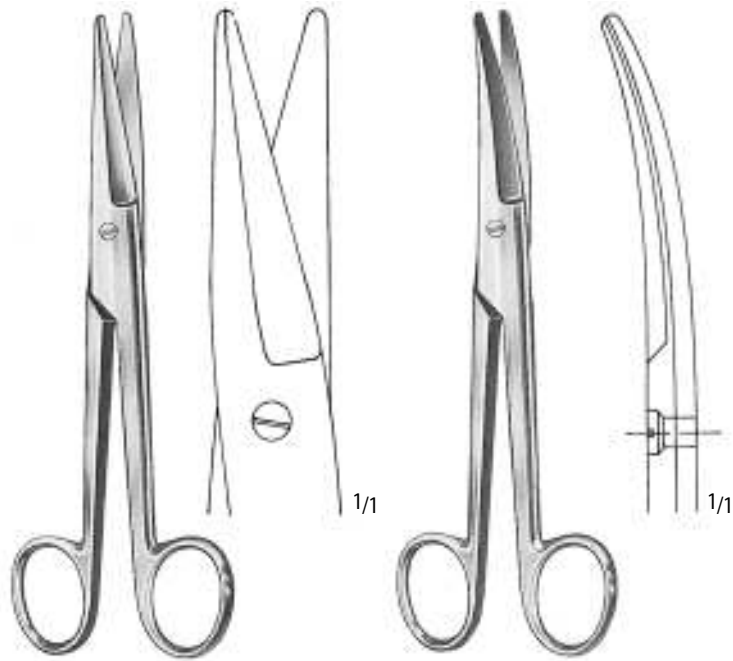

MAYO - NOBLE

MA - 120 - 17 17,0 cm / 6³/₄" MA - 121 - 17

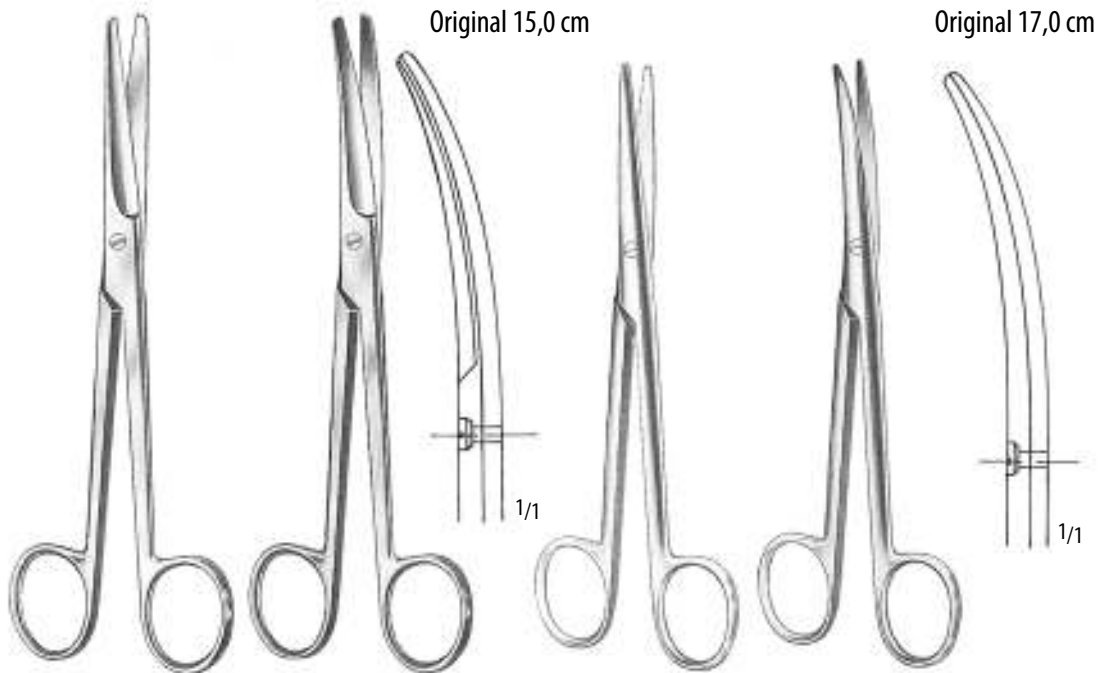

MAYO

MAYO - STILLE

14,5 cm / 5 1/2"	MA - 125 - 14	MA - 126 - 14		
15,0 cm / 6"			MA - 127 - 15	MA - 128 - 15
17,0 cm / 6 3/4"	MA - 125 - 17	MA - 126 - 17	MA - 127 - 17	MA - 128 - 17
19,5 cm / 7 3/4"			MA - 127 - 19	MA - 128 - 19
21,0 cm / 8 1/4"			MA - 127 - 21	MA - 128 - 21
23,0 cm / 9"	MA - 125 - 23	MA - 126 - 23		
28,0 cm / 11"	MA - 125 - 28	MA - 126 - 28		



DOYEN
MA - 129 - 16
16,0 cm / 6 1/4"

DOYEN
MA - 130 - 16
16,0 cm / 6 1/4"

DOYEN
MA - 131 - 16
16,0 cm / 6 1/4"

DOYEN
MA - 132 - 18
17,5 cm / 7"

DOYEN
MA - 133 - 18
17,5 cm / 7"

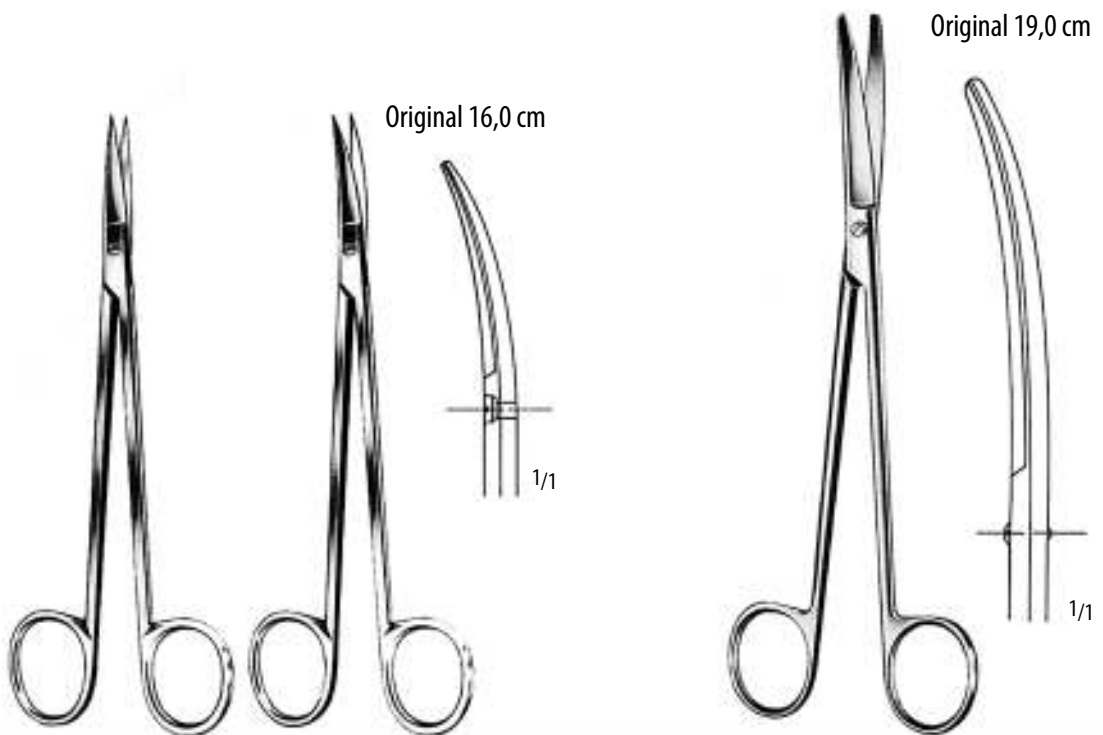

KELLY
MA - 134 - 16 16,0 cm / 6 1/4" MA - 135 - 16
MA - 134 - 18 18,0 cm / 7" MA - 135 - 18

WERTHEIM
14,5 cm / 5 3/4" MA - 136 - 14
19,5 cm / 7 3/4" MA - 136 - 19
22,5 cm / 9 MA - 136 - 22



20,0 cm / 8"
23,0 cm / 9"

MA - 140 - 20
MA - 140 - 23



MA - 141 - 20
MA - 141 - 23



MA - 142 - 20
MA - 142 - 23

straight
SIMS



MA - 143 - 20
MA - 143 - 23



Original 20,0 cm



MA - 144 - 20
MA - 144 - 23



MA - 145 - 20
MA - 145 - 23

curved
SIMS



DUBOIS
MA - 146 - 27
27,0 cm / 10 1/2"



DUBOIS
MA - 147 - 27
27,0 cm / 10 1/2"

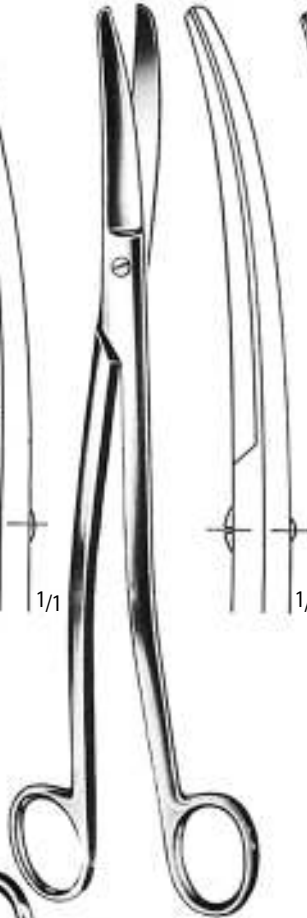

SIEBOLD
MA - 148 - 24
24,0 cm / 9 1/2"

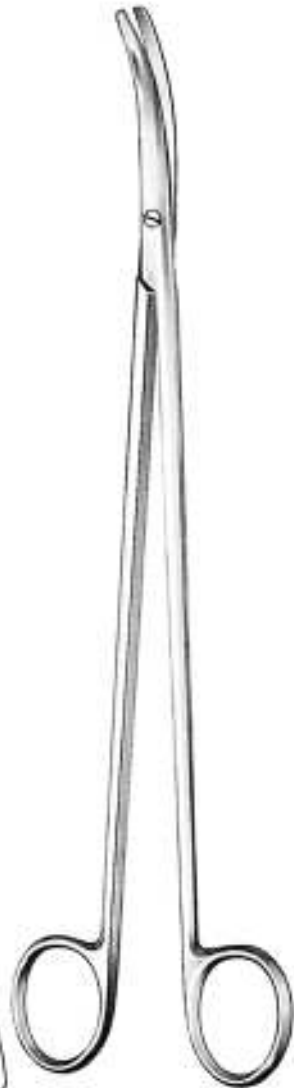

CARDINALE
MA - 149 - 28
28,0 cm / 11"



Fig. 1
straight

Fig. 1
curved

METZENBAUM

MA - 149 - 14
14,5 cm / 5 1/2"

MA - 150 - 14
14,5 cm / 5 1/2"

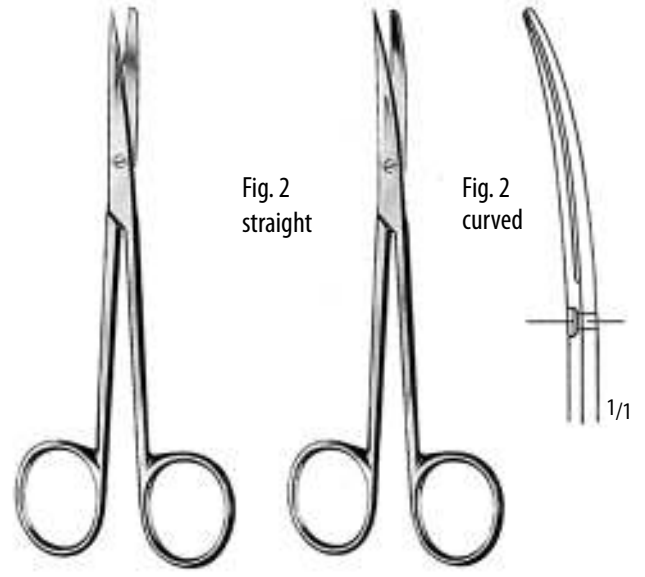

Fig. 2
straight

Fig. 2
curved

METZENBAUM

MA - 151 - 14
14,5 cm / 5 1/2"

MA - 152 - 14
14,5 cm / 5 1/2"

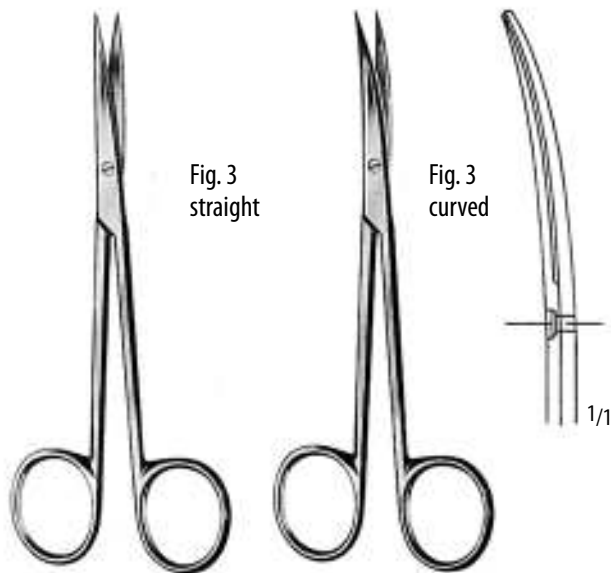

Fig. 3
straight

Fig. 3
curved

METZENBAUM

MA - 153 - 14
14,5 cm / 5 1/2"

MA - 154 - 14
14,5 cm / 5 1/2"

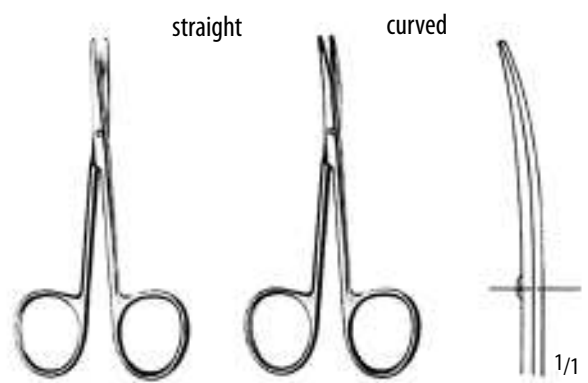

straight

curved

METZENBAUM - BABY

MA - 155 - 11

MA - 156 - 11

11,5 cm / 4 1/2"

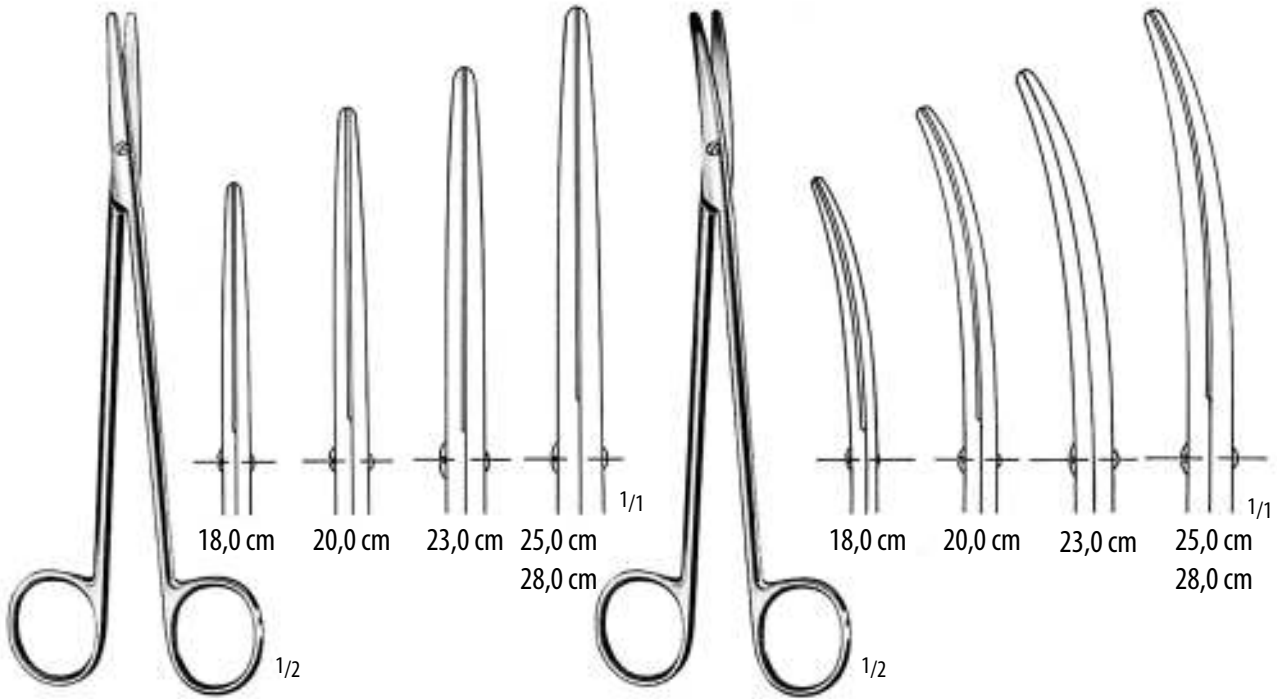

METZENBAUM - NELSON

METZENBAUM - NELSON



Fig. 1

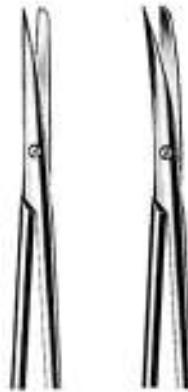

Fig. 2



Fig. 3

18,0 cm / 7"	MA - 200 - 18	MA - 201 - 18	MA - 202 - 18	MA - 203 - 18	MA - 204 - 18	MA - 205 - 18
20,0 cm / 8"	MA - 200 - 20	MA - 201 - 20	MA - 202 - 20	MA - 203 - 20	MA - 204 - 20	MA - 205 - 20
23,0 cm / 9"	MA - 200 - 23	MA - 201 - 23	MA - 202 - 23	MA - 203 - 23	MA - 204 - 23	MA - 205 - 23
25,0 cm / 10"	MA - 200 - 25	MA - 201 - 25	MA - 202 - 25	MA - 203 - 25	MA - 204 - 25	MA - 205 - 25
28,0 cm / 11"	MA - 200 - 28	MA - 201 - 28	MA - 202 - 28	MA - 203 - 28	MA - 204 - 28	MA - 205 - 28
30,0 cm / 12"	MA - 200 - 30	MA - 201 - 30	MA - 202 - 30	MA - 203 - 30	MA - 204 - 30	MA - 205 - 30

METZENBAUM - DELICATE

Fig. 1
 MA - 210 - 14
 14,5 cm / 5 1/2"

Fig. 1
 MA - 211 - 14
 14,5 cm / 5 1/2"

Fig. 3
 MA - 212 - 14
 14,5 cm / 5 1/2"

Fig. 3
 MA - 213 - 14
 14,5 cm / 5 1/2"

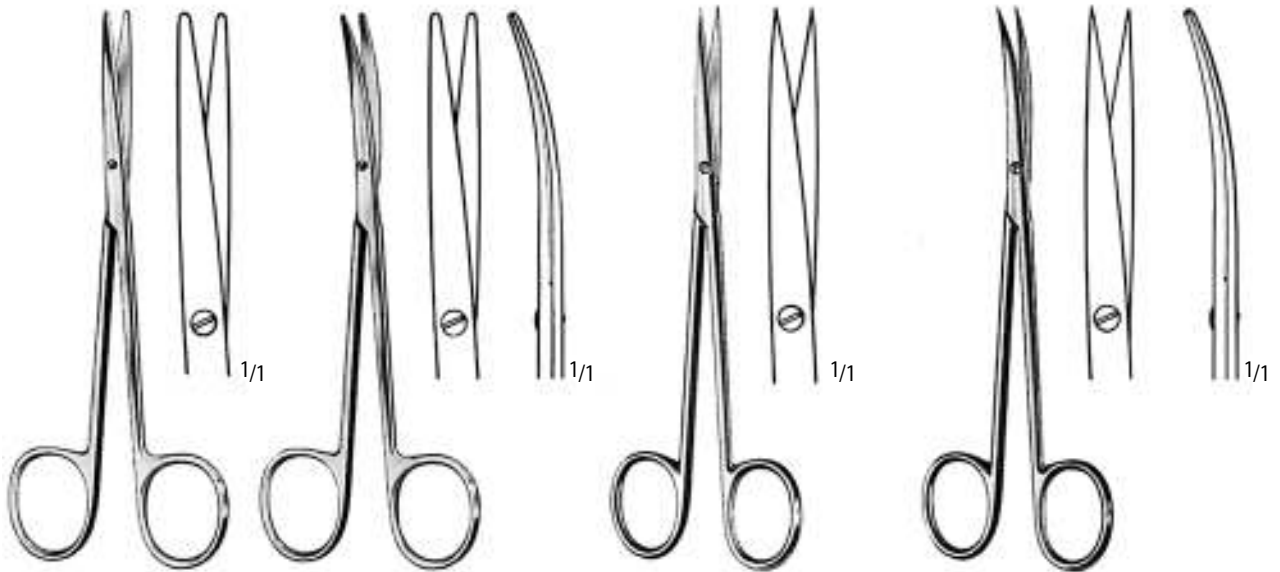
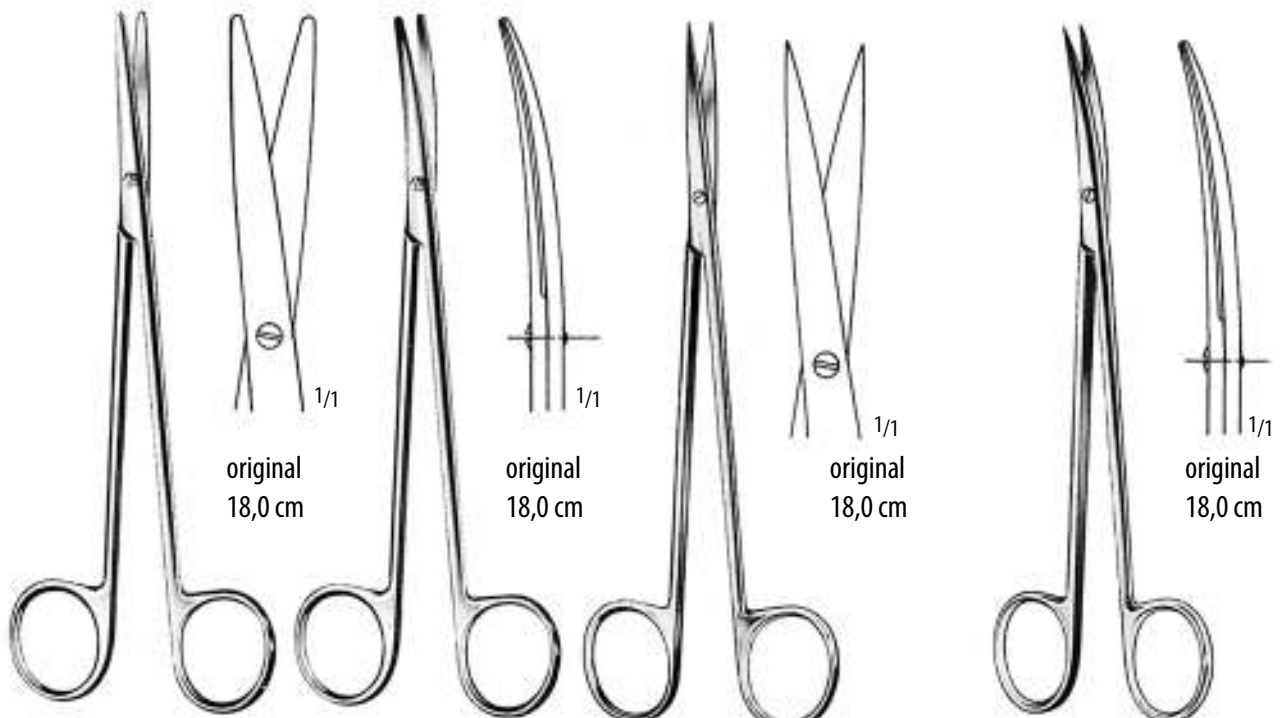

Fig. 1

Fig. 1

Fig. 3

Fig. 3

18,0 cm / 7"	MA - 214 - 18	MA - 215 - 18	MA - 216 - 18	MA - 217 - 18
20,0 cm / 8"	MA - 214 - 20	MA - 215 - 20	MA - 216 - 20	MA - 217 - 20
23,0 cm / 9"	MA - 214 - 23	MA - 215 - 23	MA - 216 - 23	MA - 217 - 23
25,0 cm / 10"	MA - 214 - 25	MA - 215 - 25	MA - 216 - 25	MA - 217 - 25
28,0 cm / 11"	MA - 214 - 28	MA - 215 - 28	MA - 216 - 28	MA - 217 - 28
30,0 cm / 12"	MA - 214 - 30	MA - 215 - 30	MA - 216 - 30	MA - 217 - 30

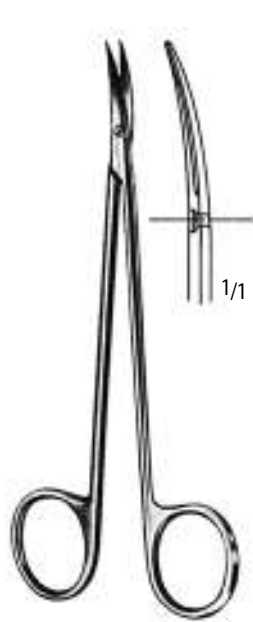

straight

MA - 218 - 15
15,0 cm / 6"



curved

MA - 219 - 15
15,0 cm / 6"

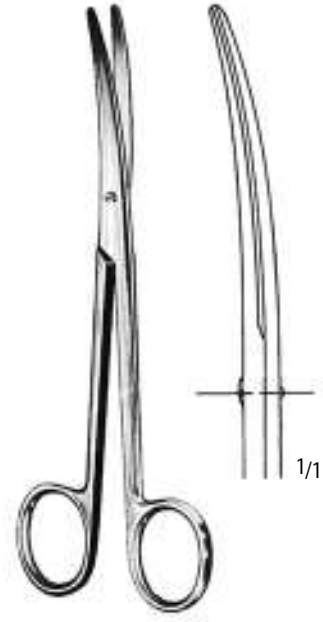

LEXER

MA - 220 - 16
16,0 cm / 6 1/4"

LEXER

MA - 221 - 16
16,0 cm / 6 1/4"

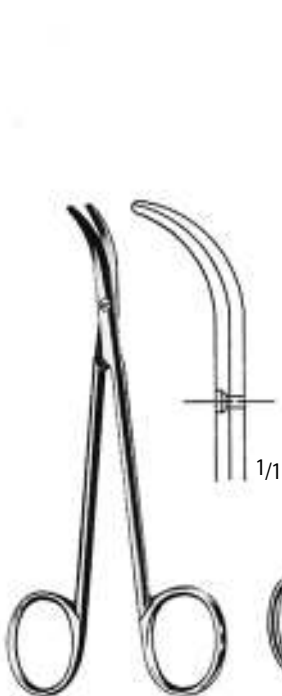

FOMON

MA - 222 - 13
13,5 cm / 5 1/4"

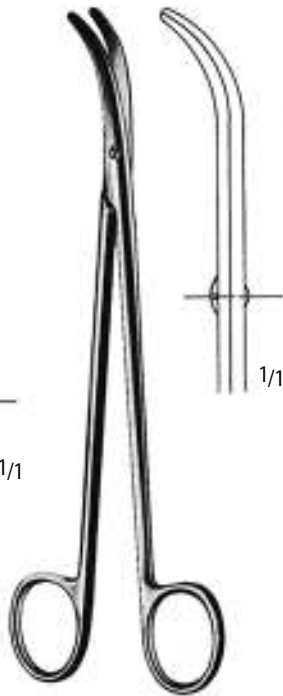

THOREK

MA - 223 - 19
19,0 cm / 7 1/2"



LEXER - BABY

MA - 224 - 10
10,0 cm / 4"

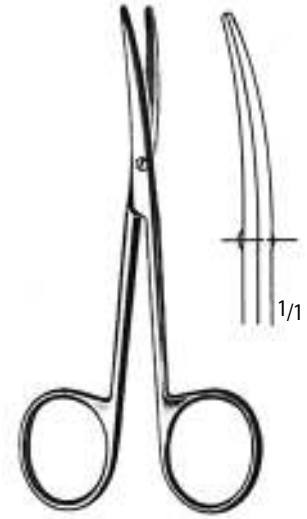

LEXER - BABY

MA - 225 - 10
10,0 cm / 4"



SANVENERO

MA - 226 - 14 MA - 227 - 14
14,0 cm / 5 1/2" 14,0 cm / 5 1/2"

JOSEPH

MA - 228 - 14 MA - 229 - 14
14,0 cm / 5 1/2" 14,0 cm / 5 1/2"



KILNER (RAGNELL)

MA - 230 - 12	12,0 cm / 4 3/4"	MA - 231 - 12
MA - 230 - 15	15,0 cm / 6"	MA - 231 - 15
MA - 230 - 18	18,0 cm / 7"	MA - 231 - 18
MA - 230 - 20	20,0 cm / 8"	MA - 231 - 20

REYNOLDS

MA - 232 - 15	15,0 cm / 6"	MA - 233 - 15
MA - 232 - 18	18,0 cm / 7"	MA - 233 - 18

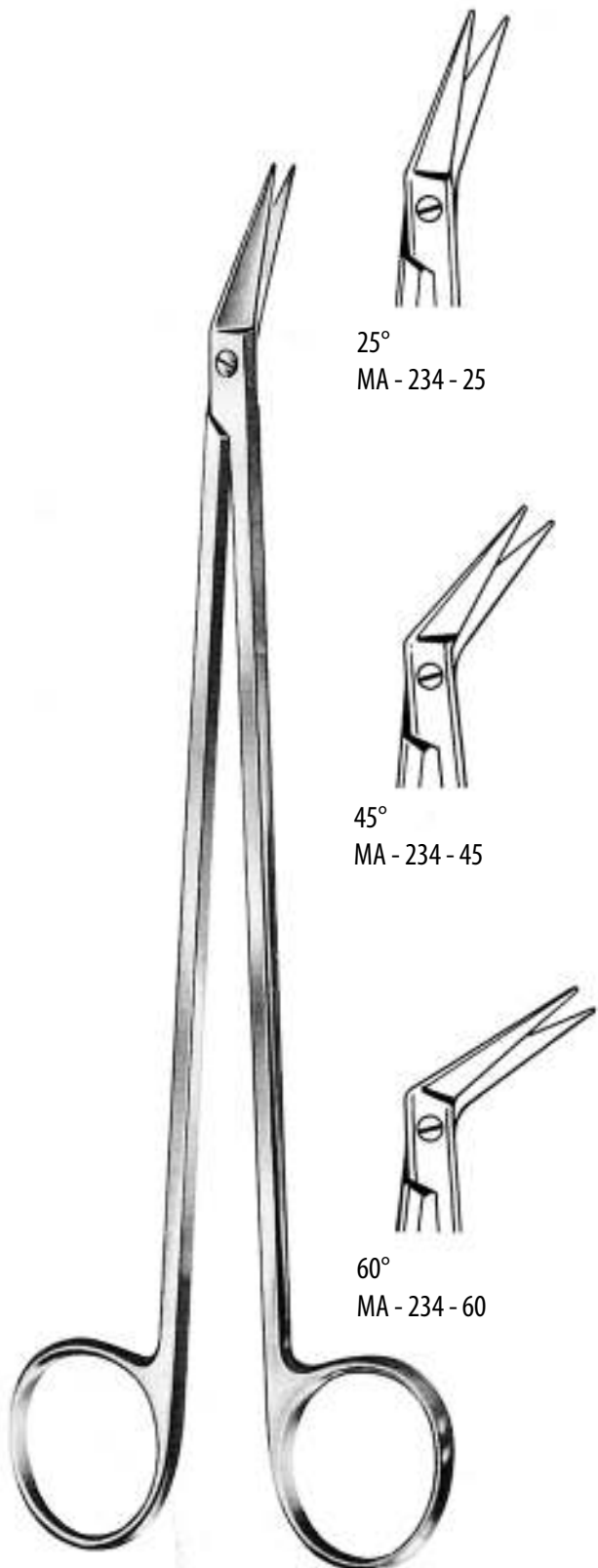

25°
MA - 234 - 25

45°
MA - 234 - 45

60°
MA - 234 - 60

POTTS - SMITH
19,0 cm / 7 1/2"

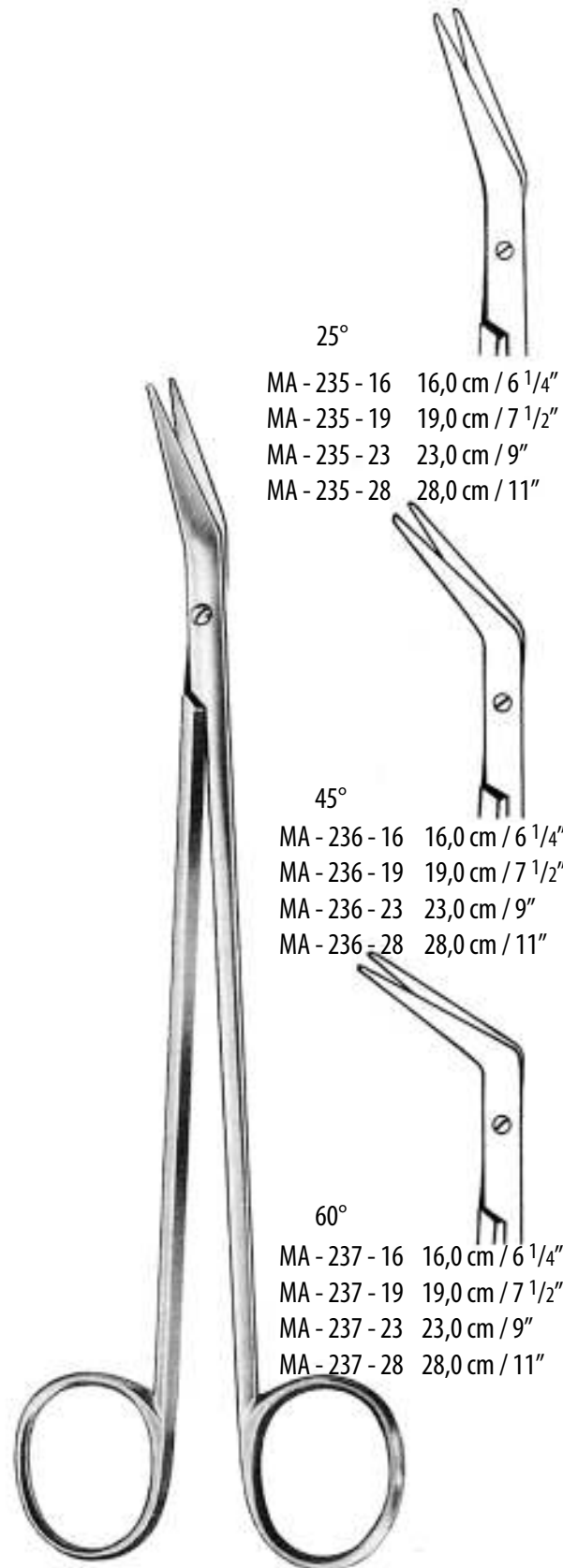

25°

MA - 235 - 16 16,0 cm / 6 1/4"
MA - 235 - 19 19,0 cm / 7 1/2"
MA - 235 - 23 23,0 cm / 9"
MA - 235 - 28 28,0 cm / 11"

45°

MA - 236 - 16 16,0 cm / 6 1/4"
MA - 236 - 19 19,0 cm / 7 1/2"
MA - 236 - 23 23,0 cm / 9"
MA - 236 - 28 28,0 cm / 11"

60°

MA - 237 - 16 16,0 cm / 6 1/4"
MA - 237 - 19 19,0 cm / 7 1/2"
MA - 237 - 23 23,0 cm / 9"
MA - 237 - 28 28,0 cm / 11"

DE BAKEY

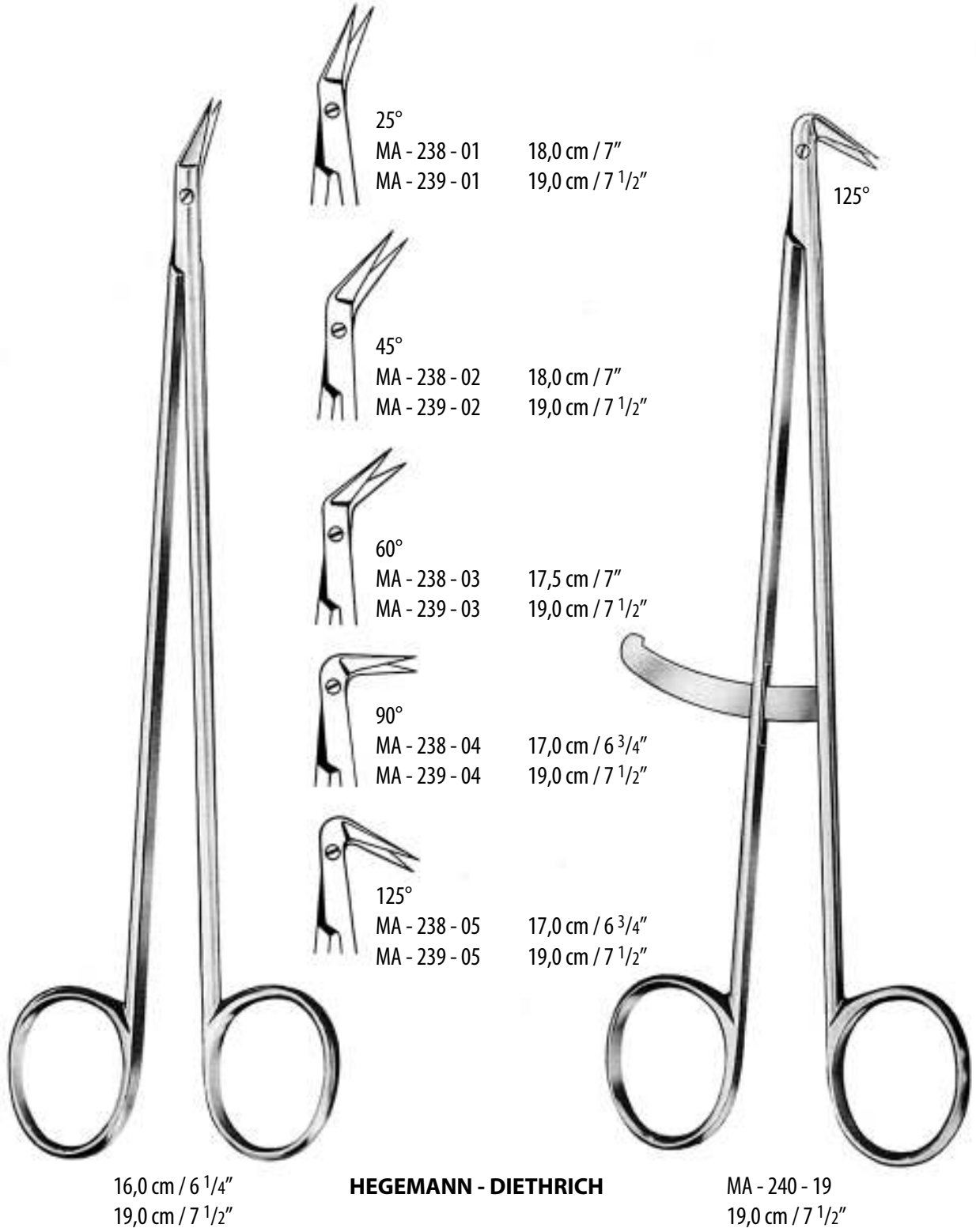

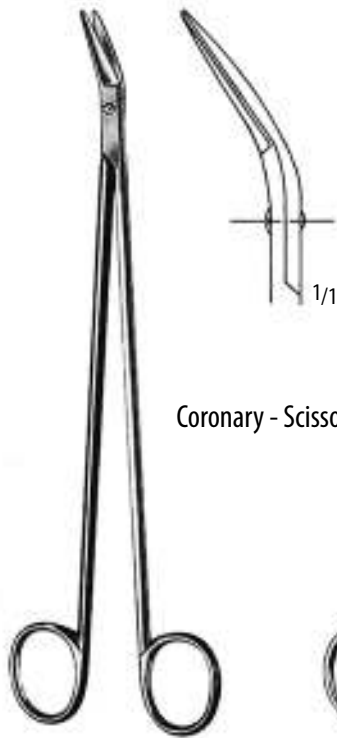

Coronary - Scissors

POTTS - SMITH
 MA - 241 - 19
 19,5 cm / 7 3/4"



MA - 242 - 11
 11,5 cm / 4 1/2"



MA - 243 - 14
 14,5 cm / 5 1/2"



MA - 244 - 14
 14,5 cm / 5 1/2"

probe pointed



STRULLY
 MA - 245 - 22 MA - 246 - 22
 22,0 cm / 8 3/4" 22,0 cm / 8 3/4"

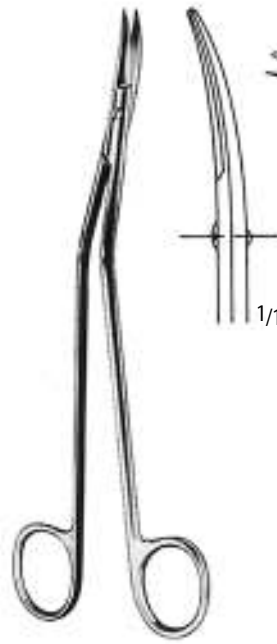

DANDY
 MA - 247 - 17
 17,0 cm / 6 3/4"

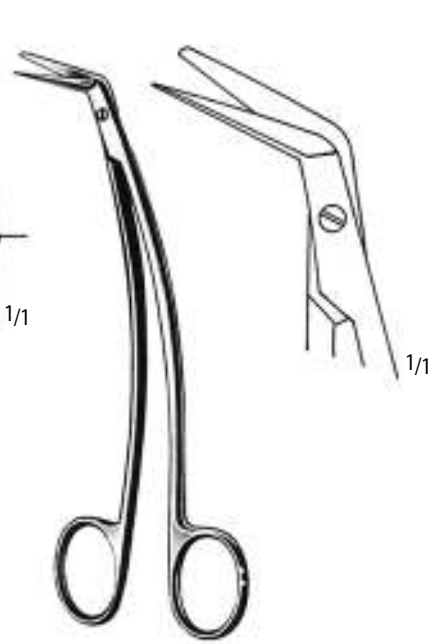

FAVALORO
 MA - 248 - 15
 15,0 cm / 6"

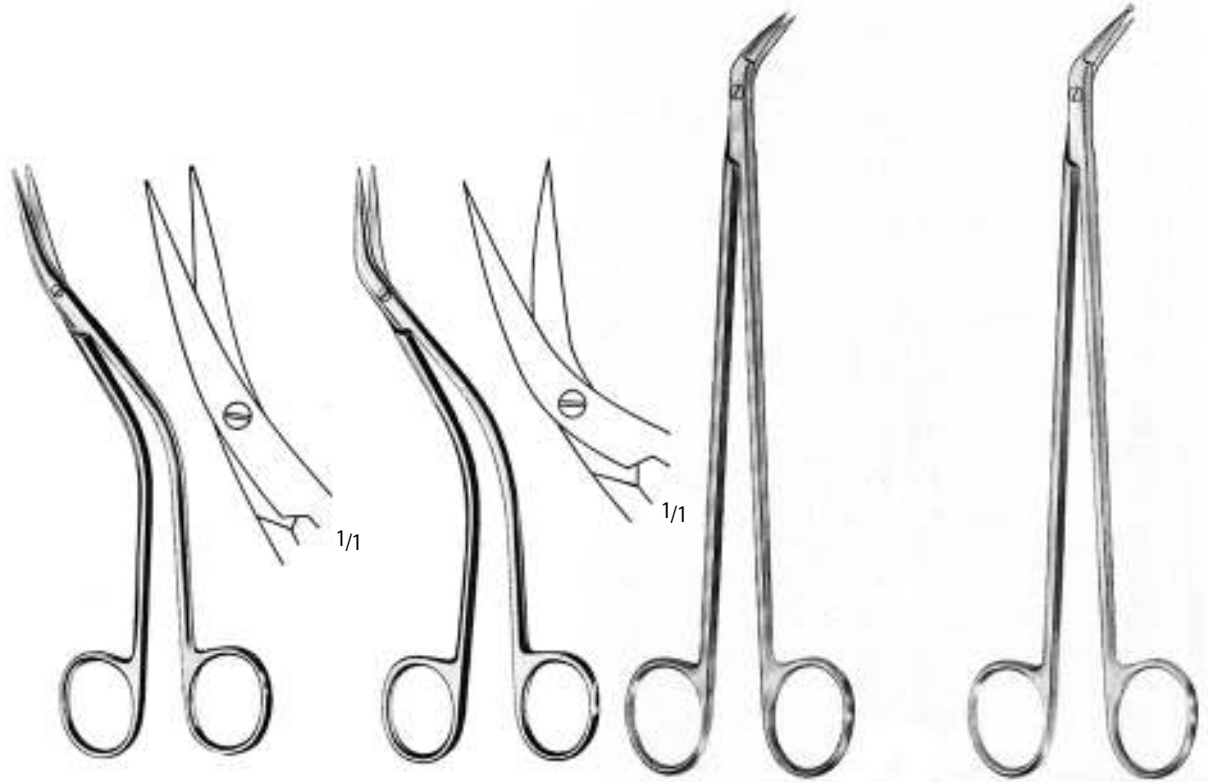

DE BAKEY

MA - 250 - 15
15,5 cm / 6"

MA - 251 - 15
15,5 cm / 6"

POTTS - DE MARTEL

MA - 252 - 21
21,0 cm / 8 1/4"

MILLS

MA - 253 - 21
21,0 cm / 8 1/4"

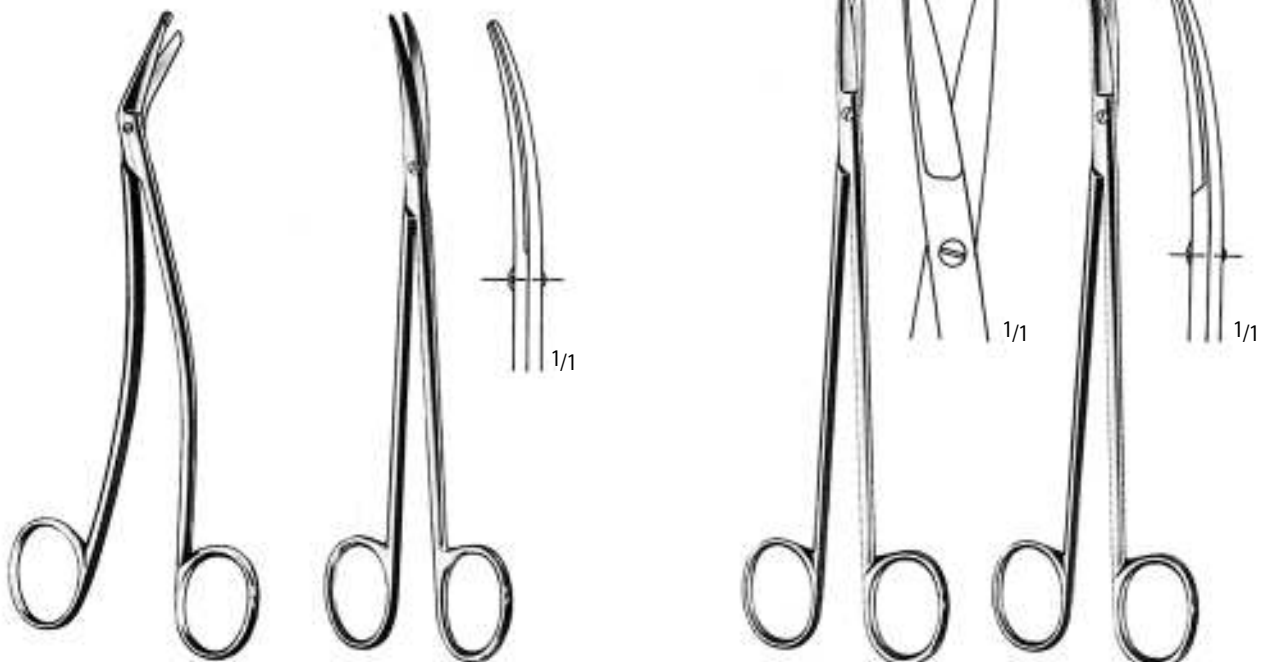

SCHMIEDEN - TAYLOR

14,5 cm / 5 1/2" MA - 254 - 15
17,0 cm / 6 3/4" MA - 254 - 17

TOENNIS - ADSON

MA - 255 - 17
17,5 cm / 7"

TOENNIS

MA - 256 - 18
18,0 cm / 7"

MA - 257 - 18
18,0 cm / 7"

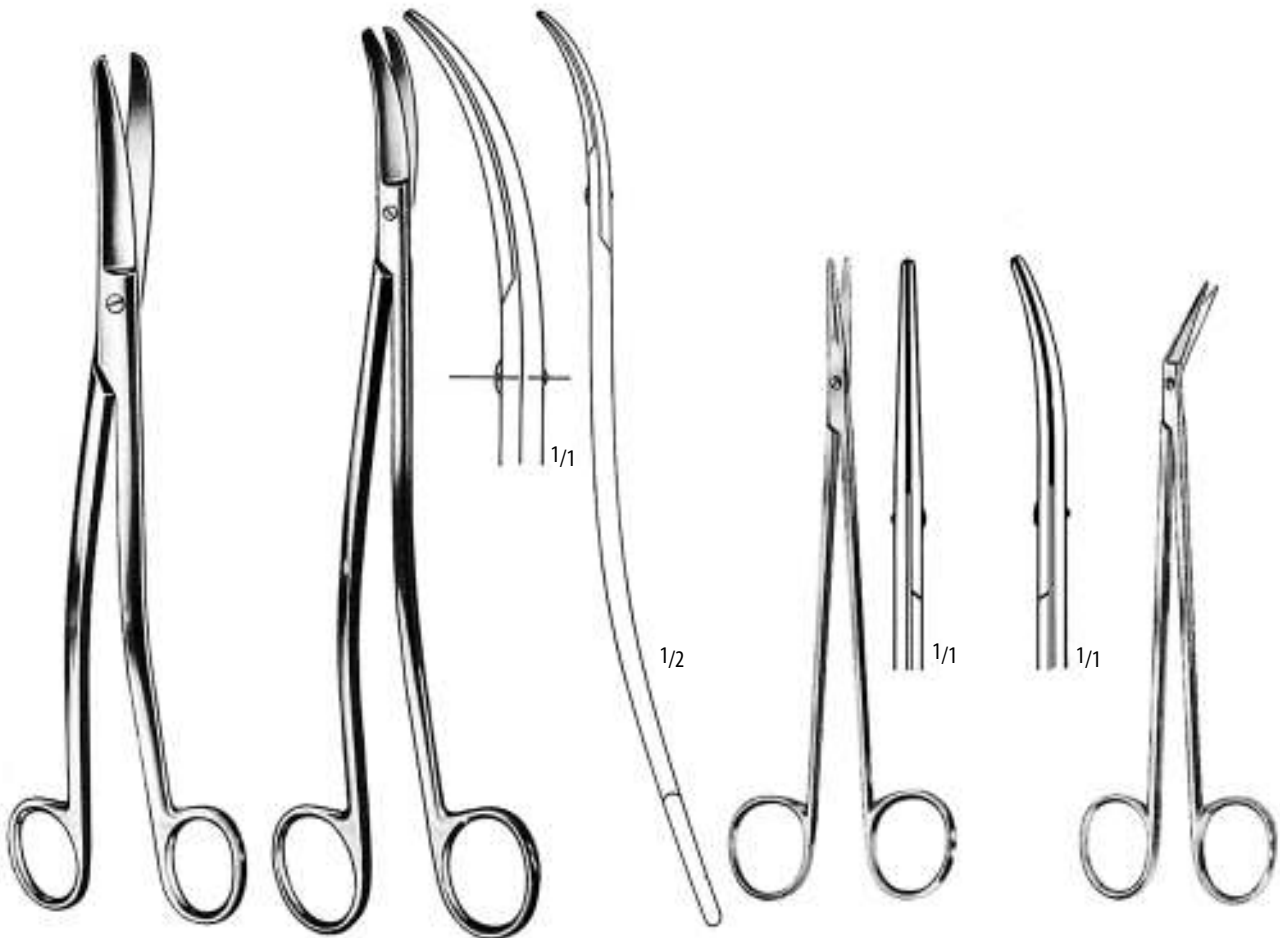

KLINKENBERGH - LOTH
MA - 301 - 23
23,0 cm / 9"

SATINSKY
MA - 302 - 24
24,5 cm / 10"

LINCOLN
MA - 304 - 17
17,0 cm / 6 3/4"

FULTON
MA - 305 - 17
17,0 cm / 6 3/4"

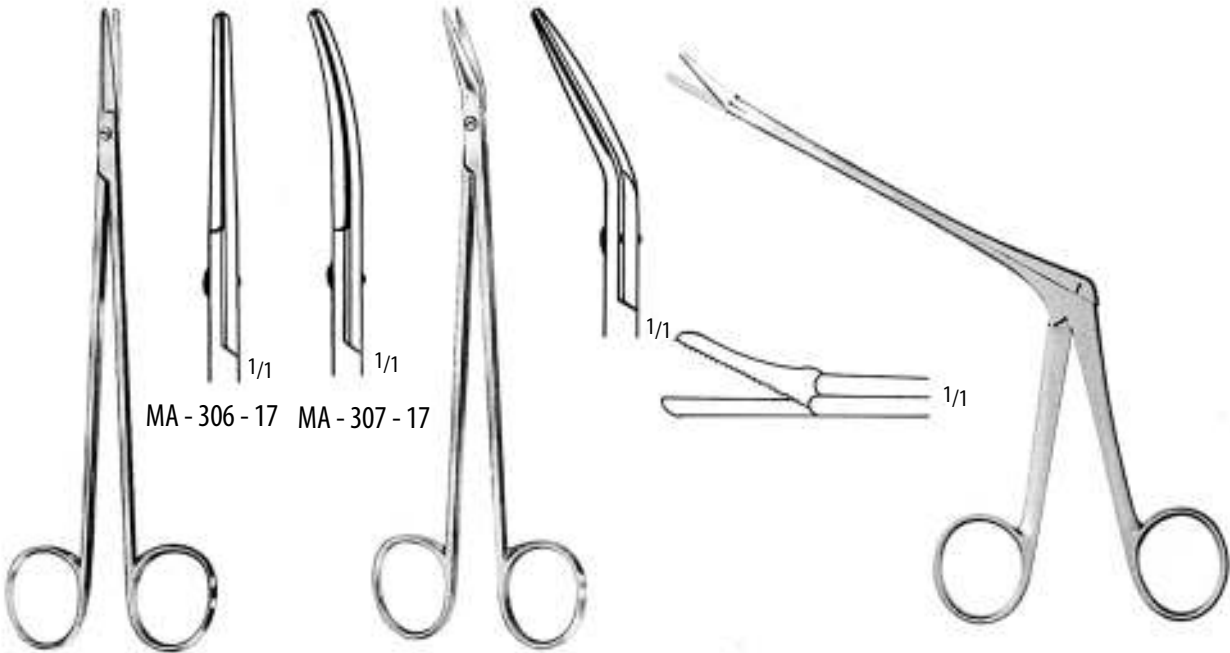

CHURCH
17,0 cm / 6 3/4"

CLASSON
MA - 308 - 17
17,0 cm / 6 3/4"

OLIVECRONA
MA - 309 - 23
23,0 cm / 9"

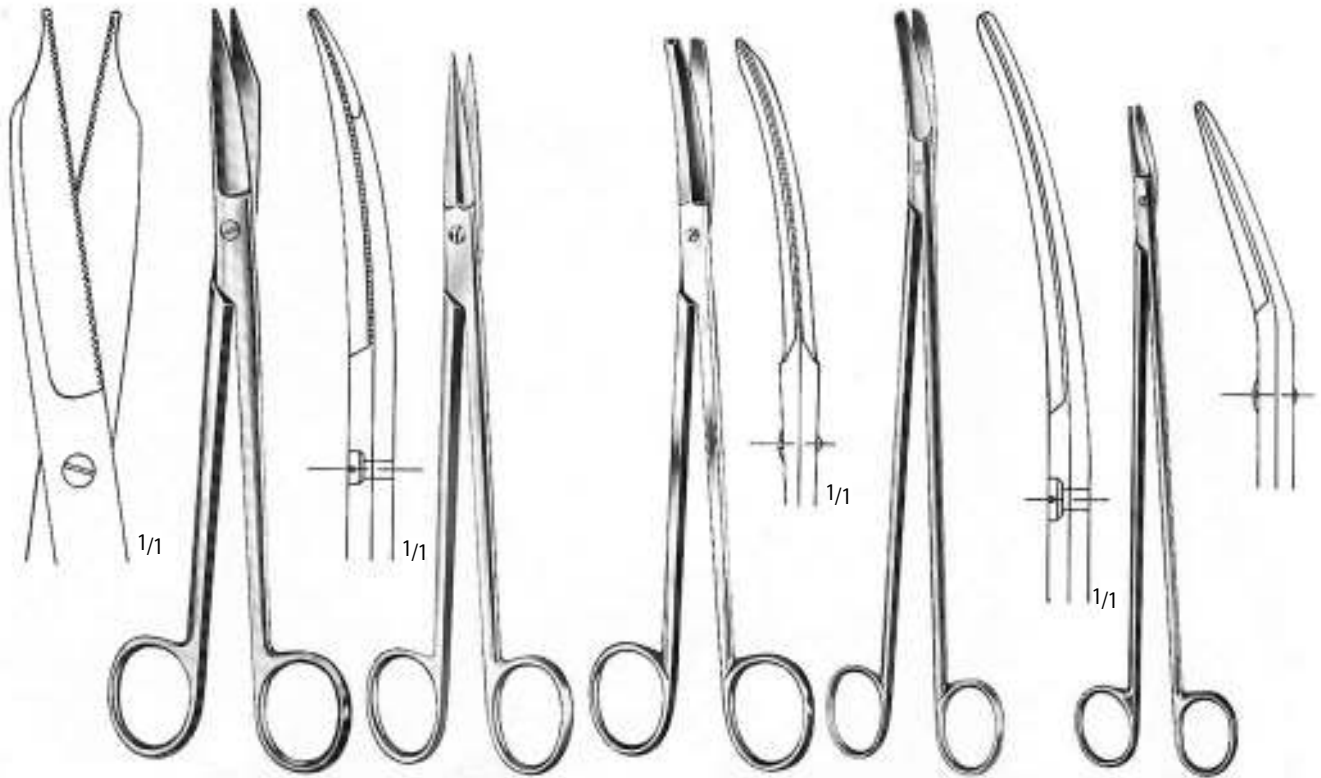

MARTIN - CARTILAGE

MA - 310 - 20
20,0 cm / 8"

MC INDOE

MA - 311 - 19
19,0 cm / 7 1/2"

POTTS - SMITH

MA - 312 - 19
19,0 cm / 7 1/2"

CRAFOORD

MA - 313 - 30
30,0 cm / 12"

FINOCHIETTO

MA - 314 - 27
27,0 cm / 10 1/4"



MA - 315 - 21
21,0 cm / 8 1/4"

MA - 316 - 21
21,0 cm / 8 1/4"

MA - 317 - 21
21,0 cm / 8 1/4"

MA - 320 - 11
MA - 320 - 13
MA - 320 - 14

11,0 cm / 4 1/4"
13,0 cm / 5"
14,0 cm / 5 1/2"

MA - 321 - 11
MA - 321 - 13
MA - 321 - 14



PRINCE
MA - 440 - 17
17,5 cm / 7"

BÖTTCHER
MA - 441 - 18
18,0 cm / 7"



GOOD
MA - 442 - 19
19,0 cm / 7 1/2"

GOOD - SCHWECKENDICK
MA - 443 - 19
19,0 cm / 7 1/2"

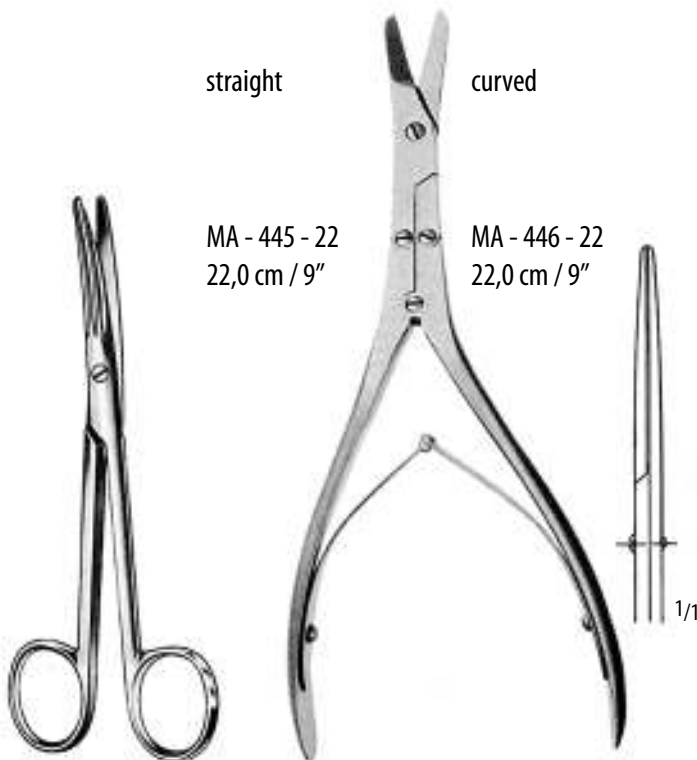

straight

curved

MA - 445 - 22
22,0 cm / 9"

MA - 446 - 22
22,0 cm / 9"

SCHOEMAKER
MA - 444 - 15
15,0 cm / 6"

CAPLAN



FOMON
MA - 447 - 13
13,5 cm / 5 1/4"

FOMON
MA - 448 - 13
13,5 cm / 5 1/4"

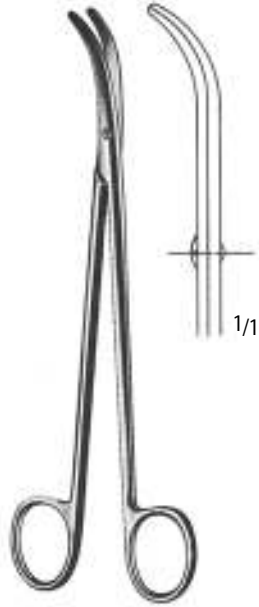

HALLE
MA - 449 - 19
19,0 cm / 7 1/2"



COTTLE
MA - 450 - 16
16,0 cm / 6 1/2"



HEYMANN
MA - 451 - 18
18,0 cm / 7"



HEYMANN
MA - 452 - 19
19,5 cm / 7 1/2"



BRAUN - STADLER
MA - 453 - 14
14,0 cm / 5 1/2"



BRAUN - STADLER
MA - 453 - 22
22,0 cm / 8 3/4"



WALDMANN
MA - 453 - 18
18,0 cm / 7"



MA - 454 - 20
20,0 cm / 8"



MARBACH
MA - 455 - 15
15,5 cm / 6"



MOD. USA
MA - 456 - 10
10,5 cm / 4"



SCHUMACHER
MA - 457 - 16
16,0 cm / 6 1/4"



BUSCH
13,0 cm / 5" MA - 458 - 13
16,0 cm / 6 1/4" MA - 458 - 16



WAGNER
12,0 cm / 4³/₄"

straight



Fig. 1
MA - 460 - 01



Fig. 2
MA - 460 - 02



Fig. 3
MA - 460 - 03

curved



Fig. 1
MA - 461 - 01



Fig. 2
MA - 461 - 02



Fig. 3
MA - 461 - 03



MA - 462 - 11
11,0 cm / 4¹/₄"



MA - 463 - 11
11,0 cm / 4¹/₄"

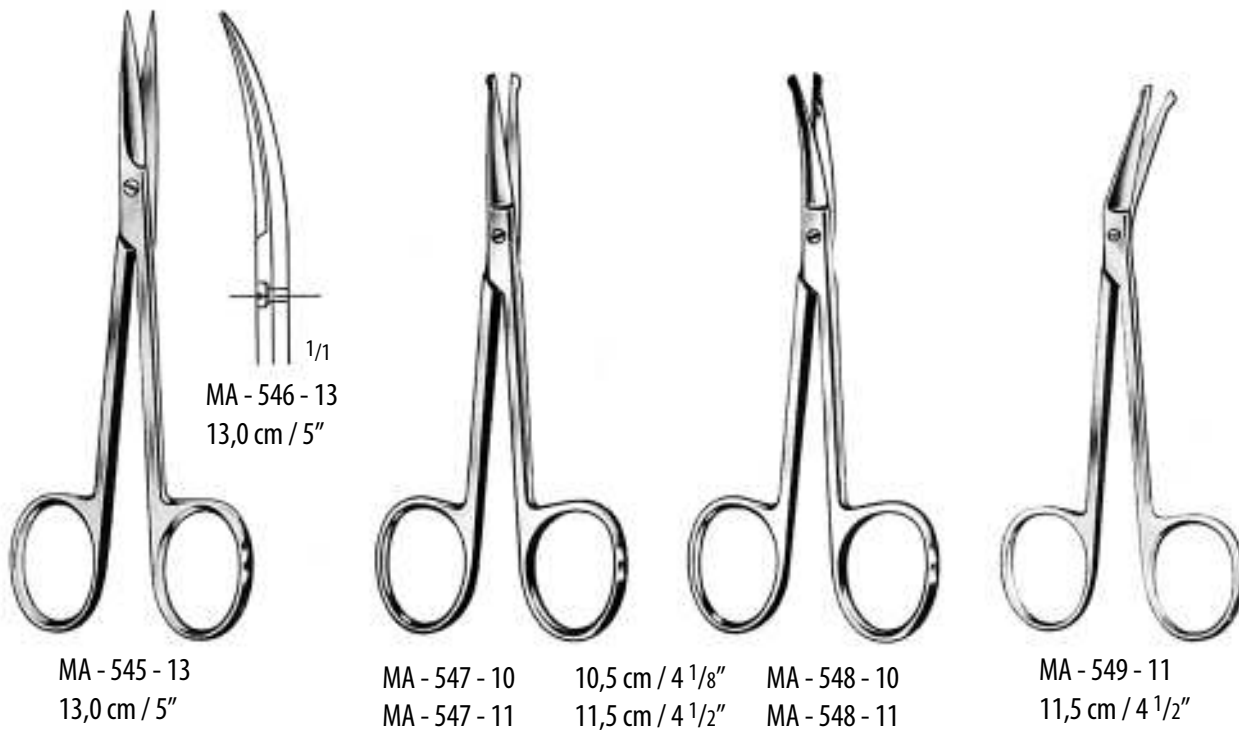
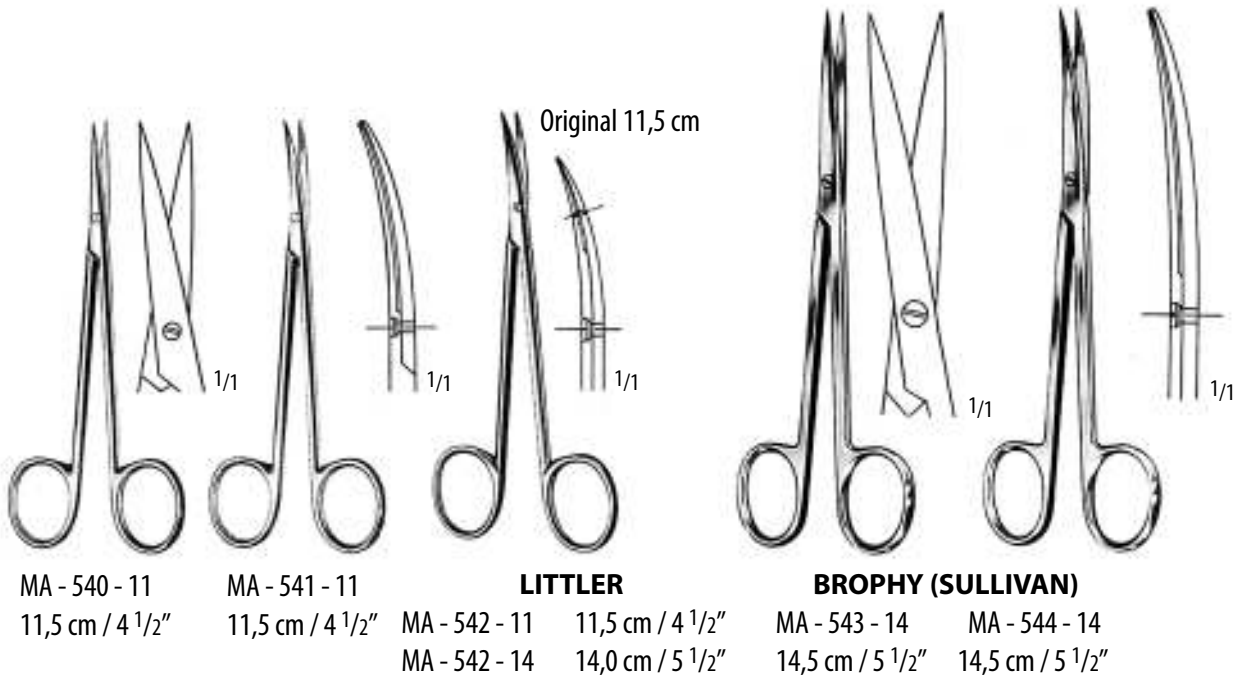

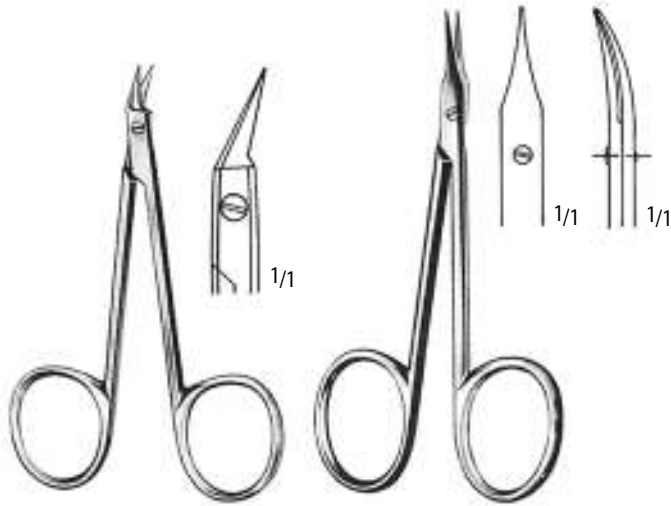

O'BRIEN

MA - 550 - 09
9,0 cm / 3 1/2"

WALTON

MA - 551 - 10
10,0 cm / 4"

extra delicate

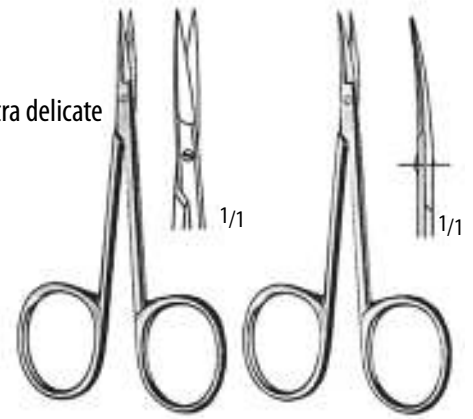

MOD. BONN

MA - 552 - 08
8,0 cm / 3 1/4"

MA - 553 - 08
8,0 cm / 3 1/4"



LANDOLT

MA - 554 - 12
12,5 cm / 5"

LANDOLT

MA - 555 - 12
12,5 cm / 5"

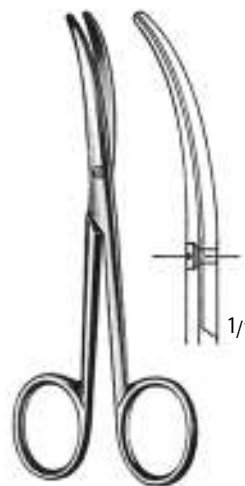

LANDOLT

MA - 556 - 12
12,5 cm / 5"



LANDOLT

MA - 557 - 12
12,5 cm / 5"

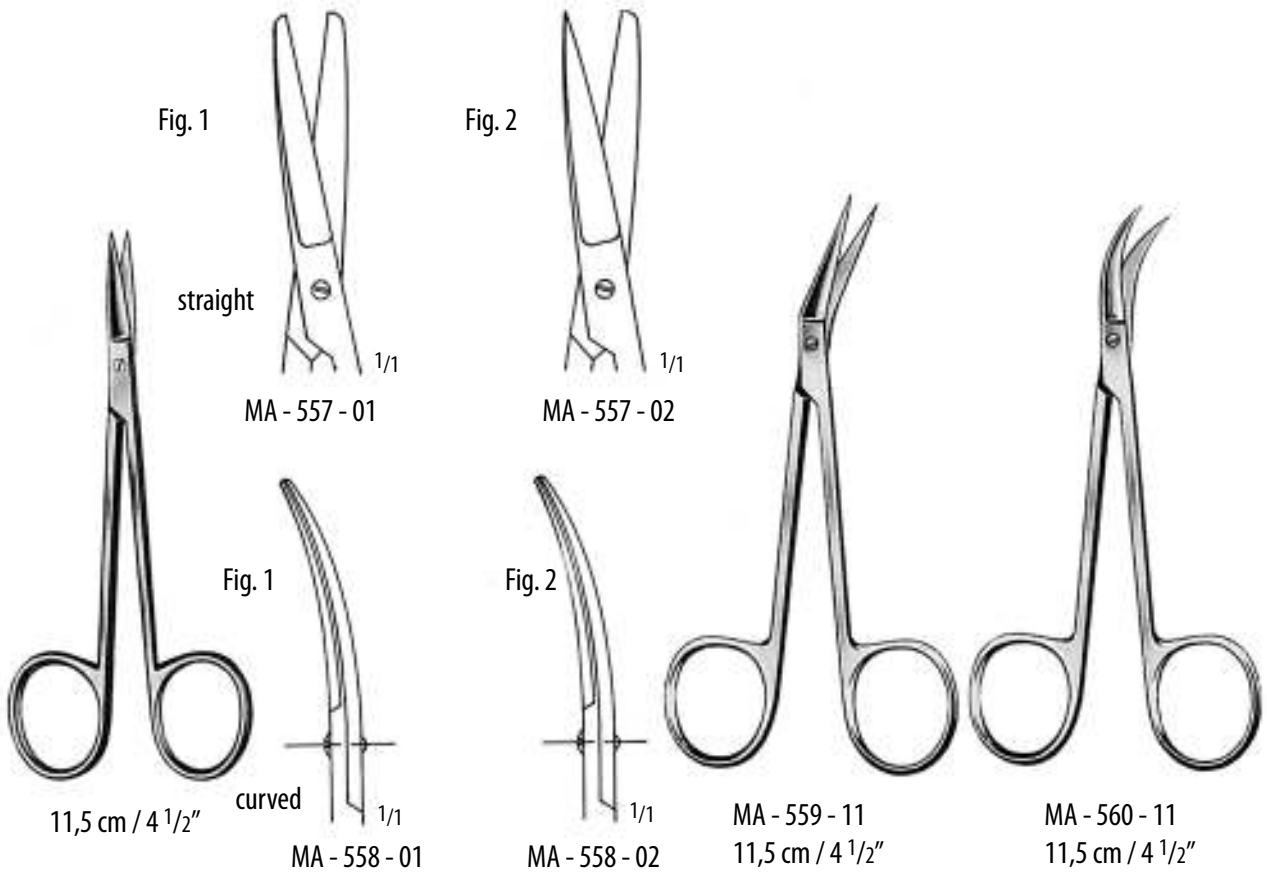

Iris Scissors



9,0 cm / 3 1/2"	MA - 561 - 09	MA - 562 - 09
10,5 cm / 4 1/4"	MA - 561 - 10	MA - 562 - 10
11,5 cm / 4 1/2"	MA - 561 - 11	MA - 562 - 11

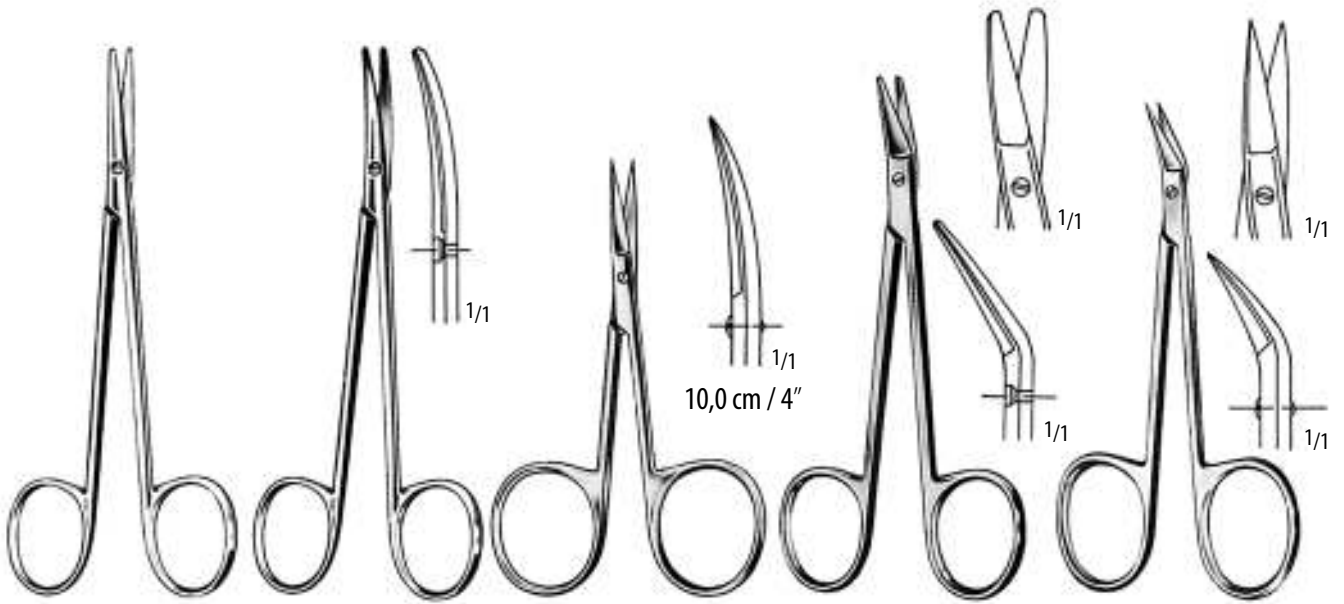

MA - 565 - 11
11,5 cm / 4 1/2"

MA - 566 - 11
11,5 cm / 4 1/2"

MA - 567 - 11
10,0 cm / 4"

GRAEFE
MA - 569 - 10
10,5 cm / 4 1/4"

WILMER
MA - 570 - 10
10,0 cm / 4"

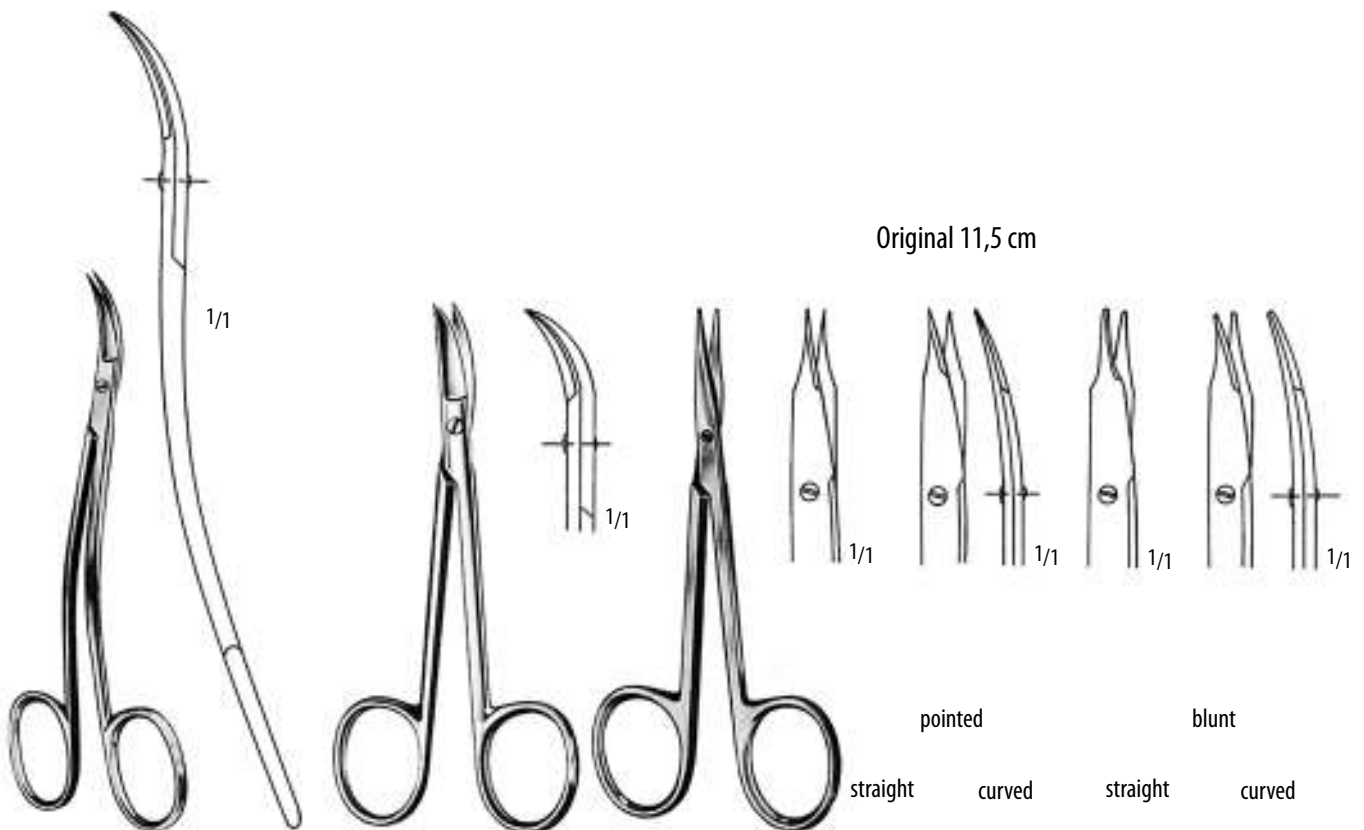

Original 11,5 cm

pointed blunt
straight curved straight curved

LA GRANGE
MA - 571 - 11
11,5 cm / 4 1/2"

CHADWICK
MA - 572 - 11
11,0 cm / 4 1/4"

STEVENS
10,5 cm / 4 1/8"
11,5 cm / 4 1/2"

MA-573-10 MA-574-10 MA-575-10 MA-576-10
MA-573-11 MA-574-11 MA-575-11 MA-576-11

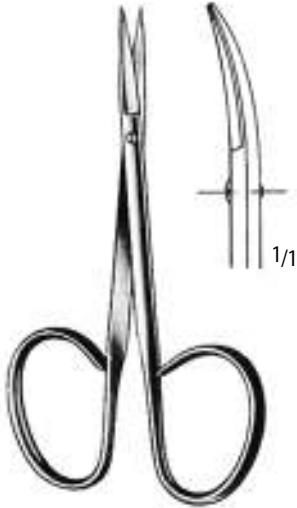

straight curved

10,0 cm / 4"

MA - 577 - 10 MA - 578 - 10



straight curved

10,0 cm / 4"

MA - 579 - 10 MA - 580 - 10

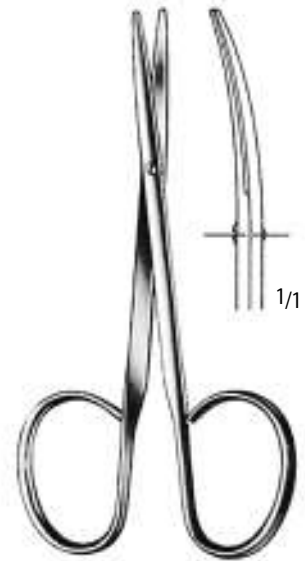

straight curved

10,0 cm / 4"

MA - 581 - 10 MA - 582 - 10

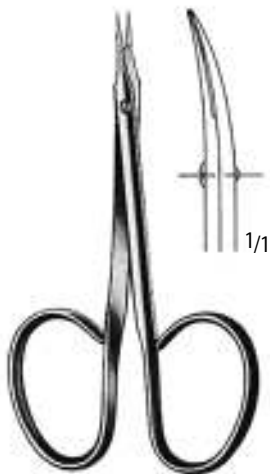

straight curved

9,5 cm / 3 3/4"

MA - 583 - 09 MA - 584 - 09

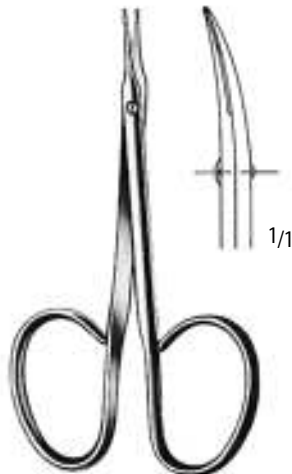

straight curved

9,5 cm / 3 3/4"

MA - 585 - 09 MA - 586 - 09

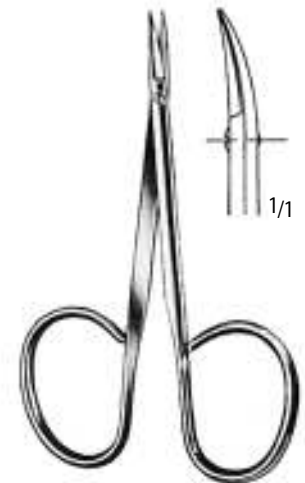

straight curved

9,5 cm / 3 3/4"

MA - 587 - 09 MA - 588 - 09



SPENCER

9,0 cm / 3 1/2" MA - 589 - 09
10,5 cm / 4 1/4" MA - 589 - 10
12,5 cm / 4 3/4" MA - 589 - 13



SPENCER - DELICATE

MA - 590 - 11
11,0 cm / 4 1/4"



LITTAUER

MA - 591 - 14
14,0 cm / 5 1/2"



MA - 592 - 16
16,0 cm / 6 1/4"



EISELSBERG
MA - 593 - 12
11,0 cm / 4 1/4"



SCHOEMAKER - LOTH
MA - 594 - 12
12,5 cm / 5"



MA - 595 - 11
11,5 cm / 4 1/2"

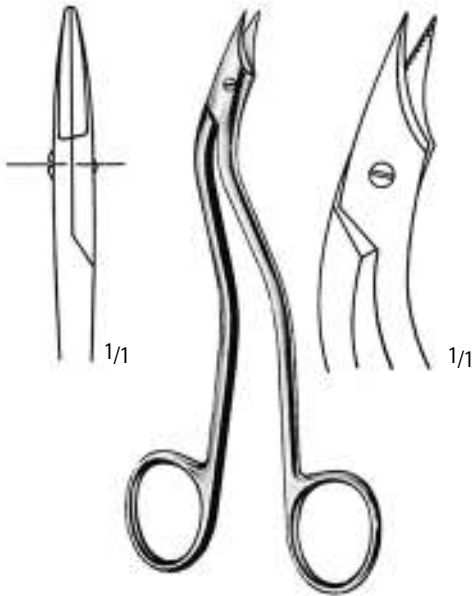

HEATH
MA - 596 - 15
15,0 cm / 6"



MA - 597 - 12
12,0 cm / 4 ³/₄"



SHORTBENT
MA - 598 - 09
9,0 cm / 3 ¹/₂"



NORTHBENT
MA - 599 - 12
12,5 cm / 5"



BUCK
14,5 cm / 5 ¹/₂" MA - 600 - 14
18,0 cm / 7" MA - 600 - 18



HARVEY
MA - 601 - 12
12,5 cm / 5"



SCHUKNECHT
MA - 602 - 10
10,0 cm / 4"

MA - 603 - 11
11,0 cm / 4 1/2"



UNIVERSAL
MA - 604 - 12
12,0 cm / 4 3/4"



SMITH
MA - 605 - 17
17,5 cm / 7"

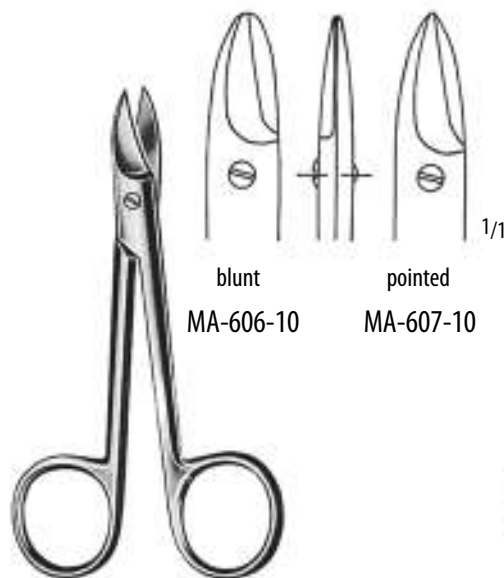

BEEBEE
10,5 cm / 4"
straight

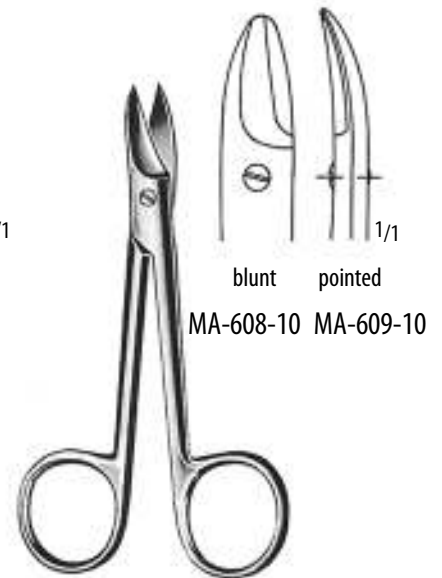

BEEBEE
10,5 cm / 4"
curved

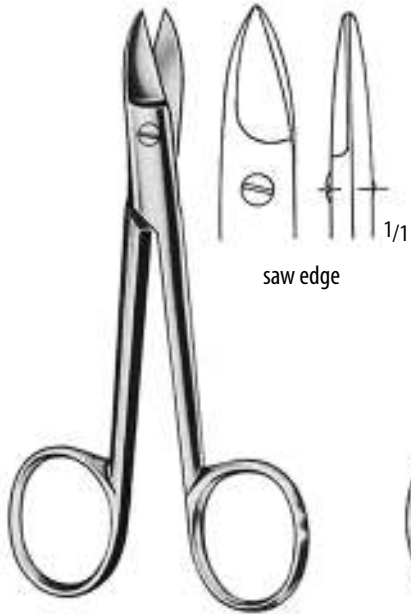

BEEBEE
MA - 610 - 12
12,0 cm / 4 3/4"

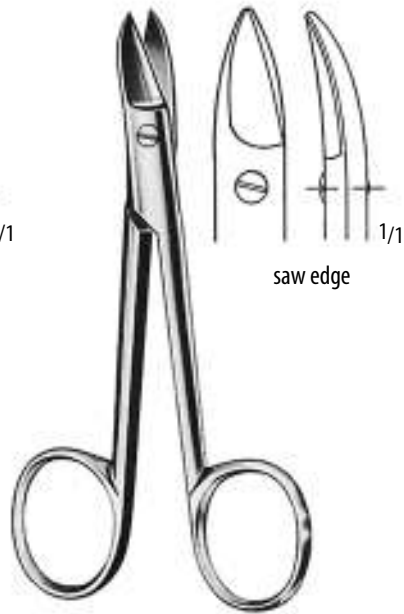

BEEBEE
MA - 611 - 12
12,0 cm / 4 3/4"



MA - 612 - 10
10,5 cm / 4"



MA - 613 - 09
9,0 cm / 3 1/2"



MA - 614 - 09
9,0 cm / 3 1/2"



MA - 615 - 11
11,0 cm / 4 1/2"



MA - 616 - 11
11,0 cm / 4 1/2"



MA - 617 - 14
14,5 cm / 5 3/4"



MA - 618 - 16
16,0 cm / 6 1/4"



143° C / 290° F
autoclavable

UNIVERSAL
MA - 619 - 18
18,0 cm / 7"



BERGMANN
MA - 620 - 23
23,0 cm / 9"



LANGE
MA - 621 - 18
18,0 cm / 7"



saw edge

MA - 622 - 17
17,0 cm / 6 1/2"

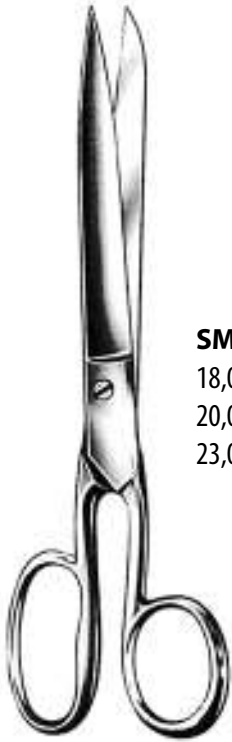

SMITH (Mod. USA)

18,0 cm / 7" MA - 630 - 18
 20,0 cm / 8" MA - 630 - 20
 23,0 cm / 9" MA - 630 - 23



LORENZ

MA - 631 - 23
 23,0 cm / 9"



KNOWLES

MA - 632 - 14
 14,0 cm / 5 1/2"



for fingers

KNOWLES

MA - 633 - 14
 14,0 cm / 5 1/2"



LISTER

18,5 cm / 7 1/4" MA - 634 - 18
 21,0 cm / 8 1/4" MA - 634 - 21



saw edge

LISTER - EXCENTRIC

16,0 cm / 6 1/4" MA - 635 - 16
 19,0 cm / 7 1/2" MA - 635 - 19

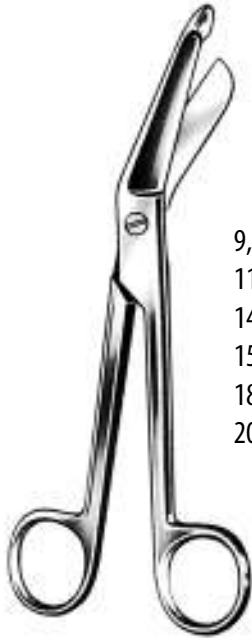

9,0 cm / 3 1/2"	MA - 636 - 09
11,0 cm / 4 1/2"	MA - 636 - 11
14,0 cm / 5 1/2"	MA - 636 - 14
15,5 cm / 6"	MA - 636 - 15
18,0 cm / 7"	MA - 636 - 18
20,0 cm / 8"	MA - 636 - 20

LISTER



20,0 cm / 8"	MA - 637 - 20
22,0 cm / 8 3/4"	MA - 637 - 22

ESMARCH



SEUTIN
MA - 638 - 23
23,0 cm / 9"



saw edge

MA - 639 - 20
20,0 cm / 8"

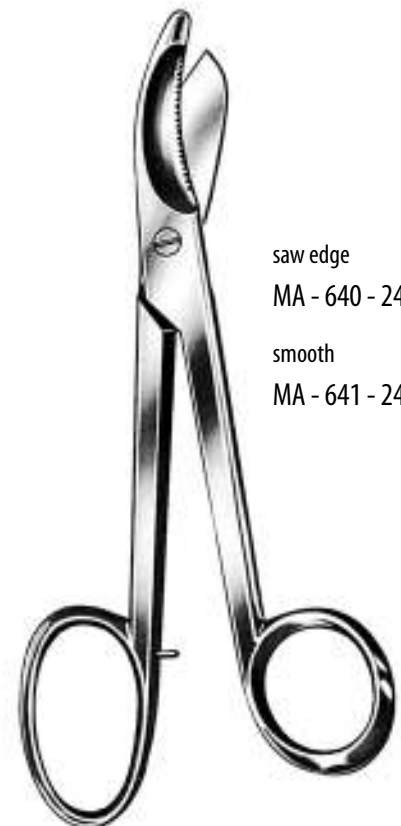

saw edge
MA - 640 - 24
smooth
MA - 641 - 24

BRUNS
24,0 cm / 9 1/2"



9,0 cm / 3 1/2" MA - 701 - 09
10,5 cm / 4 1/4" MA - 701 - 10

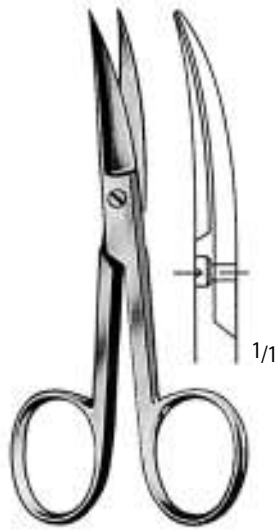

MA - 702 - 09
MA - 702 - 10



MA - 703 - 09
MA - 703 - 10

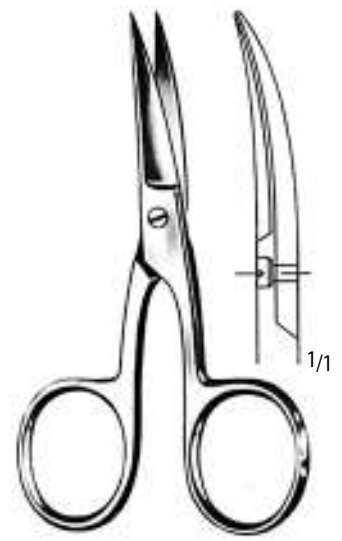

MA - 704 - 09
MA - 704 - 10

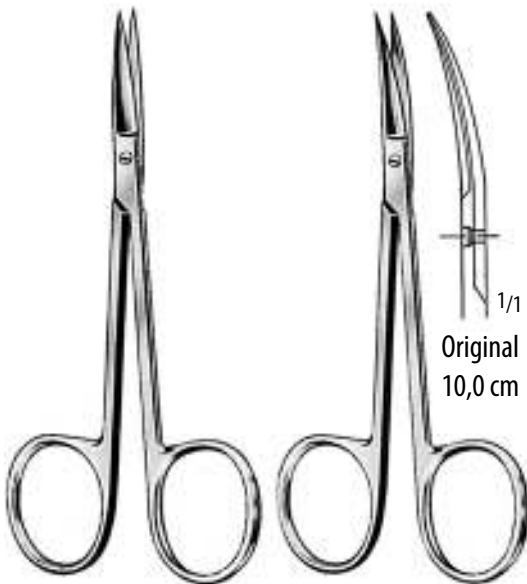

MA - 705 - 10 10,0 cm / 4" MA - 706 - 10
MA - 705 - 11 11,0 cm / 4 1/4" MA - 706 - 11



MA - 707 - 11
10,5 cm / 4 1/4"



MA - 708 - 11
10,5 cm / 4 1/4"



KÖNIG
MA - 709 - 13 13,0 cm / 5"
MA - 709 - 15 15,0 cm / 6"

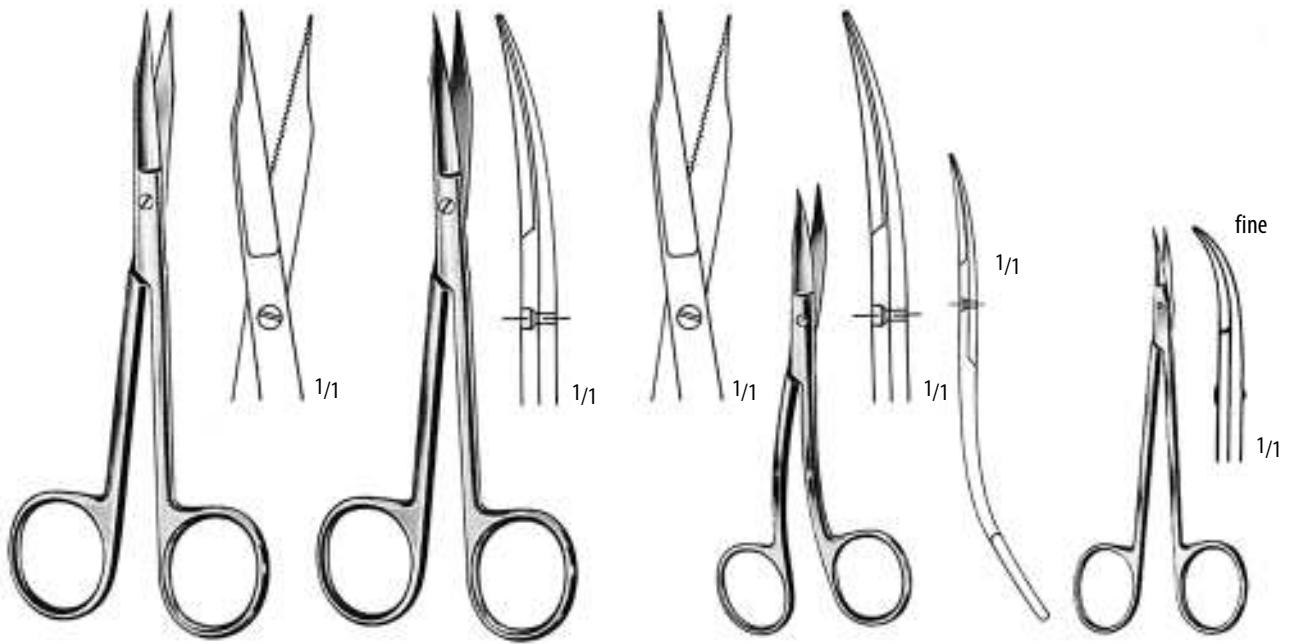

GOLDMAN - FOX

MA - 710 - 13 MA - 711 - 13
13,0 cm / 5" 13,0 cm / 5"

**GOLDMAN - FOX
(SPEZIAL)**

MA - 712 - 13 MA - 713 - 11
13,0 cm / 5" 11,5 cm / 4 1/2"

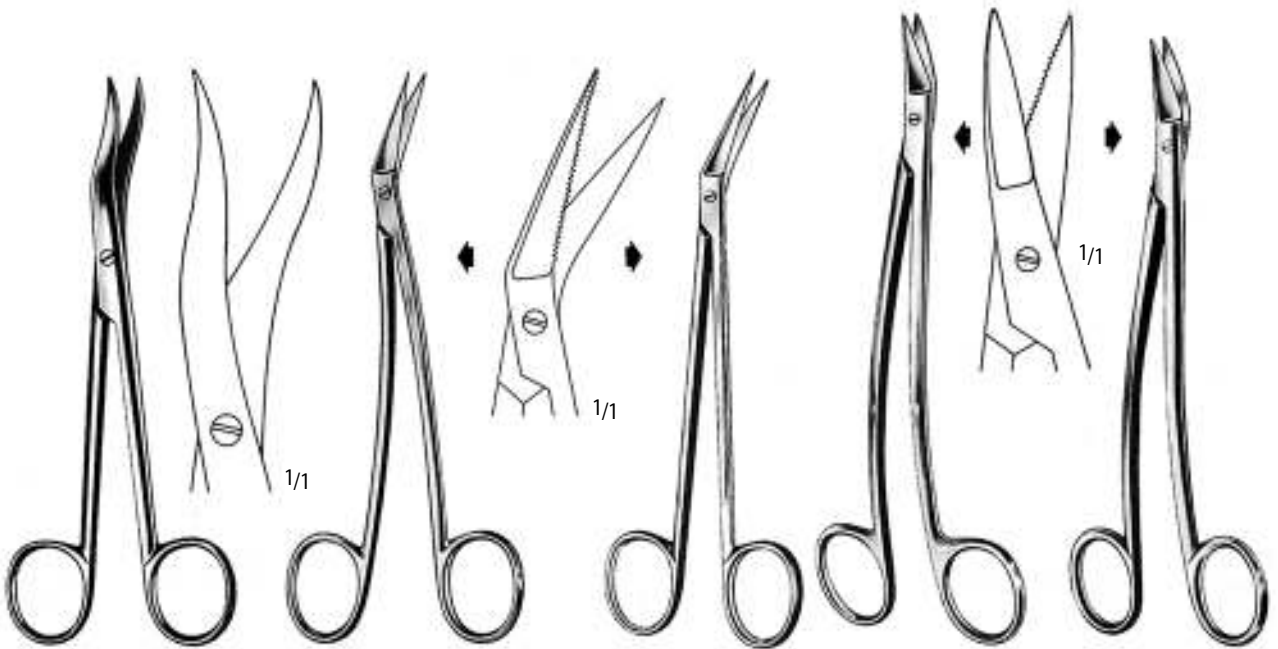

MA - 714 - 16
16,0 cm / 6 1/4"

LOCKLIN
MA - 715 - 16
16,5 cm / 6 1/2"

LOCKLIN
MA - 716 - 16
16,5 cm / 6 1/2"

DEAN - DELICATE
MA - 717 - 17
17,0 cm / 6 3/4"

DEAN
MA - 718 - 17
17,0 cm / 6 3/4"



QUINBY

MA - 719 - 12 MA - 720 - 12
12,0 cm / 4 3/4" 12,0 cm / 4 3/4"



STANDARD

MA - 721 - 11 MA - 722 - 11
11,0 cm / 4 1/2" 11,0 cm / 4 1/2"

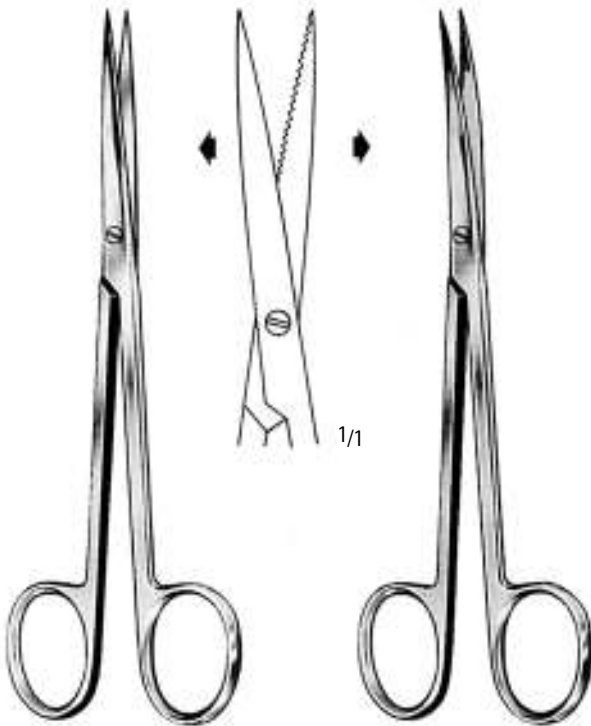

SULLIVAN

MA - 723 - 14 MA - 724 - 14
14,5 cm / 5 3/4" 14,5 cm / 5 3/4"



NEUMANN

MA - 725 - 12
12,5 cm / 5"



Fig. 1



Fig. 1



Fig. 1



NOYES

12,0 cm / 4 3/4"

- Fig. 1 MA - 900 - 12
- Fig. 2 MA - 902 - 12
- Fig. 3 MA - 904 - 12



- Fig. 1 MA - 901 - 12
- Fig. 2 MA - 903 - 12
- Fig. 3 MA - 906 - 12



MA - 906 - 11



MA - 907 - 11



MA - 908 - 11



BARRAQUER

5,5 cm / 2 1/4"

5 mm MA-909-05

7 mm MA-909-07

10 mm MA-909-10

WECKER

11,0 cm / 4 1/2"



CASTROVIEJO

MA - 915 - 01
9,0 cm / 3 1/2"



MA - 910 - 02

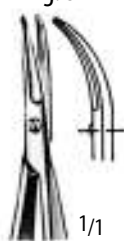

MA - 910 - 03



MA - 911 - 09



MA - 912 - 09



CASTROVIEJO

10,0 cm / 4"



CASTROVIEJO

10,0 cm / 4"



straight

1/1

MA - 916 - 01
8,5 cm / 3 1/2"



curved

1/1

VANNAS MOD. TÜBINGEN
MA - 916 - 02 MA - 916 - 03
8,5 cm / 3 1/2" 8,5 cm / 3 1/2"



angular

1/1

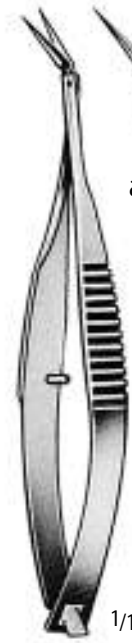

angled on flat

1/1

MA - 916 - 04
8,5 cm / 3 1/2"



straight

1/1

VANNAS
MA - 917 - 01
8,0 cm / 3 1/4"



curved

1/1

VANNAS
MA - 917 - 02
8,0 cm / 3 1/4"



angular

1/1

VANNAS
MA - 917 - 03
8,0 cm / 3 1/4"



angled on flat

1/1

VANNAS
MA - 917 - 04
8,0 cm / 3 1/4"



1/1
WESTCOTT
MA - 916 - 01
11,0 cm / 4 1/2"



1/1
WESTCOTT
MA - 916 - 02
11,0 cm / 4 1/2"



1/1
CASTROVIEJO
MA - 916 - 03
10,0 cm / 4"



1/1
CASTROVIEJO
MA - 916 - 04
10,0 cm / 4"

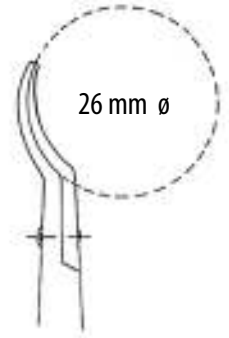

1/1
CASTROVIEJO
MA - 917 - 01
11,0 cm / 4 1/2"



1/1
CASTROVIEJO
MA - 917 - 02
11,0 cm / 4 1/2"



1/1
TROUTMAN
MA - 917 - 03
10,0 cm / 4"



1/1
TROUTMAN
MA - 917 - 04
10,0 cm / 4"



KATZIN
MA - 923 - 01
10,0 cm / 4"



KATZIN
MA - 923 - 02
10,0 cm / 4"



KATZIN
MA - 924 - 01
11,0 cm / 4 1/2"



KATZIN
MA - 924 - 02
11,0 cm / 4 1/2"

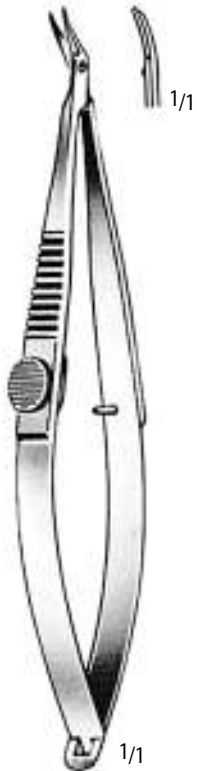

KATZIN - BARRAQUER
MA - 925 - 01 MA - 925 - 02
10,0 cm / 4" 10,0 cm / 4"



MA - 926 - 01
10,0 cm / 4"



MA - 926 - 02
10,0 cm / 4"



MA - 927 - 12
12,0 cm / 4³/₄"

1/1



NOYES
MA - 928 - 15
15,0 cm / 6"

1/1



WESTCOTT
MA - 929 - 01
11,5 cm / 4¹/₂"

1/1



WESTCOTT
MA - 929 - 02
11,5 cm / 4¹/₂"

1/1

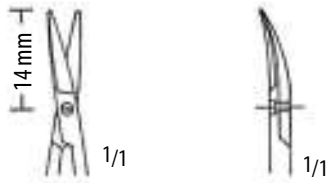

Dissection
MA - 950 - 15

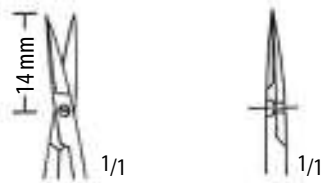

Adventitia
MA - 951 - 15

14,5 cm / 5 1/2"

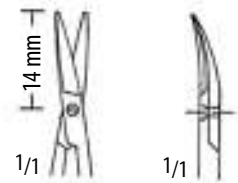

Dissection
MA - 950 - 18

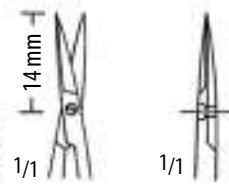

Adventitia
MA - 951 - 18

18,0 cm / 7"

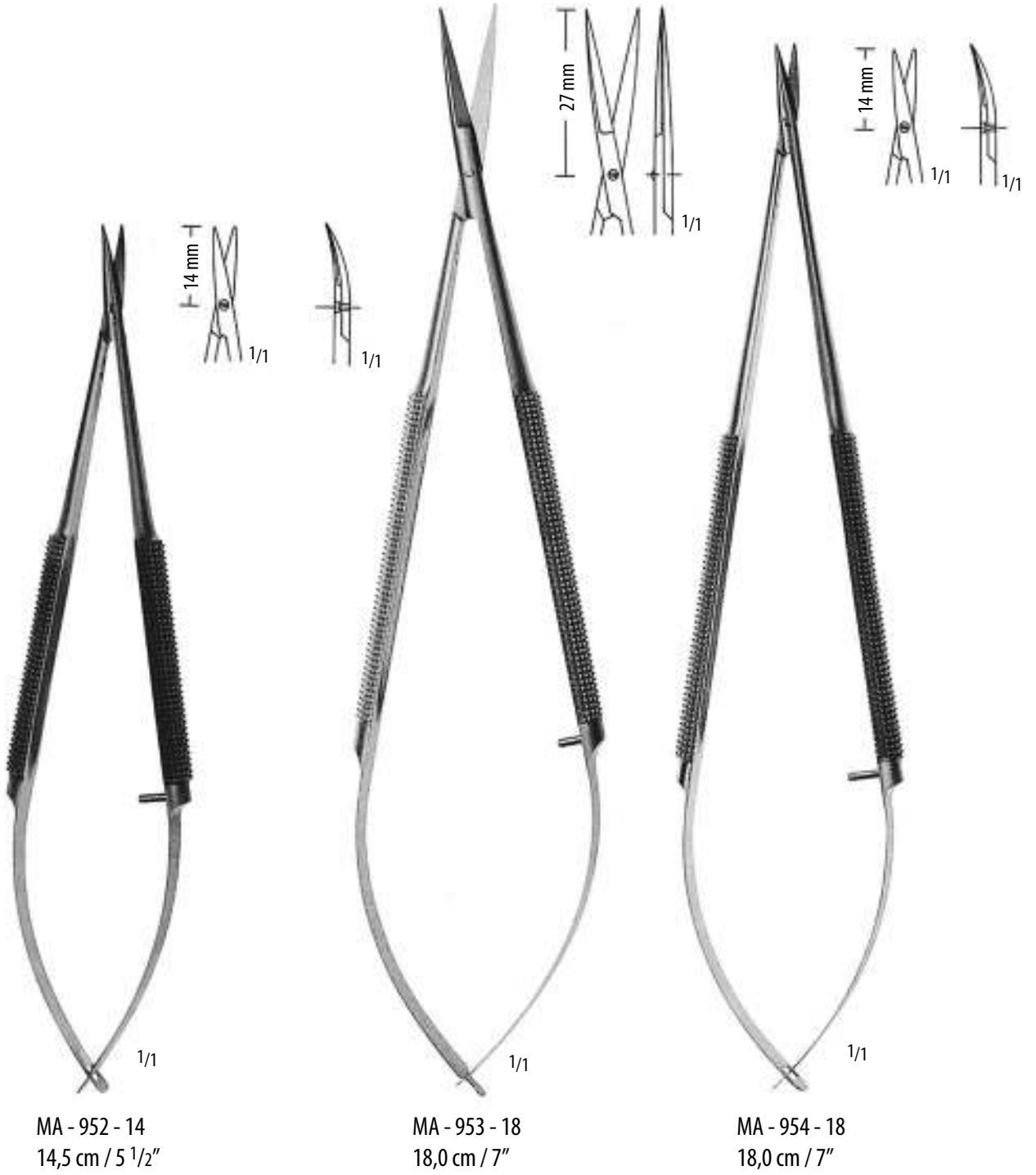

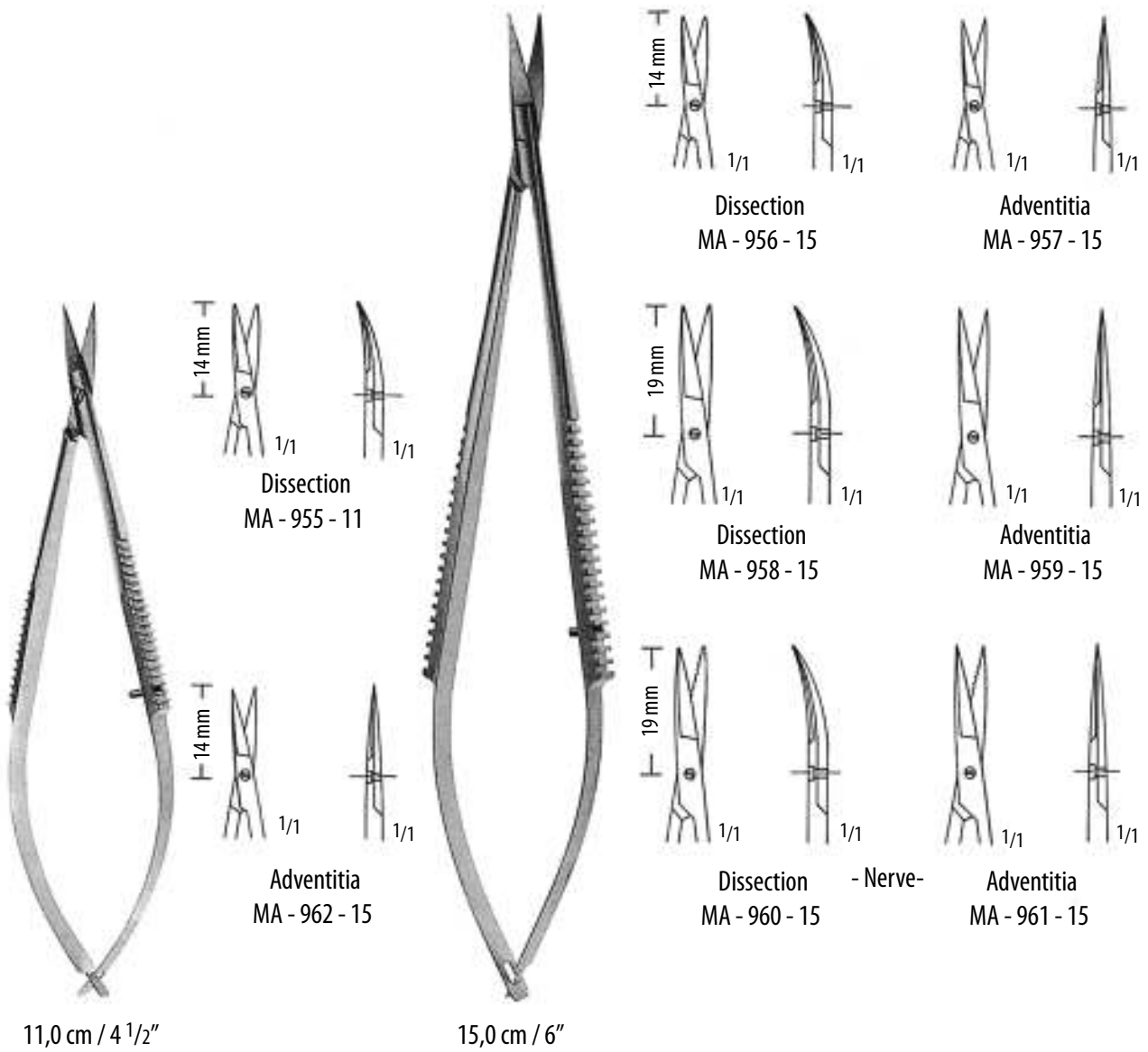



18,5 cm / 7 1/4"

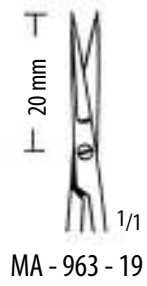

16,0 cm / 6 1/4"
19,0 cm / 7 1/2"
22,5 cm / 9"





18,0 cm / 7"

1/1

MA - 969 - 01
25°



MA - 969 - 02
45°



MA - 969 - 03
60°



MA - 969 - 04
90°



MA - 969 - 05
125°



1/1

MA - 970 - 01
25°



MA - 970 - 02
45°



MA - 970 - 03
60°



MA - 970 - 04
90°



MA - 970 - 05
125°



1/2

18,0 cm / 7"

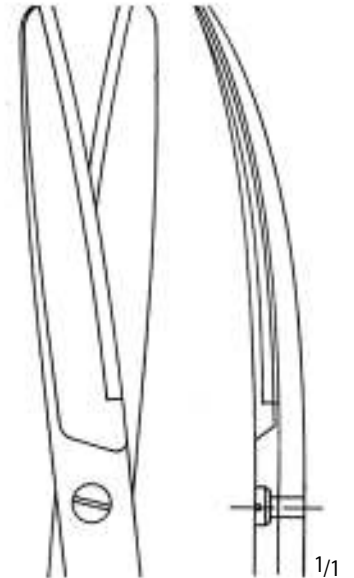
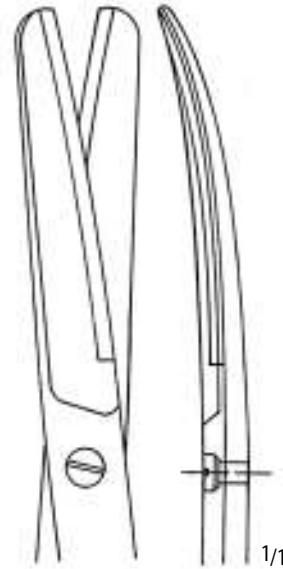
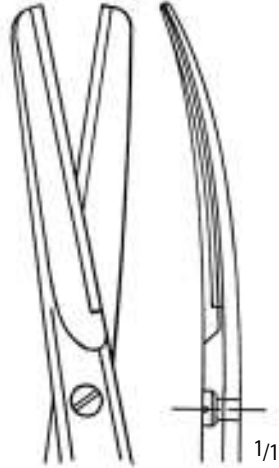

STANDARD
Fig. 1

14,5 cm / 5 1/2"
straight : MA - 850 - 14
curved : MA - 851 - 14

16,5 cm / 6 1/2"
MA - 850 - 16
MA - 851 - 16

18,5 cm / 7 1/4"
MA - 850 - 18
MA - 851 - 18

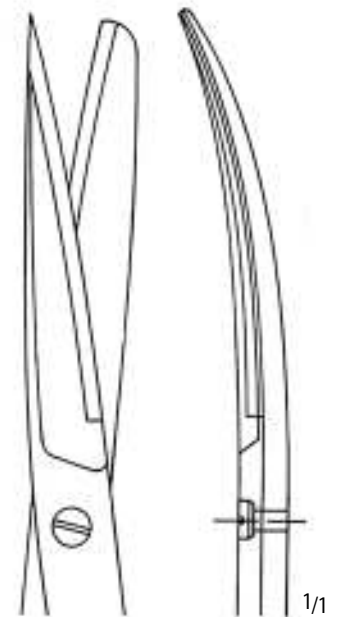
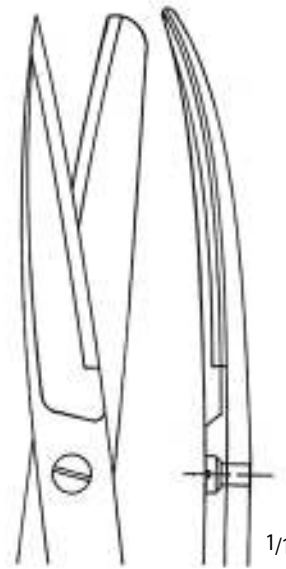
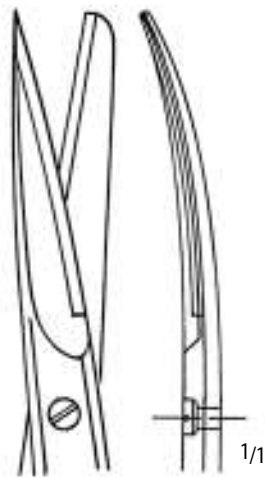

STANDARD
Fig. 2

14,5 cm / 5 1/2"
straight : MA - 852 - 14
curved : MA - 853 - 14

16,5 cm / 6 1/2"
MA - 852 - 16
MA - 853 - 16

18,5 cm / 7 1/4"
MA - 852 - 18
MA - 853 - 18

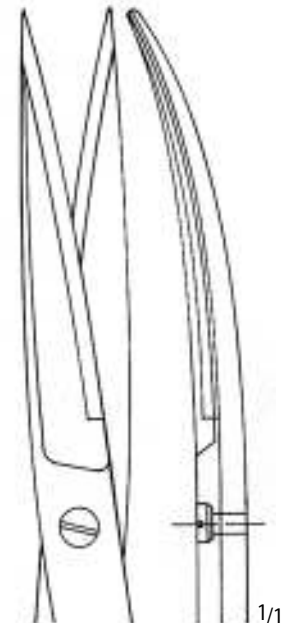
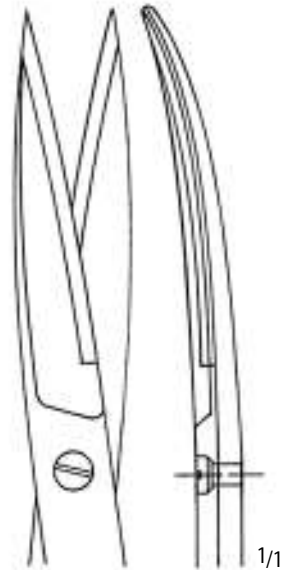
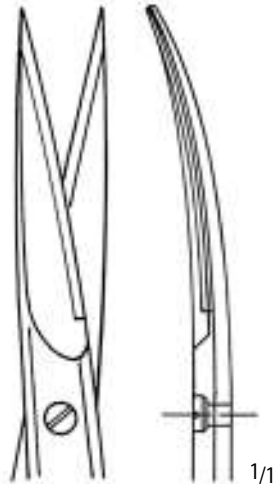

STANDARD
Fig. 3

14,5 cm / 5 1/2"
straight : MA - 854 - 14
curved : MA - 855 - 14

16,5 cm / 6 1/2"
MA - 854 - 16
MA - 855 - 16

18,5 cm / 7 1/4"
MA - 854 - 18
MA - 855 - 18

straight

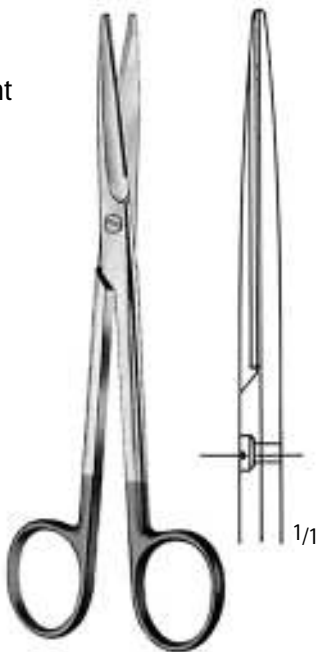

MAYO
MA - 856 - 14
MA - 856 - 17
MA - 856 - 23



Original 17,0 cm

14,5 cm / 5 1/2"
17,0 cm / 6 3/4"
23,0 cm / 9"



curved



MAYO
MA - 857 - 14
MA - 857 - 17
MA - 857 - 23

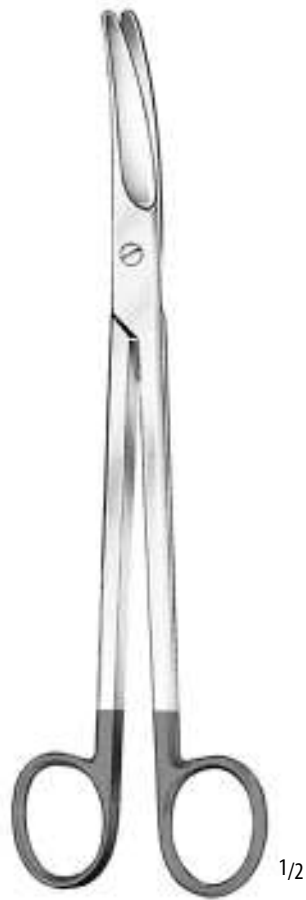

PARAMETRIUM

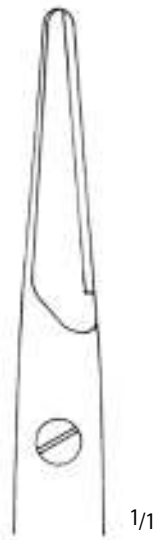

1/1



1/1

MA - 858 - 01
22,5 cm / 9"

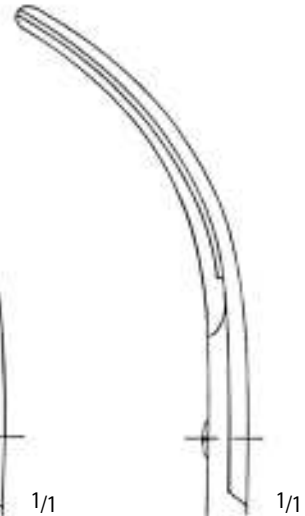

1/1

MA - 858 - 02
23,0 cm / 9"



MAYO - STILLE
MA - 859 - 15
MA - 859 - 17



1/1



1/1

Original 17,0 cm

15,0 cm / 6"
17,0 cm / 6 3/4"



1/1



MAYO - STILLE
MA - 860 - 15
MA - 860 - 17

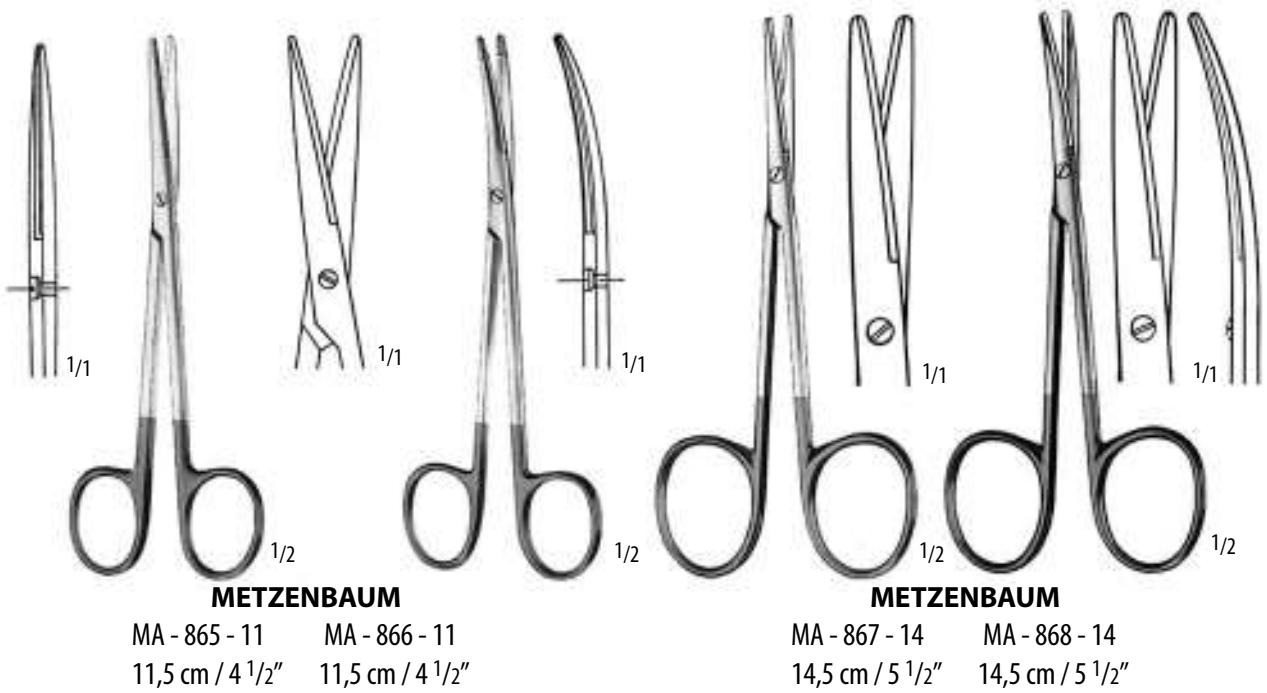
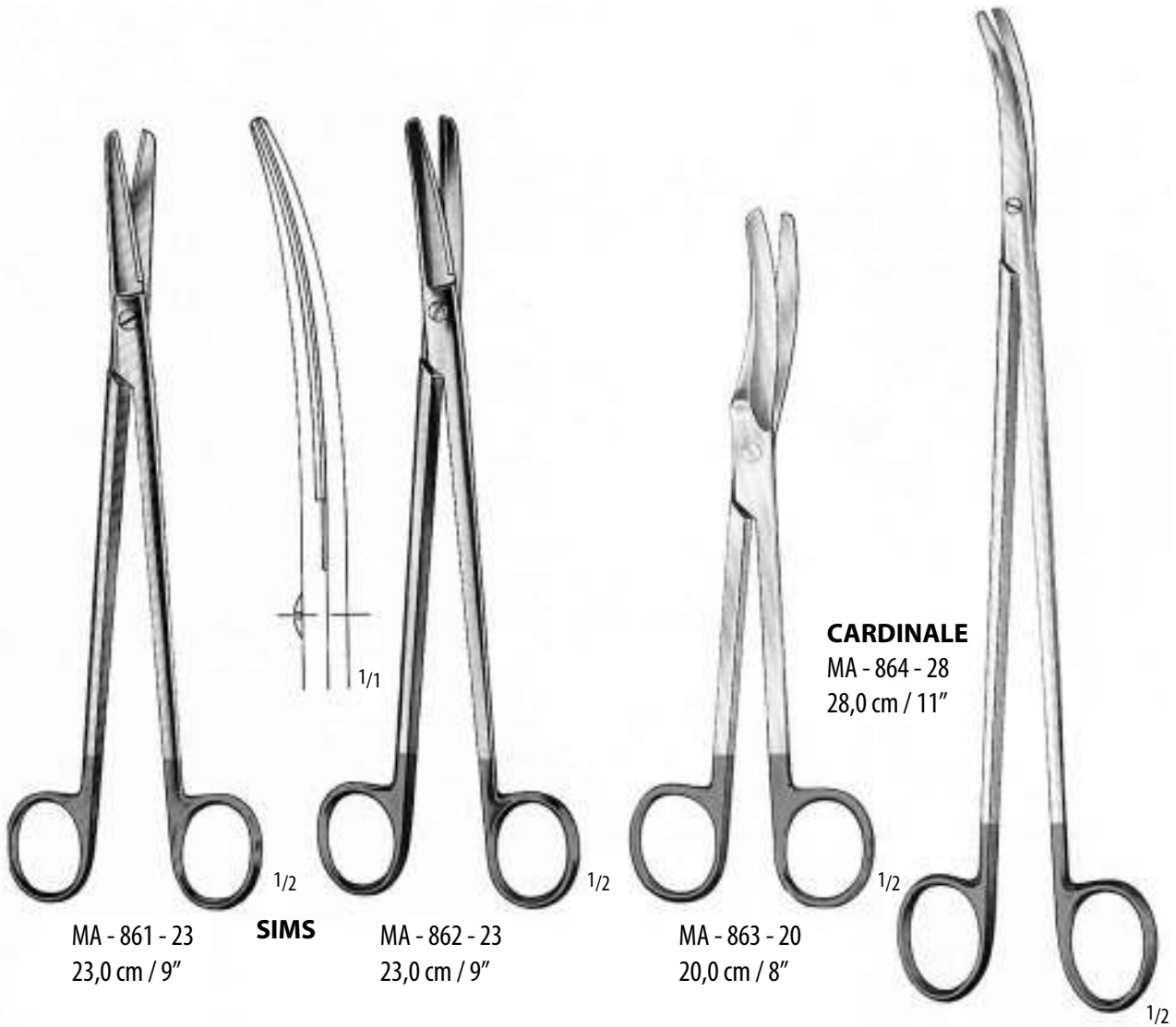

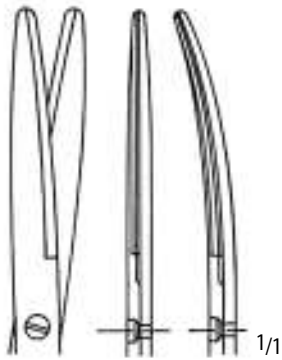

Original 18,0 cm

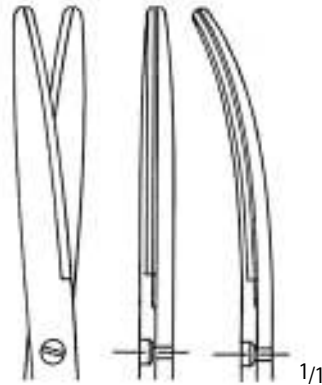

Original 20,0 cm

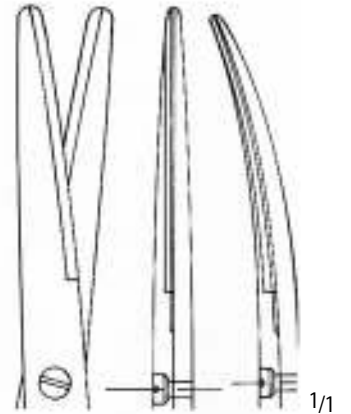

Original 23,0 cm



straight

curved

MA - 869 - 18	18,0 cm / 7"	MA - 870 - 18
MA - 869 - 20	20,0 cm / 8"	MA - 870 - 20
MA - 869 - 23	23,0 cm / 9"	MA - 870 - 23
MA - 869 - 25	25,0 cm / 10"	MA - 870 - 25
MA - 869 - 28	28,0 cm / 11"	MA - 870 - 28
MA - 869 - 30	30,0 cm / 12"	MA - 870 - 30

METZENBAUM

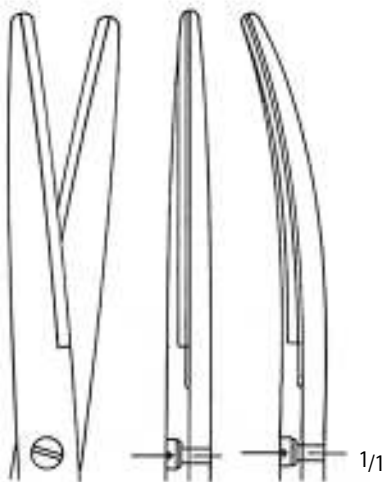

Original 25,0 cm

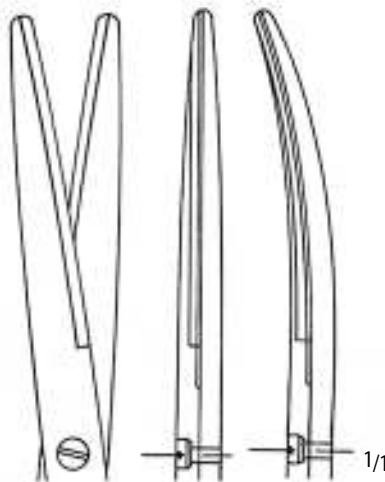

Original 28,0 cm

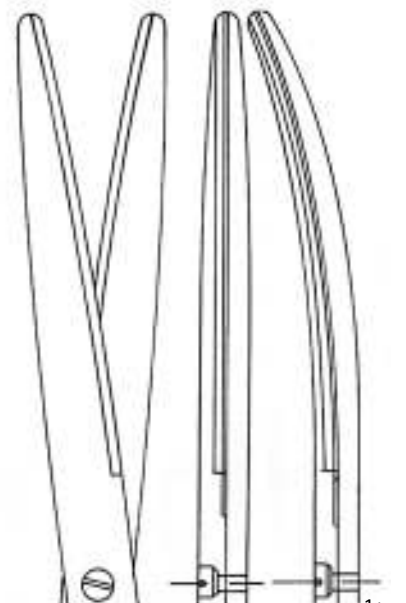

Original 30,0 cm

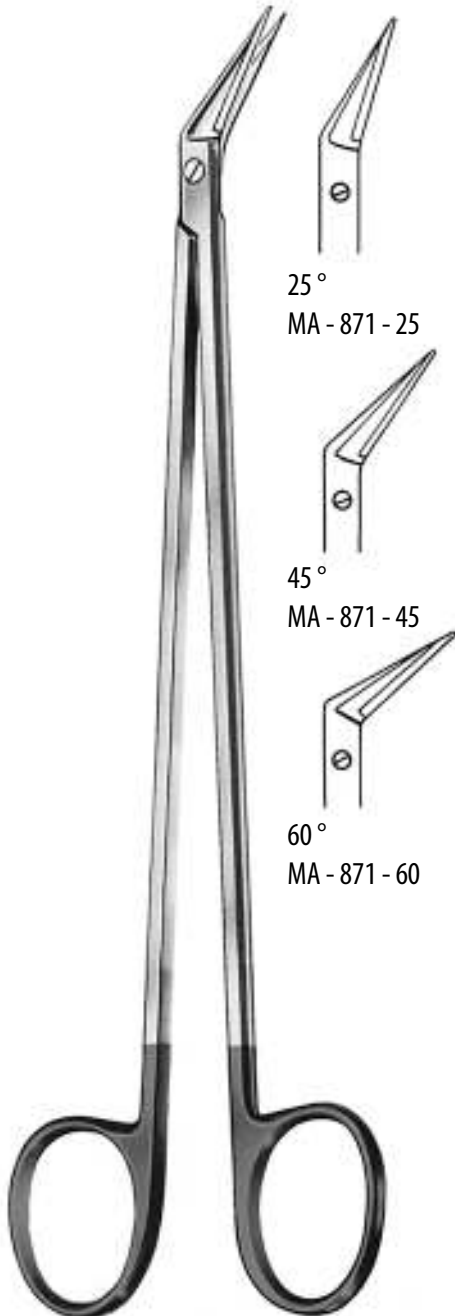

POTTS - SMITH
19,0 cm / 7 1/2"

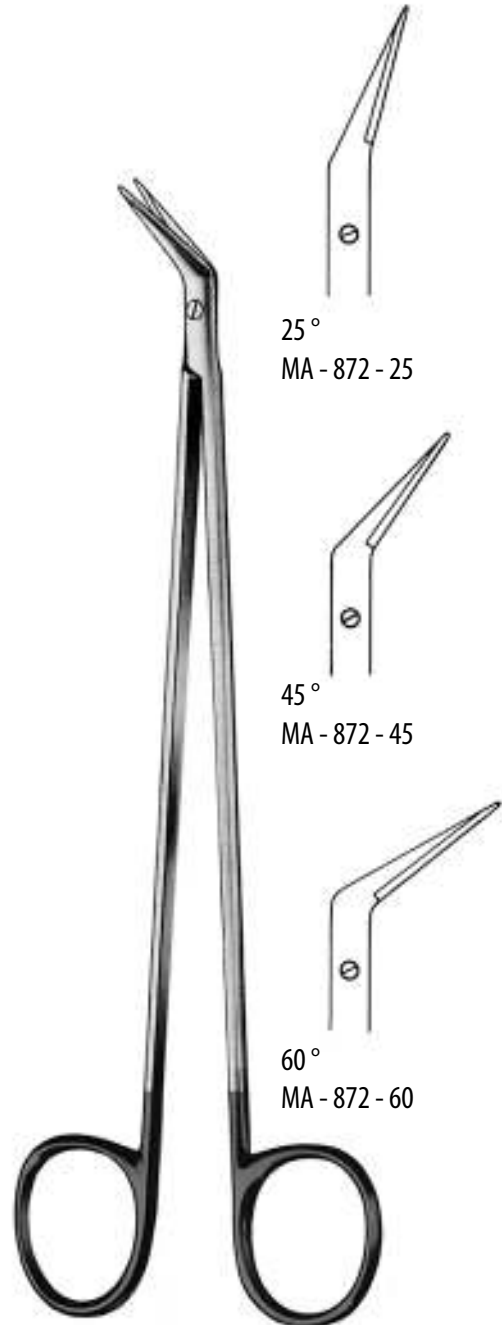

DE BAKEY
18,0 cm / 7"

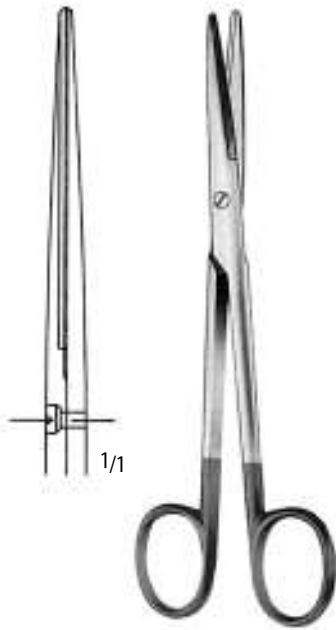

LEXER
MA - 873 - 16
16,0 cm / 6 1/4"



LEXER
MA - 874 - 16
16,0 cm / 6 1/4"

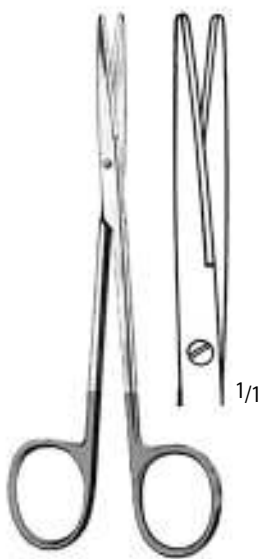

MA - 875 - 14
14,5 cm / 5 1/2"

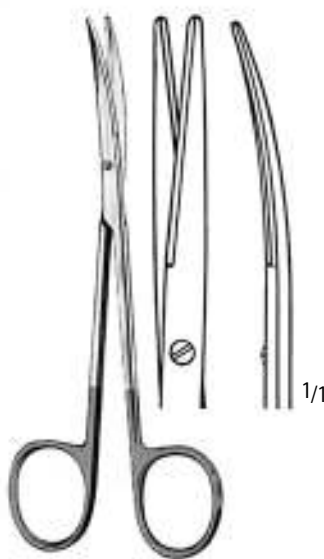

METZENBAUM - DELICATE
MA - 876 - 14 MA - 877 - 14
14,5 cm / 5 1/2" 14,5 cm / 5 1/2"

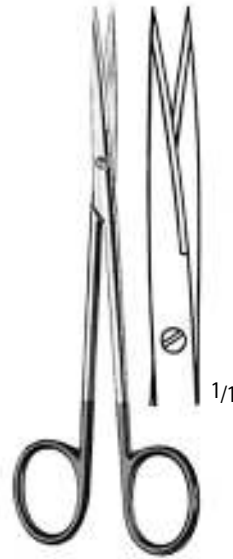

MA - 878 - 14
14,5 cm / 5 1/2"

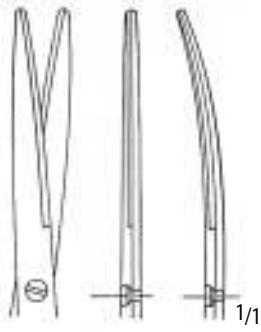

Original 18,0 cm

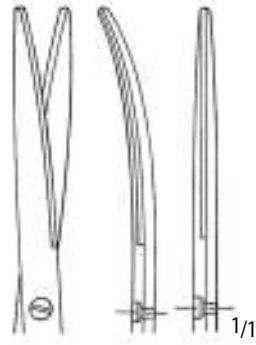

Original 20,0 cm



Original 23,0 cm



straight

curved

MA - 879 - 18	18,0 cm / 7"	MA - 880 - 18
MA - 879 - 20	20,0 cm / 8"	MA - 880 - 20
MA - 879 - 23	23,0 cm / 9"	MA - 880 - 23
MA - 879 - 25	25,0 cm / 10"	MA - 880 - 25
MA - 879 - 28	28,0 cm / 11"	MA - 880 - 28

METZENBAUM - DELICATE



Original 25,0 cm

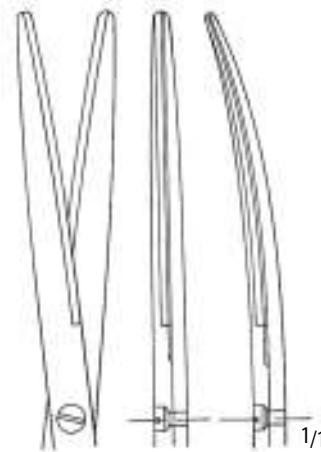

Original 28,0 cm

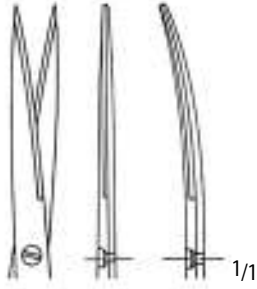

Original 18,0 cm

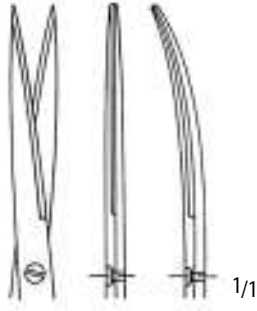

Original 20,0 cm

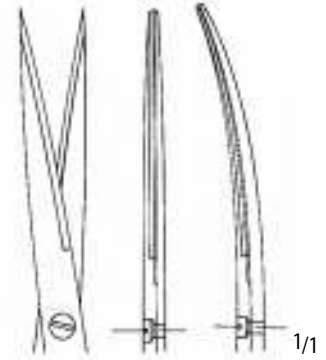

Original 23,0 cm



straight

curved

MA - 881 - 18	18,0 cm / 7"	MA - 882 - 18
MA - 881 - 20	20,0 cm / 8"	MA - 882 - 20
MA - 881 - 23	23,0 cm / 9"	MA - 882 - 23
MA - 881 - 25	25,0 cm / 10"	MA - 882 - 25
MA - 881 - 28	28,0 cm / 11"	MA - 882 - 28

METZENBAUM - DELICATE

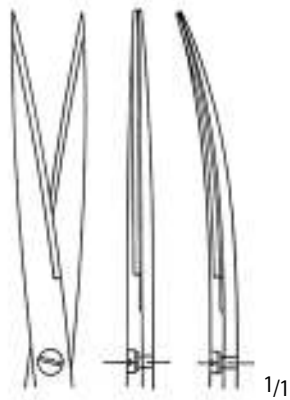

Original 25,0 cm

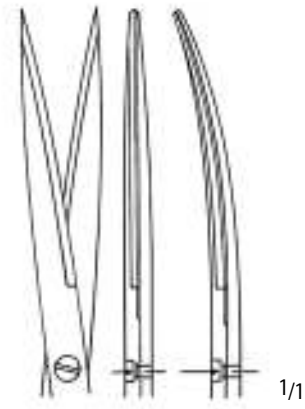

Original 28,0 cm

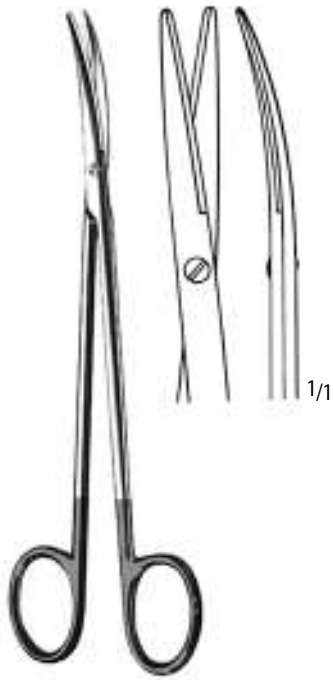

TOENNIS - ADSON - DELICATE
 MA - 883 - 17
 17,5 cm / 7"



GOLDMAN - FOX
 MA - 884 - 13 MA - 885 - 13
 13,0 cm / 5" 13,0 cm / 5"



MA - 886 - 11
 11,5 cm / 4 1/2"



MA - 887 - 11
 11,5 cm / 4 1/2"

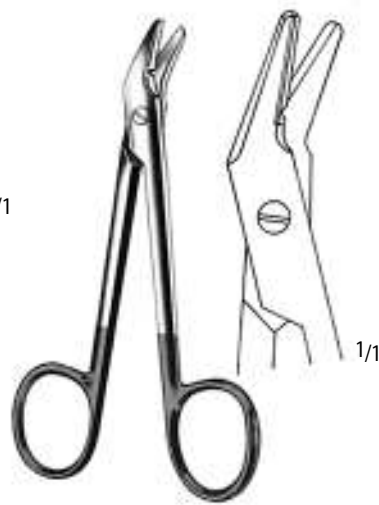

UNIVERSAL
 MA - 889 - 12
 12,0 cm / 4 3/4"



LISTER
 MA - 890 - 18
 18,0 cm / 7"



NOVAK - SCHOECKAERT
OG - 100 - 24
Endometrial biopsy curette
240 mm, 9 1/2"



RANDALL
OG - 101 - 24
Endometrial biopsy curette
240 mm, 9 1/2"

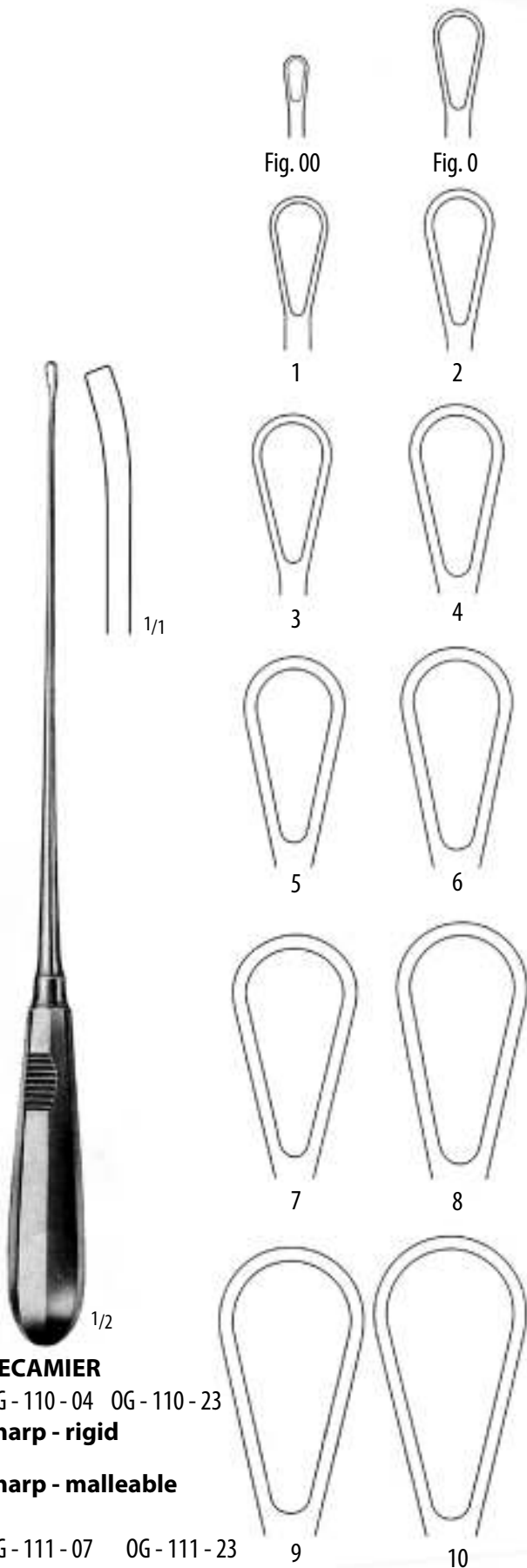

		sharp		blunt
Fig.	Width	rigid	malleable	rigid
00	4,5 mm	OG - 110 - 04		OG - 111 - 07
0	7,5 mm	OG - 110 - 07		
1	8,5 mm	OG - 110 - 08		OG - 111 - 08
2	10,5 mm	OG - 110 - 10		OG - 111 - 10
3	12,0 mm	OG - 110 - 12		OG - 111 - 12
4	14,0 mm	OG - 110 - 14		OG - 111 - 14
5	15,0 mm	OG - 110 - 15		OG - 111 - 15
6	16,5 mm	OG - 110 - 16		OG - 111 - 16
7	18,0 mm	OG - 110 - 18		OG - 111 - 18
8	19,5 mm	OG - 110 - 19		OG - 111 - 19
9	21,5 mm	OG - 110 - 21		OG - 111 - 21
10	23,5 mm	OG - 110 - 23		OG - 111 - 23

RECAMIER
OG - 110 - 04 OG - 110 - 23
sharp - rigid

sharp - malleable

OG - 111 - 07 OG - 111 - 23
blunt - rigid
max. 300 mm, 12"



1/2

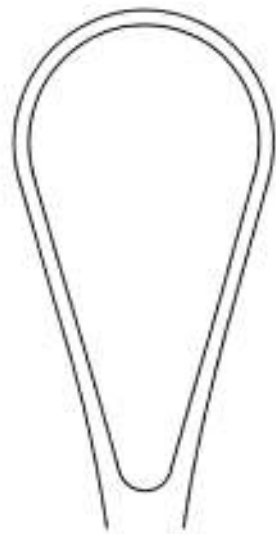
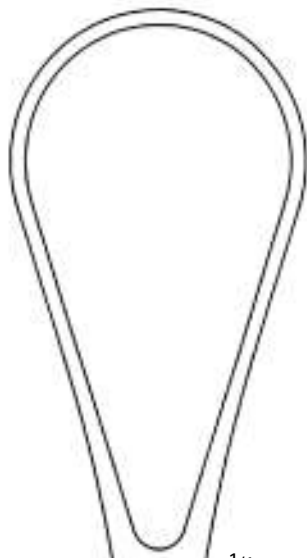

Fig. 1



1/1

Fig. 2

RECAMIER
OG - 200 - 34 OG - 200 - 29
blunt - rigid
max. 360 mm, 14 3/8"

Fig.	Width	blunt rigid
1	34,5 mm	OG - 200 - 34
2	39,5 mm	OG - 200 - 39



1/2



Fig. 1



Fig. 2











1/1

Fig. 3

BUMM
OG - 201 - 23 OG - 201 - 28 sharp - malleable
OG - 202 - 23 OG - 202 - 28 blunt - malleable
max. 310 mm, 12 3/8"







Fig.	Width	sharp malleable	blunt malleable
1	23,5 mm	OG - 201 - 23	OG - 202 - 23
2	26,0 mm		OG - 202 - 26
3	28,5 mm	OG - 201 - 28	OG - 202 - 28



3 mm	4 mm	5 mm	
			
Fig. 000	00	0	
OG-250-01	OG-250-02	OG-250-03	
6 mm	8 mm	10 mm	12 mm
			
Fig. 1	2	3	4
OG-251-01	OG-251-02	OG-251-03	OG-251-04











BRUNS
OG - 250 - 01 OG - 251 - 04
1/2 165 mm, 6 1/2"



2,5 mm	3,4 mm	4,2 mm	
			
Fig. 000	00	0	
OG-252-01	OG-252-02	OG-252-03	
5,2 mm	6,3 mm	7,4 mm	8 mm
			
Fig. 1	2	3	4
OG-253-01	OG-253-02	OG-253-03	OG-253-04



SCHEDE
OG - 252 - 01 OG - 253 - 04
1/2 170 mm, 6 3/4"



2,8 mm	3,6 mm	4,4 mm	5,2 mm	6,8 mm
				
Fig. 0000	000	00	0	1
OG-254-01	OG-254-02	OG-254-03	OG-254-04	OG-254-05
8,5 mm	10 mm	11,5 mm	13 mm	14,5 mm
				
Fig. 2	3	4	5	6
OG-255-01	OG-255-02	OG-255-03	OG-255-04	OG-255-05

VOLKMANN
OG - 254 - 01 OG - 255 - 05
1/2 170 mm, 6 3/4"



3,4 mm	5,2 mm
	
Fig. 00	1
OG-256-01	OG-256-02

WILLIGER
OG - 256 - 01 OG - 256 - 02
1/2 170 mm, 6 3/4"

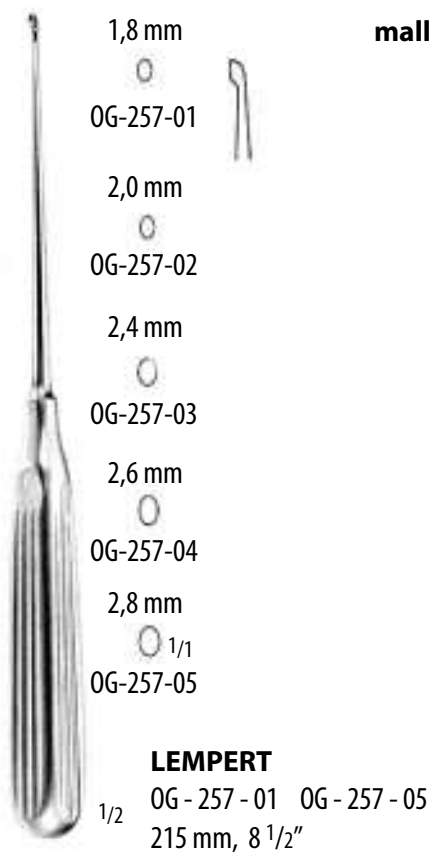

malleable

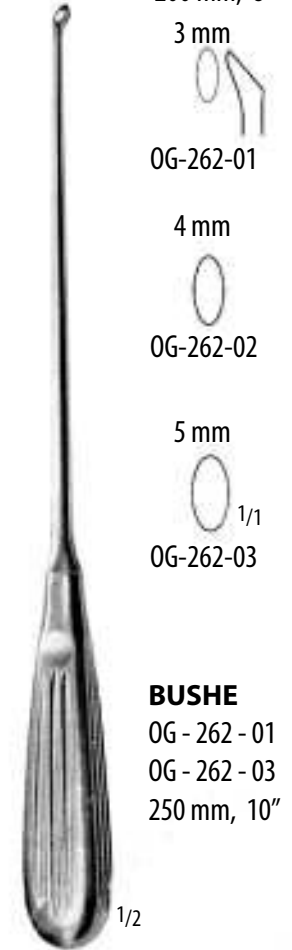
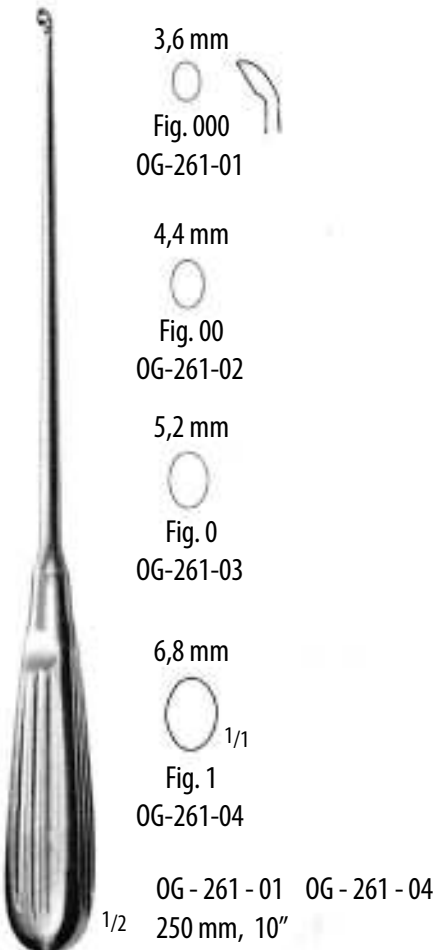
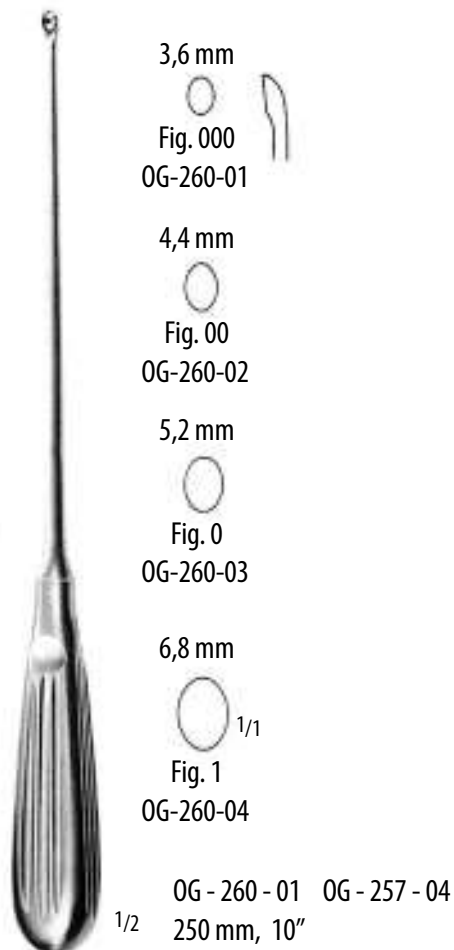
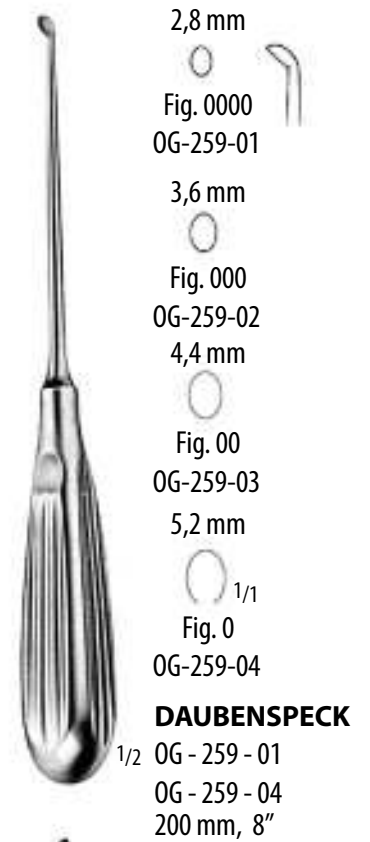
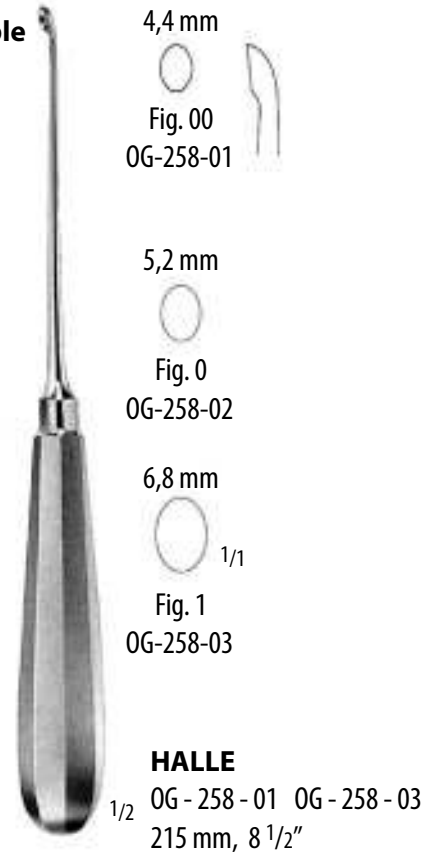

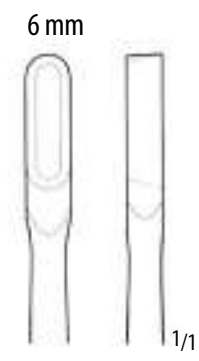

TESSIER
OG - 265 - 22
1/2 220 mm, 8 3/4"



SIMON
OG - 266 - 01 OG - 266 - 03
1/2 235 mm, 9 1/4"

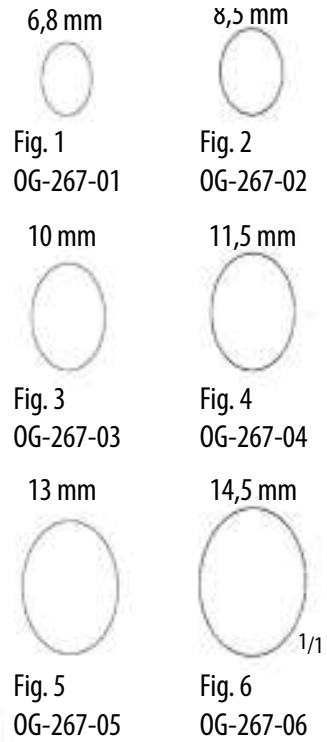
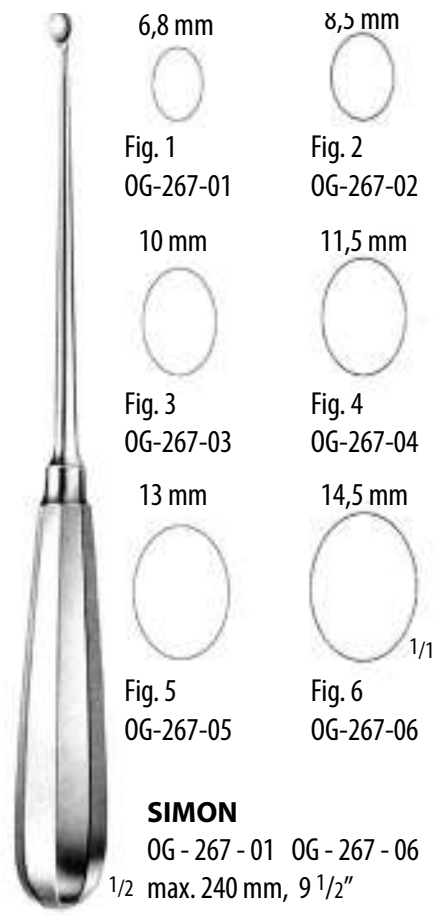

SIMON
OG - 267 - 01 OG - 267 - 06
1/2 max. 240 mm, 9 1/2"

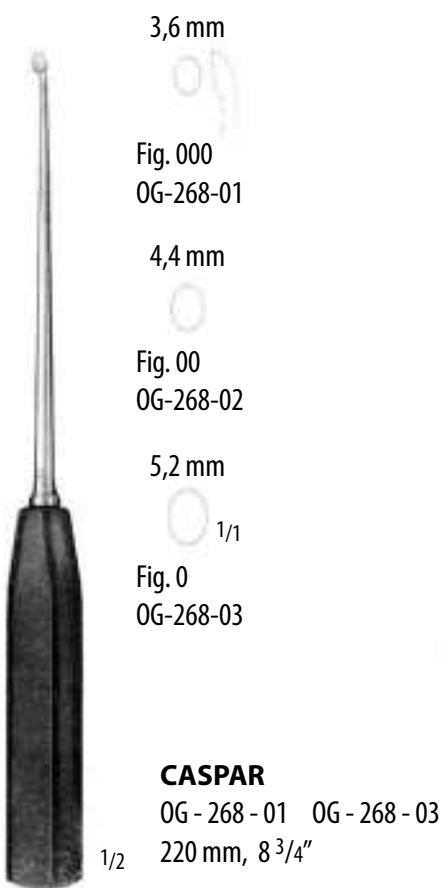

CASPAR
OG - 268 - 01 OG - 268 - 03
1/2 220 mm, 8 3/4"

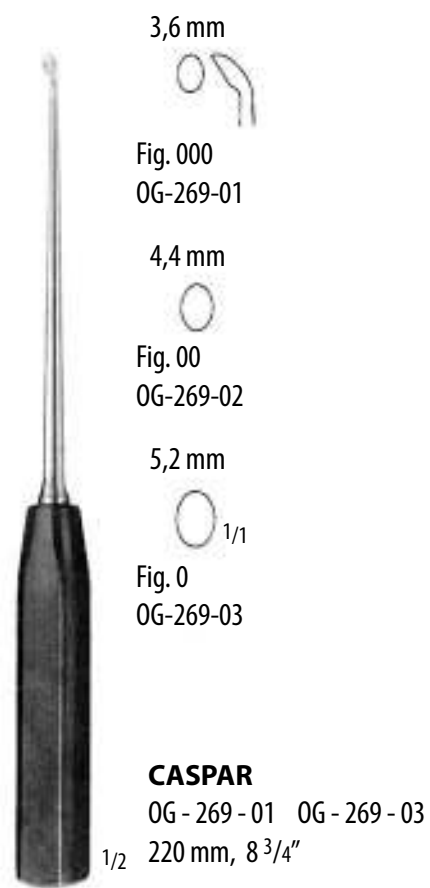

CASPAR
OG - 269 - 01 OG - 269 - 03
1/2 220 mm, 8 3/4"

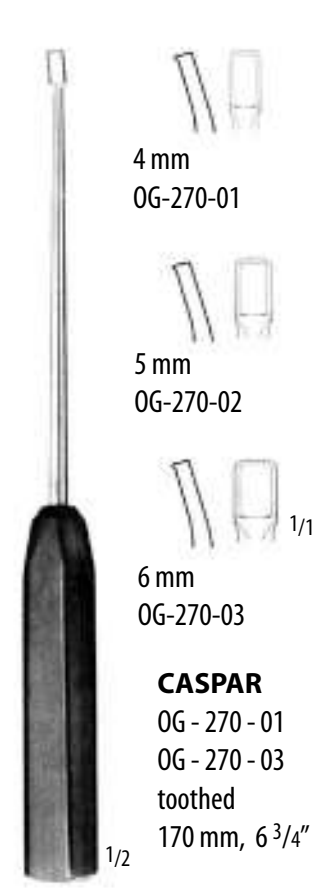

CASPAR
OG - 270 - 01
OG - 270 - 03
toothed
170 mm, 6 3/4"



OG - 275 - 01
270 mm, 10^{3/4}"

4,4 mm



Fig. 00
OG-275-01

6,8 mm



Fig. 1
OG-275-02

8,5 mm



Fig. 2
OG-275-03

10 mm



Fig. 3
OG-275-04

1/1

1/2



SAUERBRUCH-FREY

OM - 200 - 37
for the first rib
370 mm, 14³/₄"



BRUNNER

OM - 201 - 34
Universal pattern
340 mm, 13¹/₂"



GIERTZ-STILLE

OM - 202 - 25
250 mm, 10"



SEMBO
OM - 210- 19
Rib- and bone holding forceps
190 mm, 7¹/₂"



SEMBO
OM - 211- 19
Rib- and bone holding forceps
190 mm, 7¹/₂"

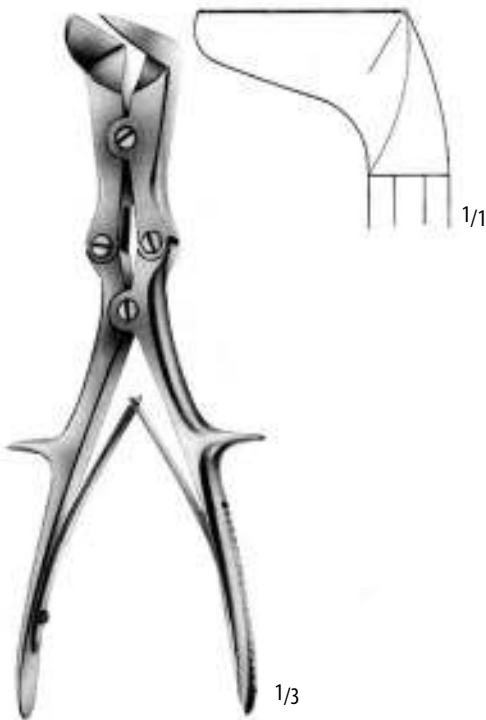

LISTON-STILLE
OM - 212- 26
265 mm, 10¹/₂"



**LISTON-KEY-HORSLEY
(TUDOR EDWARDS)**
OM - 213- 25
255 mm, 10"

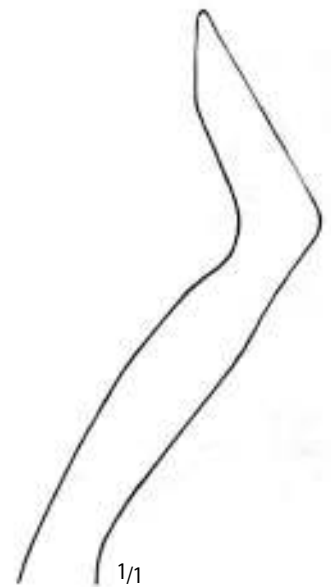

S-shaped for posterior rib ends

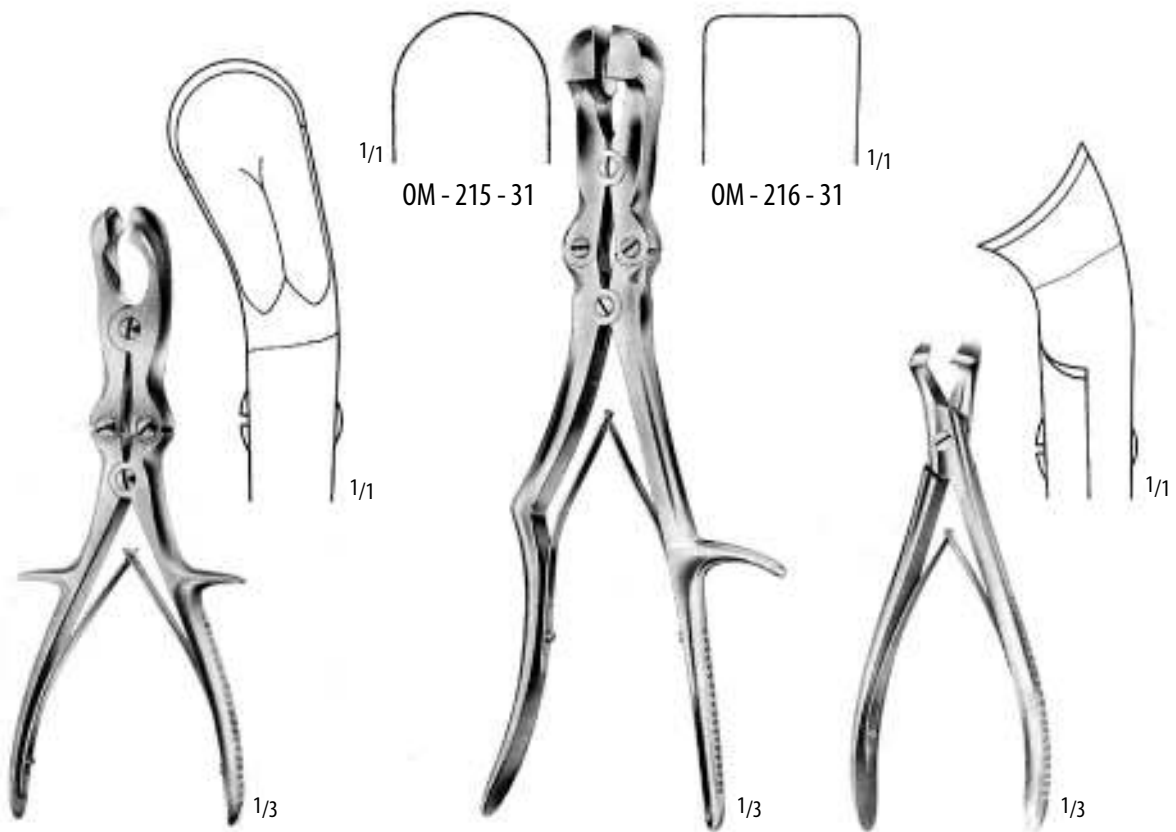

SEM

OM - 214 - 24

Rib rongeur to shorten the rib stumps
240 mm, 9 1/2"

SAUERBRUCH-CORYLLOS

OM - 215 - 31 - OM - 216 - 31

Rib rongeurs to shorten the rib stumps
310 mm, 12 3/8"

MARKWALDER

OM - 217 - 19

Rib rongeur to round the rib stumps
190 mm, 7 1/2"

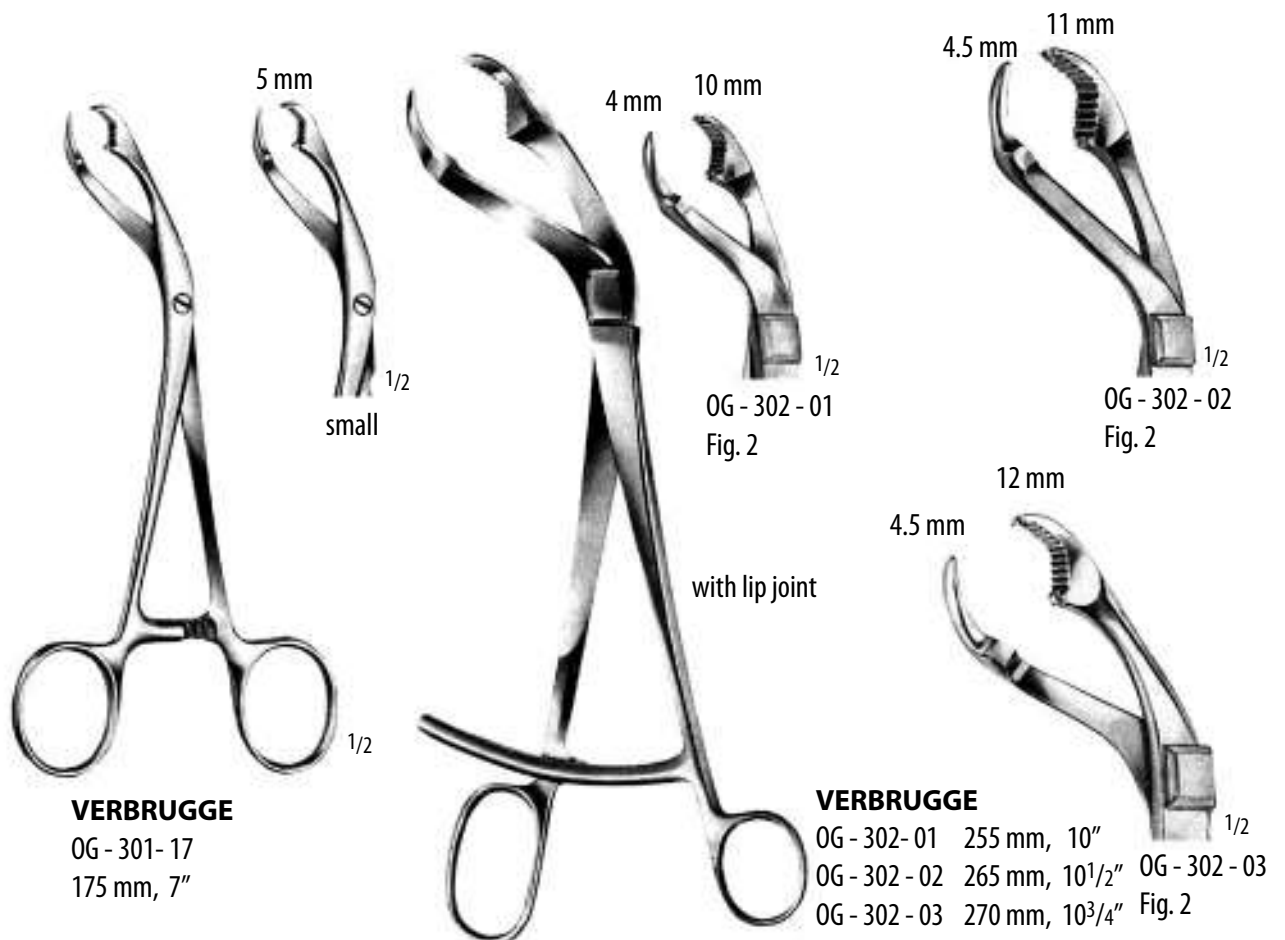
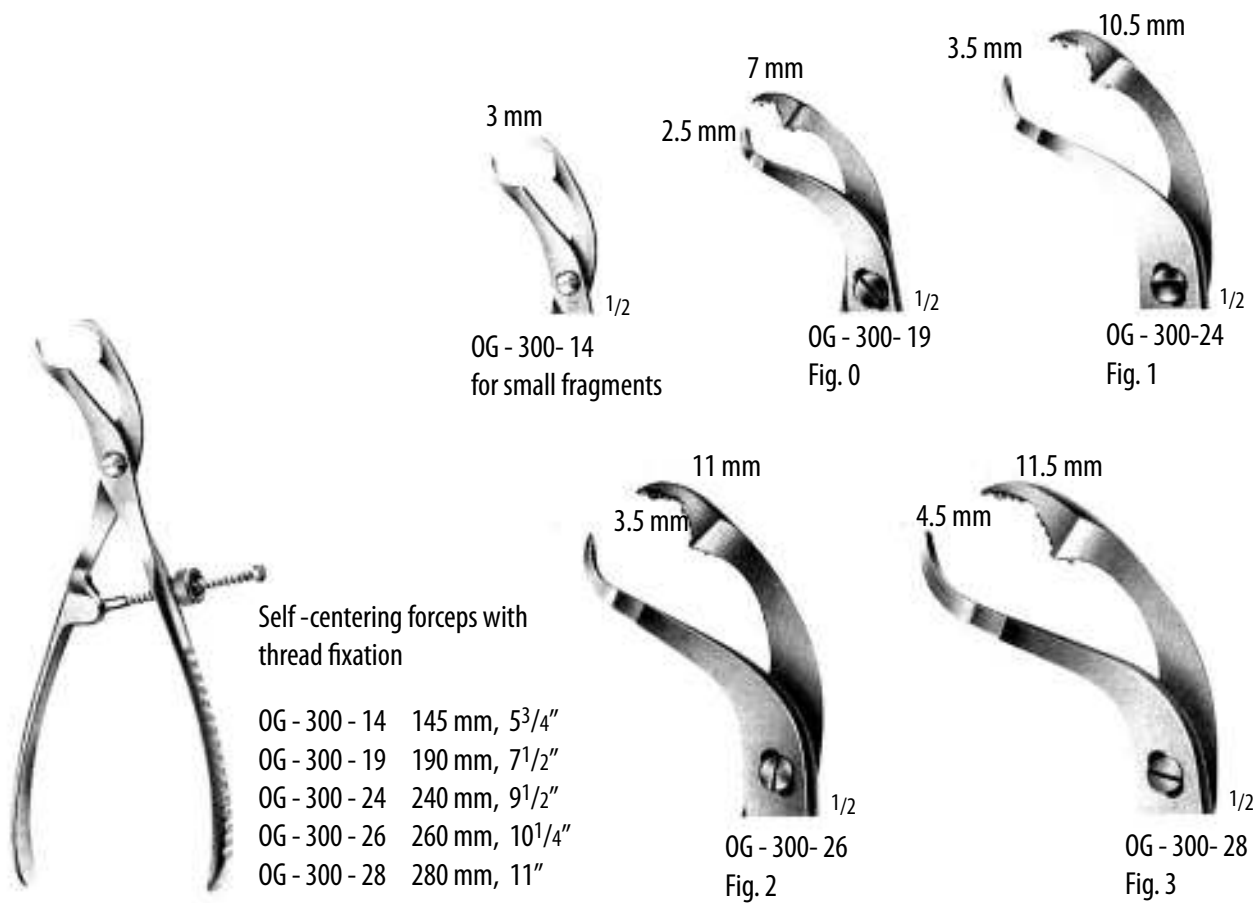

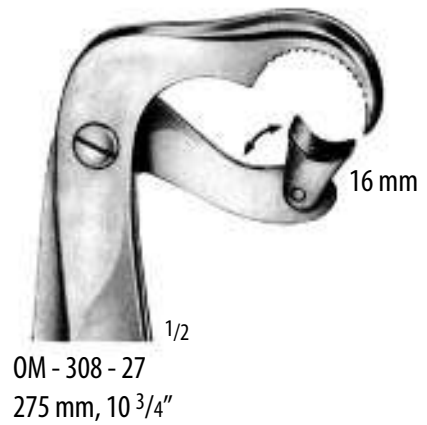
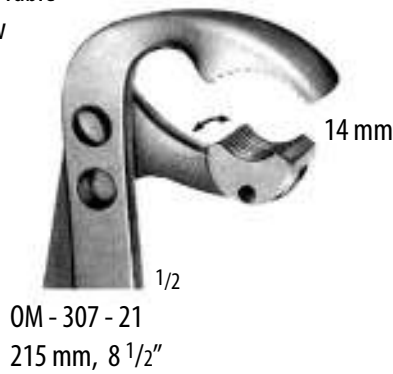



LOWMAN
OM - 310 - 17 170 mm, 6³/₄"
OG - 310 - 20 205 mm, 8"



LOWMAN - GERSTER
OM - 311 - 21
210 mm, 8¹/₄"



LOWMAN - HOGLUND
OM - 312 - 17
175 mm, 7"

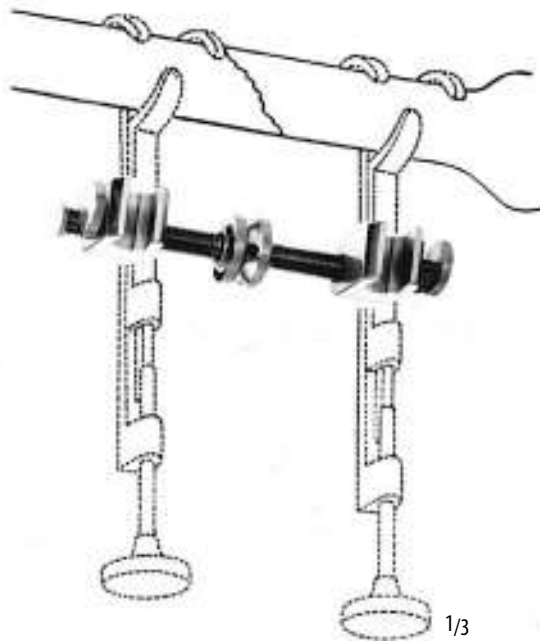

GERSTER
OM - 313 - 00
Traction bar for OM - 310 - 17 - OM - 312 - 17



ECHLIN
OM - 350 - 23 - OM - 351 - 23
230 mm, 9"



FRYKHOLM
OM - 352 - 24
240 mm, 9 1/2"

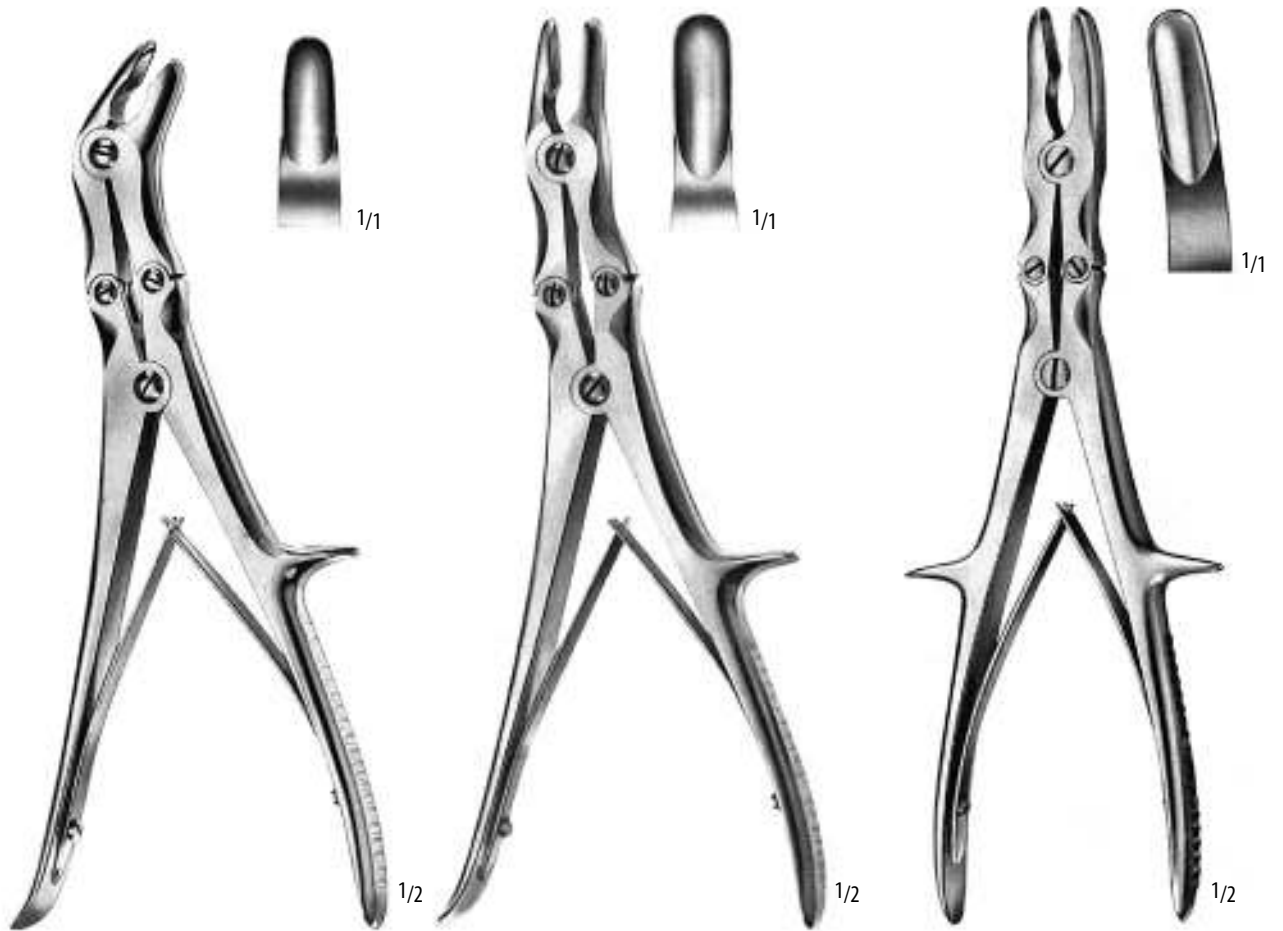

STILLE
OM - 353- 23
235 mm, 9¹/₄"

LEKSELL - STILLE
OM - 354- 24
240 mm, 9¹/₂"

STILLE-RUSKIN
OM - 355- 24
240 mm, 9¹/₂"



OM - 360 - 14
140 mm, 5 1/2"



OM - 360 - 17
170 mm, 6 3/4"



OM - 360 - 20
200 mm, 8"



OM - 360 - 22
220 mm, 8 3/4"



LISTON
OM - 360 - 14 - OM - 360 - 22



OM - 361 - 17
170 mm, 6 3/4"



OM - 361 - 20
200 mm, 8"



OM - 361 - 22
220 mm, 8 3/4"



LISTON
OM - 361 - 17 - OM - 361 - 22

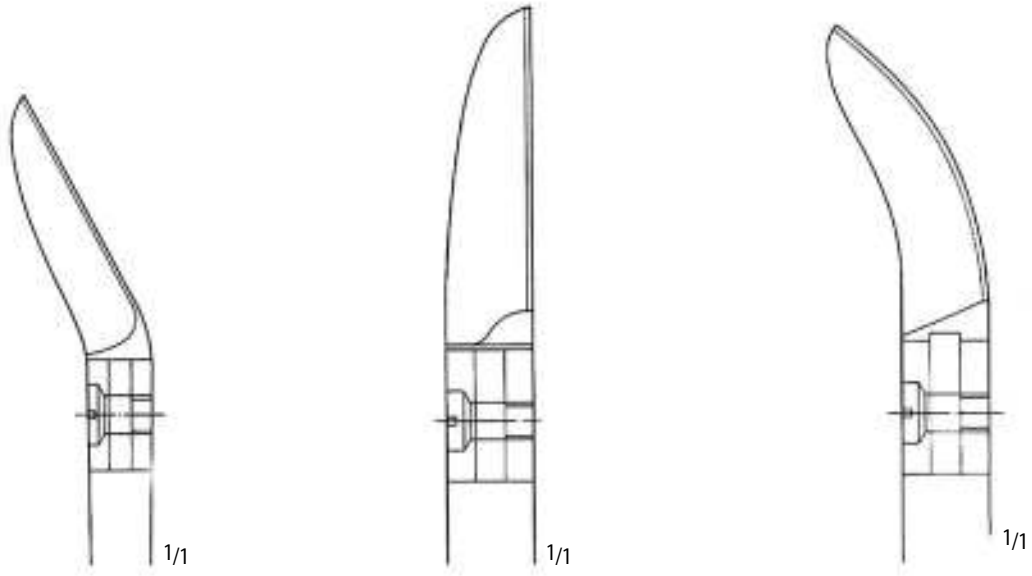

LISTON
OM - 365 - 24
curved on flat
240 mm, 9 1/2"



LISTON
OM - 366 - 28
straight
280 mm, 11"



LISTON
OM - 367 - 28
curved on flat
280 mm, 11"

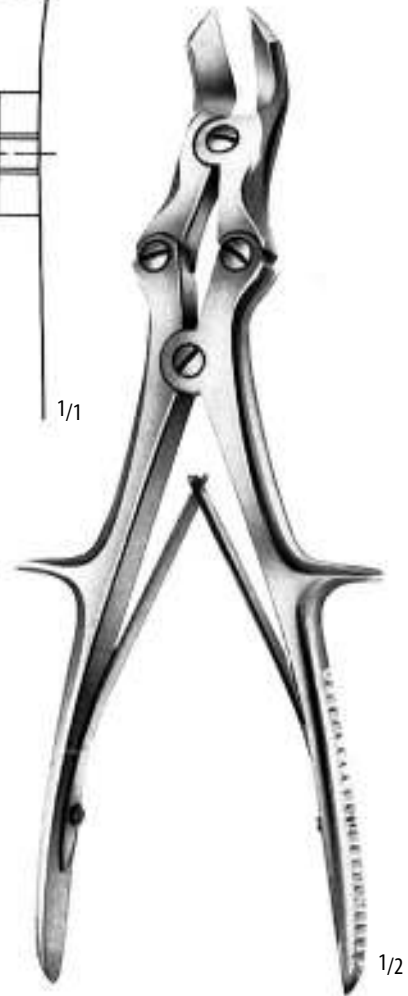
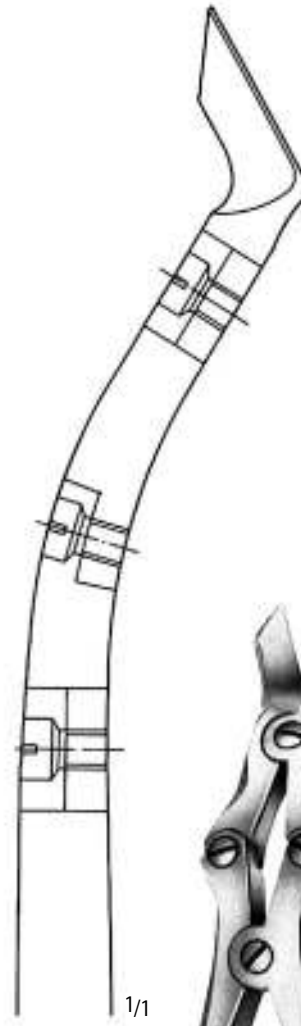
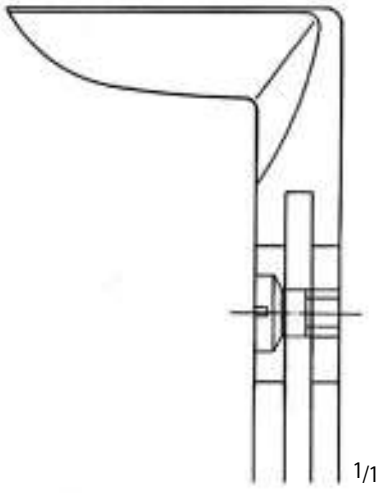

LISTON - STILLE
OM - 368 - 26
265 mm, 10¹/₂"

**LISTON - KEY - HORSLEY
(TUDOR EDWARDS)**
OM - 369 - 25
255 mm, 10"



HENNIG
OF - 200 - 27
270 mm, 10³/₄"



MOD. USA
OF - 201 - 23
230 mm, 9"



OF - 202 - 29
290 mm, 11¹/₂"



WOLF
OF - 203 - 18 180 mm, 7"
OF - 203 - 24 240 mm, 9¹/₂"
Plaster breakers



**Cutter for cutting off KIRSCHNER wires, Tibia head screws,
bolts, pins, up to 6 mm diam.**

OF-205 - 47

470 mm, 18¹/₂"

for soft wire
up to diam



OF - 206 - 14
145 mm, 5³/₄"

1/2

for hard wire
up to diam

1.5 mm
1.0 mm



OF - 207 - 14
145 mm, 5³/₄"

1/2

2.0 mm
1.5 mm



OF - 208 - 22
220 mm, 8³/₄"

1/2

for soft wire
up to diam

3.5 mm
2.5 mm

for hard wire
up to diam



OF - 210 - 32
320 mm, 12³/₄"

1/2

3.0 mm
3.0 mm

OF - 211 - 17
Angled slender pattern
for wire removal after
sternum suture.

170 mm, 6³/₄"

for soft wire
up to diam

for hard wire
up to diam

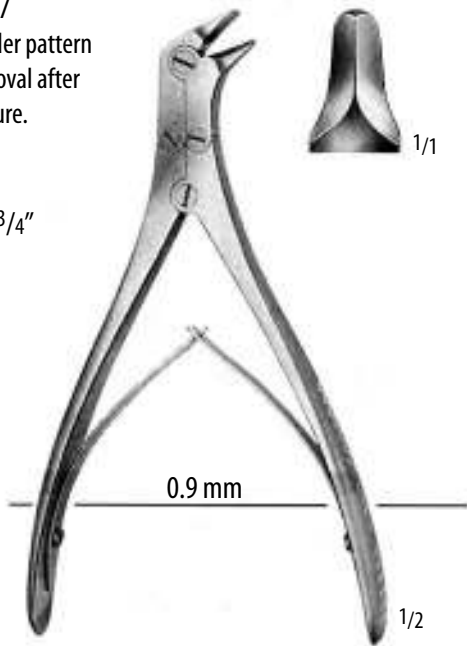

OF - 212 - 24
240 mm, 9¹/₂"

with carbide cutting
edges

2.0 mm

1.6 mm

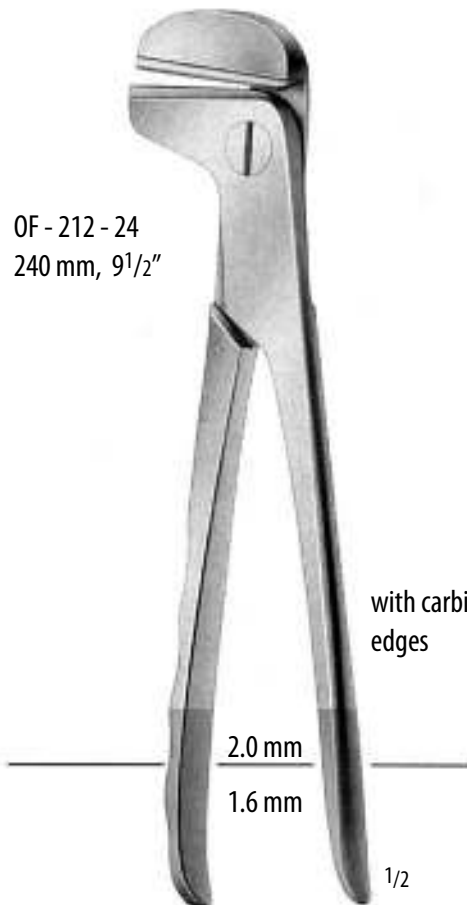

OF - 213 - 18
Front and lateral
cutting action

180 mm, 7"

for soft wire
up to diam

for hard wire
up to diam

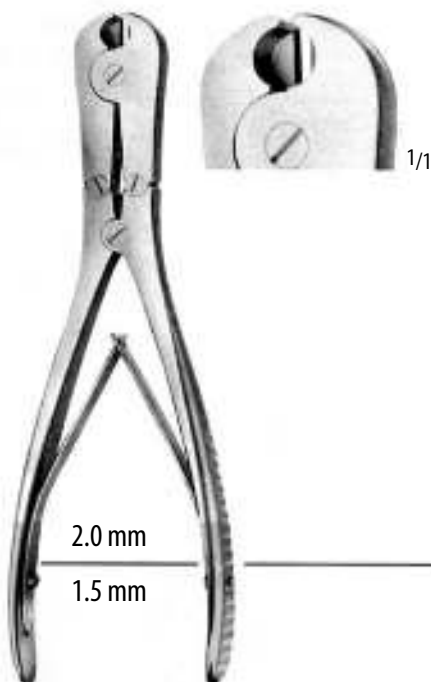

REILL
OF - 214 - 17
175 mm, 7"

for cutting off wires
close to the bone

2.0 mm

1.6 mm

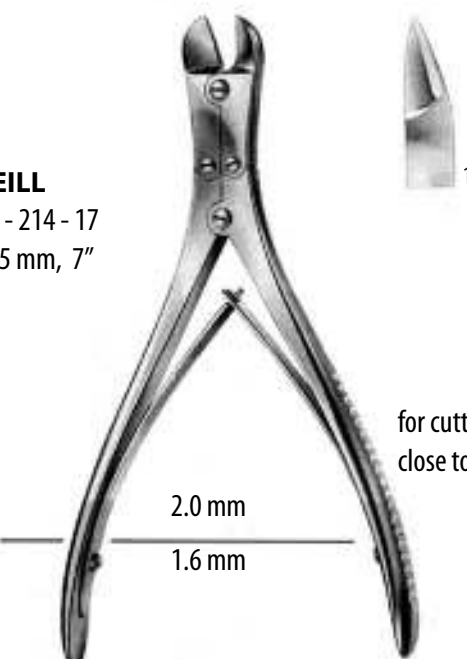

OF - 215 - 23
235 mm, 9¹/₄"

for soft wire
up to diam

for hard wire
up to diam

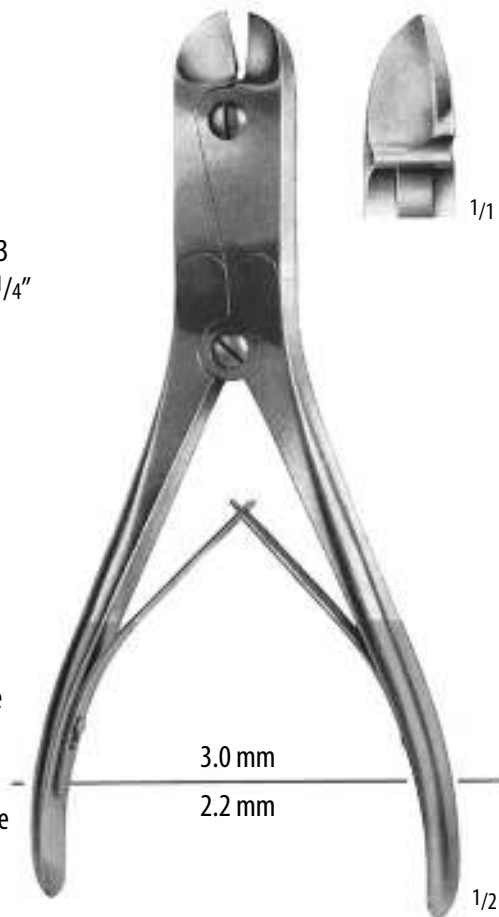

HARVEY
OF - 216 - 23
235 mm, 9¹/₄"

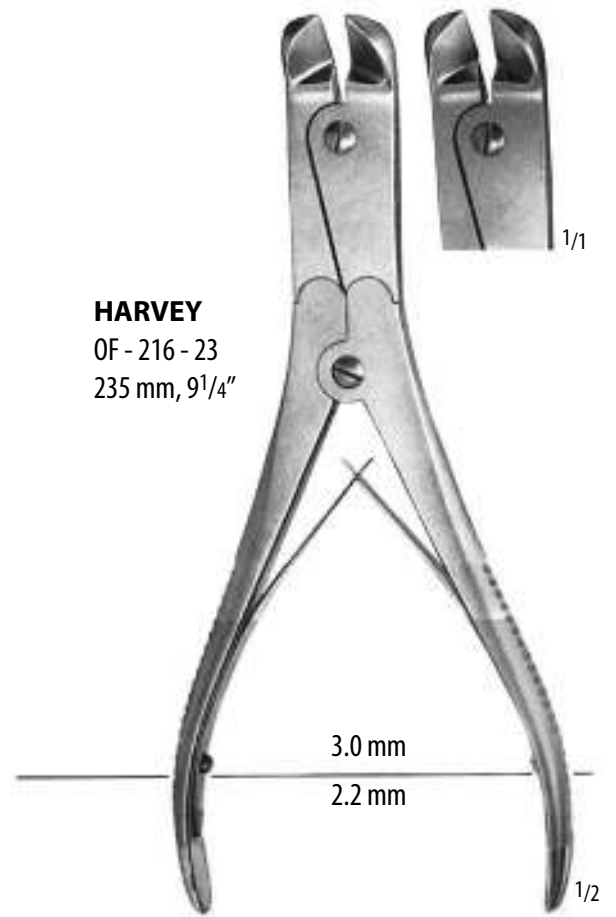



with serrated jaws
OF - 400 - 14
140 mm, 5¹/₂"

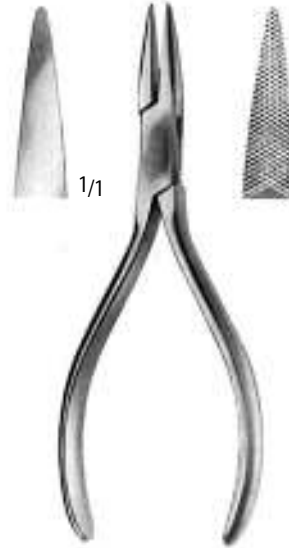

OF - 401 - 14
one jaw smooth
one jaw serrated
140 mm, 5¹/₂"

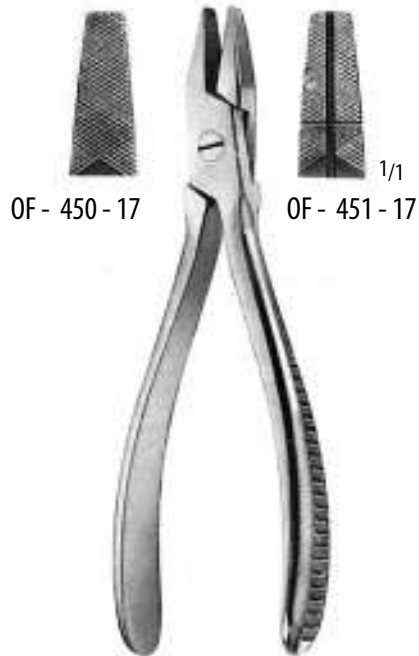

OF - 450 - 17

OF - 451 - 17

OF - 450 - 17
with serrated jaws
OF - 451 - 17
with longitudinal and
transversal grooves
170 mm, 6³/₄"



OF - 452 - 19
190 mm, 7¹/₂"



BUNNEL
OF - 900 - 16
160 mm, 6¹/₄"

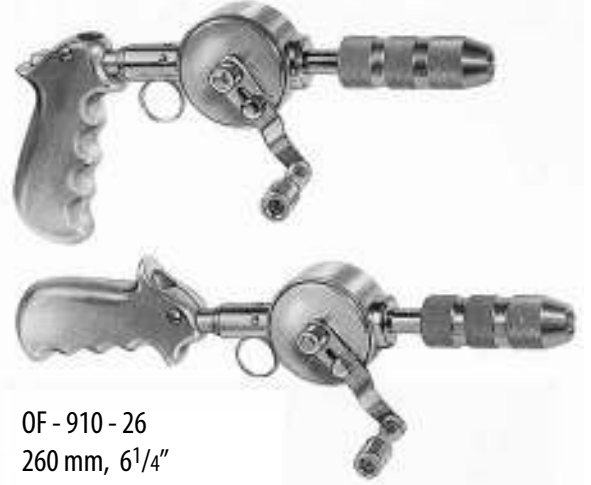

OF - 910 - 26
260 mm, 6¹/₄"

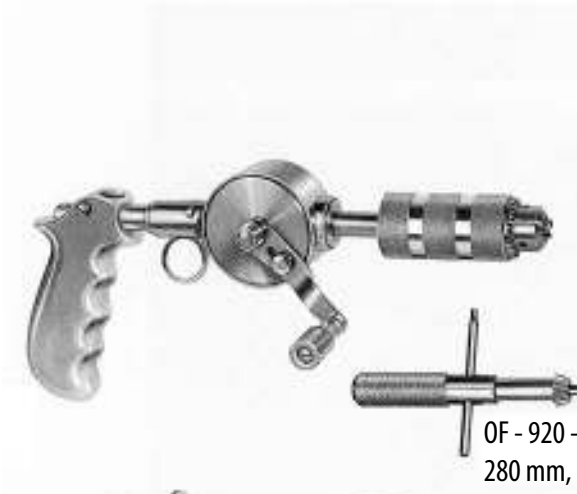

OF - 920 - 00
280 mm, 11"





Ø				
1.0 mm				
1.5 mm			OF - 931 - 02	70/40
2.0 mm			OF - 931 - 03	100/50
2.5 mm	OF - 930 - 04	175/135	OF - 931 - 04	100/50
2.8 mm			OF - 931 - 05	100/50
3.0 mm			OF - 931 - 06	100/60
3.2 mm			OF - 931 - 07	100/60
3.5 mm	OF - 930 - 08	210/170	OF - 931 - 08	100/60
4.0 mm			OF - 931 - 09	110/70
4.5 mm	OF - 930 - 10	210/170	OF - 931 - 10	150/80
5.0 mm			OF - 931 - 11	160/90
6.0 mm			OF - 931 - 12	160/90



Ferris-Smith-Kerrison





Width of bite

Length of shaft

			15 cm, 6"	20 cm, 8"	18 cm, 7"
cutting upward		1 mm			OF - 502 -01
		2 mm			OF - 502 -02
		3 mm	OF - 500 -03	OF - 501 -03	OF - 502 -03
		4 mm			OF - 502 -04
		5 mm	OF - 500 -05	OF - 501 -05	OF - 502 -05
cutting upward 40°		1 mm			OF - 507 -01
		2 mm			OF - 507 -02
		3 mm	OF - 505 -03	OF - 506 -03	OF - 507 -03
		4 mm			OF - 507 -04
		5 mm	OF - 505 -05	OF - 506 -05	OF - 507 -05
cutting downward		1 mm			OF - 512 -01
		2 mm			OF - 512 -02
		3 mm	OF - 510 -03	OF - 511 -03	OF - 512 -03
		4 mm			OF - 512 -04
		5 mm	OF - 510 -05	OF - 511 -05	OF - 512 -05



Love-Kerrison

		Width of bite	Length of shaft		
			15 cm, 6"	20 cm, 8"	18 cm, 7"
cutting upward		2 mm			OF - 522 - 02
		3 mm	OF - 520 - 03	OF - 521 - 03	OF - 522 - 03
		4 mm	OF - 520 - 04	OF - 521 - 04	OF - 522 - 04
		5 mm	OF - 520 - 05	OF - 521 - 05	OF - 522 - 05
		6 mm			OF - 522 - 06
cutting upward 40°		2 mm			OF - 527 - 02
		3 mm			OF - 527 - 03
		4 mm			OF - 527 - 04
		5 mm			OF - 527 - 05
		6 mm			OF - 527 - 06
cutting downward		2 mm			OF - 532 - 02
		3 mm	OF - 530 - 03	OF - 531 - 03	OF - 532 - 03
		4 mm	OF - 530 - 04	OF - 531 - 04	OF - 532 - 04
		5 mm	OF - 530 - 05	OF - 531 - 05	OF - 532 - 05
		6 mm			OF - 532 - 06
cutting downward 40°		2 mm			OF - 537 - 02
		3 mm			OF - 537 - 03
		4 mm			OF - 537 - 04
		5 mm			OF - 537 - 05
		6 mm			OF - 537 - 06



BOYNTON
OP - 200 - 12
12,0 cm/4"



ARRUGA
16,0 cm/6¹/₄"

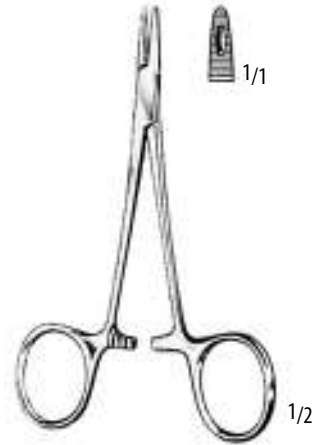

DERF
PO - 210 - 12
12,0 cm/4³/₄"

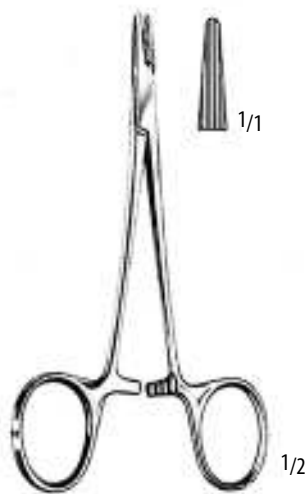

DERF- CONVERSE
PO - 211 - 12
12,5 cm/5"



COLLIER
PO - 212 - 12
12,5 cm/5"



DOYEN
PO - 213 - 12
12,5 cm/5"

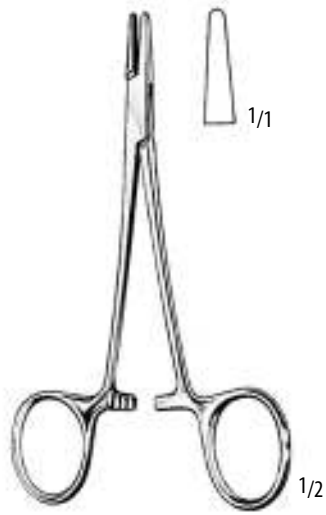

WEBSTER
PO - 214 - 13
13,0 cm / 5"

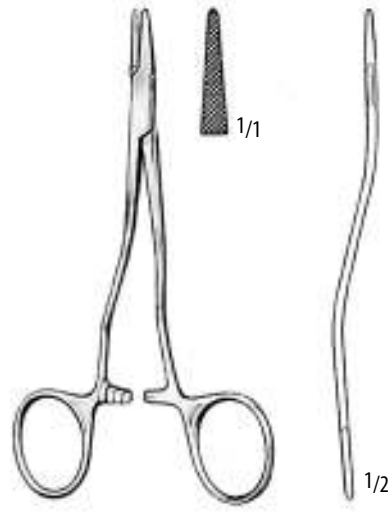

KILNER
PO - 215 - 13
13,0 cm / 5"

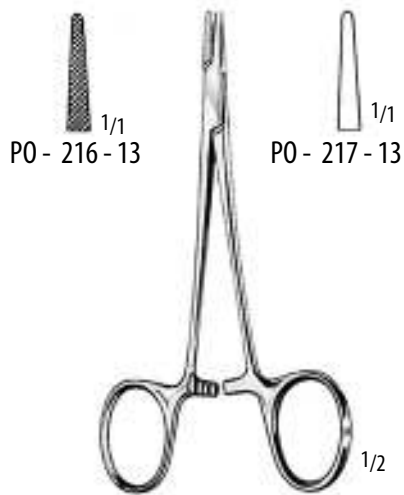

HALSEY
13,0 cm / 5"

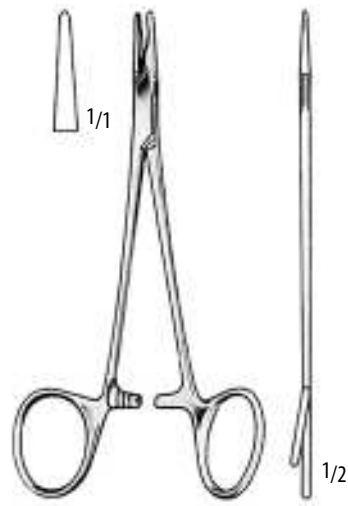

NEIVERT
PO - 218 - 13
13,0 cm / 5"



CRILE-WOOD
15,0 cm/6" PO - 219 - 15
18,0 cm/7" PO - 219 - 18



BABY- CRILE- WOOD
PO - 220 - 15
15,0 cm/6"



CARROLL
PO - 221 - 15
15,0 cm/6"

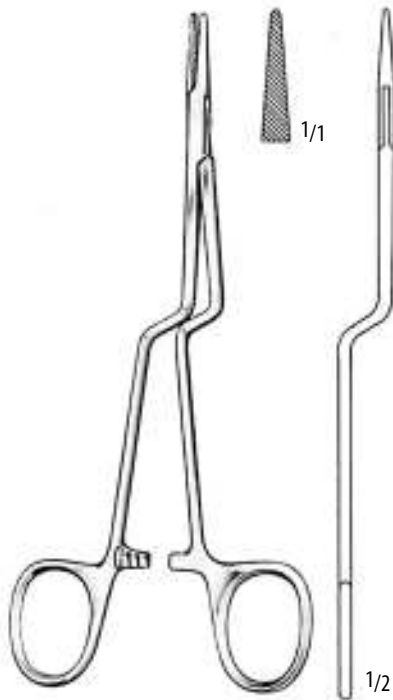

JACOBSON
PO - 222 - 18
18,0 cm/7"



BOZEMANN

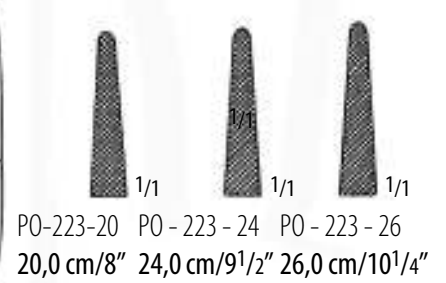

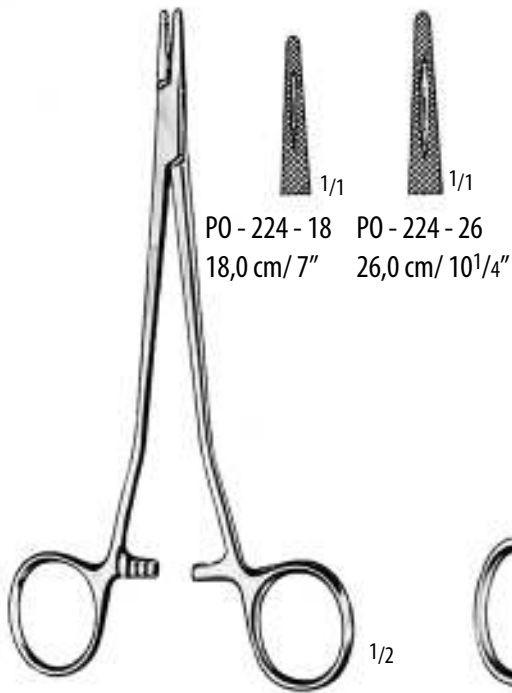

SAROT

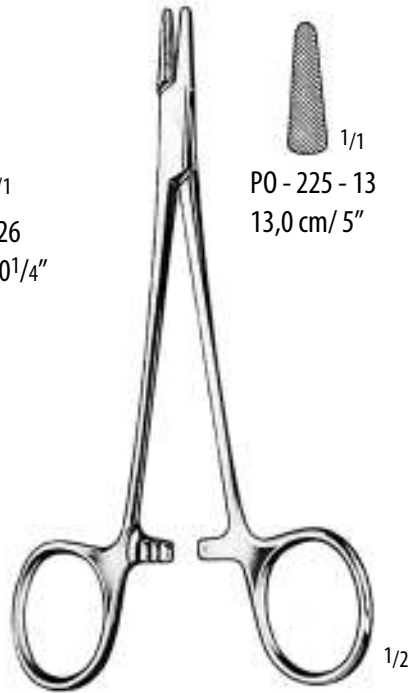

BROWN

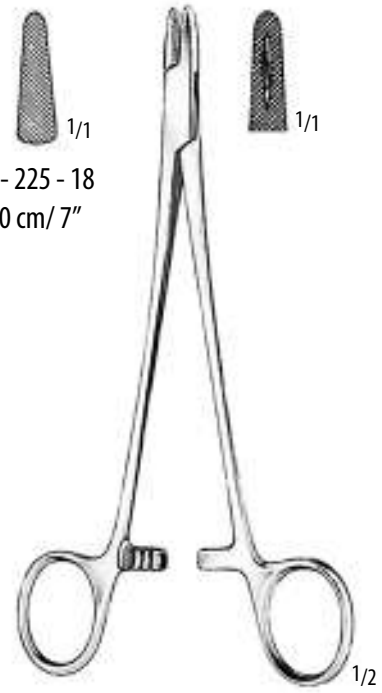

NEW ORLEANS
PO - 226 - 18
18,0 cm / 7"

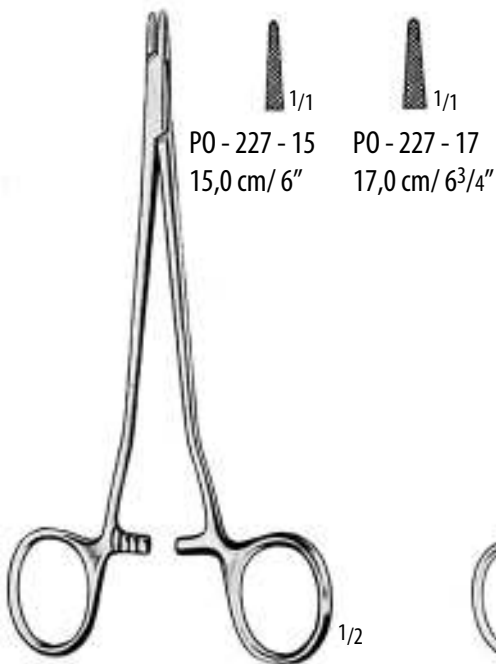

SENNING
(Schwed. Modell)

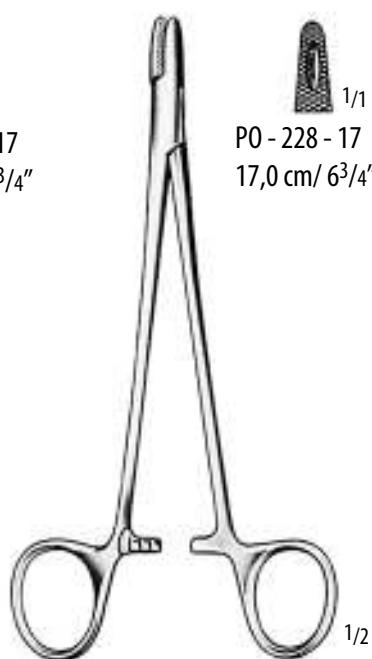

PO - 228 - 17
17,0 cm / 6³/₄"



ADSON
PO - 229 - 18
18,0 cm / 7"



MAYO-HEGAR

1/3



1/1

PO - 230 - 14
14,0 cm/5¹/₂"



1/1

PO - 230 - 16
16,0 cm/6¹/₄"



1/1

PO - 230 - 18
18,0 cm/7"



1/1

PO - 230 - 20
20,0 cm/8"



1/1

PO - 230 - 24
24,0 cm/9¹/₂"



1/1

PO - 230 - 26
26,0 cm/10¹/₄"



1/1

PO - 230 - 30
30,0 cm/12"

MAYO-HEGAR-DELICATE



1/1

PO - 231 - 16
16,0 cm/6¹/₄"



1/1

PO - 231 - 18
18,0 cm/7"



1/1

PO - 231 - 20
20,0 cm/8"

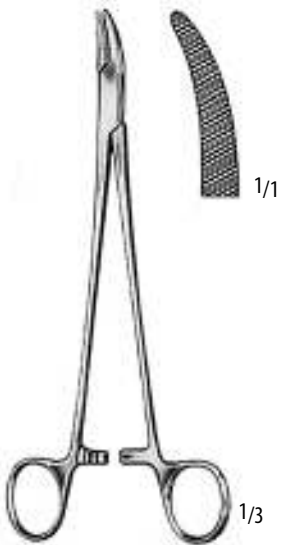

HEANEY

PO - 232 - 21
21,0 cm/8¹/₄"

1/3



1/1



JAMESON

PO - 233 - 23
23,5 cm/9¹/₄"

1/3



1/1



MASSON

PO - 234 - 27
27,0 cm/10¹/₂"

1/3



1/1



FINOCCHIETTO
PO - 235 - 27
27,0 cm/10¹/₂"

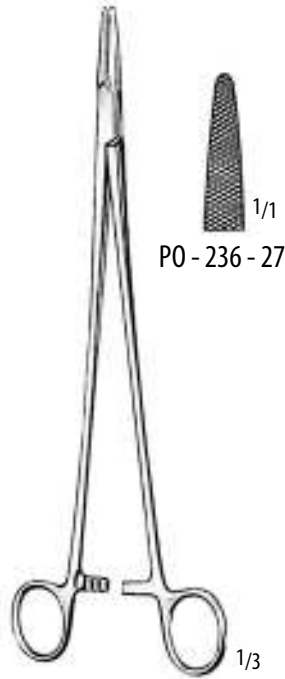

WANGENSTEEN
27,0 cm/10¹/₂"

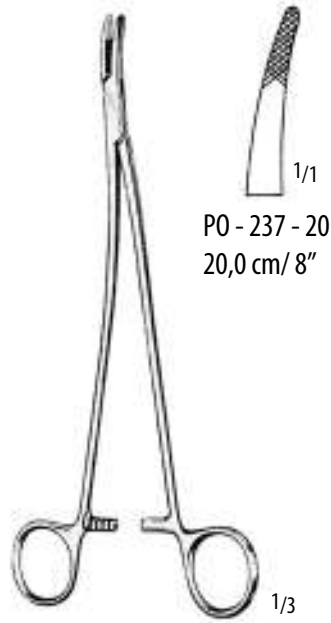

PO - 237 - 20
20,0 cm/ 8"

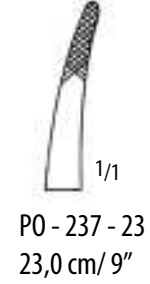

PO - 237 - 23
23,0 cm/ 9"



WERTHEIM
20,0 cm/8" = PO - 238 - 20
24,0 cm/9¹/₂" = PO - 238 - 24

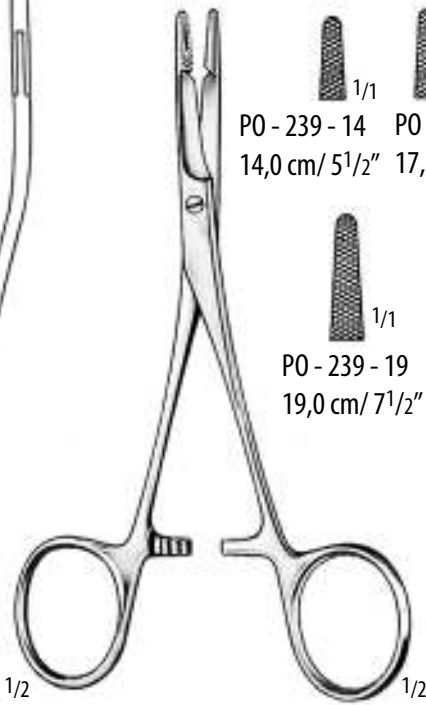

OLSEN-HEGAR

PO - 239 - 14 14,0 cm/ 5¹/₂"
PO - 239 - 17 17,0 cm/ 6³/₄"

PO - 239 - 19
19,0 cm/ 7¹/₂"





GILLIES
PO - 240 - 16
16,0 cm/ 6¹/₄"



MATHIEU

 1/1
 PO - 241 - 14
 14,0 cm/5¹/₂"

 1/1
 PO - 241 - 17
 17,0 cm/6³/₄"

 1/1
 PO - 241 - 20
 20,0 cm/8"

 1/1
 PO - 241 - 24
 24,0 cm/9¹/₂"

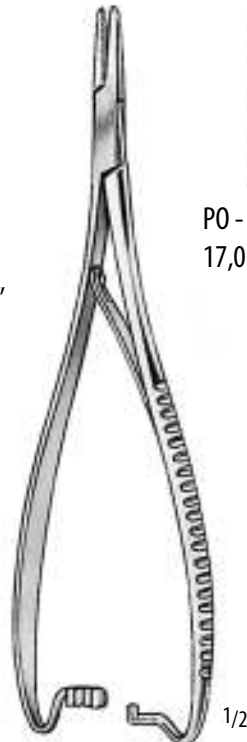

MATHIEU-DELICATE

 1/1
 PO - 242 - 14
 14,0 cm/5¹/₂"

 1/1
 PO - 242 - 17
 17,0 cm /6³/₄"



MATHIEU

 1/1
 PO - 243 - 17
 17,0 cm/6³/₄"

 1/1
 PO - 243 - 20
 20,0 cm/8"

 1/1
 PO - 243 - 24
 24,0 cm/9¹/₂"



 1/1
PO - 244 - 20
20,0 cm / 8"

 1/1
PO - 244 - 25
25,0 cm / 10"

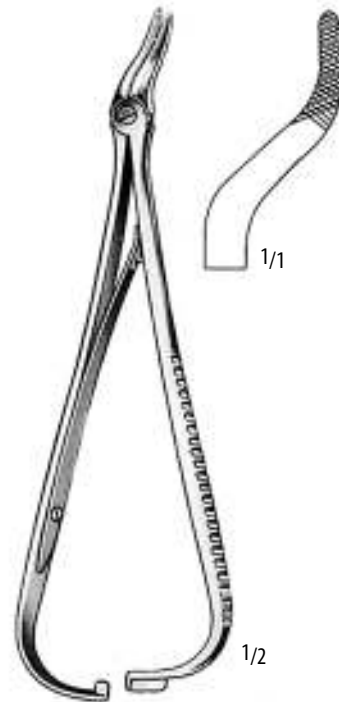

EISELSBERG-MATHIEU
PO - 245 - 18
18,5 cm / 7¹/₄"



 1/1
PO - 246 - 20
20,0 cm / 8"

 1/1
PO - 246 - 23
23,0 cm / 8"



CRILE
PO - 247 - 15
15,0 cm / 6"



TOENNIS
PO - 248 - 18
18,0 cm/7"



LANGENBECK

PO-249-16 16,0 cm/6¹/₄"
PO-249-18 18,0 cm/7"
PO-249-20 20,0 cm/8"



HÖSEL
PO - 250 - 25
25,0 cm/10"



YOUNG-MILLIN
PO - 280 - 20



YOUNG-HRYNTSCHAK
PO - 280 - 24



PO - 281 - 01



PO - 281 - 02



PO - 281 - 03

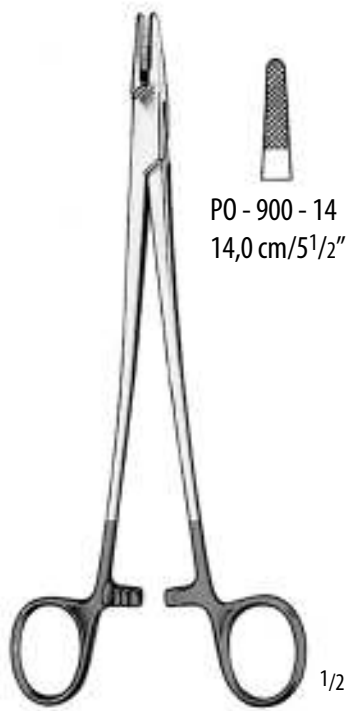

MAYO-HEGAR

PO - 900 - 14
14,0 cm/5¹/₂"

PO - 900 - 16
16,0 cm/6¹/₄"

PO - 900 - 18
18,0 cm/7"

PO - 900 - 20
20,0 cm/8"

PO - 900 - 24
24,0 cm/9¹/₂"

PO - 900 - 26
26,0 cm/10¹/₄"

PO - 900 - 30
30,0 cm/12"



**DE BAKEY
(MAYO-HEGAR-DELICATE)**

PO - 901 - 18
18,0 cm/7"

PO - 901 - 20
20,0 cm/8"

PO - 901 - 23
23,0 cm/9"

PO - 901 - 26
26,0 cm/10¹/₄"

PO - 901 - 31
31,0 cm/12¹/₄"



PO - 902 - 13
13,0 cm/5"



PO - 902 - 15
15,0 cm/6"



PO - 902 - 18
18,0 cm/7"



PO - 902 - 20
20,0 cm/8"



PO - 902 - 23
23,0 cm/9"



PO - 902 - 26
26,0 cm/10¹/₄"

MICRO RYDER



PO - 903 - 13
13,0 cm/5"



PO - 903 - 15
15,0 cm/6"



PO - 903 - 18
18,0 cm/7"



PO - 903 - 20
20,0 cm/8"



PO - 903 - 23
23,0 cm/9"



PO - 903 - 26
26,0 cm/10¹/₄"

1/2



PO - 904 - 14
14,0 cm/5¹/₂"



PO - 904 - 18
18,0 cm/7"



PO - 904 - 20
20,0 cm/8"



PO - 904 - 23
23,0 cm/9"

1/1



PO - 905 - 14
14,0 cm/5¹/₂"



PO - 905 - 18
18,0 cm/7"



PO - 905 - 20
20,0 cm/8"



PO - 905 - 23
23,0 cm/9"

1/1



1/2

EUFRATE PASQUÉ

MICROVASCULAR

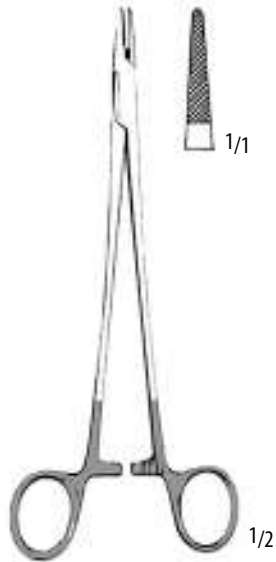

CARROLL
PO - 906 - 15
15,0 cm/6"

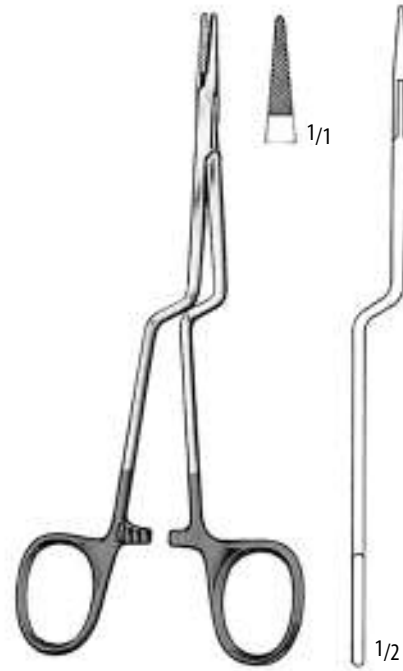

JACOBSON
PO - 907 - 18
18,0 cm/7"



NEW ORLEANS
PO - 908 - 18
18,0 cm/7"

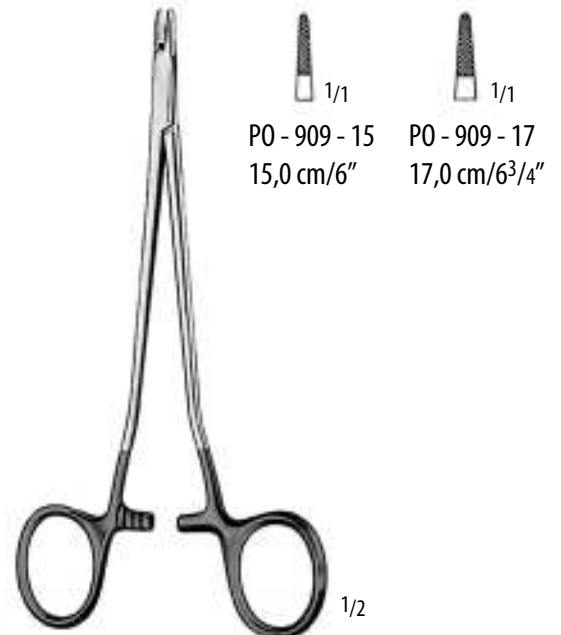

**SENNING
(SWED. PATTERN)**

PO - 909 - 15
15,0 cm/6"

PO - 909 - 17
17,0 cm/6³/₄"

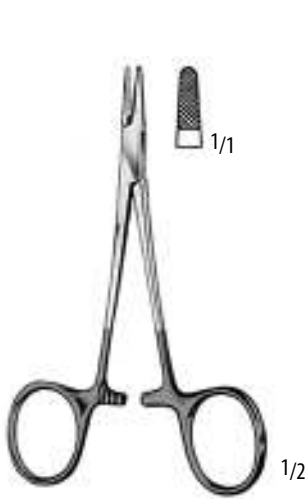

DERF
PO - 910 - 12
12,5 cm/5"



CONVERSE
PO - 911 - 12
12,5 cm/5"

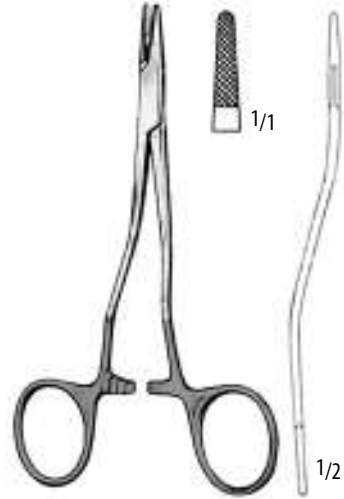

KILNER
PO - 912 - 13
13,5 cm/5 1/4"

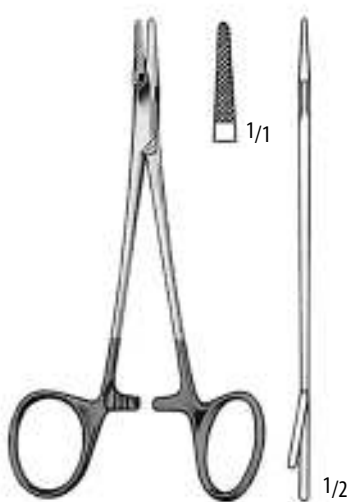

NEIVERT
PO - 913 - 13
13,0 cm/5"



WEBSTER
PO - 914 - 13
13,0 cm/5"

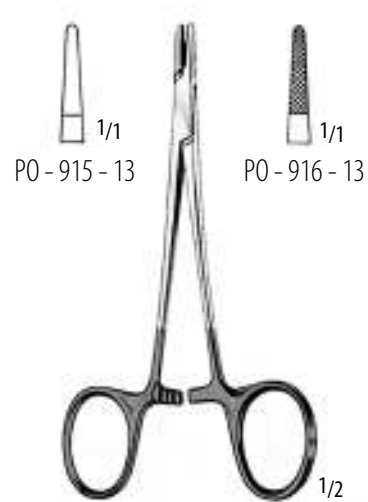

HALSEY
PO - 915 - 13
PO - 916 - 13
13,0 cm/5"

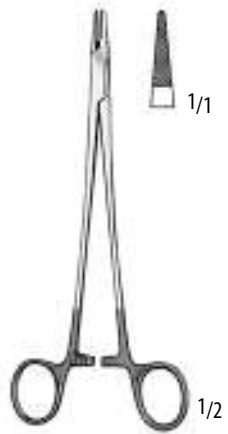

BABY-CRILE-WOOD

PO - 917 - 15
15,0 cm/6"



CRILE-WOOD

PO - 918 - 15
15,0 cm/6"

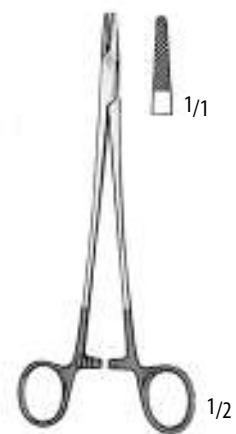

CRILE-WOOD

PO - 919 - 15
15,0 cm/6"



CRILE-WOOD



PO - 920 - 18
18,0 cm/7"



PO - 920 - 20
20,0 cm/8"



PO - 920 - 23
23,0 cm/9"





PO - 921 - 18
18,0 cm/7"



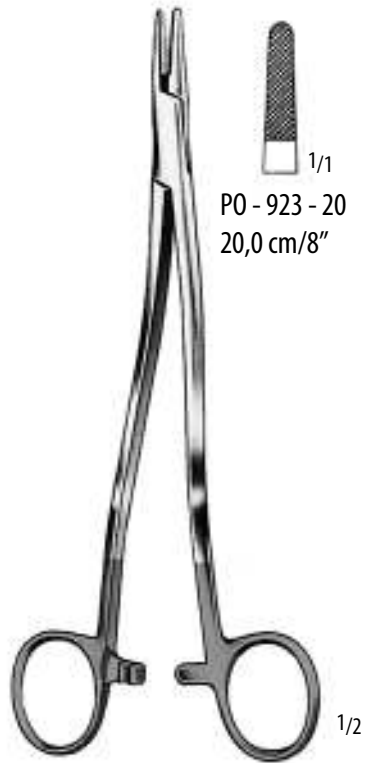

PO - 921 - 23
23,0 cm/9"



- | | | |
|---|---|---|
|  1/1 |  1/1 |  1/1 |
| PO - 923 - 20
20,0 cm/8" | PO - 923 - 24
24,0 cm/9 ¹ / ₂ " | PO - 923 - 30
30,0 cm/12" |

WERTHEIM



- | | | |
|---|---|---|
|  1/1 |  1/1 |  1/1 |
| PO - 924 - 14
14,0 cm/5 ¹ / ₂ " | PO - 924 - 17
17,0 cm/6 ³ / ₄ " | PO - 924 - 19
19,0 cm/7 ¹ / ₂ " |

OLSEN-HEGAR

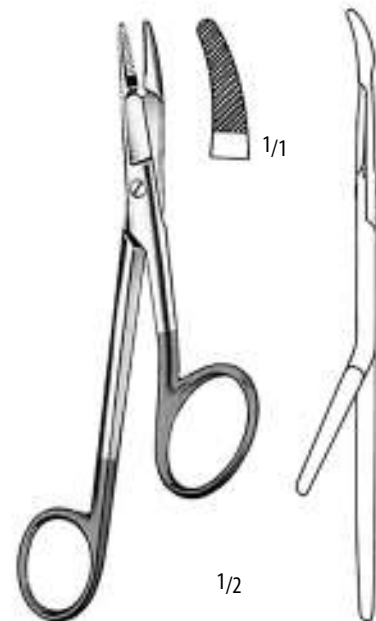

GILLIES

PO - 925 - 16
16,0 cm/6¹/₄"



MATHIEU

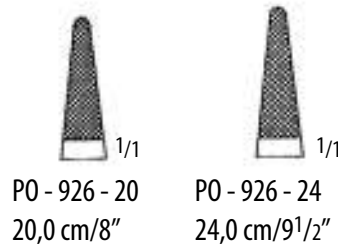
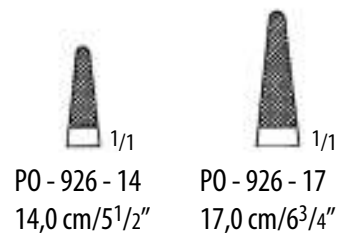

MATHIEU

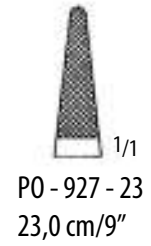
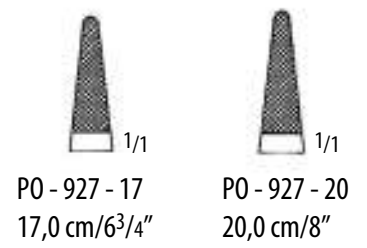

MATHIEU-DELICATE

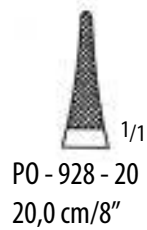
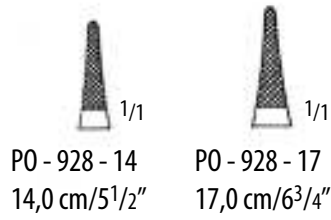

METZENBAUM

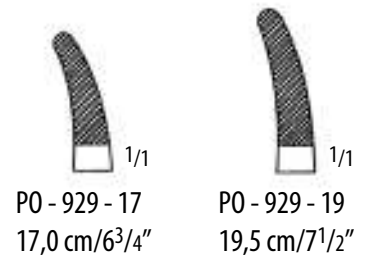

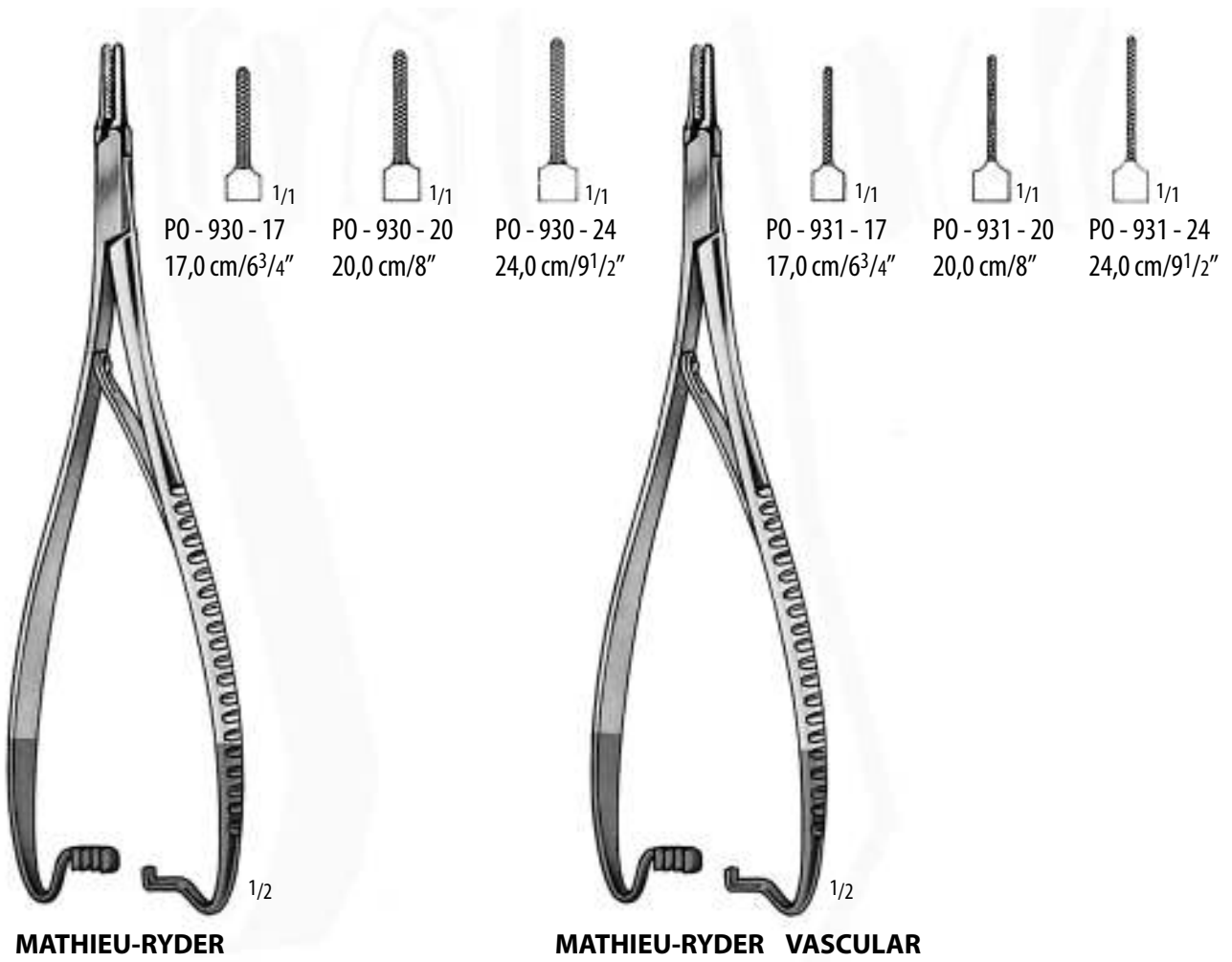

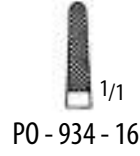
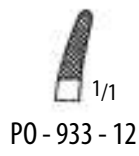
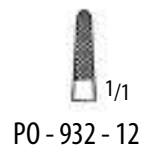

BOYNTON
12,0 cm/4³/₄"

ARRUGA
16,0 cm/6¹/₄"



HÖSEL
PO-936-25
25,0 cm/10"



TOENNIS
PO-937-18
18,0 cm/7"



LICHTENBERG
PO-938-20
20,0 cm/8"

1/1
PO - 939 - 20
20,0 cm/8"



1/1
PO - 939 - 23
23,0 cm/9"

1/2

ZWEIFEL

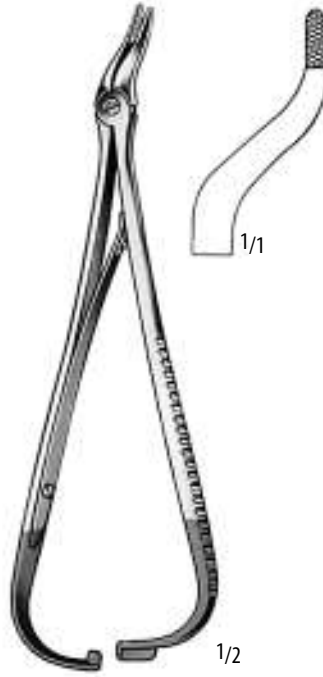

1/1

1/2

EISELSBERG-MATHIEU

PO - 940 - 18
18,5 cm/7¹/₄"



1/1

1/2

LUETHY-BECK

PO - 941 - 20
20,0 cm/8"



1/2



1/1
PO - 942 - 16
16,0 cm/6¹/₄"



1/1
PO - 942 - 18
18,0 cm/7"



1/1
PO - 942 - 20
20,0 cm/8"

LANGENBECK



1/1
PO - 943 - 18
18,0 cm/7"



1/1
PO - 943 - 20
20,0 cm/8"



1/1
PO - 943 - 23
23,0 cm/9"

LANGENBECK-DELICATE



1/1
PO - 944 - 18
18,0 cm/7"



1/1
PO - 944 - 20
20,0 cm/8"



1/1
PO - 944 - 23
23,0 cm/9"

LANGENBECK-RYDER

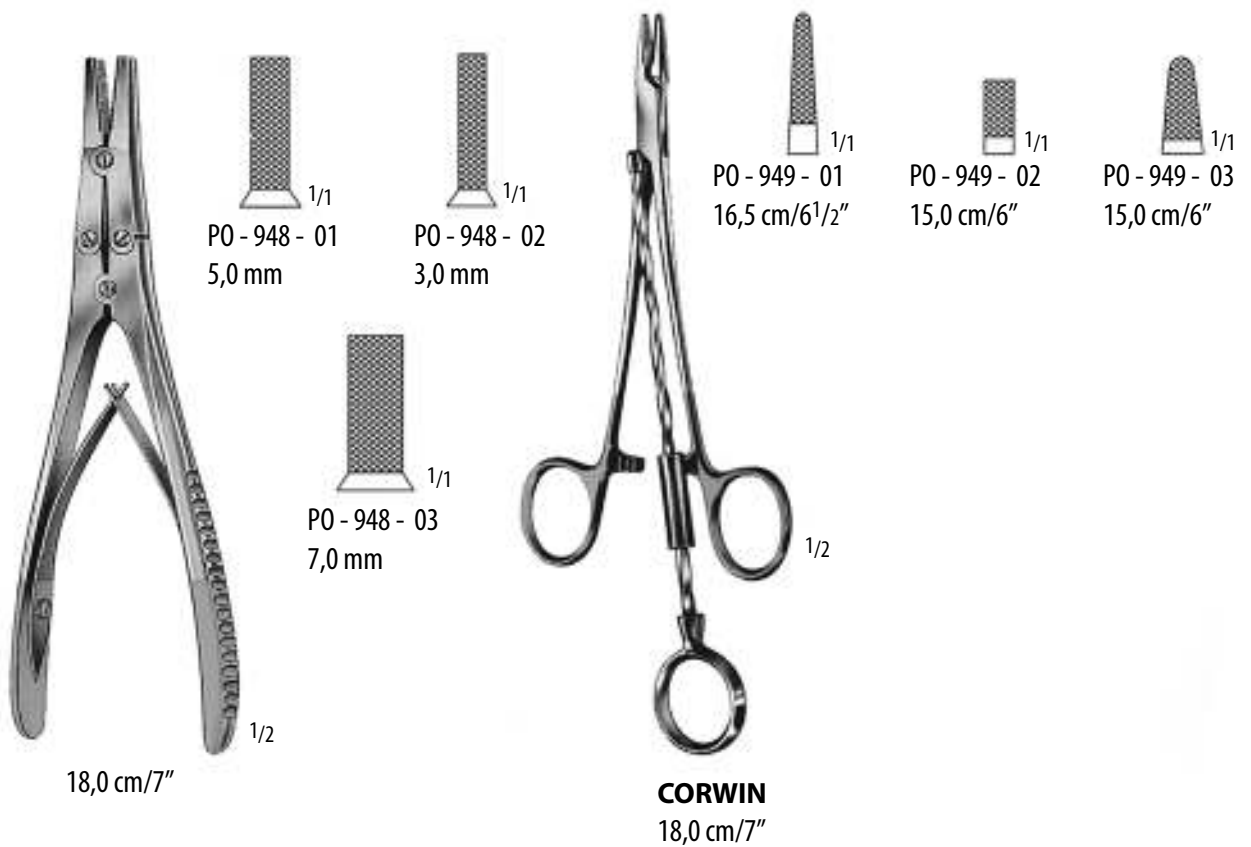
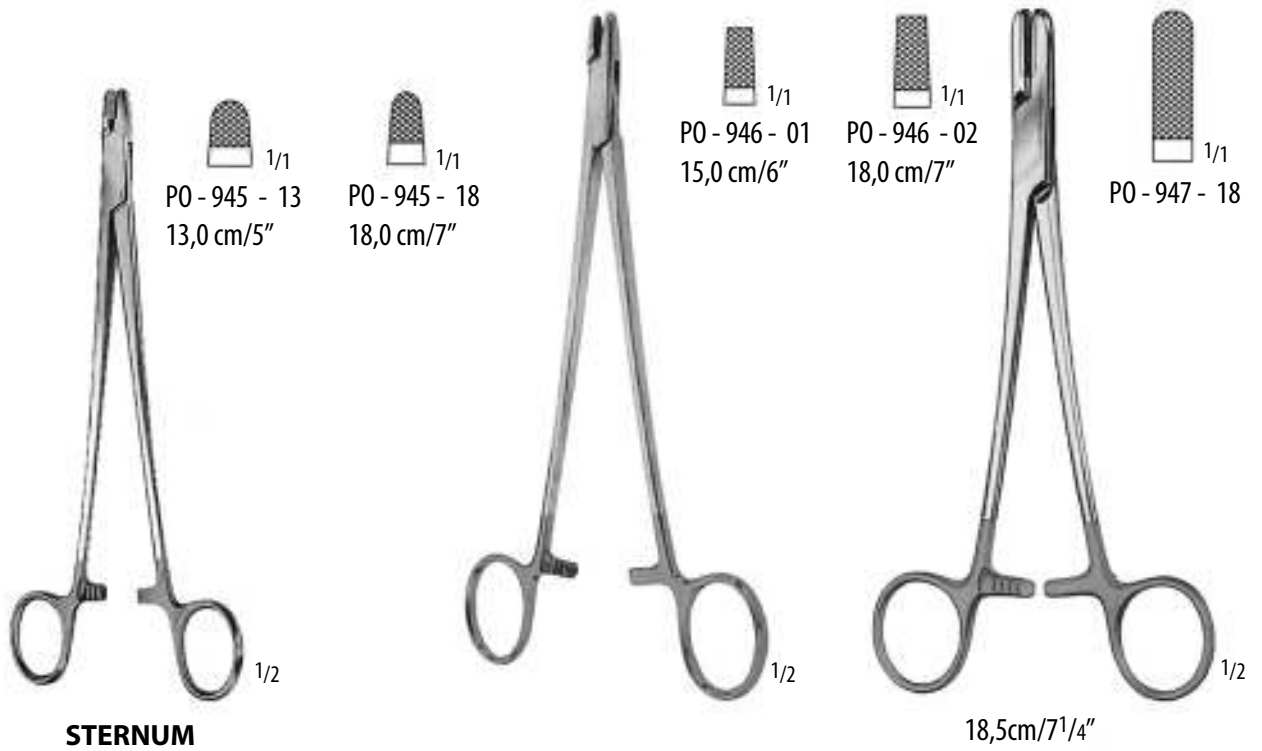



CASTROVIEJO
14,0 cm/5¹/₂"

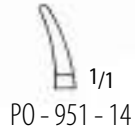
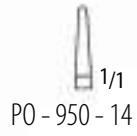

CASTROVIEJO
14,0 cm/5¹/₂"

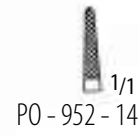

18,0 cm/7"

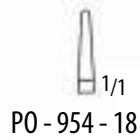

18,0 cm/7"

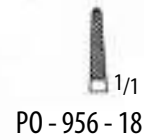



JACOBSON
21,0 cm/8¹/₄"

1/2

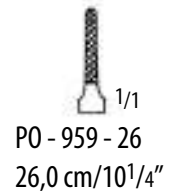
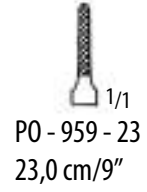
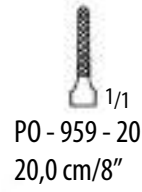
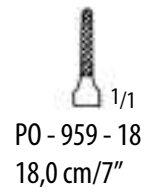
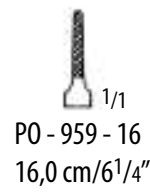

DIETRICH



POTTS-SMITH
PO - 962 - 22

1/2



KALT
PO - 960 - 14

1/2



CASTROVIEJO
PO - 961 - 13

1/2

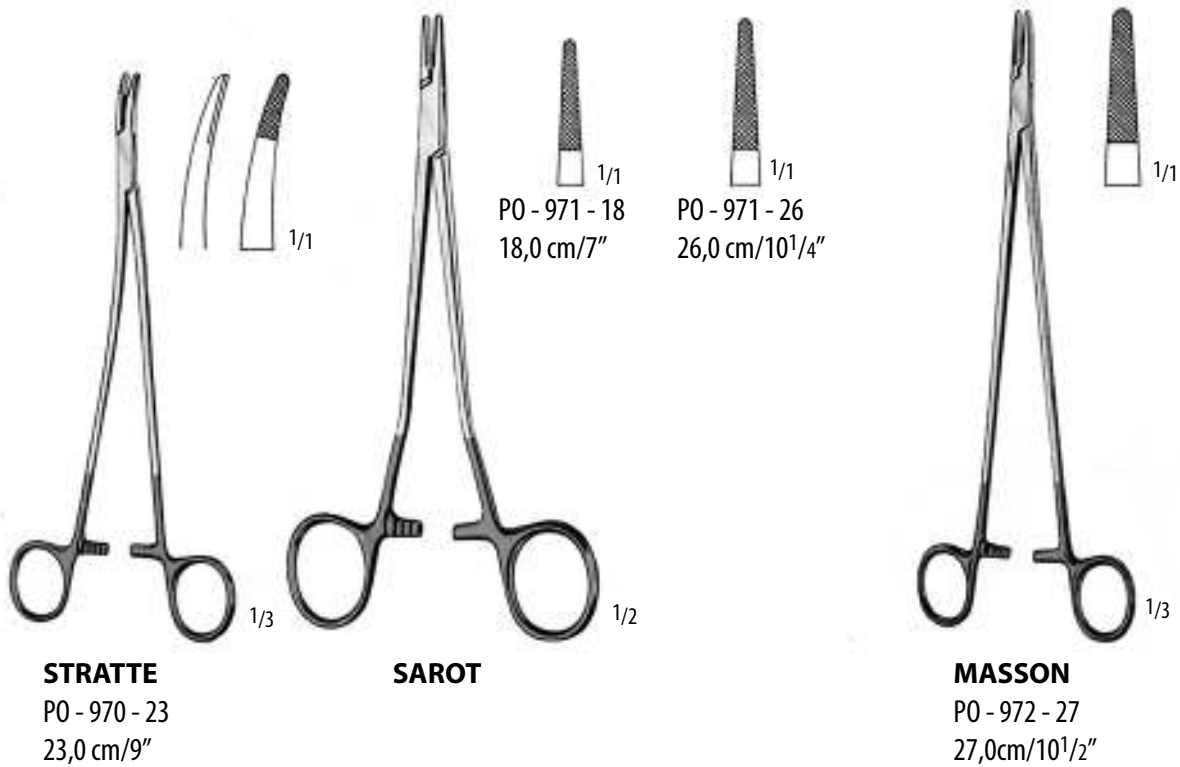
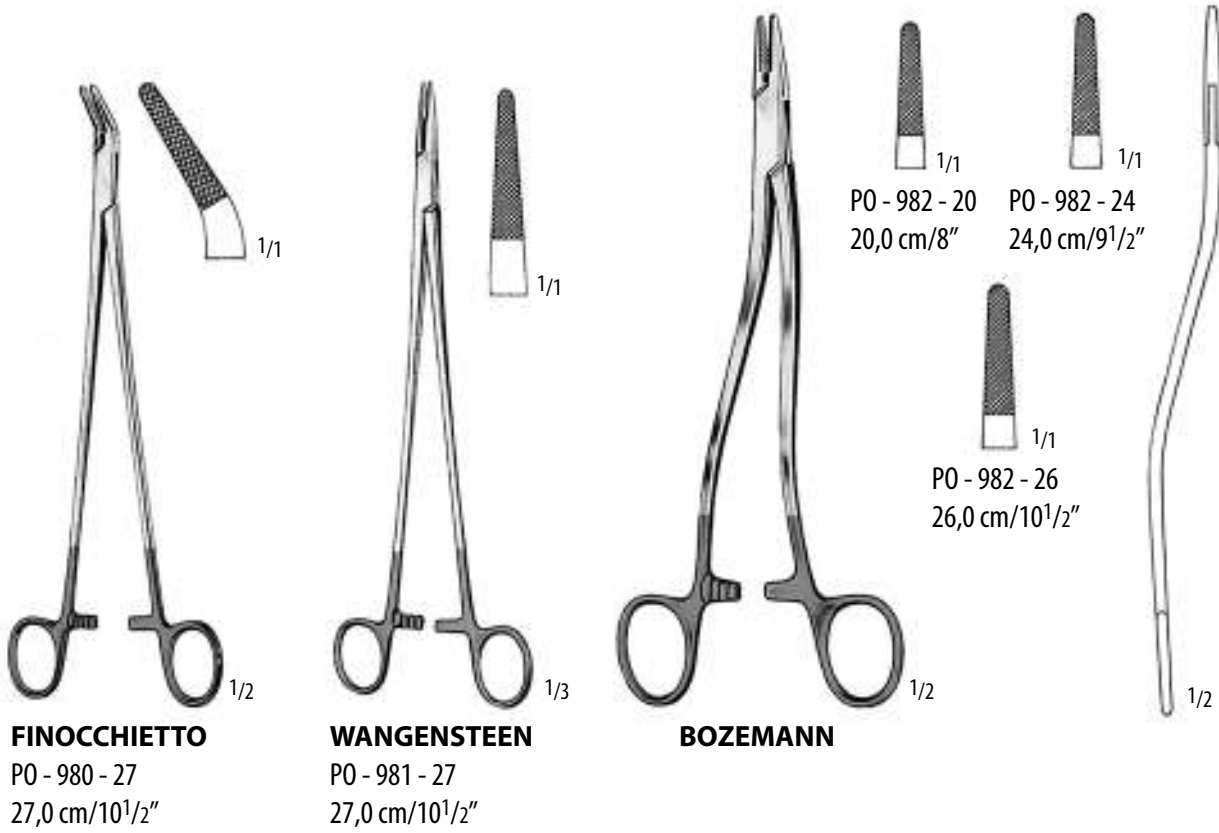



**BARRAQUER-
TROUTMAN**
PO - 100 - 10
10,0 cm/4"



**BARRAQUER-
TROUTMAN**
PO - 101 - 10
10,0 cm/4"



**BARRAQUER-
TROUTMAN**
PO - 102 - 10
10,0 cm/4"



**BARRAQUER-
TROUTMAN**
PO - 103 - 10
10,0 cm/4"



BARRAQUER
PO - 104 - 11
11,0 cm/4¹/₄"



BARRAQUER
PO - 104 - 13
13,0 cm/5"



BARRAQUER
PO - 104 - 14
14,0 cm/5¹/₂"



BARRAQUER
PO - 105 - 14
14,0 cm/5¹/₂"



BARRAQUER
PO - 106 - 14
14,0 cm/5¹/₂"



TROUTMAN
PO - 107 - 01
12,0 cm/4³/₄"



TROUTMAN
PO - 107 - 02
12,0 cm/4³/₄"



PO - 108 - 15

PO - 109 - 15

REIL
15,0 cm/6"



PO - 110 - 15

PO - 111 - 15

REIL
15,0 cm/6"



PO - 112 - 14
14,0 cm/5¹/₂"



PO - 113 - 14
14,0 cm/5¹/₂"



PO - 114 - 14
14,0 cm/5¹/₂"





PO - 119 - 09

PO - 120 - 09

CASTROVIEJO
9,0 cm/3¹/₂"



PO - 121 - 09

PO - 122 - 09

CASTROVIEJO
9,0 cm/3¹/₂"

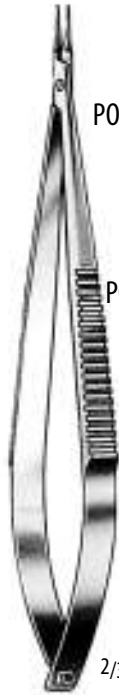

PO - 123 - 14 PO - 124 - 14

PO - 125 - 14 PO - 126 - 14

CASTROVIEJO
14,0 cm/5¹/₂"



PO - 127 - 14 PO - 128 - 14

PO - 129 - 14 PO - 130 - 14

CASTROVIEJO
14,0 cm/5¹/₂"



PO - 131 - 14 PO - 132 - 14

CASTROVIEJO
14,0 cm/5¹/₂"



PO - 133 - 14 PO - 134 - 14

CASTROVIEJO
14,0 cm/5¹/₂"



PO - 135 - 18 PO - 135 - 21

JACOBSON



PO - 136 - 16	16,5 cm/6 ¹ / ₂ "	PO - 137 - 16
PO - 136 - 18	18,0 cm/7"	PO - 137 - 18
PO - 136 - 20	20,0 cm/8"	PO - 137 - 20
PO - 136 - 22	22,0 cm/9"	PO - 137 - 22



PATON
PO - 138 - 11
11,0 cm/4¹/₂"



PATON
PO - 139 - 11
11,0 cm/4¹/₂"



ARRUGA
14,0 cm/5¹/₂"

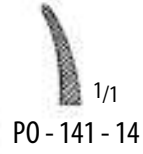
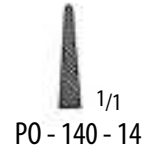

KALT
PO - 142 - 14
14,0 cm/5¹/₂"



KALT-ARRUGA
PO - 143 - 14
14,0 cm/5¹/₂"



CASTROVIEJO-KALT
PO - 144 - 14
13,5 cm/5¹/₂"



STEVENS
PO - 145 - 13 PO - 145 - 15
13,0 cm/5" 15,0 cm/6"



POTTS-SMITH
PO - 146 - 22
22,0 cm/8³/₄"

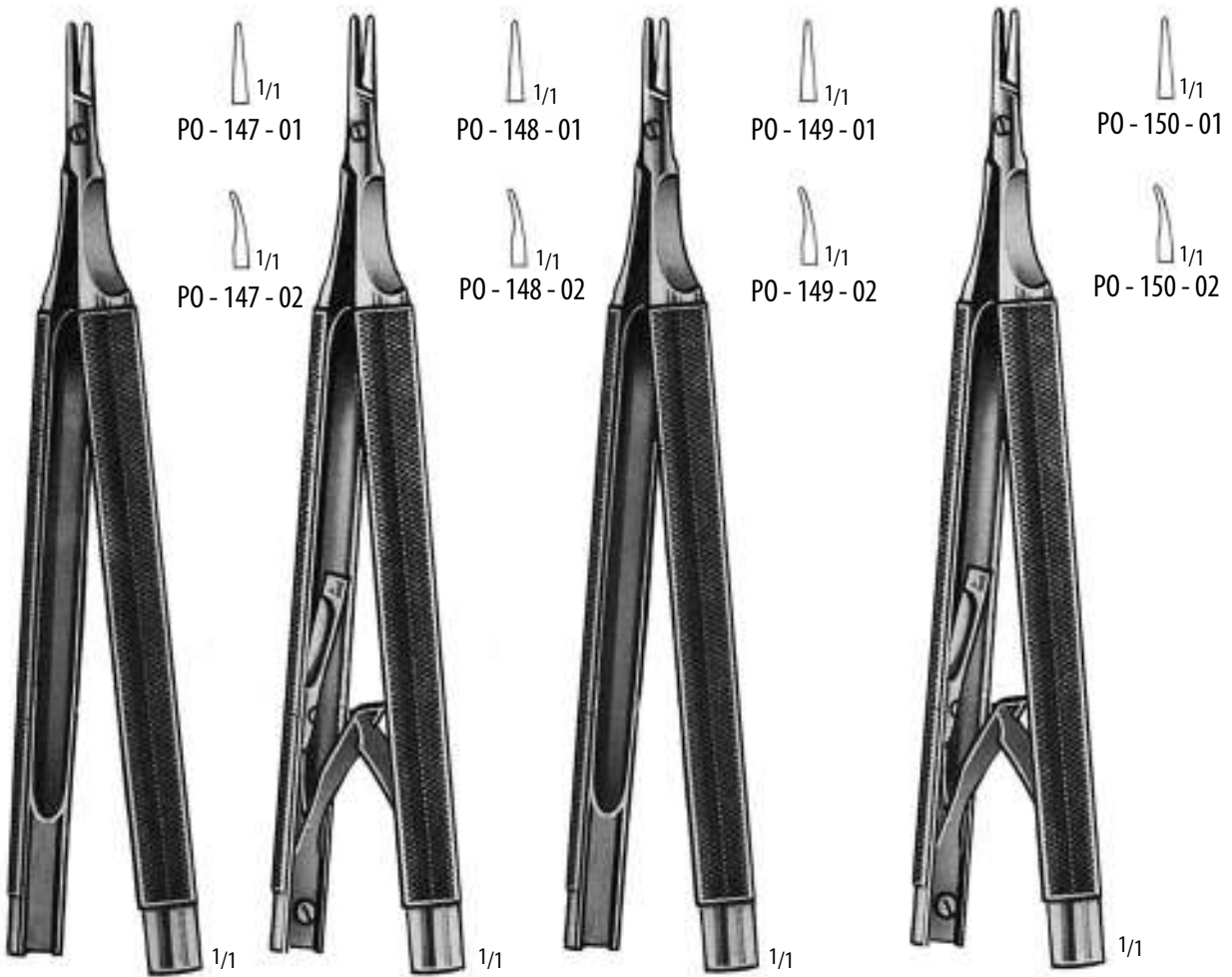

CASTROVIEJO
13,0 cm/5¹/₄"

CASTROVIEJO
13,0 cm/5¹/₄"

CASTROVIEJO
13,0 cm/5¹/₄"

CASTROVIEJO
13,0 cm/5¹/₄"

Handle 8mm Ø

Handle 10mm Ø



1/2

REVERDIN
14,0 cm/5¹/₂"



1/1

Fig. 1
PO - 151 - 01



1/1

2
PO - 151 - 02



1/1

3
PO - 151 - 03



1/1

4
PO - 151 - 04



1/2

REVERDIN
19,5 cm/7³/₄"
22,5 cm/8³/₄"



1/1

Fig. 1
PO - 152 - 01
PO - 153 - 01



1/1

2
PO - 152 - 02
PO - 153 - 02



1/1

3
PO - 152 - 03
PO - 153 - 03



1/1

4
PO - 152 - 04
PO - 153 - 04

DESCHAMPS

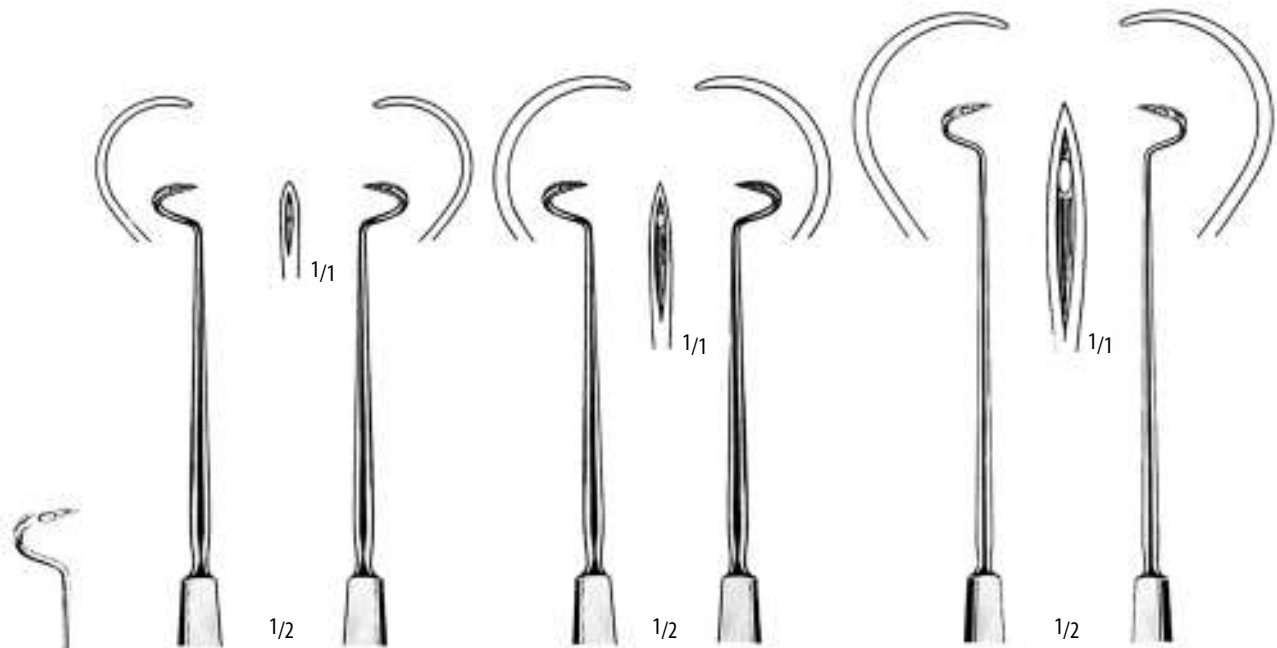

pointed

20,0 cm/8"	PO - 160 - 20	PO - 161 - 20	PO - 162 - 20	PO - 163 - 20		
21,0 cm/8 ¹ / ₄ "					PO - 164 - 21	PO - 165 - 21
27,0 cm/10 ¹ / ₂ "					PO - 164 - 27	PO - 165 - 27

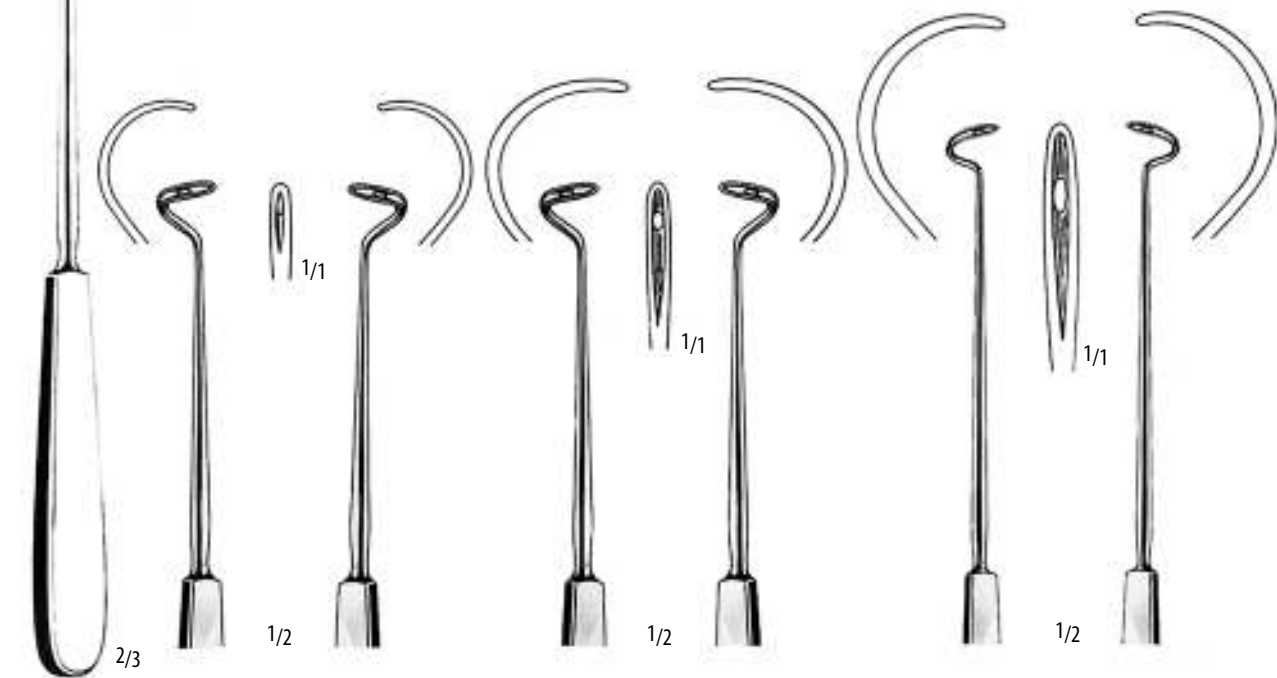

blunt

DESCHAMPS

20,0 cm/8"	PO - 166 - 20	PO - 167 - 20	PO - 168 - 20	PO - 169 - 20		
21,0 cm/8 ¹ / ₄ "					PO - 170 - 21	PO - 171 - 21
27,0 cm/10 ¹ / ₂ "					PO - 170 - 27	PO - 171 - 27

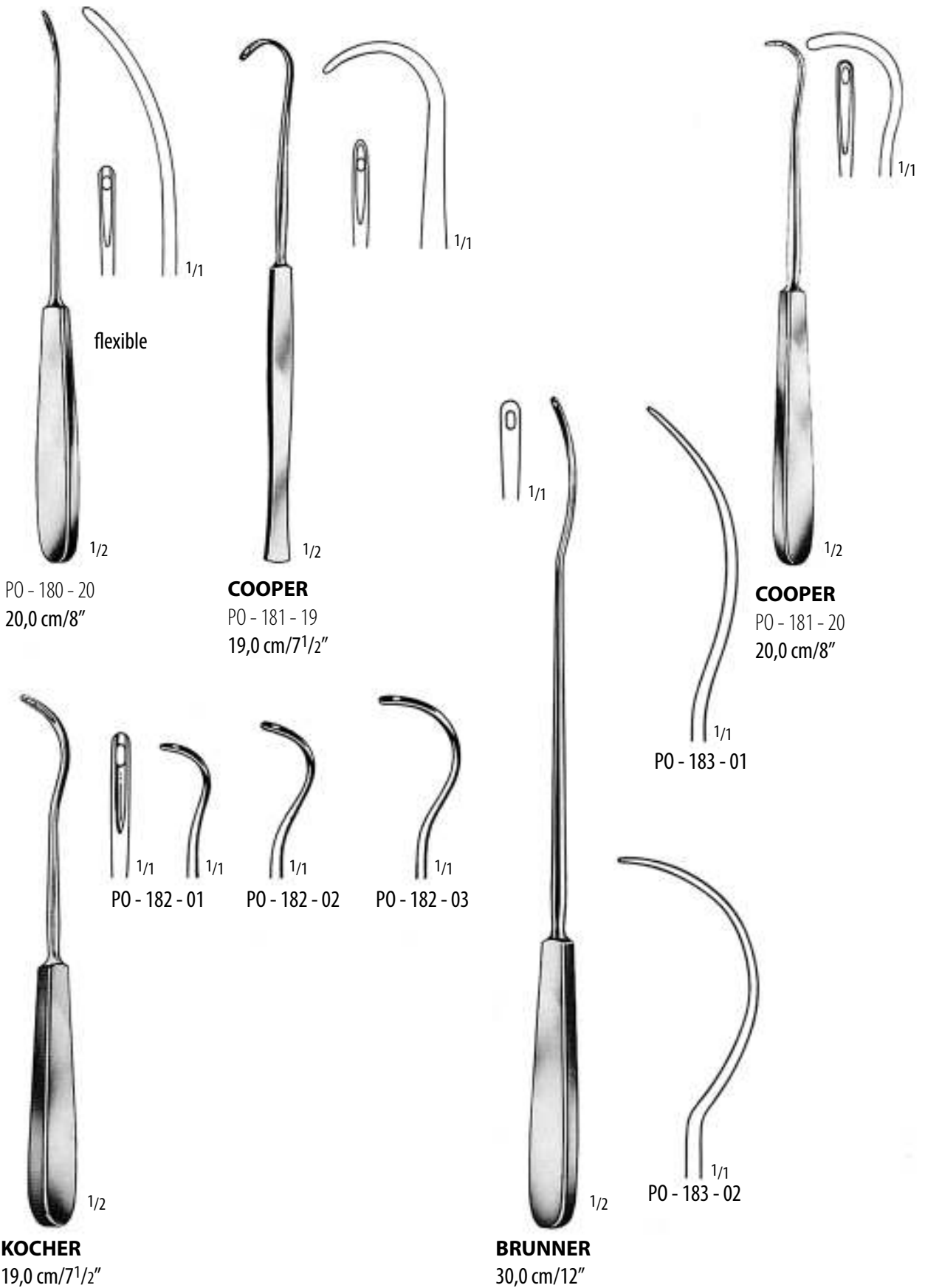

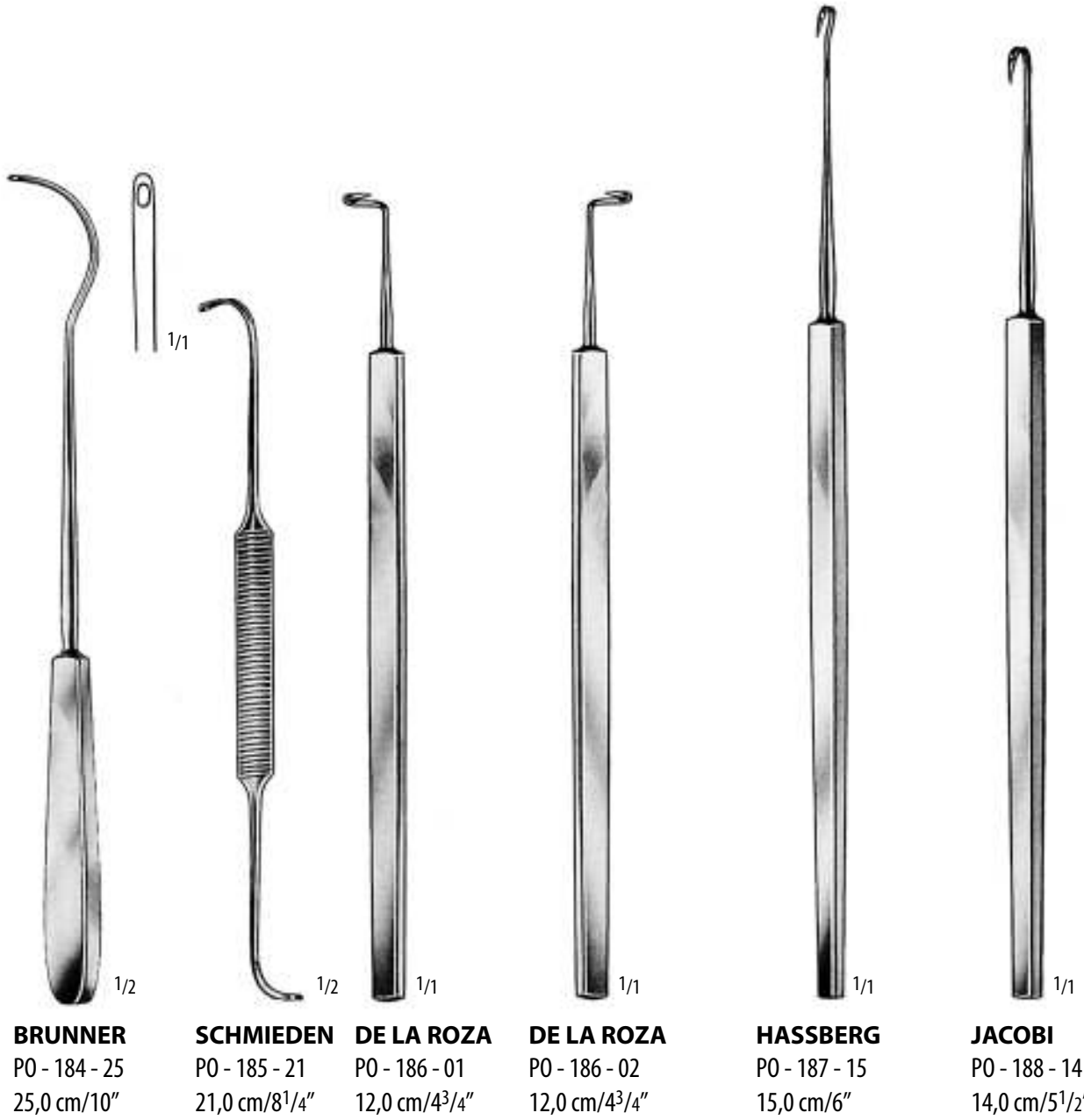

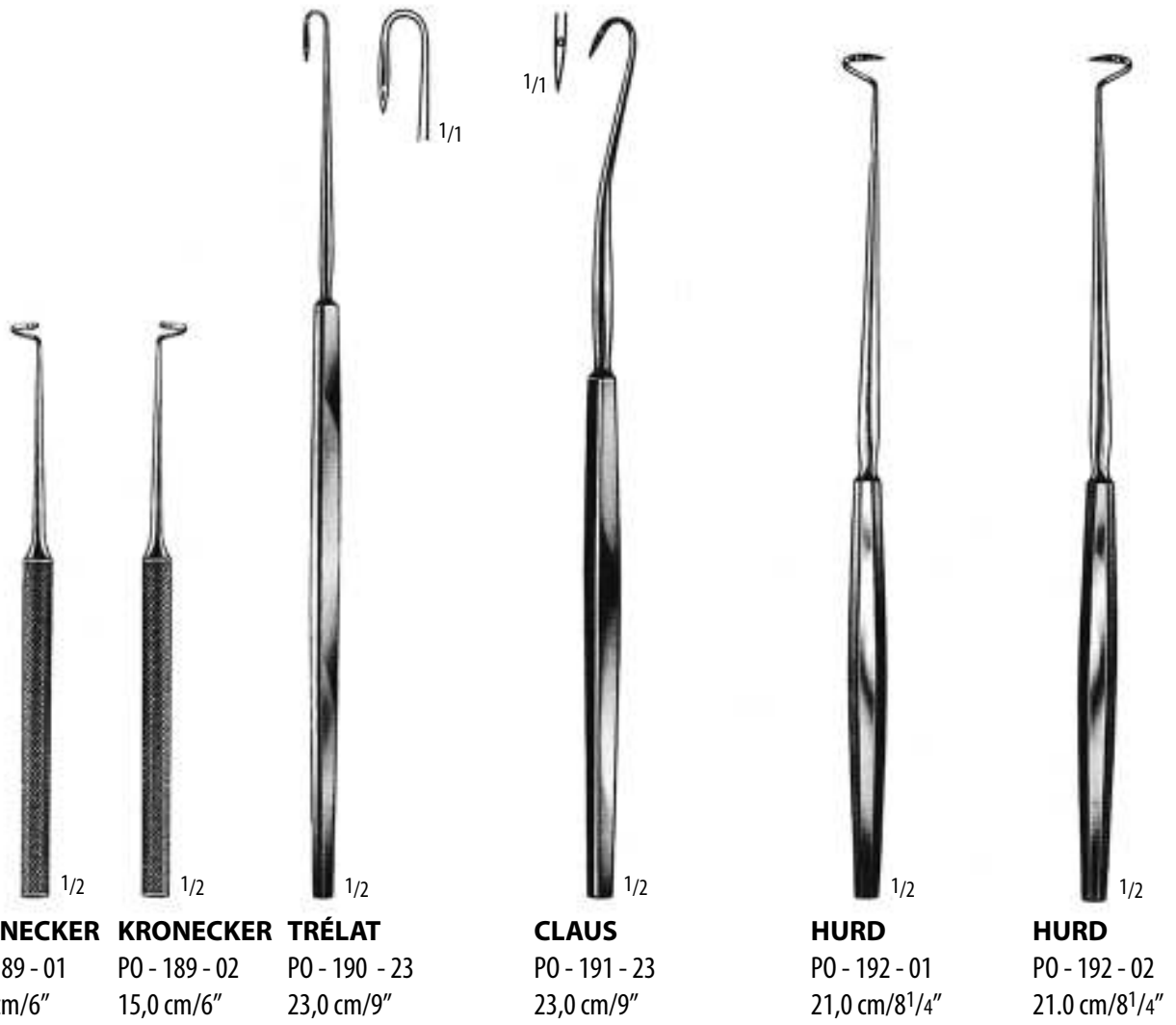

KRONECKER
PO - 189 - 01
15,0 cm/6"

KRONECKER
PO - 189 - 02
15,0 cm/6"

TRÉLAT
PO - 190 - 23
23,0 cm/9"

CLAUS
PO - 191 - 23
23,0 cm/9"

HURD
PO - 192 - 01
21,0 cm/8¹/₄"

HURD
PO - 192 - 02
21.0 cm/8¹/₄"

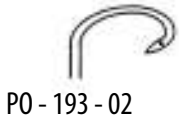

ROTTER
26,0 cm/10¹/₄"



ROTTER
26,0 cm/10¹/₄"



NAGER
PO - 195 - 21
24,0 cm/9¹/₂"



FALK
PO - 196 - 01
24,0 cm/9¹/₂"



FALK
PO - 196 - 02
24,0 cm/9¹/₂"



CLAUS-EICKEN
PO - 197 - 23
23,0 cm/9"



BRUNNER
30,0 cm/12"

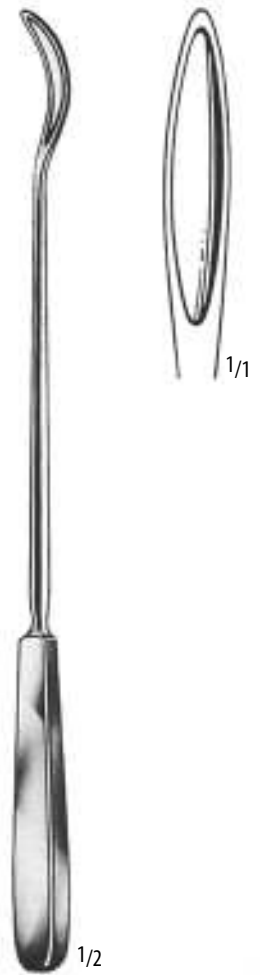

BRUNNER
PO - 199 - 25
25,0 cm/10"



PAYR
PO - 200 - 22
22,0 cm/8³/₄"



PAYR
PO - 201 - 22
22,0 cm/8³/₄"

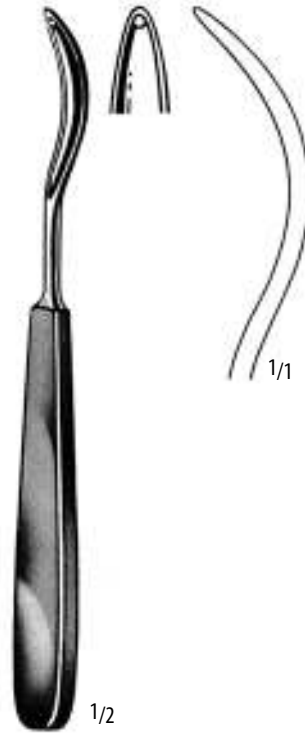

SCHMIEDEN-PAYR
PO - 202 - 19
19,0 cm/7¹/₂"



SCHMIEDEN-PAYR
PO - 203 - 19
19,0 cm/7¹/₂"

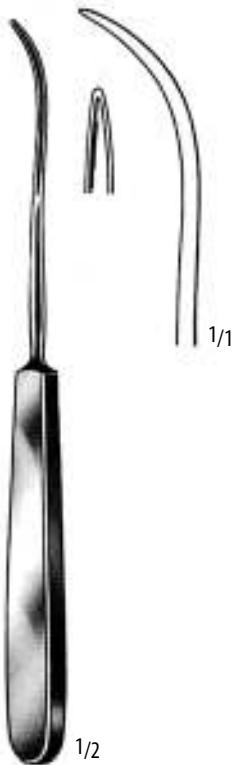

KÖNIG
PO - 204 - 01
19,5 cm/7³/₄"

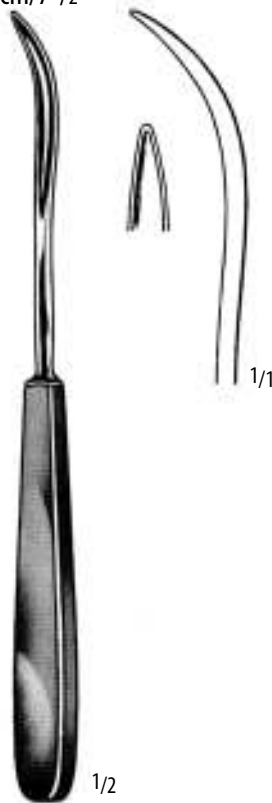

KÖNIG
PO - 204 - 02
19,5 cm/7³/₄"

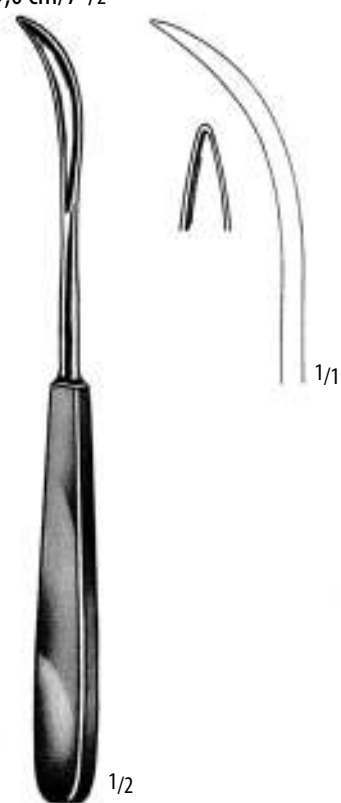

KÖNIG
PO - 204 - 03
19,5 cm/7³/₄"

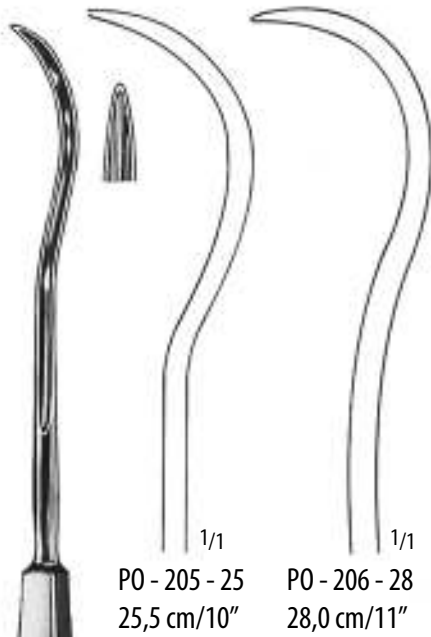

PO - 205 - 25
25,5 cm/10"

PO - 206 - 28
28,0 cm/11"



15,0 cm/6"
16,0 cm/6¹/₄"
18,0 cm/7"



PO - 207 - 15
PO - 207 - 16



PO - 208 - 15
PO - 208 - 16

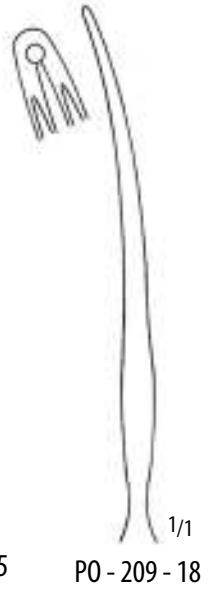

PO - 209 - 18

KOCHER



KIRSCHNER

1/2



1/2

FERROZELL
PO - 210 - 24
24,0 cm/9¹/₂"



1/2

BRUNNER-FERROZELL
PO - 211 - 18 PO - 211 - 27
18,0 cm/7" 27,0 cm/10¹/₂"



1/2

KIRSCHNER-FERROZELL
PO - 212 - 27
27,0 cm/10¹/₂"



1/2

FERROZELL
PO - 213 - 18
18,0 cm/7"

straight

curved



PO - 214 - 23
23,0 cm/9"



BOZEMANN
PO - 215 - 21
21,0 cm/8¹/₄"



MOD.WIEN
PO - 216 - 23
23,5 cm/9¹/₄"



FRIEDRICH
PO - 217 - 16
16,0 cm/6¹/₄"



MICHEL
PO - 218 - 12
12,0 cm/4³/₄"



COLLIN
PO - 219 - 13
13,0 cm/5"



RICHTER-HEATH
PO - 220 - 14
14,0 cm/5¹/₂"



WACHENFELDT
PO - 221 - 12
12,5 cm/5"



HEGENBARTH
PO - 222 - 12
12,5 cm/5"



MICHEL
PO - 223 - 12
12,0 cm/4³/₄"



LANGE
PO - 224 - 10
10,0 cm/4"



CHILDE
PO - 225 - 01
18,0 cm/7"



CHILDE
PO - 225 - 02
18,0 cm/7"

155 mm, 6"

CASPAR

RG - 100 - 02 2 mm



RG - 100 - 03 3 mm



RG - 100 - 04 4 mm



RG - 100 - 05 5 mm



150 °

155 mm, 6"

CASPAR

RG - 101 - 02 2 mm



RG - 101 - 03 3 mm



RG - 101 - 04 4 mm



150 °

155 mm, 6"

CASPAR

RG - 102 - 02 2 mm



RG - 102 - 03 3 mm



RG - 102 - 04 4 mm



CASPAR

length of shaft length of shaft length of shaft size of jaws

140 mm , 5 1/2"	160 mm , 6 1/4"	185 mm , 7 1/4"	
RG - 300 - 14	RG - 310 - 16	RG - 315 - 18	2 x 12 mm
RG - 301 - 14	RG - 311 - 16	RG - 316 - 18	3 x 12 mm
RG - 302 - 14	RG - 312 - 16	RG - 317 - 18	4 x 14 mm
	RG - 313 - 16	RG - 318 - 18	5 x 14 mm
	RG - 314 - 16	RG - 319 - 18	6 x 16 mm

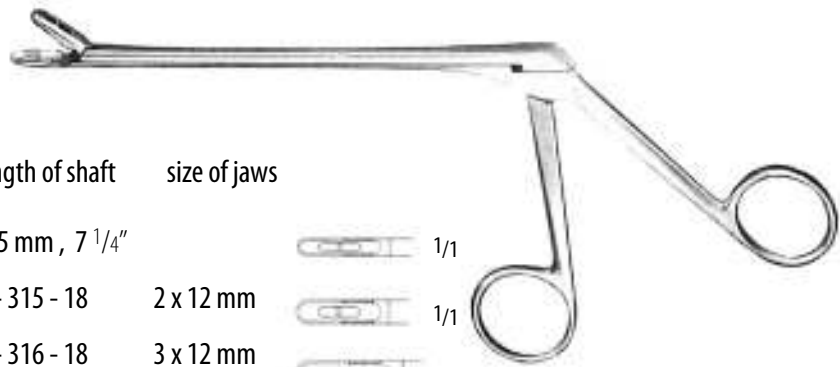
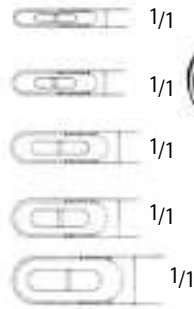

150°

CASPAR

length of shaft length of shaft length of shaft size of jaws

140 mm , 5 1/2"	160 mm , 6 1/4"	185 mm , 7 1/4"	
RG - 330 - 14	RG - 335 - 16	RG - 340 - 18	3 x 12 mm
RG - 331 - 14	RG - 336 - 16	RG - 341 - 18	4 x 14 mm
	RG - 337 - 16	RG - 342 - 18	5 x 14 mm

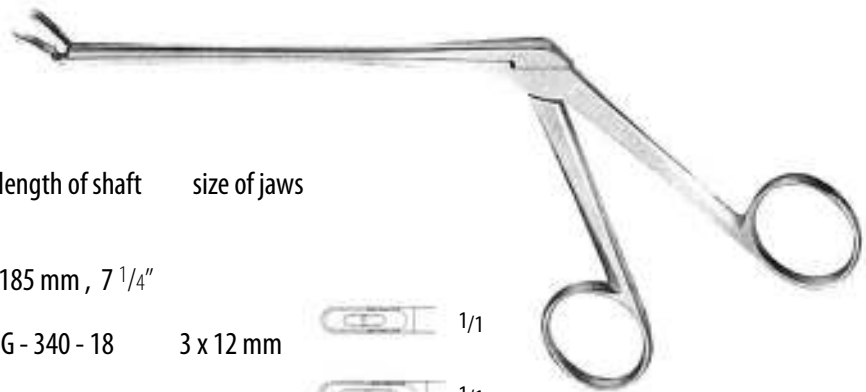
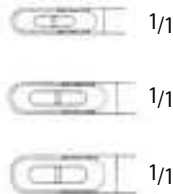

150°

CASPAR

length of shaft length of shaft length of shaft size of jaws

140 mm , 5 1/2"	160 mm , 6 1/4"	185 mm , 7 1/4"	
RG - 350 - 14	RG - 355 - 16	RG - 360 - 18	3 x 12 mm
RG - 351 - 14	RG - 356 - 16	RG - 361 - 18	4 x 14 mm

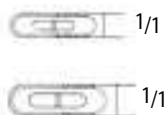

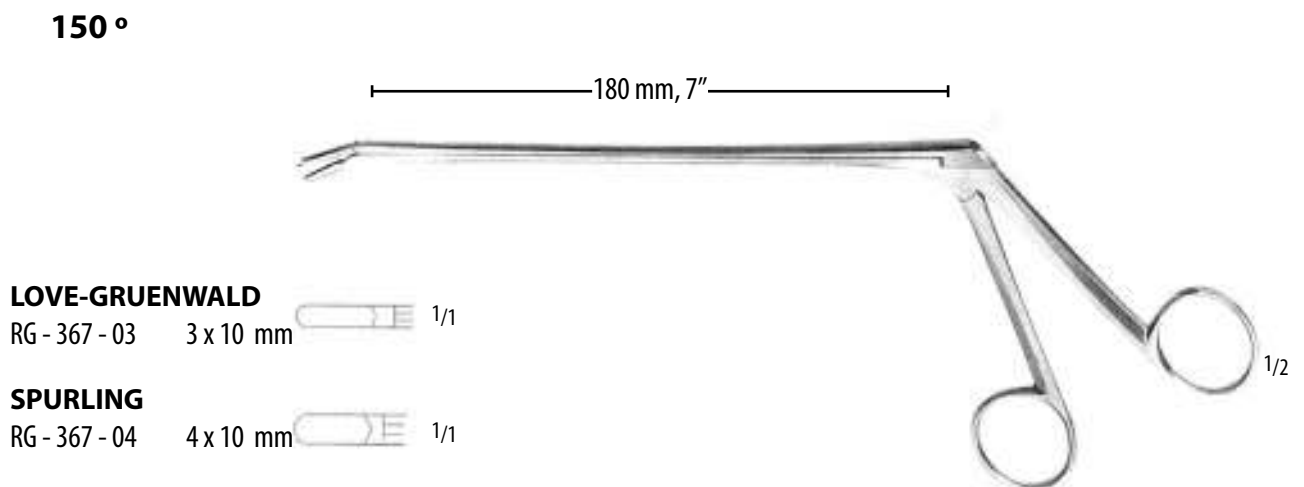
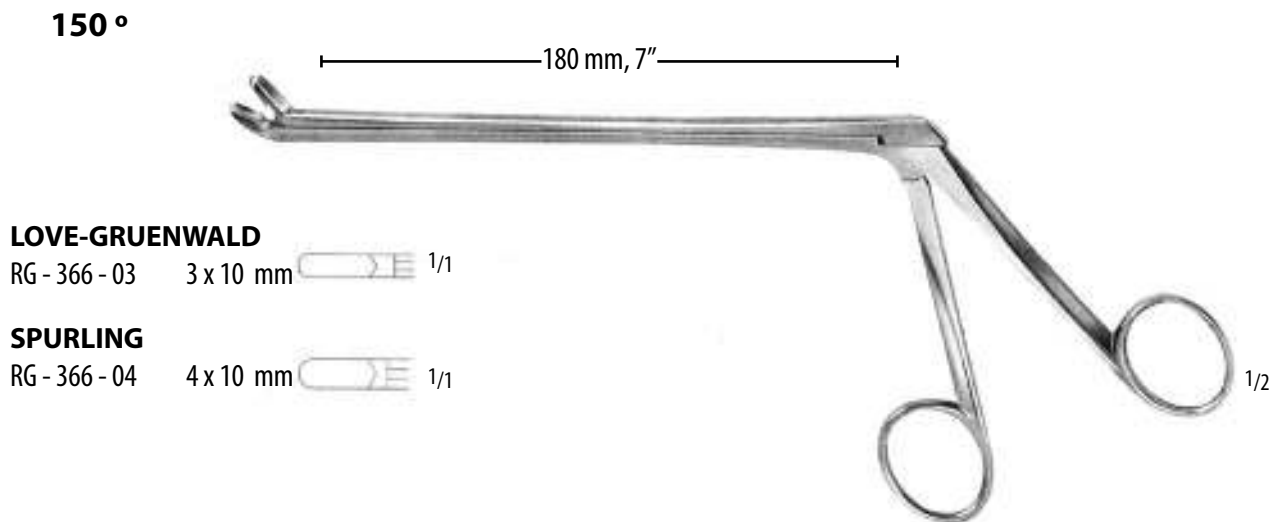
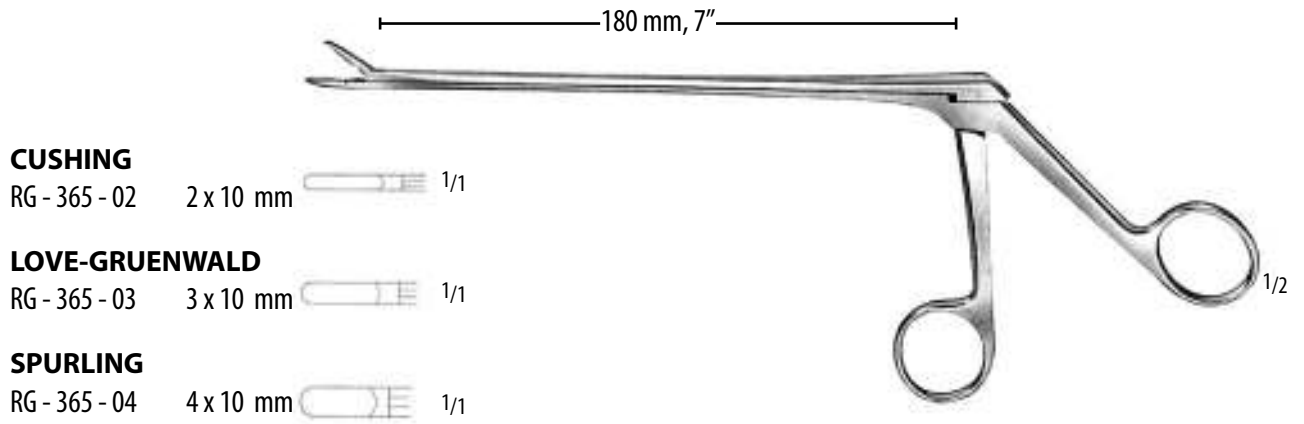

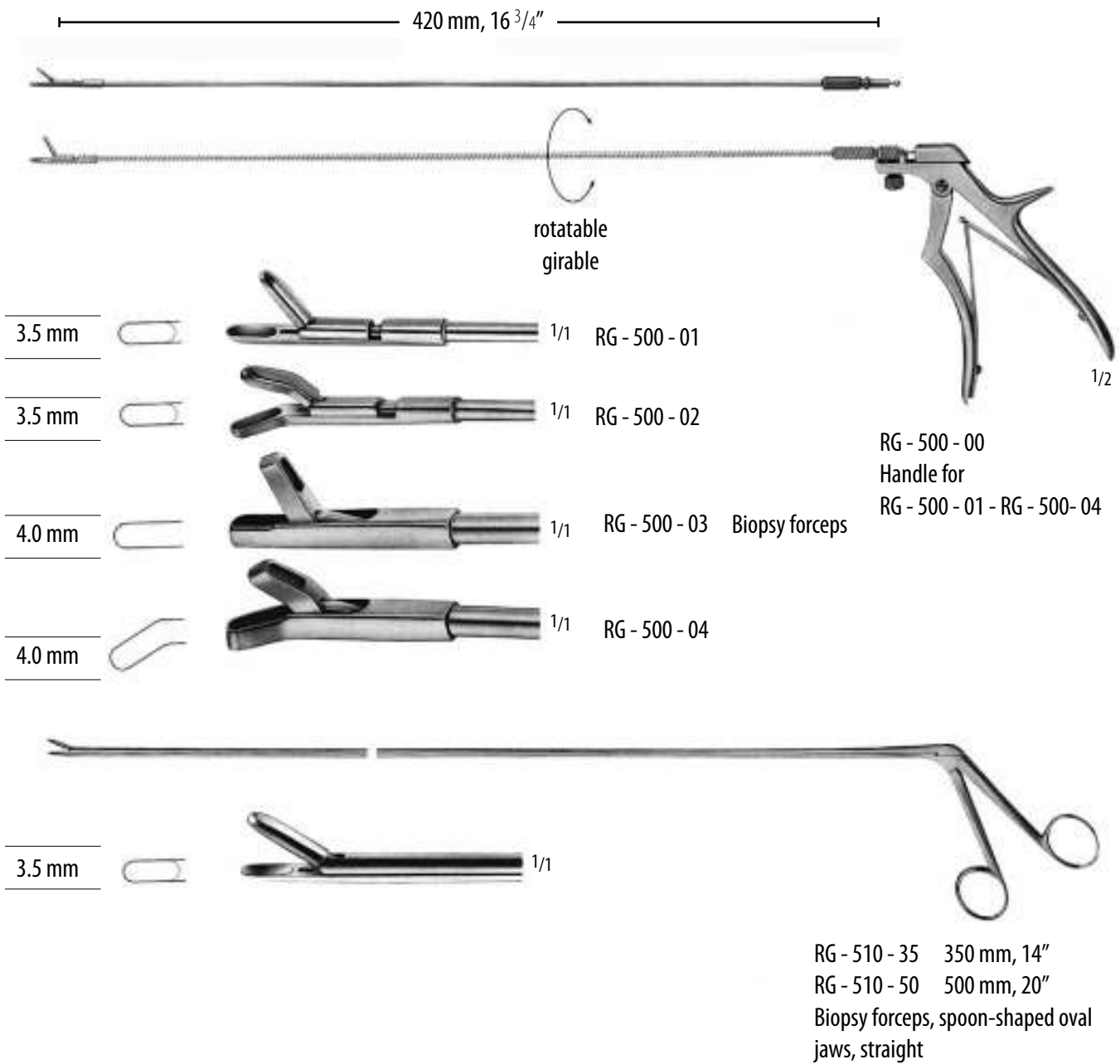



1/2

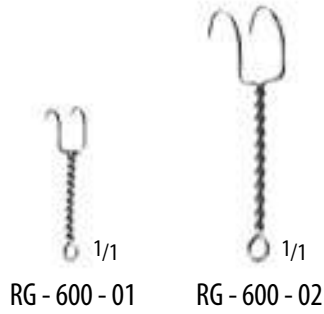

1/1
RG - 600 - 01

1/1
RG - 600 - 02

YASARGIL

RG - 600 - 01 - RG - 600 - 02

Spring hooks for galea fixation with bulldog clamp, to be fastened to covering drape.



1/2

HUDSON

RG - 605 - 00

Hand drill, complete set, consisting of trepanning brace, cerebellar attachment and 4 burs RG - 610 - 09 - RG - 610 - 22



1/2

HUDSON

RG - 610 - 09
Ø 9 mm

HUDSON

RG - 610 - 14
Ø 14 mm

HUDSON

RG - 610 - 16
Ø 16 mm

HUDSON

RG - 610 - 22
Ø 22 mm

ADSON

RG - 610 - 15
Ø 15 mm

MC KENZIE

RG - 610 - 13
Ø 13 mm

CUSHING

RG - 611 - 14
Ø 14 mm

RG - 612 - 02
Ø 2 mm



1/2

11,5 cm / 4 1/2"	1.0 mm	2.0 mm
13,0 cm / 5"	SO - 200 - 11	SO - 201 - 11
14,5 cm / 5 1/2"	SO - 200 - 13	SO - 201 - 13
16,0 cm / 6 1/4"	SO - 200 - 14	SO - 201 - 14
18,0 cm / 7"	SO - 200 - 16	SO - 201 - 16
20,0 cm / 8"	SO - 200 - 18	SO - 201 - 18
25,0 cm / 8"	SO - 200 - 20	SO - 201 - 20
	SO - 200 - 25	SO - 201 - 25



1/2

SO - 202 - 11
SO - 202 - 13
SO - 202 - 14
SO - 202 - 16
SO - 202 - 18
SO - 202 - 20
SO - 202 - 25



1/2

MYRTLE LEAF

SO - 203 - 14
SO - 203 - 16
SO - 203 - 18
SO - 203 - 20

Silver



1/2

STACKE

SO - 204 - 10
10,5 cm / 4 1/4"
Ø 1,0 mm



1/2

11,5 cm / 4 1/2"	SO - 205 - 11
13,0 cm / 5"	SO - 205 - 13
14,5 cm / 5 1/2"	SO - 205 - 14
16,0 cm / 6 1/4"	SO - 205 - 16
18,0 cm / 7"	SO - 205 - 18
20,0 cm / 8"	SO - 205 - 20



1/2

DOYEN

SO - 206 - 14



1/2

SO - 207 - 11
SO - 207 - 13
SO - 207 - 14
SO - 207 - 16
SO - 207 - 18



1/2

NÉLATON

SO - 208 - 16



BRODIE
SO - 209 - 20
20,0 cm / 8"



SO - 210 - 01
Fig. 1



SO - 210 - 02
Fig. 2

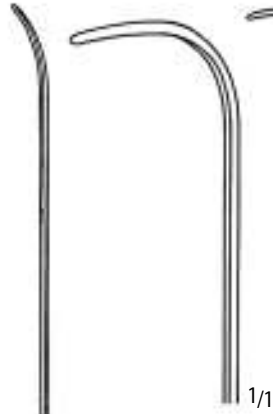

SO - 210 - 03
Fig. 3



SO - 210 - 04
Fig. 4



FARRELL

	0,9 mm	1,1 mm	1,2 mm
12,0 cm / 4 ³ / ₄ "	SO - 211 - 12		
14,0 cm / 5 ¹ / ₂ "	SO - 211 - 14		
16,5 cm / 6 ¹ / ₂ "		SO - 211 - 16	
18,0 cm / 7"		SO - 211 - 18	



FARRELL

	0,9 mm	1,1 mm	1,2 mm
	SO - 212 - 12		
	SO - 212 - 14		
		SO - 212 - 16	
		SO - 212 - 18	



UCKERMANN
SO - 213 - 16
16,0 cm / 6 1/4"



JOBSON-HORNE
SO - 214 - 18
18,0 cm / 7"

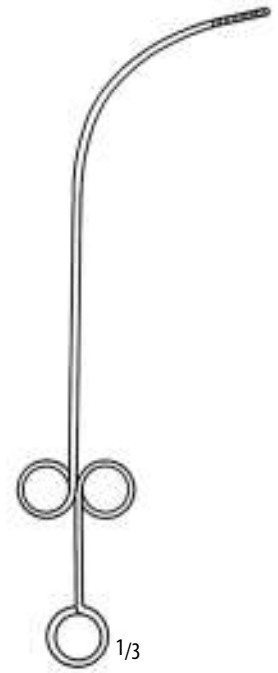

FEIN
SO - 215 - 28
28,0 cm / 11"

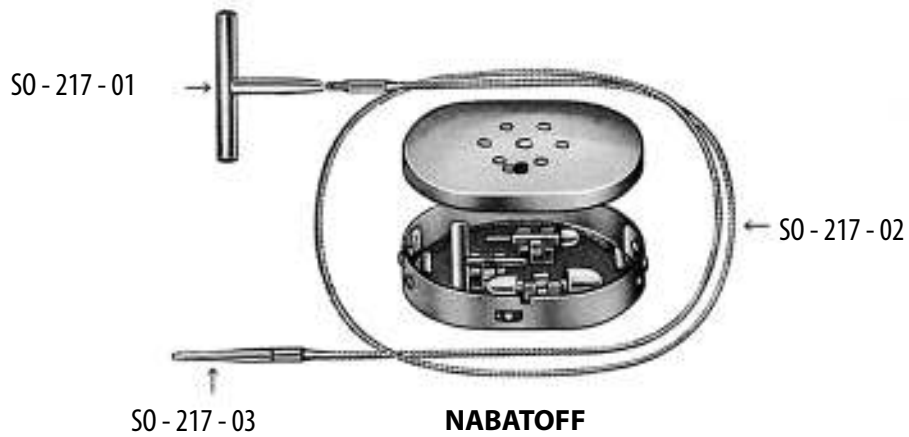

NABATOFF
SO - 218 - 09
complete



malleable

GARRETT



14,0 cm / 5 1/2"

21,0 cm / 8 1/2"

1,0 mm	SO - 210 - 10	SO - 211 - 10
1,5 mm	SO - 210 - 15	SO - 211 - 15
2,0 mm	SO - 210 - 20	SO - 211 - 20
2,5 mm	SO - 210 - 25	SO - 211 - 25
3,0 mm	SO - 210 - 30	SO - 211 - 30
3,5 mm	SO - 210 - 35	SO - 211 - 35
4,0 mm	SO - 210 - 40	SO - 211 - 40
4,5 mm	SO - 210 - 45	SO - 211 - 45
5,0 mm	SO - 210 - 50	SO - 211 - 50



malleable

COOLEY
13,0 cm / 5"

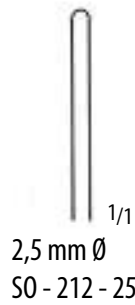

DE BAKEY
1/2

0,5 mm Ø ^{1/1} 1,0 mm Ø 1,5 mm Ø

2,0 mm Ø ^{1/1} 2,5 mm Ø 3,0 mm Ø

3,5 mm Ø ^{1/1} 4,0 mm Ø 4,5 mm Ø

5,0 mm Ø ^{1/1} 7,0 mm Ø 9,0 mm Ø

malleable

malleable

mm Ø	19,0 cm / 7 1/2"	35,0 cm / 14"
0,5	SO - 500 - 05	SO - 501 - 05
1,0	SO - 500 - 10	SO - 501 - 10
1,5	SO - 500 - 15	SO - 501 - 15
2,0	SO - 500 - 20	SO - 501 - 20
2,5	SO - 500 - 25	SO - 501 - 25
3,0	SO - 500 - 30	SO - 501 - 30
3,5	SO - 500 - 35	SO - 501 - 35
4,0	SO - 500 - 40	SO - 501 - 40
4,5	SO - 500 - 45	SO - 501 - 45
5,0	SO - 500 - 50	SO - 501 - 50
7,0	SO - 500 - 70	SO - 501 - 70
9,0	SO - 500 - 90	SO - 501 - 90

DE BAKEY
SO - 502 - 50
50 cm / 20"



50,0 cm / 20"

 1/1
2,0 mm
SO - 553 - 02



3,0 mm
SO - 553 - 03



4,0 mm
SO - 553 - 04

 1/1
6,0 mm
SO - 553 - 06

7,0 mm
SO - 553 - 07



8,5 mm
SO - 553 - 08

 1/1
10,0 mm
SO - 553 - 10

12,0 mm
SO - 553 - 12

14,0 mm
SO - 553 - 14



 1/2
SO - 554 - 12
12,0 cm / 4 3/4"

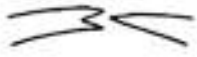

28,0 cm / 11 1/4"
38,0 cm / 15 1/4"
45,0 cm / 18"

S0 - 555 - 28
S0 - 555 - 38
S0 - 555 - 45

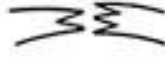

S0 - 556 - 28
S0 - 556 - 38
S0 - 556 - 45



S0 - 557 - 28
S0 - 557 - 38
S0 - 557 - 45

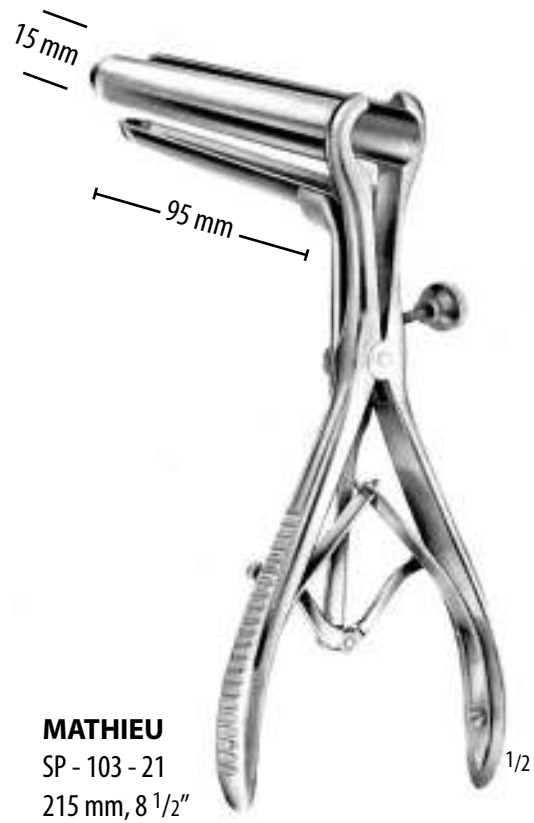
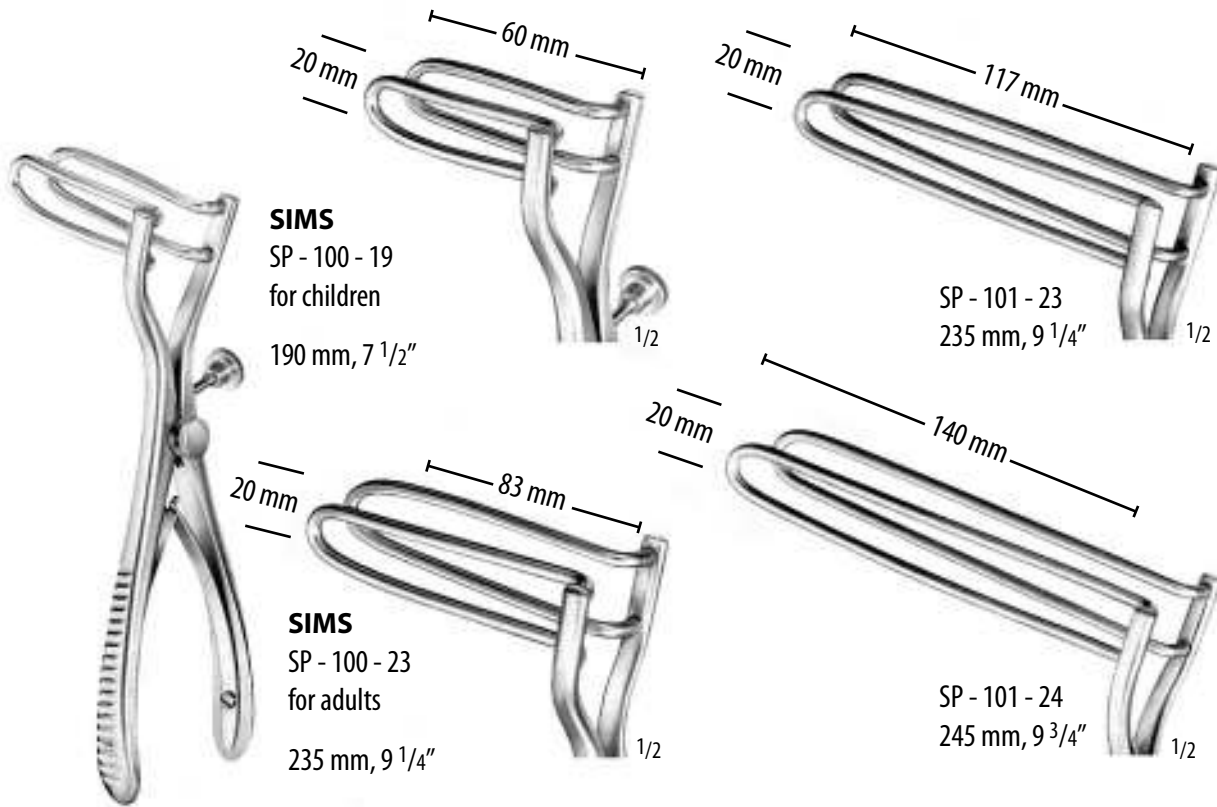

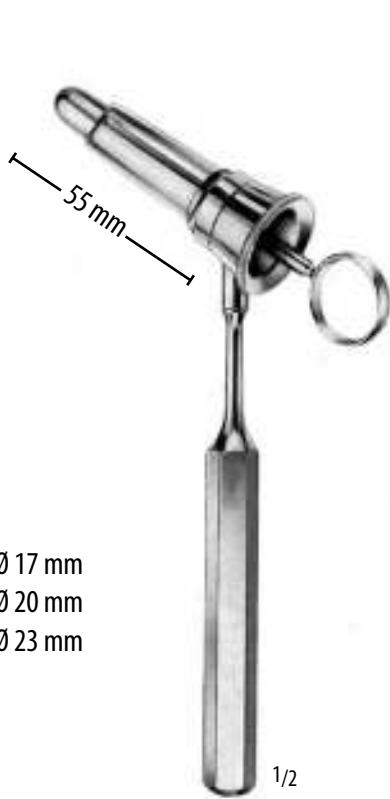

BENSAUDE

SP - 105 - 17 Ø 17 mm

SP - 105 - 20 Ø 20 mm

SP - 105 - 23 Ø 23 mm

Anuscopes

185 mm, 7 1/2"

1/2



IVES-FANSLER

SP - 106 - 14 Ø 24 mm

Anoscope

145 mm, 5 3/4"

1/2



KELLY

SP - 107 - 21 Ø 21 mm

Sphincteroscope

160 mm, 6 1/4"

1/2



KELLY

SP - 107 - 27 Ø 27 mm

Sphincteroscope

160 mm, 6 1/4"

1/2

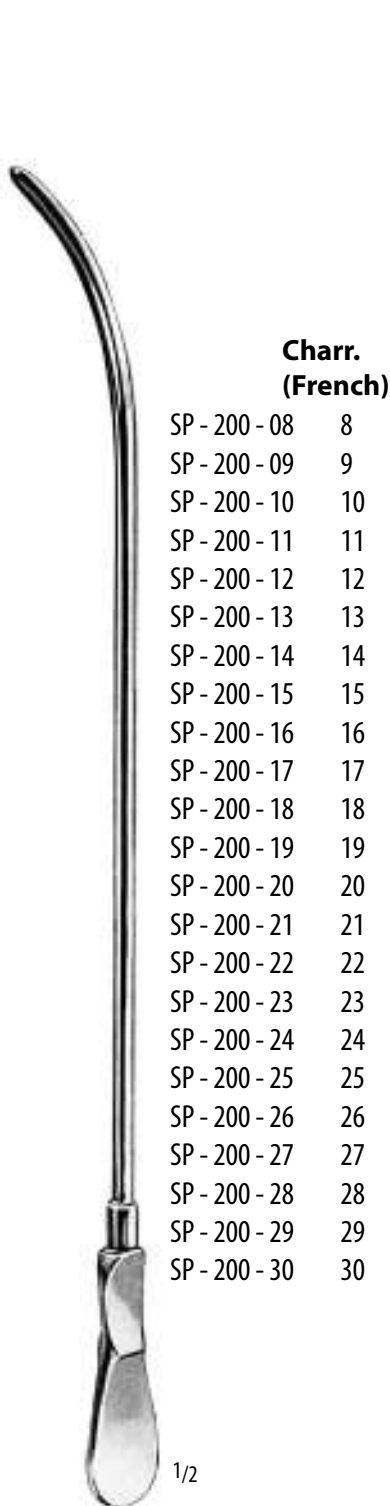

DITTEL
SP - 200 - 08 - SP - 200 - 30
Metal bougies and
dilating sounds, stiff

345 mm, 13 3/4"

	Charr. (French)
SP - 200 - 08	8
SP - 200 - 09	9
SP - 200 - 10	10
SP - 200 - 11	11
SP - 200 - 12	12
SP - 200 - 13	13
SP - 200 - 14	14
SP - 200 - 15	15
SP - 200 - 16	16
SP - 200 - 17	17
SP - 200 - 18	18
SP - 200 - 19	19
SP - 200 - 20	20
SP - 200 - 21	21
SP - 200 - 22	22
SP - 200 - 23	23
SP - 200 - 24	24
SP - 200 - 25	25
SP - 200 - 26	26
SP - 200 - 27	27
SP - 200 - 28	28
SP - 200 - 29	29
SP - 200 - 30	30

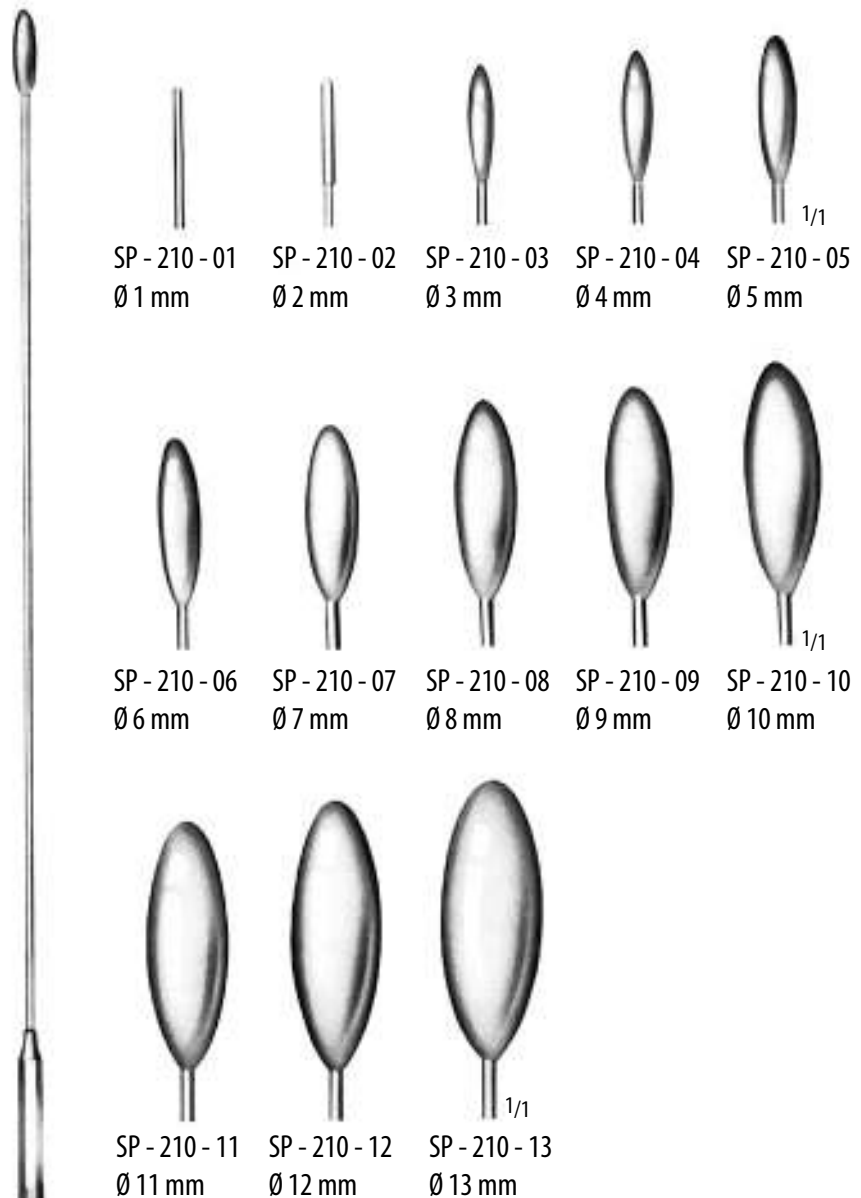

BAKES
SP - 210 - 01 - SP - 210 - 13
Common bile duct dilators,
malleable

SP - 210 - 01 - SP - 210 - 05 315 mm, 12 1/2"
SP - 210 - 06 - SP - 210 - 13 320 mm, 12 3/4"



COLLIN
SP - 250 - 00
53 X 10 mm
for children



COLLIN
SP - 250 - 01
95/85 X 18 mm
for virgins

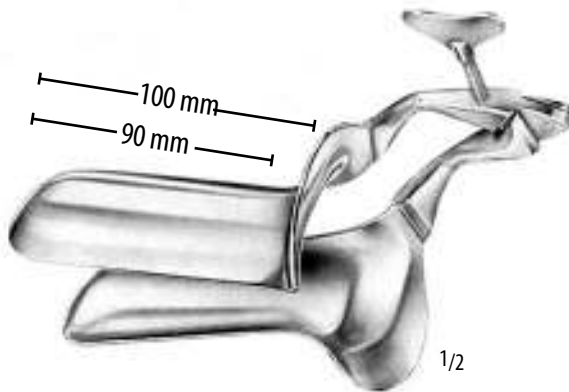

COLLIN
SP - 250 - 28 100/90 mm 28 mm
SP - 250 - 32 100/90 mm 32 mm
SP - 250 - 35 105/95 mm 35 mm
SP - 250 - 40 115/105 mm 40 mm
Total length/working length width



CUSCO
SP - 255 - 00
75 X 17 mm
for virgins



CUSCO
SP - 255 - 01
75 X 17 mm
for virgins



CUSCO
SP - 255 - 25 92 X 23 - 25 mm
SP - 255 - 27 100 X 25 - 27 mm
SP - 255 - 30 110 X 27 - 30 mm



CUSCO
SP - 256 - 01 80 X 32 mm
SP - 256 - 02 90 X 37 mm
SP - 256 - 03 115 X 37 mm



**CUSCO
STANDARD**

SP - 257 - 24	80 X 24 mm
SP - 257 - 32	80 X 32 mm
SP - 257 - 36	90 X 36 mm
SP - 257 - 37	110 X 37 mm



CUSCO

SP - 258 - 24	80 X 24 mm
SP - 258 - 32	80 X 32 mm
SP - 258 - 36	90 X 36 mm
SP - 258 - 37	110 X 37 mm



CUSCO

SP - 259 - 29	107 X 29 mm
SP - 259 - 35	115 X 35 mm



TRELAT

SP - 260 - 33	85 X 33 mm
SP - 260 - 35	95 X 35 mm
SP - 260 - 43	115 X 43 mm



GRAVE

- SP - 265 - 20 75 x 20 mm
- SP - 265 - 30 95 x 30 mm
- SP - 265 - 33 105 x 33 mm

1/2

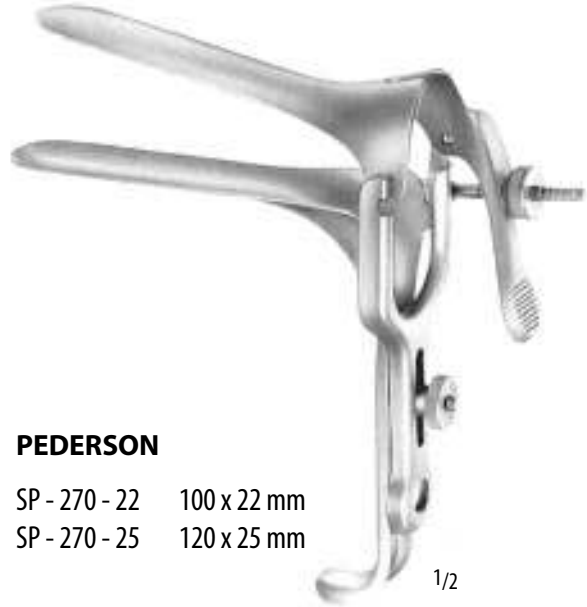

PEDERSON

- SP - 270 - 22 100 x 22 mm
- SP - 270 - 25 120 x 25 mm

1/2



1/2

- SP - 280 - 01 72 x 25 mm / 77 x 30 mm
140 mm, 5 1/2"
- SP - 280 - 02 75 x 30 mm / 92 x 38 mm
170 mm, 6 3/4"



1/2

SIMS

- SP - 285 - 01 70 x 26 mm / 75 x 30 mm
125 mm, 5"
- SP - 285 - 02 75 x 30 mm / 80 x 35 mm
150 mm, 6"
- SP - 285 - 03 80 x 36 mm / 90 x 40 mm
175 mm, 7"



HEGAR

With very conical point

SP - 500 - 01 - SP - 501 - 17

185 mm, 7 1/4"

SP - 500 - 01	1 mm	SP - 500 - 14	14 mm	SP - 501 - 01	1 1/2" mm	SP - 501 - 14	14 1/4" mm
SP - 500 - 02	2 mm	SP - 500 - 15	15 mm	SP - 501 - 02	2 1/2" mm	SP - 501 - 15	15 1/4" mm
SP - 500 - 03	3 mm	SP - 500 - 16	16 mm	SP - 501 - 03	3 1/2" mm	SP - 501 - 16	16 1/4" mm
SP - 500 - 04	4 mm	SP - 500 - 17	17 mm	SP - 501 - 04	4 1/2" mm	SP - 501 - 17	17 1/4" mm
SP - 500 - 05	5 mm	SP - 500 - 18	18 mm	SP - 501 - 05	5 1/2" mm		
SP - 500 - 06	6 mm	SP - 500 - 19	19 mm	SP - 501 - 06	6 1/2" mm		
SP - 500 - 07	7 mm	SP - 500 - 20	20 mm	SP - 501 - 07	7 1/2" mm		
SP - 500 - 08	8 mm	SP - 500 - 21	21 mm	SP - 501 - 08	8 1/2" mm		
SP - 500 - 09	9 mm	SP - 500 - 22	22 mm	SP - 501 - 09	9 1/2" mm		
SP - 500 - 10	10 mm	SP - 500 - 23	23 mm	SP - 501 - 10	10 1/2" mm		
SP - 500 - 11	11 mm	SP - 500 - 24	24 mm	SP - 501 - 11	11 1/2" mm		
SP - 500 - 12	12 mm	SP - 500 - 25	25 mm	SP - 501 - 12	12 1/2" mm		
SP - 500 - 13	13 mm	SP - 500 - 26	26 mm	SP - 501 - 13	13 1/2" mm		

HAWKIN-AMBLER

SP - 505 - 06 - SP - 505 - 17

175 mm, 7"



SP - 505 - 06	3 / 6 mm
SP - 505 - 07	4 / 7 mm
SP - 505 - 08	5 / 8 mm
SP - 505 - 09	6 / 9 mm
SP - 505 - 10	7 / 10 mm
SP - 505 - 11	8 / 11 mm
SP - 505 - 12	9 / 12 mm
SP - 505 - 13	10 / 13 mm
SP - 505 - 14	11 / 14 mm
SP - 505 - 15	12 / 15 mm
SP - 505 - 16	13 / 16 mm
SP - 505 - 17	14 / 17 mm

HEGAR

SP - 506 - 02 - SP - 506 - 18

205 mm, 8"



SP - 506 - 02	1 +2 mm
SP - 506 - 04	3+4 mm
SP - 506 - 06	5+6 mm
SP - 506 - 08	7+8 mm
SP - 506 - 10	9+10 mm
SP - 506 - 12	11+12 mm
SP - 506 - 14	13+14 mm
SP - 506 - 16	15+16 mm
SP - 506 - 18	17+18 mm

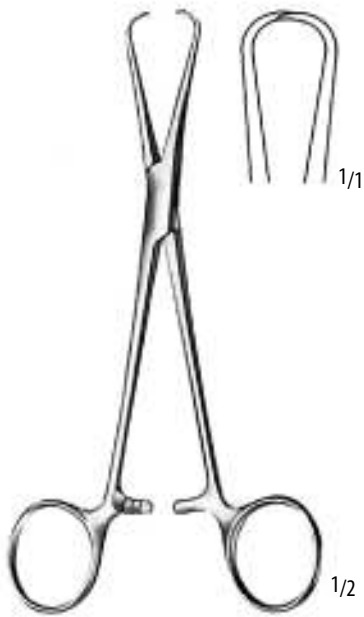

BERNHARD
TN - 100 - 16
160 mm, 6 1/4"

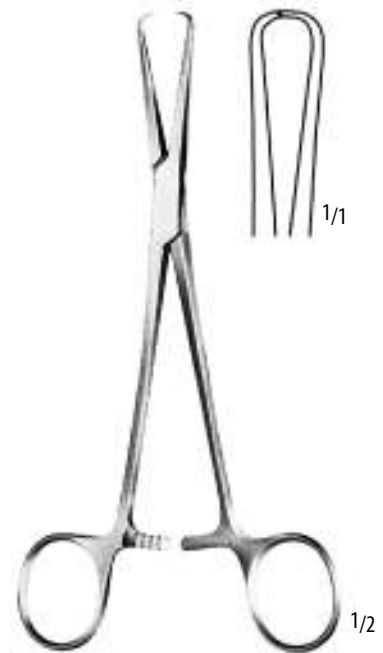

POZZI
TN - 100 - 17
175 mm, 7"



BRAUN
TN - 101 - 25
250 mm, 10"



COLLIN-POZZI
TN - 102 - 25
250 mm, 10"

STANDARD



SCHRÖDER
TN - 103 - 25
250 mm, 10"



SCHRÖDER
TN - 104 - 25
250 mm, 10"



WILSON
TN - 105 - 24
240 mm, 9¹/₂"



POZZI
TN - 106 - 25
Heavy pattern
255 mm, 10"



MARTIN
SP - 107 - 26
265 mm,
10¹/₂"



DUPLAY
SP - 108 - 25
250 mm, 10"

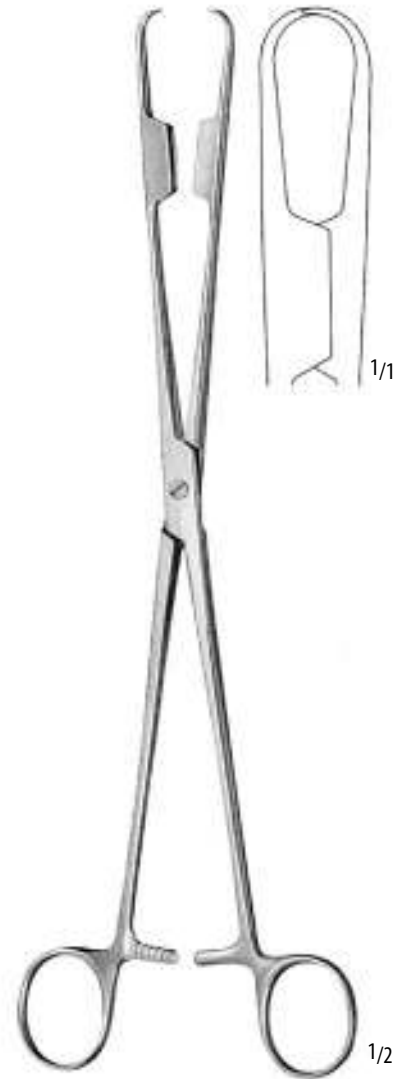

ABEL
SP - 109 - 28
280 mm, 11"

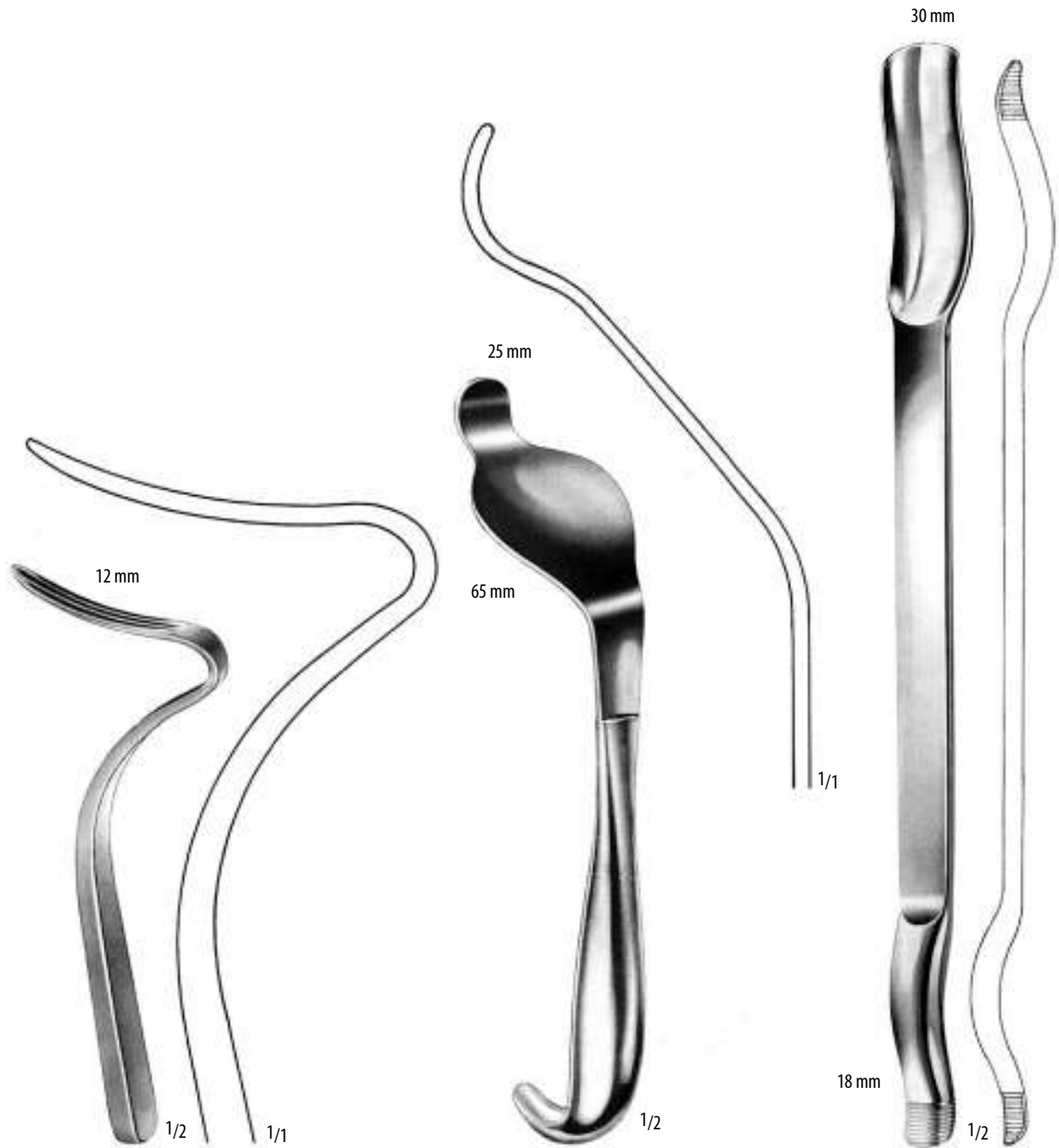

TÄGER

YC - 200 - 17

Bone lever for angle joint operations

175 mm, 7"

BENNETT

YC - 201 - 23

235 mm, 9¹/₂"

MURPHY-LANE

YC - 202 - 34

Luxation lever

340 mm, 13¹/₂"

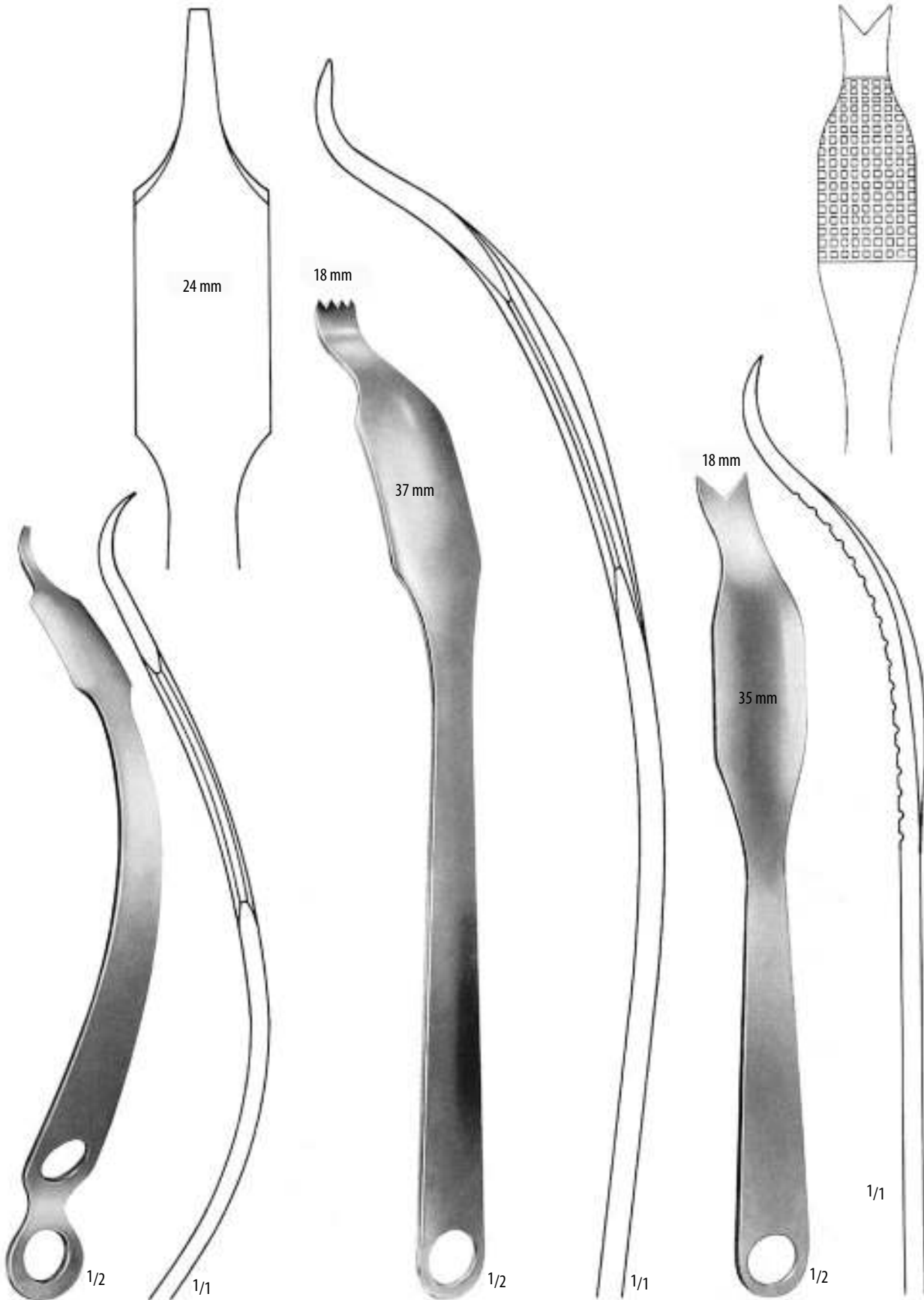

HOHMANN - ALDINGER
YC - 203 - 27
270 mm, 10³/₄"

SCHUMACHER mod. WAGNER
YC - 204 - 34
345 mm, 13¹/₂"

SCHUMACHER
YC - 205 - 29
290 mm, 11¹/₂"

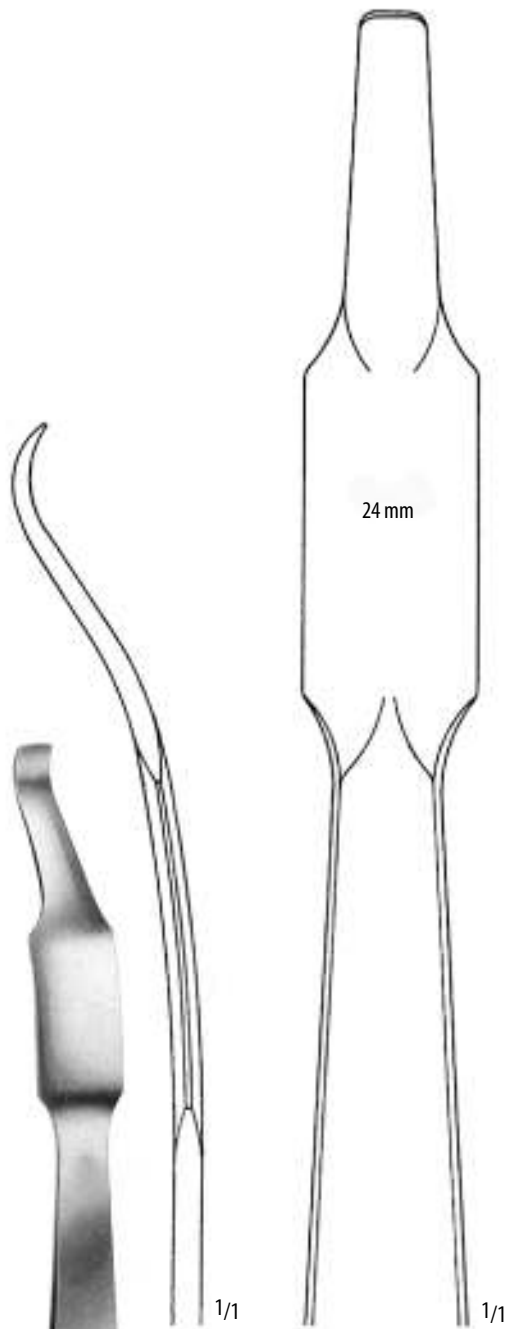

HOHMANN
YC - 206 - 26
260 mm, 10¹/₄"

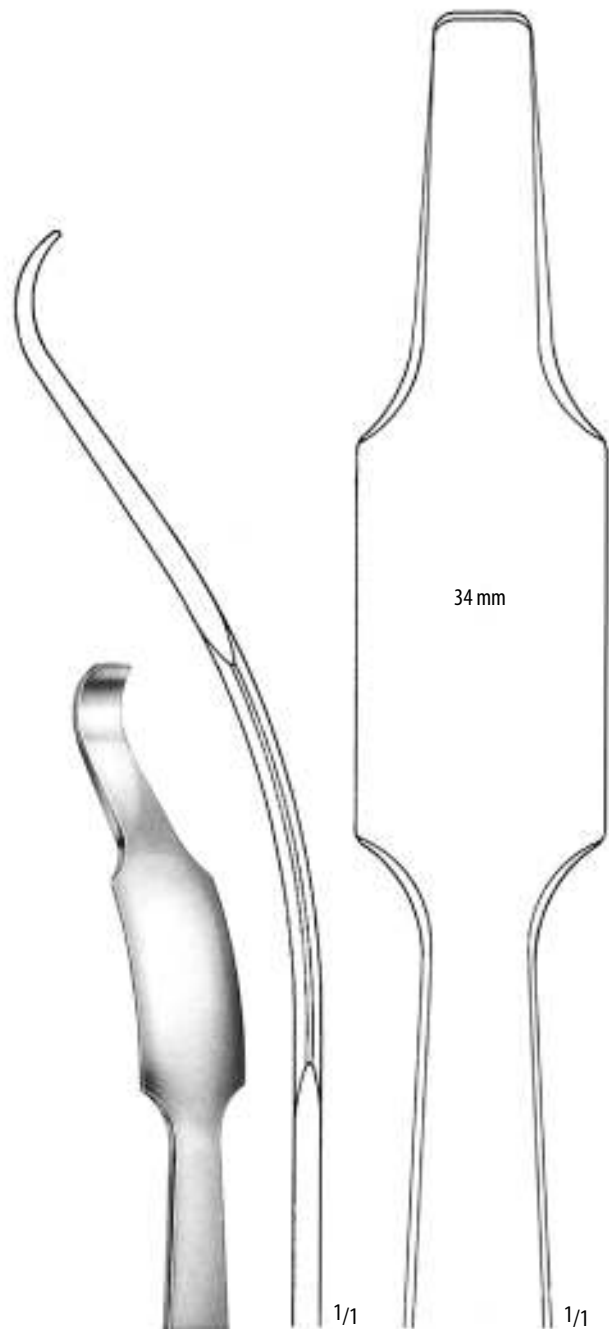

HOHMANN
YC - 207 - 28
285 mm, 11¹/₄"

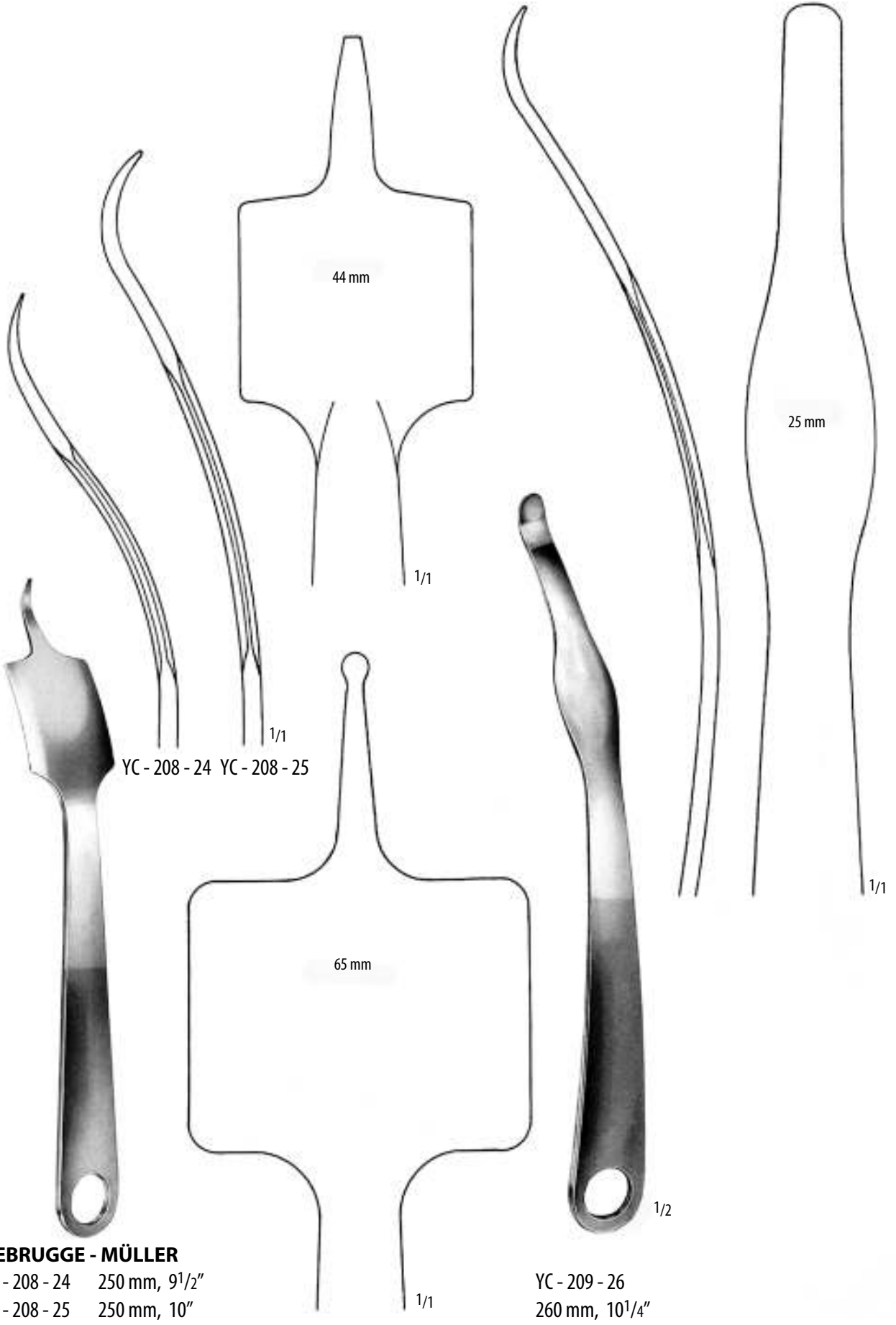

VEBRUGGE - MÜLLER

YC - 208 - 24 250 mm, 9 1/2"
YC - 208 - 25 250 mm, 10"

YC - 209 - 26
260 mm, 10 1/4"

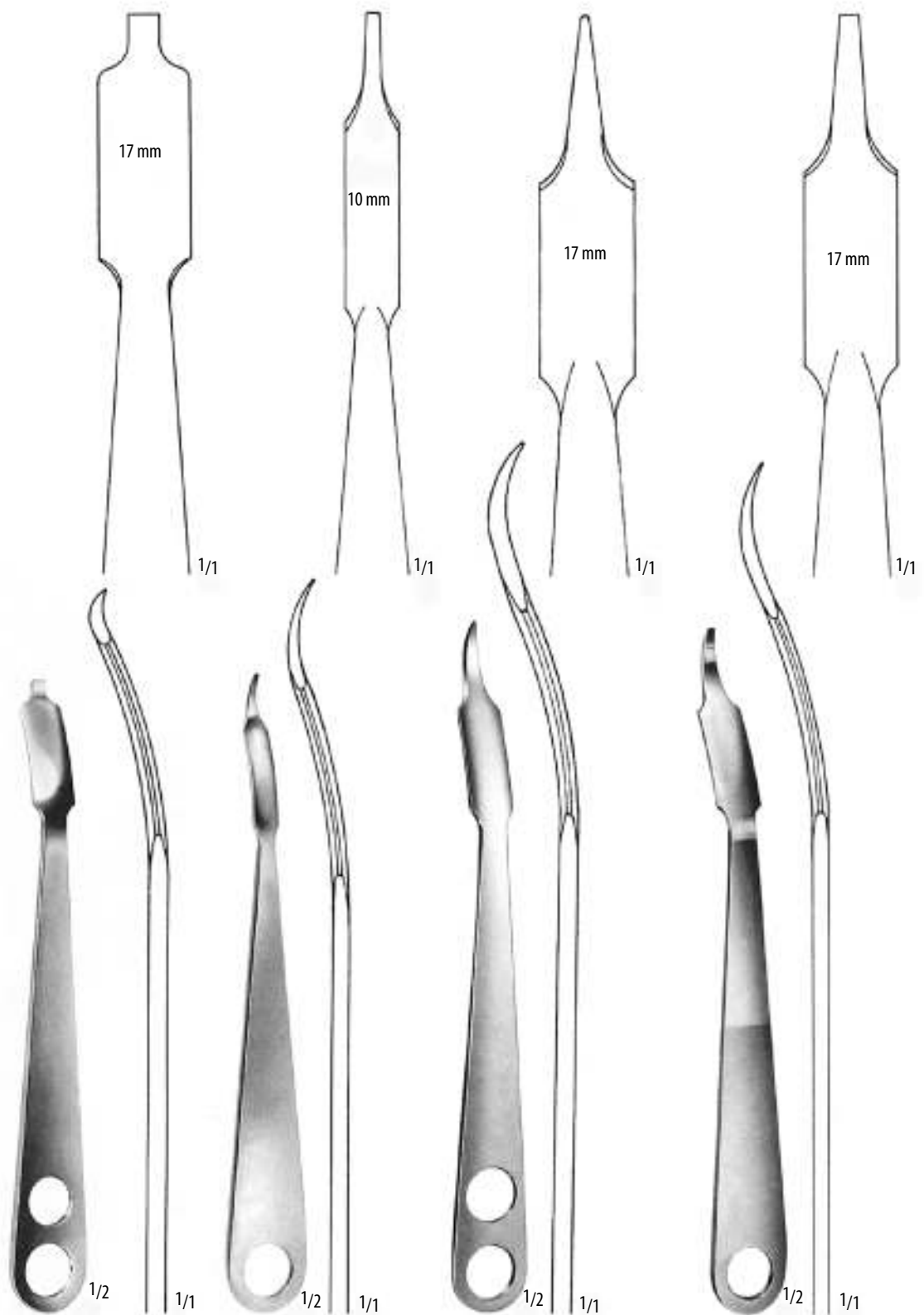

WAGNER
YC - 210 - 22
220 mm, 8³/₄"

YC - 211 - 22
220 mm, 8³/₄"

YC - 212 - 24
240 mm, 9¹/₂"

YC - 213 - 24
240 mm, 9¹/₂"

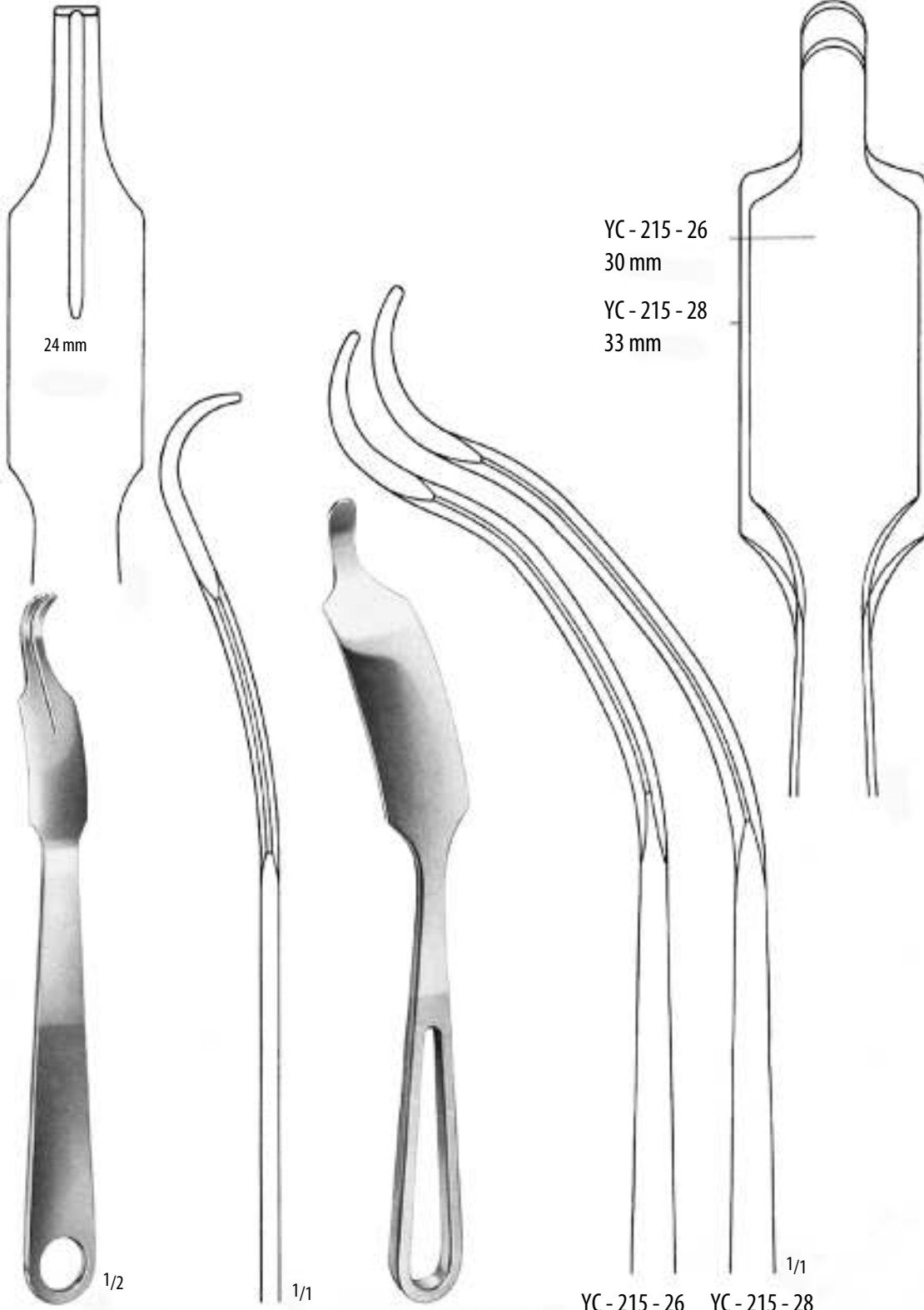

LANGE-HOHMANN

YC - 214 - 25
250 mm, 10"

LANGE-HOHMANN modif

YC - 215 - 26 265 mm, 10¹/₂"
YC - 215 - 28 280 mm, 11¹/₂"

INDEX

A

ABEL

Uterine Tenaculum Forceps.....367

ABRAHAM

Tonsil Forceps.....202

ADLERKREUTZ

Dressing - Tissue Forceps.....97

ADSON

Artery, Dissecting and Ligature Forceps.....147

Dissecting Forceps.....119

Dressing - Tissue Forceps.....91, 92

Galea Hooks, Handdrill.....345

Needle Holders.....300

Selfretaining Retractors.....67, 68

ADSON - BROWN

Dressing - Tissue Forceps.....92

AGNEW (POLITZER)

Scalpel Handles.....17

ALLIS

Tissue Seizing Forceps.....133

ALM

Selfretaining Retractors.....62

ANDERSON - ADSON

Selfretaining Retractors.....67

ARRUGA

Capsular Forceps.....113

Needle Holders.....297, 315, 327

AUSTIN

Micro - Suture Tying Forceps.....102

AYER

Muscular - Entropium - Chalazion Forceps.....116

B

BABCOCK

Tissue Seizing Forceps.....133

BABY - ADSON

Artery, Dissecting and Ligature Forceps.....147

BABY- CRILE- WOOD

Needle Holders.....299, 311

BABY - MIKULICZ

Peritoneal Clamp Forceps.....170

BABY - MIXTER	
Dissectign and Ligature Forceps.....	155
BABY - OVERHOLT	
Artery, Dissecting and Ligature Forceps.....	145
BABY - SENN - MILLER	
Delicate and Spiral Retractors.....	38
BACKHAUS	
Towel Forceps.....	173
BAINBRIDGE	
Tonsil Hemostatic, Artery Forceps.....	149
BAKES	
Gall Duct Dilators.....	356
BALFOUR	
Abdominal Retractors.....	76, 77
BALFOUR - BABY	
Abdominal Retractors.....	76
BALFOUR US - TYPE	
Abdominal Retractors.....	76
BALL & SOCKET	
Towel Forceps.....	173
BALLENGER	
Septum Goge.....	190
Swivel Knife.....	189
BARNHILL	
Adenoid Currettes.....	207
BARRAQUER	
Cilia Forceps.....	106
Iris Scissors.....	251
Needle Holders.....	321
Suture Forceps.....	115
BARRAQUER - KATZIN	
Iris Forceps.....	112
BARRAQUER-TROUTMAN	
Needle Holders.....	321
BEALE	
Hooks.....	128
BEALES	
Tendom Knife.....	129
BECKMANN	
Adenoid Currettes.....	206
Nasal Specula.....	181
Selfretaining Retractors.....	69
BECKMANN - ADSON	
Selfretaining Retractors.....	70
BECKMANN - EATON	
Selfretaining Retractors.....	70

BEEBEE	
Crown Scissors.....	244
Wire Cutting and Crown Scissors.....	243
BEER	
Cilia Forceps.....	106
BELLUCCI	
Micro Scissors.....	179
BENGOLEA	
Artery Forceps.....	150
BENNETT	
Bone Levers.....	369
BENSAUDE	
Anuscopes - Schincteroscopes.....	355
BERGMANN	
Bandage and Clothing Scissors.....	245
BERNHARD	
Towel Forceps.....	172
Uterine Tenaculum Forceps.....	363
BILLEAU	
Ear Loop.....	30
BILLROTH	
Retractors.....	40
BINKHORST	
Capsular Forceps.....	113
BIRKETT	
Dissecting and Ligature. Hysterectomy Forceps.....	163
BISHOP - HARMAN	
Iris Forceps.....	112
BLASCOVICS	
Muscular - Entropium - Chalazion Forceps.....	116
BLOHMKE	
Tonsil Forceps.....	202
BOETTCHER	
Tonsil Scissors.....	204
BONACCOLTO	
Suture Forceps.....	115
BONNEY	
Dissecting Forceps.....	120
Dressing - Tissue Forceps.....	99
BOSE	
Tracheal Dilators.....	212
BÖTTCHER	
Tonsil and Nasal, Goitre Enucleation Scissors.....	232
BOYNTON	
Needle Holders.....	297, 315
BOZEMANN	
Needle Holders.....	299, 320

Sponge Holding Forceps.....	22
Suture Instruments.....	338
BOZEMANN - DOUGLES	
Sponge Holding Forceps.....	22
BRAUN	
Uterine Tenaculum Forceps.....	364
BRAUN - STADLER	
Episiotomy and Umbilical Scissors.....	234
BRIDGE	
Dissectign and Ligature Forceps.....	156
BRODIE	
Probes.....	348
BROPHY	
Dressing - Tissue Forceps.....	95
BROPHY (SULLIVAN)	
Fine Scissors.....	236
BROWN	
Dressing - Tissue Forceps.....	96
Grasping Forceps 98	
Needle Holders.....	300
BRUNINGS	
Elevator - Raspatory.....	185
Tonsil Snares.....	205
BRUNNER	
Retractors.....	46
Rib Shears.....	278
Suture Instruments.....	331, 332, 335
BRUNNER-FERROZELL	
Suture Instruments.....	337
BRUNS	
Bandage, Plaster Scissors.....	247
Bone Curettes.....	274
BUCK	
Ear Currets.....	32
Ear Forceps.....	32
Ligature Scissors.....	242
BUMM	
Plasenta - and Ovum Curettes.....	273
BUNNEL	
Hand Drills, Twist Drills.....	295
BUSCH	
Episiotomy and Umbilical Scissors.....	234
BUSHE	
Bone Curettes.....	275

C

CAPLAN

Tonsil and Nasal, Goitre Enucleation Scissors.....232

CARDINALE

Gynecological Scissors.....220

Scissors.....264

CARREL

Artery Forceps.....138

CARROLL

Needle Holders.....299, 309

CASPAR

Bone Curettes.....276

Rongeurs.....341, 342

CASTROVIEJO

Capsular Forceps.....113

Fixation Forceps.....114

Iris Scissors.....251

Needle Holders.....318, 319, 325, 328

Suture Forceps.....115

Tenotomy, Corneal Scissors.....253

CASTROVIEJO-KALT

Needle Holders.....327

CATLIN

Scalpels.....12

CAWTHORNE

Ear Hooks.....31

CHADWICK

Eye Scissors.....239

CHAPUT

Seizing Forceps, Blood Vessel Clamp, Scalp Flap Forceps.....136

CHERON

Sponge Holding Forceps.....23

CHILDE

Clip Applying.....340

CHURCH

Scissors For Vascular and Neuro Surgery.....230

CINELLI

Osteotomes.....196

CLASSON

Scissors For Vascular and Neuro Surgery.....230

CLAUS

Suture Instruments.....333

CLAUS-EICKEN

Suture Instruments.....334

COLLER

Artery Forceps.....141

COLLIER	
Needle Holders.....	297
COLLIN	
Abdominal Retractors.....	81, 82
Artery Forceps.....	137
Clip Applying.....	339
Scalpel Handles.....	8
Scalpels.....	10, 12
Sponge Holding Forceps.....	23
Vaginal Specula.....	357
COLLIN - BABY	
Abdominal Retractors.....	81
COLLIN-POZZI	
Uterine Tenaculum Forceps.....	364
CONE	
Selfretaining Retractors.....	69
CONVERSE	
Alar Retractor.....	194
Needle Holders.....	310
COOLEY	
Probes.....	350
COOPER	
Suture Instruments.....	331
CORWIN	
Needle Holders.....	317
CORYLLOS	
Retractors.....	57, 59
COTTLE	
Alar Retractor.....	194
Elevator - Raspatory.....	192
Mallet.....	197
Nasal Scissors.....	233
Nasal Specula.....	182
Osteotomes.....	195
CRAFOORD	
Artery, Bronchus Forceps.....	152
Cartilage - Lobectomy - Enterotomy - Dissecting Scissors.....	231
CRAFOORD - SELLORS	
Auricle, Dissecting and Ligature Forceps.....	151
CRANE - KAPLAN	
Pocket Markers, Articulating Paper Forceps.....	124
CRILE	
Artery Forceps.....	141
Needle Holders.....	304
CRILE - RANKIN	
Artery Forceps.....	141

CRILE-WOOD	
Needle Holders.....	299, 311
CUSCO	
Vaginal Specula.....	358, 359
CUSCO STANDARD	
Vaginal Specula.....	359
CUSHING	
Delicate and Spiral Retractors.....	38
Delicate Hooks.....	36, 126
Dissecting Forceps.....	119
Dressing - Tissue Forceps.....	94
Galea Hooks, Handdrill.....	345
Rongeurs.....	343
CUSHING - TAYLOR	
Dissecting Forceps.....	119
D	
DANDY	
Artery, Scalp Flap Forceps.....	148
Scissors For Vascular and Neuro Surgery.....	228
DARLING	
Selfretaining Retractors.....	72
DAUBENSPECK	
Bone Curettes.....	275
DAVIDSON	
Retractors.....	59
DAVIS - BOYLE	
Tongue Depressors.....	200
DAVIS - MEYER	
Tongue Depressors.....	200
DEAN	
Gum Scissors.....	249
Tonsil Scissors.....	204
DEAVER	
Operating Scissors.....	217
Retractors.....	52, 53, 54
DE BAKEY	
Dissecting Forceps.....	120
Non - Traumatic Vascular Tissue Forceps.....	117
Scalpel Probes.....	351
Scissors.....	266
Scissors For Vascular and Neuro Surgery.....	229
Scissors For Vascular Surgery.....	226
DE BAKEY(MAYO-HEGAR)	
Needle Holders.....	307

DE LA ROZA	
Suture Instruments.....	332
Delicate Hooks.....	33
DERF	
Needle Holders.....	297, 310
DERF- CONVERSE	
Needle Holders.....	297
DESCHAMPS	
Suture Instruments.....	330
DESJARDINS	
Gall Duct Forceps.....	162
DESMARRES	
Delicate Hooks.....	36
Muscular - Entropium - Chalazion Forceps.....	116
DIEFFENBACH	
Bulldog Clamps.....	135
Scalpels.....	10, 11, 14
DIETRICH	
Needle Holders.....	319
DITTEL	
Gall Duct Dilators.....	356
DIXON - LOVELACE	
Artery, Scalp Flap Forceps.....	148
DOUGLAS	
Cilia Forceps.....	106
DOYEN	
Abdominal Retractors.....	79
Gynecological and Abdominal Scissors.....	219
Needle Holders.....	297
Probes.....	347
Retractors.....	50
Towel Forceps.....	172
DOYEN - STILLE	
Retractors.....	49
DUBOIS	
Gynecological Scissors.....	220
DUEHRSEN	
Dressing - Tissue Forceps.....	96
DUPLAY	
Sponge Holding Forceps.....	25
Uterine Tenaculum Forceps.....	367
DURANTE	
Dressing - Tissue Forceps.....	99
DUVAL	
Dressing - Tissue Forceps.....	99

E

ECHLIN

Bone Rongeurs.....284

EISELSBERG

Ligature Scissors.....241

EISELSBERG-MATHIEU

Needle Holders.....304, 316

ELSCHING

Fixation Forceps.....114

ENGL. MODELL

Towel Forceps.....172

ERHARDT

Muscular - Entropium - Chalazion Forceps.....116

ESMARCH

Bandage, Plaster Scissors.....247

EUFRATE PASQUÉ

Needle Holders.....308

EVES

Tonsil Snares.....205

EWALD

Dressing - Tissue Forceps.....92

F

FALK

Suture Instruments.....334

FARABEUF

Retractors.....60

FARRELL

Probes.....348

FAURE

Hysterectomy Forceps.....167

Peritoneal Clamp Forceps.....171

FAVALORO

Scissors For Vascular and Neuro Surgery.....228

FEILCHENFELD

Splinter Forceps.....104

FEIN

Probes.....349

FERGUSSON

Angiotribes, Haemorrhoidal Forceps.....169

Operating Scissors.....217

FERRIS - SMITH

Dressing - Tissue Forceps.....97

FERROZELL	
Suture Instruments.....	337
FINOCCHIETTO	
Gall Duct and Kidney Pedicle Clamp Forceps.....	159
Needle Holders.....	302, 320
FINOCHIETTO	
Cartilage - Lobectomy - Enterotomy - Dissecting Scissors.....	231
FINSEN	
Selfretaining Retractors.....	62
FISCHER - ARLT	
Iris Forceps.....	110
FLAGG	
Cotton and Dressing Pliers.....	122
FLETCHER	
Sponge Holding Forceps.....	21
FOERSTER	
Iris Forceps.....	111
FOERSTER - BALLENGER	
Sponge Holding Forceps.....	26
FOMON	
Alar Retractor.....	194
Dissecting Scissors.....	224
Osteotomes.....	196
Rasps.....	197
Tonsil and Nasal, Goitre Enucleation Scissors.....	232
FRANCIS ALAE - NASI	
Nasal Dilators.....	189
FRANZ	
Abdominal Retractors.....	79
FRAZIER	
Delicate Hooks.....	125
Suction Cannulas.....	5
FREER	
Elevator.....	186
Elevator - Raspatory.....	185, 187, 192, 193
Septum Chisel.....	188
Septum Gouge.....	190
FREER - YASARGIL	
Dissector.....	186
Elevator - Raspatory.....	193
FRIEDRICH	
Suture Instruments.....	338
FRITSCH	
Retractors.....	49
FRYKHOLM	
Bone Rongeurs.....	284

FULTON	
Scissors For Vascular and Neuro Surgery.....	230
G	
GARLAND	
Hysterectomy Forceps.....	166
GARRETT	
Probes.....	350
GELPI	
Selfretaining Retractors.....	71
GEMINI	
Dissectign and Ligature Forceps	157
GERALD	
Dressing - Tissue Forceps.....	94
GERSTER	
Bone Clamps.....	283
GIERTZ-STILLE	
Rib Shears.....	278
GIL - VERNET	
Delicate Hooks.....	37
GILL - FUCHS	
Capsular Forceps.....	113
GILL - HESS	
Iris Forceps.....	112
GILLIES	
Delicate Hooks.....	125
Dissecting Forceps.....	118
Dressing - Tissue Forceps.....	99
Needle Holders.....	302, 312
Osteotomes.....	196
GOELET	
Retractors.....	61
GOLDMAN - FOX	
Gum Scissors.....	249
Scissors.....	270
GOLDMAN - FOX (SPEZIAL)	
Gum Scissors.....	249
GOOD	
Tonsil and Nasal, Goitre Enucleation Scissors.....	232
Tonsil Scissors.....	204
GOOD - SCHWECKENDICK	
Tonsil and Nasal, Goitre Enucleation Scissors.....	232
GOSSET	
Abdominal Retractors.....	75

GRADLE	
Cilia Forceps.....	106
GRAEFE	
Delicate Hooks.....	125
Fixation Forceps.....	114
Tris Forceps.....	109
GRAVE	
Vaginal Specula.....	360
GRAY	
Gall Duct Forceps.....	162
GRAZIL	
Operating Scissors.....	216
GROSS - MAIER	
Sponge Holding Forceps.....	20
GRUENWALD	
Dressing - tampon - Cover Glass Forceps.....	108
GRUENWALD (JANSEN)	
Dressing - tampon - Cover Glass Forceps.....	108
GUTHRIE	
Delicate Hooks.....	34
GUYON	
Kidney Pedicle Clamp Forceps.....	160, 161
GWYNNE EVANS	
Tonsil Dissector.....	203
H	
HABERER	
Abdominal Retractors.....	85
HALLE	
Bone Curettes.....	275
Elevator - Raspatory.....	185, 192
Nasal Scissors.....	233
HALSEY	
Needle Holders.....	298, 310
HALSTED	
Artery Forceps.....	140
HALSTED - MOSQUITO	
Fine Artery Forceps.....	139
HARRINGTON	
Retractors.....	50
HARTMANN	
Artery Forceps.....	138
Ear Forceps.....	175, 176
Nasal Specula.....	181
Tongue Depressors.....	199

Tuning Forks.....	29
HARTMANN - HALLE	
Nasal Specula.....	180
HARVEY	
Wine Cutting Pliers, Lateral Cutting Action.....	293
Wire Cutting and Crown Scissors.....	243
HASSBERG	
Suture Instruments.....	332
HAWKIN-AMBLER	
Uterine Dilators.....	361
HEANEY	
Hysterectomy Forceps.....	165
Needle Holders.....	301
Retractors.....	60
HEANEY - BALLANTINE	
Hysterectomy Forceps.....	165
HEANEY - KANTER	
Hysterectomy Forceps.....	165
HEANEY - REZAK	
Hysterectomy Forceps.....	166
HEATH	
Ligature Scissors.....	242
HEGAR	
Uterine Dilators.....	361
HEGEMANN - DIETRICH	
Scissors For Vascular Surgery.....	227
HEGENBARTH	
Clip Applying.....	339
HEIFETZ	
Grasping Forceps.....	101
HEISS	
Artery, Bronchus Forceps.....	152
HENCKEL	
Ear Forceps.....	176
HENKE	
Tonsil Dissector.....	203
HENLEY	
Selfretaining Retractors.....	65
HENNIG	
Plaster Spreader, Plaster Breakers.....	289
HERRICK	
Kidney Pedicle Clamp Forceps.....	161
HESS	
Iris Forceps.....	111
HEYMANN	
Nasal Scissors.....	184, 233

HEYWOOD - SMITH	
Sponge Holding Forceps.....	25
HILL	
Elevator.....	186
HOESEL	
Retractors.....	48
HOHMANN	
Bone Levers.....	371
HOHMANN - ALDINGER	
Bone Levers.....	370
HÖSEL	
Needle Holders.....	305, 315
HOUGH	
Footplate Hook.....	128
HOUSE	
Curettes.....	132
HOWARTH	
Elevator - Raspatory.....	187, 193
HUDSON	
Galea Hooks, Handdrill.....	345
HUNT	
Grasping Forceps.....	101
HUNTER	
Splinter Forceps.....	104
HURD	
Suture Instruments.....	333
Tonsil Dissector.....	203
I	
ISRAEL	
Retractors.....	41
IVES-FANSLER	
Anusscopes - Schincteroscopes.....	355
J	
JACKSON	
Dressing - tampon - Cover Glass Forceps.....	108
JACOBI	
Suture Instruments.....	332
JACOBSON	
Needle Holders.....	299, 309, 319, 325
JAMESON	
Needle Holders.....	301

JANSEN	
Ear and Nose Dressing Forceps.....	107
Selfretaining Retractors.....	63
JANSEN - MIDDLETON	
Nasal Forceps.....	189
JATHO	
Biopsy Forceps.....	208
Nasopharynx Forceps.....	208
JEWELER	
Dissecting Forceps.....	118
JOBSON-HORNE	
Probes.....	349
JOHNS - HOPKINS	
Bulldog Clamps.....	135
JOHNS HOPKINS	
Dissectign and Ligature Forceps.....	154
JONES	
Towel Forceps.....	172
JOSEPH	
Delicate Hooks.....	34
Dissecting Scissors.....	225
Rasps.....	197
K	
KADER	
Retractors.....	56
KALT	
Needle Holders.....	319, 327
KALT-ARRUGA	
Needle Holders.....	327
KANTROWITZ	
Dissectign and Ligature Forceps.....	157
KATZIN	
Corneal Section Scissors.....	254
KATZIN - BARRAQUER	
Corneal Section Scissors.....	254
KELLY	
Anuscopes - Schincteroscopes.....	355
Artery Forceps.....	141
Gynecological and Abdominal Scissors.....	219
Retractors.....	51
Sponge Holding Forceps.....	24
KELLY - RANKIN	
Artery Forceps.....	141

KILLIAN	
Elevator.....	186
Elevator - Raspatory.....	187, 193
Nasal Specula.....	182
KILLIAN - CLAUS	
Septum Goge.....	190
KILNER	
Alar Retractor.....	194
Delicate Hooks.....	125
Needle Holders.....	298, 310
KILNER (RAGNELL)	
Dissecting Scissors.....	225
KIRBY	
Iris Forceps.....	112
KIRSCHNER	
Abdominal Retractors.....	80
Suture Instruments.....	337
KIRSCHNER-FERROZELL	
Suture Instruments.....	337
KIRSTEIN	
Nasal Scissors.....	184
KLEINERT - KUTZ	
Delicate Hooks.....	125
KLINIKUM BERLIN	
Tubing Clamps.....	174
KLINKENBERGH - LOTH	
Scissors For Vascular and Neuro Surgery.....	230
KNAPP	
Delicate Hooks.....	34
KNIGHTON	
Selfretaining Retractors.....	74
KNOWLES	
Bandage and Clothing Scissors.....	246
KOCHER	
Delicate Artery Forceps.....	144
Retractors.....	39, 44, 49
Suture Instruments.....	331, 337
KOCHER - LANGENBECK	
Retractors.....	43
KOERTE	
Retractors.....	40, 54
KÖNIG	
Nail, Cuticle, Nail, Splitting Scissors.....	248
Suture Instruments.....	336
KRAUSE	
Nasal Polypus.....	183

KRAUSE - VOSS	
Nasal Polypus.....	183
KROENLEIN	
Artery Forceps.....	137
KRONECKER	
Suture Instruments.....	333
KUEHNE	
Dressing - tampon - Cover Glass Forceps.....	108
L	
LABORDE	
Tracheal Dilators.....	212
LACK	
Tongue Depressors.....	199
LAFORCE	
Adenotomes.....	208
LA GRANGE	
Eye Scissors.....	239
LAHEY	
Gall Duct and Kidney Pedicle Clamp Forceps.....	159
Retractors.....	46
LAMBOTTE	
Bone Holding Forceps.....	282
Chisels and Gouges, Osteotomes.....	214
Osteotomes.....	196
LANDGRAF	
Cotton and Dressing Pliers, Suture Tweezers.....	123
LANDOLT	
Fine Scissors	237
LANE	
Dressing - Tissue Forceps.....	93
Towel Forceps.....	172
LANGE	
Bandage and Clothing Scissors.....	245
Clip Applying.....	340
LANGE-HOHMANN	
Bone Levers.....	374
LANGE-HOHMANN modif	
Bone Levers.....	374
LANGENBECK	
Ear Loop.....	30
Needle Holders.....	316
Retractors	42
Scalpels.....	12

LANGENBECK-RYDER	
Needle Holders.....	316
LAWRENCE	
Dissectign and Ligature Forceps.....	156
LEGUEU	
Blader Retractors.....	87
LEKSELL - STILLE	
Bone Rongeurs.....	285
LEMPERT	
Bone Curettes.....	275
LERICHE	
Artery Forceps.....	140
LESTER	
Fixation Forceps.....	114
LEXER	
Scissors.....	267
LEXER - BABY	
Dissecting Scissors.....	224
LICHTENBERG	
Needle Holders.....	304, 315
LINCOLN	
Scissors For Vascular and Neuro Surgery.....	230
LISTER	
Bandage, Plaster Scissors.....	247
Bandage and Clothing Scissors.....	246
Scissors.....	270
Sponge Holding Forceps.....	19
LISTER - EXCENTRIC	
Bandage and Clothing Scissors.....	246
LISTON	
Bone Cutting Forceps.....	286, 287
Scalpels.....	12
LISTON-KEY-HORSLEY (TUDOR EDWARDS)	
Bone Cutting Forceps.....	288
Rib Holding Forceps, Bone Cutting Forceps	279
LISTON - STILLE	
Bone Cutting Forceps.....	288
Rib Holding Forceps, Bone Cutting Forceps.....	279
LITTAUER	
Cilia Forceps.....	106
Ligature Scissors.....	241
LITTLE	
Retractors.....	46
LITTLER	
Fine Scissors.....	236
LOCKHART-MUMMERY	
Probes.....	348

LOCKLIN	
Gum Scissors.....	249
LONDON COLLEGE	
Cotton and Dressing Pliers.....	121
LONG	
Hysterectomy Forceps.....	166
LOPEZ - REINKE	
Tonsil Dissector	203
LORENZ	
Bandage and Clothing Scissors	246
LORNA	
Towel Forceps.....	173
LOVE-GRUENWALD	
Rongeurs.....	343
LOWER	
Gall Duct and Kidney Pedicle Clamp Forceps.....	159
LOWMAN	
Bone Clamps.....	283
LOWMAN - GERSTER	
Bone Clamps.....	283
LOWMAN - HOGLUND	
Bone Clamps.....	283
LUCAE	
Ear and Nose Dressing Forceps.....	107
Ear Hooks.....	31
Scalpel Handles.....	17
Tuning Forks.....	29
LUETHY-BECK	
Needle Holders.....	316
M	
MACDONALD	
Dissector	186
MALTZ	
Rasps.....	197
MARBACH	
Episiotomy and Umbilical Scissors.....	234
MARKHAM - MEYERDING	
Selfretaining Retractors.....	71
MARKWALDER	
Rib Rongeurs.....	280
MARSCHIK - KRONE	
Tonsil Forceps.....	202
MARTEL	
Seizing Forceps, Blood Vessel Clamp, Scalp Flap Forceps.....	136

MARTIN	
Retractors.....	45
Uterine Tenaculum Forceps.....	367
MARTIN - CARTILAGE	
Cartilage - Lobectomy - Enterotomy - Dissecting Scissors.....	231
MASING	
Osteotomes.....	195
MASSON	
Needle Holders.....	301, 320
MATHIEU	
Needle Holders.....	303, 313
Rectal Specula.....	354
Retractors.....	61
MATHIEU-RYDER	
Needle Holders.....	314
MAYO	
Operating and Gynecological Scissors.....	218
Scissors.....	262
MAYO - ADAMS	
Selfretaining Retractors.....	73
MAYO-HEGAR	
Needle Holders.....	301, 307
MAYO - NOBLE	
Operating and Gynecological Scissors.....	218
MAYO - RUSS.	
Grasping Forceps.....	98
MAYO - STILLE	
Operating and Gynecological Scissors.....	218
Scissors.....	263
MC INDOE	
Cartilage - Lobectomy - Enterotomy - Dissecting Scissors.....	231
McINDOE	
Dressing - Tissue Forceps.....	92
MC KENZIE	
Galea Hooks, Handdrill.....	345
MEEKER	
Artery, Dissecting and Ligature Forceps.....	147
MERIAM	
Cotton and Dressing Pliers.....	122
METZENBAUM	
Dissecting Scissors.....	221, 223
Needle Holders.....	313
Scissors.....	264, 265, 267, 268, 269
METZENBAUM - BABY	
Dissecting Scissors.....	221
METZENBAUM - NELSON	
Dissecting Scissors.....	222

MEYERDING	
Delicate Hooks.....	35
Retractors.....	56
MEYERDING	
Selfretaining Retractors.....	71
MICHEL	
Clip Applying.....	339
MICRO - ADSON	
Dressing - Tissue Forceps.....	91
MICRO - MOSQUITO	
Fine Artery Forceps.....	139
MICRO RYDER	
Needle Holders.....	308
MICROVASCULAR	
Needle Holders.....	308
MIDDELDORPF	
Retractors.....	47
MIKULICZ	
Retractors.....	51
MILLER	
Pocket Markers, Articulating Paper Forceps.....	124
Rasps.....	198
MILLIGAN	
Selfretaining Retractors.....	65
MILLIN	
Blader Retractors.....	87
MILLS	
Scissors For Vascular and Neuro Surgery.....	229
MINI - LANGENBECK	
Delicate Hooks.....	35
MIXTER	
Dissectign and Ligature Forceps.....	155, 156
Operating Scissors.....	217
MIXTER - O'SHAUGNESSY	
Dissectign and Ligature Forceps.....	155
MOD. BONN	
Fine Scissors.....	237
Iris Forceps.....	111
MOD. TÜBINGEN	
Suture Forceps.....	115
MOD. USA	
Episiotomy and Umbilical Scissors.....	234
Plaster Spreader, Plaster Breakers.....	289
MOD. WIEN	
Suture Instruments.....	338
MODELL TÜBINGEN	
Retractors.....	45

MODELL USA	
Dressing - Tissue Forceps.....	91
MOLDESTAD	
Delicate Hooks.....	126
MOLLINSON	
Tonsil Dissector.....	203
MOLLISON	
Selfretaining Retractors.....	66
MOORFIELD	
Fixation Forceps.....	114
MOYNIHAN	
Hysterectomy Forceps.....	166
MURPHY-LANE	
Bone Levers.....	369
MUSGROVE	
Ear Loop.....	30
MYRTLE LEAF	
Probes.....	347
N	
NABATOFF	
Probes.....	349
NAGER	
Suture Instruments.....	334
NEGUS	
Gall Duct Forceps.....	162
Suction Dissector.....	187
NEIVERT	
Needle Holders.....	298, 310
NÉLATON	
Probes.....	347
NELSON	
Grasping Forceps.....	98
NEUMANN	
Gum Scissors.....	250
NEW ORLEANS	
Needle Holders.....	300, 309
NIEDERDELLMANN	
Chisels and Gouges, Osteotomes.....	214
NORTHBENT	
Ligature Scissors.....	242
NOTO	
Sponge Holding Forceps.....	23
NOVAK - SCHOECKAERT	
Biopsy Curettes.....	271

NOYES.....	271
Corneal Section, Micro Scissors.....	255
Iris Scissors.....	251

O

O'BRIEN

Fine Scissors.....	237
--------------------	-----

O'CONNOR

Delicate Hooks.....	125
---------------------	-----

OBWEGESER

Chisels and Gouges, Osteotomes.....	214
-------------------------------------	-----

OCHSNER - KOCHER

Artery Forceps.....	143
---------------------	-----

OEHLER

Dissecting Forceps.....	118
-------------------------	-----

OLIVECRONA

Nasal Scissors.....	184
---------------------	-----

Scissors For Vascular and Neuro Surgery.....	230
--	-----

OLLIER

Retractors.....	41
-----------------	----

OLSEN-HEGAR

Needle Holders.....	302, 312
---------------------	----------

OVERHOLT

Dissecting and Ligature Forceps.....	146
--------------------------------------	-----

OVERHOLT - GEISSENDOERFER

Artery, Dissecting and Ligature Forceps.....	145
--	-----

P

PARAMETRIUM

Paramentrium Forceps.....	168
---------------------------	-----

Scissors.....	263
---------------	-----

PARKER

Retractors.....	60, 61
-----------------	--------

PARKER - LANGENBECK

Retractors.....	61
-----------------	----

PATON

Needle Holders.....	327
---------------------	-----

PAUFIQUE

Suture Forceps.....	115
---------------------	-----

PAYR

Suture Instruments.....	336
-------------------------	-----

PEAN

Artery Forceps.....	137
---------------------	-----

PEAN - DELICATE	
Delicate Artery Forceps.....	144
PEDERSON	
Vaginal Specula.....	360
PEERS	
Towel Forceps.....	173
PEET	
Splinter Forceps.....	105
PELKMANN	
Sponge Holding Forceps.....	24
PENNINGTON	
Artery Forceps.....	137
Elevator - Raspatory.....	192
PERRY	
Cotton and Dressing Pliers, Suture Tweezers.....	123
PHANEUF	
Hysterectomy Forceps.....	167
PLESTER	
Antrum Hook.....	128
Flap Knife.....	129
Footplate Hook.....	128
Hook (Scraper).....	127
Selfretaining Retractors.....	72
Sickle Knife.....	129
Suction Cannulas.....	5
Wire Guide.....	128
PLESTER - L	
Selfretaining Retractors.....	72
PLESTER - R	
Selfretaining Retractors.....	72
POLITZER	
Scalpel Handles.....	17
POTTS - DE MARTEL	
Scissors For Vascular and Neuro Surgery.....	229
POTTS-SMITH	
Cartilage - Lobectomy - Enterotomy - Dissecting Scissors.....	231
Dissecting Forceps.....	118
Dressing - Tissue Forceps.....	95
Needle Holders.....	319, 327
Scissors.....	266
Scissors For Vascular and Neuro Surgery.....	228
Scissors For Vascular Surgery.....	226
POZZI	
Uterine Tenaculum Forceps.....	363, 366
PRATT	
Angiotribes, Haemorrhoidal Forceps.....	169
Rectal Specula.....	354

PRESBYTERIAN	
Tubing Clamps.....	174
PRINCE	
Tonsil and Nasal, Goitre Enucleation Scissors.....	232
PROVIDENCE - HOSPITAL	
Artery Forceps.....	140
Q	
QUINBY	
Gum Scissors.....	250
QUIRE	
Ear Forceps.....	32
R	
RAGNELL- DAVIS	
Delicate and Spiral Retractors.....	38
RALK	
Splinter Forceps.....	105
RAMPLEY	
Sponge Holding Forceps.....	27
RANDALL	
Biopsy Curettes.....	271
RECAMIER	
Plasenta - and Ovum Curettes.....	273
Uterine Curettes.....	272
REHN	
Scalpels.....	15
REIL	
Needle Holders.....	322
REILL	
Wine Cutting Pliers, Lateral Cutting Action.....	292
REVERDIN	
Abdominal Retractors.....	85
Suture Instruments.....	329
REYNOLDS	
Dissecting Scissors.....	225
RICARD	
Abdominal Retractors.....	83
RICHARDSON (KELLY)	
Retractors.....	47
RICHARDSON - EASTMAN	
Retractors.....	47

RICHTER	
Operating Scissors.....	217
Selfretaining Retractors.....	73
RICHTER-HEATH	
Clip Applying.....	339
RIGHBY	
ROBERTS	
Artery, Bronchus Forceps.....	152
ROBIN - MASSE	
Abdominal Retractors.....	83
ROCHESTER - CARMALT	
Tonsil Hemostatic, Artery Forceps.....	149
ROCHESTER - PEAN	
Artery Forceps.....	142
ROEDER	
Towel Forceps.....	173
ROSEN	
Hooks.....	127
Knife.....	129
ROTTER	
Suture Instruments.....	334
ROUX	
Retractors.....	60
RUMEL	
Dissecting and Ligature Forceps.....	153
RUSS.MODELL	
Dressing - Tissue Forceps.....	99
RUSSEL - DAVIS	
Tongue Blades.....	201
RYDEL - SEIFFER	
Tuning Forks.....	29
S	
SAMII	
Grasping Forceps	101
SANVENERO	
Dissecting Scissors.....	225
SAROT	
Artery, Bronchus Forceps.....	152
Needle Holders.....	300, 320
SATINSKY	
Scissors For Vascular and Neuro Surgery.....	230
SATTLER	
Muscular - Entropium - Chalazion Forceps.....	116

SAUERBRUCH	
Retractors.....	44, 57
SAUERBRUCH-CORYLLOS	
Rib Rongeurs.....	280
SAUERBRUCH-FREY	
Rib Shears.....	278
SCALP - CONTOUR	
Selfretaining Retractors.....	71
Scalpel Handles.....	7, 8
Scalpels.....	9
SCHAEDEL	
Towel Forceps.....	172
SCHEDE	
Bone Curettes.....	274
SCHINDLER	
Peritoneal Clamp Forceps.....	171
SCHINK	
Scalpels.....	15
SCHMIEDEN	
Suture Instruments.....	332
SCHMIEDEN-PAYR	
Suture Instruments.....	336
SCHMIEDEN - TAYLOR	
Scissors For Vascular and Neuro Surgery.....	229
SCHNIDT - SAWTELL	
Tonsil Hemostatic, Artery Forceps.....	149
SCHOEMAKER	
Tonsil and Nasal, Goitre Enucleation Scissors.....	232
SCHOEMAKER - LOTH	
Ligature Scissors.....	241
SCHRÖDER	
Uterine Tenaculum Forceps.....	365
SCHUHKNECHT	
Selfretaining Retractors.....	66
SCHUKNECHT	
Roller Knife.....	130
Wire Cutting and Crown Scissors.....	243
SCHUMACHER	
Bone Levers.....	370
Episiotomy and Umbilical Scissors.....	234
SCHUMACHER mod. WAGNER	
Bone Levers.....	370
SCHWECKENDIEK	
Tonsil Scissors.....	204
SCOVILLE	
Self - Training Retractors.....	86

SCOVILLE - HAVERFIELD	
Self - Training Retractors.....	86
SEFOND	
Hysterectomy Forceps.....	167
SEGOND - LANDAU	
Hysterectomy Forceps.....	167
SEMB	
Rib Holding Forceps, Bone Cutting Forceps.....	279
Rib Rongeurs.....	280
SEMKEN	
Dissecting Forceps.....	118
Dressing - Tissue Forceps.....	92, 93
SENN - MILLER	
Delicate and Spiral Retractors.....	38
SENNING	
Needle Holders.....	300
SENNING (SWED. PATTERN)	
Needle Holders	309
SEUTIN	
Bandage, Plaster Scissors	247
SHAMBAUGH	
Fenestra Hook	127
Fenestra Hooks.....	127
SHEA	
Curettes.....	132
SHORTBENT	
Ligature Scissors.....	242
SIEBOLD	
Gynecological Scissors.....	220
SIMON	
Bone Curettes.....	276
Retractors.....	45
Scalpels.....	14
SIMS	
Rectal Specula.....	354
Scissors.....	264
Vaginal Specula.....	360
SIMS - MAIER	
Sponge Holding Forceps.....	28
SINGLEY - TUTTLE	
Grasping Forceps.....	98
SMITH	
Bandage and Clothing Scissors.....	246
Wire Cutting and Crown Scissors.....	243
SNELLEN	
Ear Loop.....	30

SNITMAN	
Selfretaining Retractors.....	63
SPENCER	
Ligature Scissors.....	241
SPENCER - WELLS	
Artery Forceps.....	138
SPURLING	
Rongeurs.....	343
ST. BARTS	
Ear Hooks.....	31
ST. CLAIR - THOMPSON	
Adenoid Curettes.....	207
ST. MARKS	
Retractors.....	58
ST. MARTIN	
Suture Forceps.....	115
STACKE	
Ear Probe.....	31
Probes.....	347
STANDARD	
Dressing - Tissue Forceps.....	89
Gum Scissors.....	250
Operating Scissors.....	215
Scissors.....	261, 262
Uterine Tenaculum Forceps.....	365
ST CLAIR THOMPSON	
Raspatory.....	188
STERNUM	
Needle Holders.....	317
STEVENS	
Eye Scissors.....	239
Iris Forceps.....	110
Needle Holders.....	327
STIEGLITZ	
Splinter Forceps.....	105
STILLE	
Bone Rongeurs.....	285
Chisels and Gouges, Osteotomes.....	213
Dressing - Tissue Forceps.....	97
Kidney Pedicle Clamp Forceps.....	160
STILLE - BARRAYA	
Dressing - Tissue Forceps.....	97
STILLE-RUSKIN	
Bone Rongeurs.....	285
STRATTE	
Needle Holders.....	302, 320

STRULLY	
Scissors For Vascular and Neuro Surgery.....	228
SULLIVAN	
Gum Scissors.....	250
SYME	
Tonsil Dissector.....	203
T	
TÄGER	
Bone Levers.....	369
TAYLOR	
Delicate and Spiral Retractors.....	38
Dressing - Tissue Forceps.....	93
Self - Training Retractors.....	86
TERRIER	
Artery Forceps.....	138
TERSON	
Capsular Forceps.....	113
TESSIER	
Bone Curettes.....	276
THIERSCH	
Scalpels.....	15
THORBURN	
Sickle Knife.....	129
THOREK	
Dissecting Scissors.....	224
TIECK - HALLE	
Nasal Specula.....	180
TILLEY HENCKEL	
Ethmoidal Forceps.....	191
TOBOLD	
Tongue Depressors.....	199
TOENNIS	
Dissectign and Ligature Forceps.....	158
Needle Holders.....	305, 315
Scissors For Vascular and Neuro Surgery.....	229
TOENNIS - ADSON	
Scissors.....	270
Scissors For Vascular and Neuro Surgery	229
TOHOKU - JAPAN	
Towel Forceps.....	173
TRIVERS	
Selfretaining Retractors.....	65
TRELAT	
Vaginal Specula.....	359

TRÉLAT	
Suture Instruments.....	333
TROELTSCH (WILDE)	
Ear and Nose Dressing Forceps.....	107
TROUSSEAU	
Tracheal Dilators.....	212
TROUTMAN	
Iris Forceps.....	112
Needle Holders.....	322
Tenotomy, Corneal Scissors.....	253
TROUTMAN - CHRIS	
Razor Blade Breakers.....	16
TÜBINGER MODELL	
Selfretaining Retractors.....	73
TUFFIER	
Retractors.....	50
Seizing Forceps, Blood Vessel Clamp, Scalp Flap Forceps.....	136

U

UCKERMANN	
Probes.....	349
ULRICH	
Sponge Holding Forceps.....	19
UNIVERSAL	
Bandage and Clothing Scissors.....	245
Scissors.....	270
Wire Cutting and Crown Scissors.....	243

V

VANNAS	
Secondary Cataract Scissors.....	252
VANNAS MOD. TÜBINGEN	
Secondary Cataract Scissors.....	252
VASCULAR	
.....	314
VEBRUGGE - MÜLLER	
Bone Levers.....	372
VENA ARTERIA	
Bulldog Clamps.....	134
VERBRUGGE	
Bone Holding Forceps.....	281
VIRCHOW	
Scalpels.....	13

WISE	
Micro - Suture Tying Forceps.....	102
VOLKLANN	
Retractors.....	39
VOLKMANN	
Bone Curettes.....	274
Retractors.....	40
W	
WACHENFELDT	
Clip Applying.....	339
WAGENER	
Ear Hooks.....	31
WAGNER	
Bone Levers.....	373
Fine Operating Scissors.....	235
WALDMANN	
Episiotomy and Umbilical Scissors.....	234
WALTER	
Chisel and Gouges, Osteotomes.....	213
Osteotomes.....	195
WALTER - CARMALT	
Splinter Forceps.....	104
WALTON	
Fine Scissors.....	237
Selfretaining Retractors.....	74
Sponge Holding Forceps.....	28
WANGENSTEEN	
Dissecting Forceps.....	120
Dressing - Tissue Forceps.....	97
Needle Holders.....	302, 320
WATSON - CHEYNE	
Elevator - Raspatory.....	187
WEBSTER	
Needle Holders.....	298, 310
WEDER	
Tongue Depressors.....	199
WEIL - BLAKESLEY	
Ethmoidal Forceps.....	191
WEITLANER	
Selfretaining Retractors.....	64
WEITLANER - BABY	
Selfretaining Retractors.....	64
WERTHEIM	
Dissecting and Ligature. Hysterectomy Forceps.....	163

Gynecological and Abdominal Scissors.....	219
Hysterectomy Forceps.....	164
Needle Holders.....	302, 312
WERTHEM - CULLEN	
Hysterectomy Forceps.....	166
WESTCOTT	
Corneal Section, Micro Scissors.....	255
Tenotomy, Corneal Scissors.....	253
WESTERMARK	
Sponge Holding Forceps.....	21
WIENER MODELL	
Nasal Specula.....	181
WIKSTROEM	
Dissecting and Ligature. Hysterectomy Forceps.....	163
WILDE	
Nasal Polypus.....	183
WILLET - MARTEL	
Seizing Forceps, Blood Vessel Clamp, Scalp Flap Forceps.....	136
WILLIGER	
Bone Curettes.....	274
WILSON	
Uterine Tenaculum Forceps.....	366
WOLF	
Plaster Spreader, Plaster Breakers.....	289
WULLSTEIN	
Micro Forceps.....	178
Selfretaining Retractors.....	66
WULLSTEIN MICRO	
Suction Cannulas.....	5

Y

YASARGIL	
Galea Hooks, Handdrill.....	345
YASARGIL - NICOLA	
Forceps.....	211
YOUNG-HRYNTSCHAK	
Needle Holders.....	306
YOUNG-MILLIN	
Needle Holders.....	306

Z

ZAUFAL	
Ear Loop.....	30

ZAUFEL - JANSEN	
Ear Hooks.....	31
ZENKER	
Dissectign and Ligature Forceps.....	154
Retractors.....	55
ZIEGLER	
Cilia Forceps.....	106
ZWEIFEL	
Needle Holders.....	304, 316

INDEX

OEM NO	PAGE	OEM NO	PAGE	OEM NO	PAGE	OEM NO	PAGE
AS - 400 - 04	5	BS - 166 - 09	16	BS - 300 - 06	10	BS - 504 - 17	17
AS - 400 - 06	5	BS - 167 - 11	16	BS - 301 - 01	10	CM - 201 - 22	19
AS - 400 - 08	5	BS - 168 - 13	16	BS - 301 - 02	10	CM - 201 - 25	19
BS - 100 - 13	12	BS - 200 - 03	7	BS - 301 - 03	10	CM - 202 - 22	19
BS - 100 - 16	12	BS - 201 - 03	7	BS - 301 - 04	10	CM - 203 - 25	19
BS - 100 - 19	12	BS - 201 - 04	7	BS - 301 - 05	10	CM - 205 - 20	20
BS - 100 - 22	12	BS - 202 - 13	7	BS - 301 - 06	10	CM - 205 - 22	20
BS - 100 - 28	12	BS - 203 - 14	7	BS - 301 - 07	10	CM - 205 - 25	20
BS - 101 - 16	12	BS - 210 - 07	8	BS - 301 - 08	10	CM - 205 - 27	20
BS - 102 - 19	12	BS - 211 - 07	8	BS - 301 - 09	10	CM - 206 - 20	20
BS - 102 - 22	12	BS - 212 - 16	8	BS - 301 - 10	10	CM - 206 - 22	20
BS - 103 - 17	12	BS - 213 - 08	8	BS - 302 - 01	11	CM - 206 - 25	20
BS - 103 - 20	12	BS - 214 - 09	8	BS - 302 - 02	11	CM - 206 - 27	20
BS - 103 - 22	12	BS - 250 - 01	9	BS - 302 - 03	11	CM - 207 - 24	21
BS - 150 - 16	13	BS - 250 - 03	9	BS - 302 - 04	11	CM - 208 - 24	21
BS - 150 - 20	13	BS - 250 - 05	9	BS - 302 - 05	11	CM - 209 - 23	21
BS - 151 - 13	14	BS - 250 - 07	9	BS - 302 - 06	11	CM - 210 - 26	22
BS - 152 - 13	14	BS - 250 - 09	9	BS - 302 - 07	11	CM - 211 - 26	22
BS - 155 - 01	14	BS - 250 - 10	9	BS - 302 - 08	11	CM - 212 - 26	22
BS - 155 - 02	14	BS - 250 - 12	9	BS - 302 - 09	11	CM - 213 - 25	23
BS - 155 - 03	14	BS - 250 - 14	9	BS - 302 - 15	11	CM - 214 - 24	23
BS - 155 - 04	14	BS - 250 - 16	9	BS - 302 - 16	11	CM - 215 - 28	23
BS - 160 - 20	15	BS - 250 - 18	9	BS - 500 - 16	17	CM - 216 - 25	24
BS - 161 - 25	15	BS - 300 - 01	10	BS - 501 - 16	17	CM - 217 - 25	24
BS - 162 - 01	15	BS - 300 - 02	10	BS - 501 - 18	17	CM - 218 - 32	24
BS - 162 - 02	15	BS - 300 - 03	10	BS - 501 - 19	17	CM - 219 - 21	25
BS - 162 - 30	15	BS - 300 - 04	10	BS - 502 - 16	17	CM - 220 - 25	25
BS - 165 - 09	16	BS - 300 - 05	10	BS - 503 - 17	17	CM - 221 - 20	25

INDEX

OEM NO	PAGE	OEM NO	PAGE	OEM NO	PAGE	OEM NO	PAGE
CM - 222 - 20	25	DP - 100 - 18	29	DP - 125 - 18	31	EK - 202 - 02	33
CM - 223 - 18	26	DP - 100 - 44	29	DP - 130 - 15	32	EK - 202 - 03	33
CM - 223 - 20	26	DP - 101 - 12	29	DP - 140 - 15	32	EK - 202 - 04	33
CM - 223 - 25	26	DP - 101 - 25	29	DP - 131 - 15	32	EK - 203 - 01	33
CM - 224 - 18	26	DP - 102 - 12	29	DP - 141 - 15	32	EK - 203 - 02	33
CM - 224 - 20	26	DP - 103 - 12	29	DP - 132 - 15	32	EK - 203 - 03	33
CM - 224 - 25	26	DP - 104 - 12	29	DP - 133 - 15	32	EK - 203 - 04	33
CM - 225 - 18	26	DP - 105 - 16	30	DP - 134 - 15	32	EK - 204 - 01	33
CM - 225 - 20	26	DP - 105 - 16	30	DP - 140 - 15	32	EK - 204 - 02	33
CM - 225 - 25	26	DP - 106 - 16	30	DP - 141 - 15	32	EK - 204 - 03	33
CM - 226 - 18	26	DP - 106 - 16	30	DP - 142 - 15	32	EK - 204 - 04	33
CM - 226 - 20	26	DP - 107 - 13	30	DP - 143 - 15	32	EK - 205 - 02	34
CM - 226 - 25	26	DP - 107 - 16	30	DP - 144 - 15	32	EK - 205 - 03	34
CM - 227 - 25	27	DP - 108 - 16	30	DP - 150 - 90	32	EK - 205 - 04	34
CM - 228 - 25	27	DP - 109 - 18	30	DP - 151 - 90	32	EK - 206 - 02	34
CM - 229 - 25	27	DP - 110 - 14	31	EC - 947 - 01	116	EK - 206 - 03	34
CM - 230 - 28	28	DP - 111 - 14	31	EC - 947 - 02	116	EK - 206 - 04	34
CM - 231 - 28	28	DP - 112 - 14	31	EC - 948 - 01	116	EK - 207 - 02	34
CM - 233 - 17	28	DP - 112 - 14	31	EC - 948 - 02	116	EK - 207 - 05	34
DP - 100 - 01	29	DP - 113 - 15	31	EK - 200 - 01	33	EK - 207 - 07	34
DP - 100 - 02	29	DP - 114 - 15	31	EK - 200 - 02	33	EK - 207 - 10	34
DP - 100 - 03	29	DP - 115 - 15	31	EK - 200 - 03	33	EK - 208 - 01	34
DP - 100 - 04	29	DP - 116 - 15	31	EK - 200 - 04	33	EK - 208 - 02	34
DP - 100 - 05	29	DP - 116 - 15	31	EK - 201 - 01	33	EK - 209 - 13	34
DP - 100 - 06	29	DP - 117 - 15	31	EK - 201 - 02	33	EK - 210 - 13	34
DP - 100 - 12	29	DP - 117 - 15	31	EK - 201 - 03	33	EK - 211 - 13	34
DP - 100 - 14	29	DP - 120 - 10	31	EK - 201 - 04	33	EK - 212 - 01	35
DP - 100 - 16	29	DP - 125 - 14	31	EK - 202 - 01	33	EK - 212 - 03	35

INDEX

OEM NO	PAGE	OEM NO	PAGE	OEM NO	PAGE	OEM NO	PAGE
EK - 212 - 05	35	EK - 219 - 08	36	EK - 229 - 06	39	EK - 235 - 21	40
EK - 213 - 02	35	EK - 219 - 10	36	EK - 230 - 01	39	EK - 236 - 21	40
EK - 213 - 04	35	EK - 219 - 12	36	EK - 230 - 02	39	EK - 237 - 20	40
EK - 213 - 06	35	EK - 219 - 14	36	EK - 230 - 03	39	EK - 238 - 20	40
EK - 214 - 10	35	EK - 219 - 16	36	EK - 230 - 04	39	EK - 240 - 08	40
EK - 214 - 20	35	EK - 219 - 18	36	EK - 230 - 06	39	EK - 241 - 08	40
EK - 215 - 10	35	EK - 220 - 09	37	EK - 231 - 01	39	EK - 242 - 35	40
EK - 215 - 17	35	EK - 220 - 11	37	EK - 231 - 02	39	EK - 242 - 43	40
EK - 215 - 20	35	EK - 220 - 13	37	EK - 231 - 03	39	EK - 242 - 45	40
EK - 215 - 22	35	EK - 220 - 15	37	EK - 231 - 04	39	EK - 350 - 30	41
EK - 216 - 08	36	EK - 220 - 18	37	EK - 231 - 06	39	EK - 350 - 60	41
EK - 216 - 10	36	EK - 221 - 09	37	EK - 232 - 01	39	EK - 351 - 40	41
EK - 216 - 12	36	EK - 221 - 11	37	EK - 232 - 02	39	EK - 351 - 50	41
EK - 216 - 14	36	EK - 221 - 13	37	EK - 232 - 03	39	EK - 351 - 60	41
EK - 216 - 16	36	EK - 221 - 15	37	EK - 232 - 04	39	EK - 351 - 70	41
EK - 216 - 18	36	EK - 221 - 18	37	EK - 232 - 06	39	EK - 352 - 01	42
EK - 217 - 08	36	EK - 222 - 15	38	EK - 232 - 08	39	EK - 352 - 02	42
EK - 217 - 10	36	EK - 223 - 15	38	EK - 233 - 01	39	EK - 352 - 03	42
EK - 217 - 12	36	EK - 224 - 16	38	EK - 233 - 03	39	EK - 353 - 01	42
EK - 217 - 14	36	EK - 225 - 16	38	EK - 233 - 04	39	EK - 353 - 01	42
EK - 217 - 16	36	EK - 226 - 14	38	EK - 233 - 06	39	EK - 353 - 01	42
EK - 217 - 18	36	EK - 227 - 20	38	EK - 233 - 08	39	EK - 353 - 02	42
EK - 218 - 08	36	EK - 228 - 07	38	EK - 234 - 01	39	EK - 353 - 03	42
EK - 218 - 10	36	EK - 228 - 10	38	EK - 234 - 02	39	EK - 353 - 04	42
EK - 218 - 12	36	EK - 229 - 01	39	EK - 234 - 03	39	EK - 353 - 05	42
EK - 218 - 14	36	EK - 229 - 02	39	EK - 234 - 04	39	EK - 354 - 01	42
EK - 218 - 16	36	EK - 229 - 03	39	EK - 234 - 06	39	EK - 354 - 02	42
EK - 218 - 18	36	EK - 229 - 04	39	EK - 234 - 08	39	EK - 354 - 03	42

INDEX

OEM NO	PAGE	OEM NO	PAGE	OEM NO	PAGE	OEM NO	PAGE
EK - 354 - 04	42	EK - 370 - 22	47	EK - 388 - 60	55	EK - 400 - 02	61
EK - 355 - 01	43	EK - 371 - 01	47	EK - 388 - 75	55	EK - 401 - 00	61
EK - 355 - 02	43	EK - 371 - 02	47	EK - 389 - 16	56	EK - 401 - 01	61
EK - 355 - 03	43	EK - 371 - 03	47	EK - 389 - 25	56	EK - 401 - 02	61
EK - 355 - 04	43	EK - 371 - 04	47	EK - 389 - 50	56	EK - 402 - 19	61
EK - 355 - 05	43	EK - 371 - 05	47	EK - 390 - 20	56	EK - 420 - 05	62
EK - 355 - 06	43	EK - 373 - 01	48	EK - 390 - 30	56	EK - 420 - 07	62
EK - 355 - 07	43	EK - 373 - 02	48	EK - 390 - 40	56	EK - 421 - 05	62
EK - 355 - 08	43	EK - 373 - 03	48	EK - 391 - 22	57	EK - 421 - 07	62
EK - 355 - 09	43	EK - 373 - 04	48	EK - 391 - 38	57	EK - 422 - 10	62
EK - 356 - 18	44	EK - 373 - 05	48	EK - 391 - 65	57	EK - 422 - 10	62
EK - 356 - 20	44	EK - 373 - 06	48	EK - 392 - 25	57	EK - 424 - 07	62
EK - 356 - 25	44	EK - 377 - 25	50	EK - 393 - 01	58	EK - 424 - 10	62
EK - 356 - 30	44	EK - 378 - 23	50	EK - 393 - 02	58	EK - 425 - 07	62
EK - 356 - 40	44	EK - 380 - 26	51	EK - 393 - 03	58	EK - 425 - 10	62
EK - 357 - 01	44	EK - 383 - 01	52	EK - 394 - 12	59	EK - 426 - 10	63
EK - 357 - 02	44	EK - 383 - 02	52	EK - 394 - 50	59	EK - 427 - 10	63
EK - 357 - 03	44	EK - 383 - 03	52	EK - 394 - 90	59	EK - 428 - 10	63
EK - 358 - 25	45	EK - 383 - 04	52	EK - 397 - 00	60	EK - 429 - 10	63
EK - 359 - 28	45	EK - 383 - 05	52	EK - 397 - 05	60	EK - 430 - 10	63
EK - 360 - 22	45	EK - 383 - 06	52	EK - 398 - 00	60	EK - 431 - 10	63
EK - 360 - 27	45	EK - 384 - 07	53	EK - 398 - 01	60	EK - 432 - 14	64
EK - 366 - 18	46	EK - 384 - 08	53	EK - 398 - 02	60	EK - 433 - 13	64
EK - 367 - 19	46	EK - 384 - 09	53	EK - 399 - 00	61	EK - 434 - 10	64
EK - 368 - 20	46	EK - 385 - 01	54	EK - 399 - 01	61	EK - 437 - 00	65
EK - 369 - 17	47	EK - 385 - 05	54	EK - 399 - 02	61	EK - 438 - 00	65
EK - 369 - 22	47	EK - 386 - 28	54	EK - 400 - 00	61	EK - 437 - 19	65
EK - 370 - 17	47	EK - 388 - 35	55	EK - 400 - 01	61	EK - 437 - 25	65

INDEX

OEM NO	PAGE	OEM NO	PAGE	OEM NO	PAGE	OEM NO	PAGE
EK - 437 - 32	65	EK - 475 - 10	72	EK - 494 - 30	78	EK - 505 - 16	81
EK - 439 - 13	65	EK - 475 - 13	72	EK - 494 - 40	78	EK - 507 - 10	82
EK - 440 - 13	65	EK - 476 - 10	72	EK - 495 - 01	78	EK - 508 - 12	82
EK - 441 - 21	65	EK - 476 - 13	72	EK - 495 - 02	78	EK - 509 - 12	82
EK - 442 - 14	66	EK - 477 - 10	72	EK - 495 - 03	78	EK - 510 - 12	82
EK - 443 - 14	66	EK - 477 - 13	72	EK - 497 - 38	79	EK - 511 - 28	83
EK - 446 - 15	66	EK - 478 - 16	73	EK - 497 - 50	79	EK - 511 - 30	83
EK - 447 - 15	66	EK - 478 - 18	73	EK - 498 - 45	79	EK - 512 - 00	83
EK - 448 - 22	66	EK - 479 - 16	73	EK - 498 - 60	79	EK - 514 - 80	84
EK - 449 - 22	66	EK - 480 - 17	73	EK - 499 - 35	79	EK - 516 - 80	84
EK - 450 - 20	67	EK - 481 - 17	73	EK - 499 - 50	79	EK - 550 - 20	85
EK - 451 - 20	67	EK - 482 - 01	74	EK - 500 - 01	80	EK - 555 - 29	85
EK - 452 - 20	67	EK - 482 - 02	74	EK - 500 - 40	80	EK - 650 - 00	87
EK - 453 - 27	67	EK - 483 - 01	74	EK - 500 - 40	80	EK - 650 - 01	87
EK - 454 - 27	67	EK - 484 - 02	74	EK - 500 - 50	80	EK - 650 - 02	87
EK - 455 - 27	67	EK - 485 - 10	75	EK - 500 - 50	80	EK - 650 - 03	87
EK - 456 - 27	68	EK - 486 - 10	75	EK - 501 - 75	80	EK - 650 - 04	87
EK - 457 - 01	68	EK - 487 - 14	75	EK - 501 - 80	80	EK - 660 - 00	87
EK - 457 - 02	68	EK - 488 - 16	75	EK - 502 - 01	80	EK - 660 - 55	86
EK - 466 - 33	70	EK - 489 - 00	76	EK - 502 - 47	80	EK - 665 - 26	87
EK - 467 - 33	70	EK - 489 - 01	76	EK - 502 - 50	80	EK - 666 - 37	86
EK - 467 - 14	71	EK - 489 - 01	76	EK - 502 - 76	80	EK - 667 - 52	86
EK - 468 - 14	71	EK - 490 - 09	76	EK - 503 - 01	80	EK - 670 - 00	86
EK - 470 - 19	71	EK - 491 - 18	76	EK - 503 - 02	80	EK - 670 - 01	86
EK - 472 - 01	71	EK - 492 - 18	77	EK - 504 - 00	81	EK - 670 - 02	86
EK - 472 - 02	71	EK - 493 - 03	77	EK - 504 - 23	81	EK - 670 - 03	86
EK - 474 - 01	72	EK - 494 - 01	78	EK - 504 - 30	81	FO - 100 - 10	89
EK - 474 - 02	72	EK - 494 - 30	78	EK - 505 - 16	81	FO - 100 - 11	89

INDEX

OEM NO	PAGE	OEM NO	PAGE	OEM NO	PAGE	OEM NO	PAGE
FO-100-11	91	FO - 130 - 14	90	FO - 201 - 15	91	FO - 243 - 17	93
FO-100-13	89	FO - 131 - 14	90	FO - 202 - 12	91	FO - 245 - 14	93
FO-100-14	89	FO - 132 - 14	90	FO - 202 - 15	91	FO - 245 - 20	93
FO-100-14	91	FO - 133 - 14	90	FO - 203 - 12	91	FO - 246 - 14	93
FO-100-16	89	FO - 142 - 12	91	FO - 203 - 15	91	FO - 246 - 20	93
FO-100-18	89	FO - 142 - 13	91	FO - 220 - 12	92	FO - 300 - 18	94
FO-100-18	91	FO - 142 - 14	91	FO - 221 - 12	92	FO - 301 - 18	94
FO-100-20	89	FO - 142 - 15	91	FO - 221 - 13	90	FO - 310 - 18	94
FO-100-25	89	FO - 144 - 13	91	FO - 222 - 07	92	FO - 311 - 18	94
FO-100-25	91	FO - 144 - 14	91	FO - 222 - 09	92	FO - 320 - 17	94
FO-100-30	89	FO - 144 - 15	91	FO - 223 - 09	92	FO - 321 - 17	94
FO-100-30	91	FO - 146 - 12	91	FO - 224 - 01	92	FO - 325 - 17	94
FO-110-10	89	FO - 146 - 13	91	FO - 224 - 02	92	FO - 326 - 17	94
FO-110-11	89	FO - 146 - 14	91	FO - 225 - 15	92	FO - 350 - 18	95
FO-110-13	89	FO - 146 - 15	91	FO - 226 - 12	92	FO - 350 - 21	95
FO-110-14	89	FO - 146 - 18	91	FO - 226 - 15	92	FO - 350 - 25	95
FO-110-16	89	FO - 146 - 21	91	FO - 227 - 12	92	FO - 351 - 18	95
FO-110-18	89	FO - 146 - 25	91	FO - 227 - 15	92	FO - 351 - 21	95
FO-110-20	89	FO - 146 - 31	91	FO - 228 - 12	93	FO - 351 - 25	95
FO-110-25	89	FO - 148 - 12	91	FO - 228 - 15	93	FO - 360 - 18	95
FO-110-30	89	FO - 148 - 13	91	FO - 229 - 15	93	FO - 360 - 21	95
FO - 112 - 13	90	FO - 148 - 14	91	FO - 230 - 17	93	FO - 360 - 25	95
FO - 112 - 14	90	FO - 148 - 15	91	FO - 231 - 17	93	FO - 361 - 18	95
FO - 112 - 16	90	FO - 148 - 18	91	FO - 232 - 17	93	FO - 361 - 21	95
FO - 113 - 13	90	FO - 148 - 21	91	FO - 233 - 17	93	FO - 361 - 25	95
FO - 113 - 14	90	FO - 148 - 25	91	FO - 240 - 17	93	FO - 370 - 21	95
FO - 113 - 16	90	FO - 148 - 31	91	FO - 241 - 17	93	FO - 371 - 20	95
FO - 120 - 13	90	FO - 201 - 12	91	FO - 242 - 17	93	FO - 375 - 20	95

INDEX

OEM NO	PAGE	OEM NO	PAGE	OEM NO	PAGE	OEM NO	PAGE
FO - 376 - 20	95	FO - 402 - 15	118	FO - 417 - 04	121	FO - 422 - 02	122
FO - 380 - 15	96	FO - 403 - 15	118	FO - 417 - 05	121	FO - 422 - 03	122
FO - 380 - 20	96	FO - 404 - 15	118	FO - 417 - 06	121	FO - 422 - 04	122
FO - 380 - 25	96	FO - 405 - 12	119	FO - 418 - 01	121	FO - 422 - 05	122
FO - 385 - 20	96	FO - 405 - 15	119	FO - 418 - 02	121	FO - 422 - 06	122
FO - 386 - 20	96	FO - 406 - 12	119	FO - 418 - 03	121	FO - 423 - 01	123
FO - 387 - 20	96	FO - 406 - 15	119	FO - 418 - 04	121	FO - 423 - 02	123
FO - 388 - 20	96	FO - 407 - 17	119	FO - 418 - 05	121	FO - 423 - 03	123
FO - 390 - 23	97	FO - 408 - 18	119	FO - 418 - 06	121	FO - 423 - 04	123
FO - 392 - 18	97	FO - 409 - 18	119	FO - 419 - 01	122	FO - 424 - 01	123
FO - 393 - 11	97	FO - 412 - 18	120	FO - 419 - 02	122	FO - 424 - 02	123
FO - 393 - 13	97	FO - 413 - 15	120	FO - 419 - 03	122	FO - 425 - 01	123
FO - 393 - 15	97	FO - 413 - 23	120	FO - 419 - 04	122	FO - 425 - 02	123
FO - 394 - 15	97	FO - 415 - 01	121	FO - 419 - 05	122	FO - 426 - 01	124
FO - 395 - 15	97	FO - 415 - 02	121	FO - 419 - 06	122	FO - 426 - 01	124
FO - 400 - 15	118	FO - 415 - 03	121	FO - 420 - 01	122	FO - 426 - 02	124
FO - 400 - 18	118	FO - 415 - 04	121	FO - 420 - 02	122	FO - 426 - 02	124
FO - 400 - 20	118	FO - 415 - 05	121	FO - 420 - 03	122	FO - 427 - 01	124
FO - 400 - 23	118	FO - 415 - 06	121	FO - 420 - 04	122	FO - 427 - 02	124
FO - 400 - 25	118	FO - 416 - 01	121	FO - 420 - 05	122	FO - 500 - 01	98
FO - 401 - 14	118	FO - 416 - 02	121	FO - 420 - 06	122	FO - 500 - 02	98
FO - 401 - 16	118	FO - 416 - 03	121	FO - 421 - 01	122	FO - 500 - 03	98
FO - 401 - 18	118	FO - 416 - 04	121	FO - 421 - 02	122	FO - 501 - 23	98
FO - 401 - 20	118	FO - 416 - 05	121	FO - 421 - 03	122	FO - 502 - 23	98
FO - 401 - 25	118	FO - 416 - 06	121	FO - 421 - 04	122	FO - 503 - 23	98
FO - 401 - 30	118	FO - 417 - 01	121	FO - 421 - 05	122	FO - 510 - 15	99
FO - 402 - 12	118	FO - 417 - 02	121	FO - 421 - 06	122	FO - 511 - 10	99
FO - 402 - 12	118	FO - 417 - 03	121	FO - 422 - 01	122	FO - 513 - 10	99

INDEX

OEM NO	PAGE	OEM NO	PAGE	OEM NO	PAGE	OEM NO	PAGE
FO - 514 - 10	99	FO - 602 - 18	102	FO - 622 - 08	104	FO - 626 - 10	105
FO - 516 - 10	99	FO - 603 - 12	102	FO - 622 - 09	104	FO - 626 - 10	105
FO - 518 - 14	99	FO - 603 - 13	102	FO - 622 - 10	104	FO - 626 - 11	105
FO - 518 - 16	99	FO - 604 - 13	102	FO - 622 - 11	104	FO - 626 - 12	105
FO - 518 - 20	99	FO - 605 - 14	103	FO - 622 - 12	104	FO - 626 - 14	105
FO - 519 - 14	99	FO - 606 - 14	103	FO - 622 - 14	104	FO - 627 - 08	105
FO - 520 - 18	99	FO - 607 - 14	103	FO - 623 - 08	104	FO - 627 - 09	105
FO - 521 - 18	99	FO - 608 - 12	103	FO - 623 - 09	104	FO - 627 - 10	105
FO - 530 - 00	100	FO - 609 - 12	103	FO - 623 - 10	104	FO - 627 - 11	105
FO - 530 - 01	100	FO - 612 - 18	103	FO - 623 - 10	104	FO - 627 - 12	105
FO - 530 - 02	100	FO - 613 - 18	103	FO - 623 - 11	104	FO - 627 - 14	105
FO - 530 - 03	100	FO - 614 - 11	103	FO - 623 - 12	104	FO - 650 - 13	105
FO - 530 - 04	100	FO - 616 - 10	104	FO - 623 - 14	104	FO - 651 - 13	105
FO - 530 - 05	100	FO - 617 - 10	104	FO - 624 - 08	105	FO - 652 - 13	105
FO - 530 - 07	100	FO - 618 - 10	104	FO - 624 - 09	105	FO - 653 - 13	105
FO - 530 - 10	100	FO - 619 - 10	104	FO - 624 - 10	105	FO - 654 - 15	105
FO - 530 - 11	100	FO - 620 - 08	104	FO - 624 - 11	105	FO - 655 - 15	105
FO - 531 - 01	101	FO - 620 - 09	104	FO - 624 - 12	105	FO - 675 - 08	106
FO - 531 - 02	101	FO - 620 - 10	104	FO - 624 - 14	105	FO - 676 - 09	106
FO - 532 - 01	101	FO - 620 - 11	104	FO - 625 - 08	105	FO - 677 - 09	106
FO - 532 - 02	101	FO - 620 - 12	104	FO - 625 - 09	105	FO - 678 - 09	106
FO - 533 - 01	101	FO - 620 - 14	104	FO - 625 - 10	105	FO - 679 - 09	106
FO - 533 - 02	101	FO - 621 - 08	104	FO - 625 - 10	105	FO - 680 - 10	106
FO - 534 - 01	101	FO - 621 - 09	104	FO - 625 - 11	105	FO - 681 - 09	106
FO - 534 - 02	101	FO - 621 - 10	104	FO - 625 - 12	105	FO - 700 - 11	107
FO - 535 - 20	101	FO - 621 - 11	104	FO - 625 - 14	105	FO - 700 - 12	107
FO - 601 - 09	102	FO - 621 - 12	104	FO - 626 - 08	105	FO - 700 - 15	107
FO - 602 - 14	102	FO - 621 - 14	104	FO - 626 - 09	105	FO - 700 - 18	107

INDEX

OEM NO	PAGE	OEM NO	PAGE	OEM NO	PAGE	OEM NO	PAGE
FO - 701 - 12	107	FO - 719 - 05	109	FO - 817 - 01	110	FO - 840 - 01	113
FO - 701 - 15	107	FO - 719 - 07	109	FO - 817 - 02	110	FO - 840 - 02	113
FO - 701 - 18	107	FO - 719 - 10	109	FO - 817 - 03	110	FO - 841 - 07	113
FO - 702 - 11	107	FO - 719 - 12	109	FO - 818 - 07	110	FO - 842 - 01	114
FO - 702 - 13	107	FO - 719 - 14	109	FO - 819 - 08	111	FO - 842 - 02	114
FO - 703 - 14	107	FO - 801 - 07	109	FO - 820 - 08	111	FO - 843 - 09	114
FO - 704 - 14	107	FO - 801 - 10	109	FO - 821 - 08	111	FO - 844 - 09	114
FO - 710 - 20	108	FO - 801 - 12	109	FO - 822 - 08	111	FO - 845 - 11	114
FO - 711 - 20	108	FO - 802 - 07	109	FO - 823 - 07	111	FO - 846 - 11	114
FO - 712 - 22	108	FO - 802 - 10	109	FO - 824 - 09	111	FO - 847 - 11	114
FO - 713 - 22	108	FO - 802 - 12	109	FO - 825 - 01	111	FO - 848 - 02	114
FO - 714 - 10	108	FO - 803 - 07	109	FO - 825 - 02	111	FO - 848 - 03	114
FO - 715 - 10	108	FO - 803 - 10	109	FO - 826 - 08	112	FO - 849 - 10	114
FO - 716 - 05	109	FO - 803 - 12	109	FO - 827 - 08	112	FO - 940 - 05	115
FO - 716 - 07	109	FO - 804 - 07	109	FO - 828 - 08	112	FO - 940 - 07	115
FO - 716 - 10	109	FO - 804 - 10	109	FO - 829 - 08	112	FO - 940 - 10	115
FO - 716 - 12	109	FO - 804 - 12	109	FO - 830 - 08	112	FO - 941 - 07	115
FO - 716 - 14	109	FO - 805 - 07	109	FO - 831 - 07	112	FO - 942 - 01	115
FO - 717 - 05	109	FO - 805 - 10	109	FO - 832 - 07	112	FO - 942 - 03	115
FO - 717 - 07	109	FO - 805 - 12	109	FO - 833 - 07	112	FO - 942 - 05	115
FO - 717 - 10	109	FO - 806 - 07	109	FO - 834 - 07	112	FO - 942 - 10	115
FO - 717 - 12	109	FO - 806 - 10	109	FO - 835 - 07	112	FO - 942 - 15	115
FO - 717 - 14	109	FO - 806 - 12	109	FO - 836 - 07	113	FO - 943 - 01	115
FO - 718 - 05	109	FO - 815 - 01	110	FO - 837 - 09	113	FO - 943 - 03	115
FO - 718 - 07	109	FO - 815 - 02	110	FO - 838 - 01	113	FO - 943 - 05	115
FO - 718 - 10	109	FO - 816 - 01	110	FO - 838 - 02	113	FO - 943 - 10	115
FO - 718 - 12	109	FO - 816 - 02	110	FO - 839 - 01	113	FO - 943 - 15	115
FO - 718 - 14	109	FO - 816 - 03	110	FO - 839 - 02	113	FO - 944 - 01	115

INDEX

OEM NO	PAGE	OEM NO	PAGE	OEM NO	PAGE	OEM NO	PAGE
FO - 944 - 02	115	FO - 954 - 20	117	HM - 406 - 14	143	HM - 422 - 04	145
FO - 945 - 10	115	FO - 954 - 24	117	HM - 406 - 16	143	HM - 422 - 05	145
FO - 946 - 10	115	FO - 954 - 30	117	HM - 406 - 18	143	HM - 422 - 06	145
FO - 947 - 01	116	HM - 400 - 14	142	HM - 406 - 20	143	HM - 422 - 07	145
FO - 947 - 02	116	HM - 400 - 15	133	HM - 406 - 22	143	HM - 422 - 15	148
FO - 948 - 01	116	HM - 400 - 16	142	HM - 406 - 24	143	HM - 423 - 04	145
FO - 948 - 02	116	HM - 400 - 18	142	HM - 406 - 26	143	HM - 423 - 05	145
FO - 949 - 09	116	HM - 400 - 20	142	HM - 406 - 30	143	HM - 423 - 06	145
FO - 950 - 01	116	HM - 400 - 22	142	HM - 410 - 16	133	HM - 423 - 07	145
FO - 950 - 02	116	HM - 400 - 24	142	HM - 410 - 18	133	HM - 423 - 15	148
FO - 950 - 16	117	HM - 400 - 26	142	HM - 410 - 20	133	HM - 424 - 13	145
FO - 950 - 20	117	HM - 400 - 30	142	HM - 410 - 24	133	HM - 424 - 14	148
FO - 950 - 24	117	HM - 401 - 14	142	HM - 415 - 14	147	HM - 425 - 14	148
FO - 951 - 01	116	HM - 401 - 16	142	HM - 415 - 18	147	HM - 425 - 16	137
FO - 951 - 02	116	HM - 401 - 18	142	HM - 418 - 18	147	HM - 426 - 18	146
FO - 951 - 03	116	HM - 401 - 20	142	HM - 418 - 19	147	HM - 426 - 20	146
FO - 951 - 16	117	HM - 401 - 22	142	HM - 419 - 18	147	HM - 426 - 21	146
FO - 951 - 20	117	HM - 401 - 24	142	HM - 420 - 01	145	HM - 426 - 22	146
FO - 951 - 24	117	HM - 401 - 26	142	HM - 420 - 02	145	HM - 427 - 13	144
FO - 951 - 30	117	HM - 401 - 30	142	HM - 420 - 03	145	HM - 427 - 14	144
FO - 952 - 16	117	HM - 405 - 14	143	HM - 420 - 14	137	HM - 428 - 13	144
FO - 952 - 20	117	HM - 405 - 16	143	HM - 420 - 16	137	HM - 428 - 14	144
FO - 952 - 24	117	HM - 405 - 18	143	HM - 420 - 18	147	HM - 427 - 16	144
FO - 952 - 30	117	HM - 405 - 20	143	HM - 420 - 28	147	HM - 428 - 16	144
FO - 953 - 20	117	HM - 405 - 22	143	HM - 421 - 01	145	HM - 429 - 13	144
FO - 953 - 24	117	HM - 405 - 24	143	HM - 421 - 02	145	HM - 429 - 14	144
FO - 953 - 30	117	HM - 405 - 26	143	HM - 421 - 03	145	HM - 432 - 13	144
FO - 954 - 16	117	HM - 405 - 30	143	HM - 421 - 13	137	HM - 432 - 14	144

INDEX

OEM NO	PAGE	OEM NO	PAGE	OEM NO	PAGE	OEM NO	PAGE
HM - 429 - 16	144	HM - 440 - 12	139	HM - 447 - 18	140	HM - 480 - 04	135
HM - 432 - 16	144	HM - 440 - 14	139	HM - 447 - 21	140	HM - 480 - 05	135
HM - 430 - 01	149	HM - 440 - 16	149	HM - 448 - 18	140	HM - 480 - 06	135
HM - 430 - 02	149	HM - 440 - 20	149	HM - 448 - 21	140	HM - 480 - 07	135
HM - 430 - 13	138	HM - 441 - 12	139	HM - 450 - 15	140	HM - 480 - 09	135
HM - 430 - 14	138	HM - 441 - 14	139	HM - 451 - 15	140	HM - 481 - 04	135
HM - 430 - 15	138	HM - 441 - 16	149	HM - 452 - 15	140	HM - 481 - 05	135
HM - 430 - 18	138	HM - 441 - 20	149	HM - 453 - 15	140	HM - 481 - 06	135
HM - 430 - 20	138	HM - 442 - 12	139	HM - 454 - 14	140	HM - 481 - 07	135
HM - 431 - 01	149	HM - 443 - 12	139	HM - 455 - 14	140	HM - 481 - 09	135
HM - 431 - 02	149	HM - 442 - 14	139	HM - 460 - 14	141	HM - 482 - 13	136
HM - 431 - 13	138	HM - 443 - 14	139	HM - 461 - 14	141	HM - 483 - 13	136
HM - 431 - 14	138	HM - 442 - 15	149	HM - 462 - 16	141	HM - 484 - 14	136
HM - 431 - 15	138	HM - 443 - 15	149	HM - 463 - 16	141	HM - 484 - 19	136
HM - 431 - 18	138	HM - 442 - 18	149	HM - 464 - 16	141	HM - 500 - 22	151
HM - 431 - 20	138	HM - 443 - 18	149	HM - 465 - 16	141	HM - 500 - 23	151
HM - 432 - 10	138	HM - 444 - 20	150	HM - 466 - 14	141	HM - 500 - 24	151
HM - 433 - 10	138	HM - 445 - 20	150	HM - 467 - 14	141	HM - 501 - 21	151
HM - 434 - 08	138	HM - 444 - 26	150	HM - 468 - 14	141	HM - 505 - 01	152
HM - 435 - 08	138	HM - 445 - 26	150	HM - 469 - 14	141	HM - 505 - 02	152
HM - 436 - 10	139	HM - 445 - 18	140	HM - 470 - 16	141	HM - 505 - 03	152
HM - 437 - 10	139	HM - 445 - 21	140	HM - 471 - 16	141	HM - 506 - 22	152
HM - 436 - 12	139	HM - 446 - 18	140	HM - 476 - 03	135	HM - 507 - 23	152
HM - 437 - 12	139	HM - 446 - 20	150	HM - 476 - 05	135	HM - 508 - 24	152
HM - 438 - 10	139	HM - 447 - 20	150	HM - 476 - 06	135	HM - 509 - 24	152
HM - 439 - 10	139	HM - 446 - 21	140	HM - 477 - 03	135	HM - 510 - 24	152
HM - 438 - 12	139	HM - 446 - 26	150	HM - 477 - 05	135	HM - 515 - 01	153
HM - 439 - 12	139	HM - 447 - 26	150	HM - 477 - 06	135	HM - 515 - 02	153

INDEX

OEM NO	PAGE	OEM NO	PAGE	OEM NO	PAGE	OEM NO	PAGE
HM - 515 - 03	153	HM - 535 - 26	158	HM - 570 - 21	165	HM - 610 - 20	169
HM - 515 - 04	153	HM - 536 - 21	158	HM - 571 - 21	165	HM - 611 - 16	169
HM - 516 - 20	154	HM - 536 - 26	158	HM - 572 - 21	165	HM - 611 - 20	169
HM - 516 - 29	154	HM - 540 - 19	159	HM - 571 - 23	165	HM - 612 - 15	169
HM - 517 - 29	154	HM - 540 - 23	159	HM - 572 - 23	165	HM - 700 - 14	170
HM - 520 - 01	155	HM - 541 - 18	159	HM - 575 - 21	165	HM - 701 - 18	170
HM - 520 - 02	155	HM - 542 - 24	159	HM - 576 - 21	165	HM - 702 - 20	170
HM - 521 - 22	155	HM - 543 - 20	160	HM - 577 - 21	165	HM - 703 - 20	170
HM - 521 - 25	155	HM - 543 - 22	160	HM - 580 - 21	166	HM - 704 - 20	170
HM - 521 - 28	155	HM - 543 - 24	160	HM - 581 - 19	166	HM - 705 - 20	170
HM - 522 - 18	155	HM - 544 - 23	160	HM - 582 - 21	166	HM - 706 - 23	170
HM - 525 - 23	156	HM - 545 - 23	161	HM - 583 - 23	166	HM - 710 - 20	171
HM - 526 - 28	156	HM - 546 - 23	161	HM - 584 - 24	166	HM - 711 - 20	171
HM - 527 - 28	156	HM - 547 - 22	162	HM - 585 - 21	166	HM - 712 - 20	171
HM - 530 - 20	157	HM - 547 - 23	162	HM - 590 - 21	167	HM - 800 - 09	172
HM - 530 - 24	157	HM - 548 - 22	162	HM - 591 - 21	167	HM - 811 - 14	174
HM - 530 - 28	157	HM - 548 - 23	162	HM - 592 - 24	167	HM - 815 - 15	174
HM - 531 - 28	156	HM - 549 - 21	162	HM - 593 - 24	167	HM - 815 - 18	174
HM - 532 - 14	157	HM - 550 - 01	162	HM - 594 - 25	167	HM - 815 - 20	174
HM - 532 - 18	157	HM - 550 - 02	162	HM - 600 - 00	168	HM - 816 - 15	174
HM - 532 - 22	157	HM - 550 - 19	163	HM - 600 - 01	168	HM - 816 - 18	174
HM - 532 - 25	157	HM - 551 - 19	163	HM - 600 - 02	168	HM - 816 - 20	174
HM - 532 - 28	157	HM - 552 - 19	163	HM - 600 - 03	168	HM - 822 - 09	172
HM - 533 - 21	158	HM - 553 - 27	163	HM - 601 - 00	168	HM - 830 - 18	172
HM - 533 - 26	158	HM - 560 - 24	164	HM - 601 - 01	168	HM - 835 - 16	172
HM - 534 - 21	158	HM - 561 - 25	164	HM - 601 - 02	168	HM - 861 - 13	173
HM - 534 - 26	158	HM - 562 - 23	164	HM - 601 - 03	168	HM - 883 - 14	173
HM - 535 - 21	158	HM - 563 - 23	164	HM - 610 - 16	169	HO - 200 - 01	125

INDEX

OEM NO	PAGE	OEM NO	PAGE	OEM NO	PAGE	OEM NO	PAGE
HO - 200 - 02	125	HO - 304 - 10	127	HO - 464 - 16	130	HO - 504 - 15	132
HO - 201 - 15	125	HO - 310 - 04	127	HO - 470 - 01	134	HO - 505 - 15	132
HO - 202 - 13	125	HO - 310 - 06	127	HO - 470 - 02	134	HO - 506 - 17	132
HO - 203 - 01	125	HO - 310 - 10	127	HO - 470 - 03	134	KB - 101 - 08	175
HO - 203 - 02	125	HO - 315 - 16	127	HO - 470 - 16	131	KB - 102 - 06	175
HO - 203 - 03	125	HO - 316 - 16	127	HO - 470 - 16	132	KB - 103 - 02	175
HO - 204 - 03	125	HO - 400 - 16	128	HO - 471 - 01	134	KB - 104 - 07	175
HO - 204 - 04	125	HO - 401 - 16	128	HO - 471 - 02	134	KB - 105 - 02	175
HO - 205 - 16	125	HO - 402 - 16	128	HO - 471 - 03	134	KB - 106 - 03	175
HO - 206 - 01	125	HO - 403 - 16	128	HO - 471 - 16	131	KB - 107 - 02	175
HO - 206 - 02	125	HO - 404 - 16	128	HO - 472 - 01	134	KB - 111 - 06	176
HO - 207 - 01	126	HO - 405 - 16	128	HO - 472 - 01	134	KB - 111 - 08	176
HO - 207 - 02	126	HO - 406 - 16	128	HO - 472 - 16	131	KB - 112 - 01	176
HO - 208 - 01	126	HO - 407 - 16	128	HO - 473 - 01	134	KB - 112 - 02	176
HO - 208 - 02	126	HO - 408 - 16	128	HO - 473 - 02	134	KB - 113 - 01	176
HO - 209 - 13	126	HO - 450 - 16	129	HO - 473 - 03	134	KB - 200 - 01	177
HO - 210 - 05	126	HO - 451 - 16	129	HO - 473 - 16	131	KB - 200 - 02	177
HO - 210 - 07	126	HO - 452 - 16	129	HO - 474 - 01	134	KB - 200 - 03	177
HO - 211 - 10	126	HO - 453 - 16	129	HO - 474 - 02	134	KB - 200 - 04	177
HO - 211 - 12	126	HO - 454 - 16	129	HO - 474 - 03	134	KB - 200 - 05	177
HO - 212 - 11	126	HO - 455 - 16	129	HO - 474 - 16	131	KB - 200 - 45	177
HO - 300 - 16	127	HO - 456 - 16	129	HO - 475 - 01	134	KB - 200 - 65	177
HO - 301 - 16	127	HO - 457 - 16	129	HO - 475 - 02	134	KB - 201 - 01	178
HO - 302 - 16	127	HO - 458 - 16	129	HO - 475 - 16	131	KB - 201 - 02	178
HO - 303 - 16	127	HO - 460 - 16	130	HO - 480 - 00	131	KB - 201 - 03	178
HO - 304 - 04	127	HO - 461 - 16	130	HO - 501 - 16	132	KB - 201 - 04	178
HO - 304 - 06	127	HO - 462 - 16	130	HO - 502 - 15	132	KB - 201 - 05	178
HO - 304 - 08	127	HO - 463 - 16	130	HO - 503 - 15	132	KB - 201 - 06	178

INDEX

OEM NO	PAGE	OEM NO	PAGE	OEM NO	PAGE	OEM NO	PAGE
KB - 201 - 07	178	KB - 262 - 01	182	KB - 356 - 22	186	KB - 450 - 01	191
KB - 202 - 01	179	KB - 262 - 02	182	KB - 357 - 19	186	KB - 450 - 02	191
KB - 202 - 02	179	KB - 262 - 03	182	KB - 358 - 13	187	KB - 450 - 03	191
KB - 202 - 03	179	KB - 262 - 04	182	KB - 358 - 19	187	KB - 450 - 04	191
KB - 202 - 04	179	KB - 262 - 05	182	KB - 359 - 18	187	KB - 450 - 05	191
KB - 202 - 05	179	KB - 262 - 06	182	KB - 360 - 21	187	KB - 451 - 01	191
KB - 250 - 13	180	KB - 300 - 00	183	KB - 361 - 21	187	KB - 451 - 02	191
KB - 250 - 15	180	KB - 300 - 01	183	KB - 362 - 21	187	KB - 451 - 03	191
KB - 250 - 16	180	KB - 300 - 02	183	KB - 363 - 18	187	KB - 452 - 01	191
KB - 251 - 13	180	KB - 301 - 00	183	KB - 365 - 16	188	KB - 460 - 20	192
KB - 251 - 15	180	KB - 301 - 01	183	KB - 366 - 16	188	KB - 460 - 21	192
KB - 251 - 16	180	KB - 301 - 02	183	KB - 367 - 16	188	KB - 461 - 20	192
KB - 252 - 15	180	KB - 302 - 00	183	KB - 368 - 16	188	KB - 462 - 20	192
KB - 252 - 16	180	KB - 303 - 00	183	KB - 400 - 01	189	KB - 463 - 20	192
KB - 255 - 14	181	KB - 304 - 00	183	KB - 400 - 02	189	KB - 464 - 18	192
KB - 256 - 15	181	KB - 310 - 17	184	KB - 400 - 03	189	KB - 465 - 18	192
KB - 257 - 16	181	KB - 310 - 19	184	KB - 400 - 04	189	KB - 465 - 19	192
KB - 258 - 16	181	KB - 310 - 22	184	KB - 400 - 05	189	KB - 466 - 18	193
KB - 259 - 14	181	KB - 350 - 13	185	KB - 410 - 01	189	KB - 466 - 19	193
KB - 259 - 16	181	KB - 350 - 15	185	KB - 411 - 03	189	KB - 467 - 18	193
KB - 260 - 01	182	KB - 350 - 18	185	KB - 411 - 04	189	KB - 468 - 18	193
KB - 260 - 02	182	KB - 350 - 19	185	KB - 411 - 05	189	KB - 469 - 18	193
KB - 260 - 03	182	KB - 351 - 19	185	KB - 415 - 20	189	KB - 470 - 21	193
KB - 260 - 04	182	KB - 352 - 17	185	KB - 416 - 21	189	KB - 471 - 18	193
KB - 261 - 01	182	KB - 352 - 19	185	KB - 420 - 15	190	KB - 480 - 14	194
KB - 261 - 02	182	KB - 353 - 18	186	KB - 421 - 15	190	KB - 481 - 14	194
KB - 261 - 03	182	KB - 354 - 18	186	KB - 422 - 17	190	KB - 482 - 14	194
KB - 261 - 04	182	KB - 355 - 18	186	KB - 423 - 17	190	KB - 483 - 08	194

INDEX

OEM NO	PAGE	OEM NO	PAGE	OEM NO	PAGE	OEM NO	PAGE
KB - 484 - 12	194	KB - 498 - 10	196	KB - 526 - 16	199	KB - 553 - 23	203
KB - 485 - 20	194	KB - 498 - 12	196	KB - 527 - 13	199	KB - 554 - 23	203
KB - 490 - 18	195	KB - 498 - 15	196	KB - 527 - 19	199	KB - 555 - 06	203
KB - 491 - 04	195	KB - 499 - 05	196	KB - 527 - 22	199	KB - 555 - 08	203
KB - 491 - 06	195	KB - 499 - 08	196	KB - 528 - 15	199	KB - 556 - 18	203
KB - 491 - 08	195	KB - 500 - 05	196	KB - 529 - 15	199	KB - 557 - 21	203
KB - 491 - 10	195	KB - 500 - 07	196	KB - 530 - 00	200	KB - 600 - 17	204
KB - 491 - 12	195	KB - 500 - 09	196	KB - 530 - 01	200	KB - 601 - 18	204
KB - 492 - 04	195	KB - 505 - 21	197	KB - 530 - 29	201	KB - 602 - 19	204
KB - 492 - 07	195	KB - 506 - 21	197	KB - 530 - 33	201	KB - 603 - 19	204
KB - 492 - 09	195	KB - 507 - 16	197	KB - 530 - 38	201	KB - 610 - 25	205
KB - 492 - 12	195	KB - 508 - 16	197	KB - 530 - 40	201	KB - 611 - 25	205
KB - 493 - 06	195	KB - 509 - 18	197	KB - 530 - 46	201	KB - 612 - 27	205
KB - 494 - 03	195	KB - 510 - 18	197	KB - 531 - 00	200	KB - 613 - 03	205
KB - 494 - 04	195	KB - 511 - 18	197	KB - 532 - 00	200	KB - 613 - 05	205
KB - 495 - 01	195	KB - 515 - 01	198	KB - 532 - 18	201	KB - 614 - 03	205
KB - 495 - 02	195	KB - 515 - 02	198	KB - 532 - 22	201	KB - 615 - 04	205
KB - 495 - 03	195	KB - 515 - 03	198	KB - 532 - 25	201	KB - 616 - 03	205
KB - 496 - 04	196	KB - 515 - 04	198	KB - 533 - 00	200	KB - 620 - 01	206
KB - 496 - 06	196	KB - 515 - 05	198	KB - 533 - 01	200	KB - 620 - 02	206
KB - 496 - 08	196	KB - 516 - 01	198	KB - 533 - 02	200	KB - 620 - 03	206
KB - 497 - 10	196	KB - 516 - 02	198	KB - 540 - 00	202	KB - 620 - 04	206
KB - 497 - 12	196	KB - 516 - 03	198	KB - 541 - 20	202	KB - 620 - 05	206
KB - 497 - 14	196	KB - 517 - 08	198	KB - 542 - 20	202	KB - 620 - 06	206
KB - 497 - 16	196	KB - 518 - 08	198	KB - 543 - 20	202	KB - 621 - 01	206
KB - 498 - 04	196	KB - 519 - 08	198	KB - 550 - 23	203	KB - 621 - 02	206
KB - 498 - 06	196	KB - 520 - 08	198	KB - 551 - 21	203	KB - 621 - 03	206
KB - 498 - 08	196	KB - 525 - 15	199	KB - 552 - 21	203	KB - 621 - 04	206

INDEX

OEM NO	PAGE	OEM NO	PAGE	OEM NO	PAGE	OEM NO	PAGE
KB - 621 - 05	206	KB - 640 - 02	210	KL - 201 - 15	213	KL - 250 - 25	214
KB - 621 - 06	206	KB - 640 - 03	210	KL - 201 - 20	213	KL - 250 - 30	214
KB - 622 - 01	207	KB - 640 - 04	210	KL - 201 - 25	213	KL - 250 - 38	214
KB - 622 - 02	207	KB - 640 - 05	210	KL - 202 - 10	213	KL - 250 - 44	214
KB - 622 - 03	207	KB - 640 - 06	210	KL - 202 - 15	213	KL - 250 - 50	214
KB - 622 - 04	207	KB - 640 - 07	210	KL - 203 - 08	213	KL - 251 - 08	214
KB - 623 - 01	207	KB - 640 - 08	210	KL - 203 - 10	213	KL - 251 - 13	214
KB - 623 - 02	207	KB - 640 - 09	211	KL - 203 - 12	213	KL - 251 - 18	214
KB - 623 - 03	207	KB - 640 - 10	211	KL - 203 - 15	213	KL - 251 - 20	214
KB - 624 - 01	207	KB - 640 - 11	211	KL - 203 - 20	213	KL - 251 - 25	214
KB - 624 - 02	207	KB - 640 - 12	211	KL - 203 - 25	213	KL - 251 - 30	214
KB - 624 - 03	207	KB - 641 - 00	211	KL - 204 - 10	213	KL - 252 - 11	214
KB - 625 - 01	208	KB - 641 - 02	211	KL - 204 - 12	213	KL - 253 - 08	214
KB - 625 - 02	208	KB - 641 - 03	211	KL - 204 - 15	213	KL - 253 - 10	214
KB - 625 - 03	208	KB - 700 - 12	212	KL - 204 - 20	213	MA - 100 - 10	215
KB - 626 - 01	208	KB - 701 - 12	212	KL - 204 - 25	213	MA - 100 - 11	215
KB - 626 - 02	208	KB - 701 - 13	212	KL - 205 - 10	213	MA - 100 - 13	215
KB - 627 - 24	208	KB - 702 - 16	212	KL - 205 - 12	213	MA - 100 - 14	215
KB - 630 - 00	209	KB - 900 - 18	190	KL - 205 - 15	213	MA - 100 - 15	215
KB - 631 - 01	209	KB - 901 - 18	190	KL - 205 - 20	213	MA - 100 - 16	215
KB - 631 - 02	209	KB - 902 - 18	190	KL - 205 - 25	213	MA - 100 - 17	215
KB - 631 - 03	209	KL - 200 - 10	213	KL - 250 - 04	214	MA - 100 - 18	215
KB - 631 - 04	209	KL - 200 - 12	213	KL - 250 - 08	214	MA - 100 - 20	215
KB - 631 - 10	209	KL - 200 - 15	213	KL - 250 - 10	214	MA - 101 - 10	215
KB - 631 - 11	209	KL - 200 - 20	213	KL - 250 - 13	214	MA - 101 - 11	215
KB - 634 - 00	209	KL - 200 - 25	213	KL - 250 - 15	214	MA - 101 - 13	215
KB - 640 - 00	210	KL - 201 - 10	213	KL - 250 - 18	214	MA - 101 - 14	215
KB - 640 - 01	210	KL - 201 - 12	213	KL - 250 - 20	214	MA - 101 - 15	215

INDEX

OEM NO	PAGE	OEM NO	PAGE	OEM NO	PAGE	OEM NO	PAGE
MA - 101 - 16	215	MA - 104 - 17	215	MA - 115 - 16	217	MA - 133 - 18	219
MA - 101 - 17	215	MA - 104 - 18	215	MA - 115 - 18	217	MA - 134 - 16	219
MA - 101 - 18	215	MA - 104 - 20	215	MA - 116 - 14	217	MA - 135 - 16	219
MA - 101 - 20	215	MA - 105 - 10	215	MA - 117 - 14	217	MA - 134 - 18	219
MA - 102 - 10	215	MA - 105 - 11	215	MA - 118 - 15	217	MA - 135 - 18	219
MA - 102 - 11	215	MA - 105 - 13	215	MA - 119 - 15	217	MA - 141 - 20	220
MA - 102 - 13	215	MA - 105 - 14	215	MA - 120 - 17	218	MA - 141 - 23	220
MA - 102 - 14	215	MA - 105 - 15	215	MA - 121 - 17	218	MA - 142 - 20	220
MA - 102 - 15	215	MA - 105 - 16	215	MA - 125 - 14	218	MA - 142 - 23	220
MA - 102 - 16	215	MA - 105 - 17	215	MA - 125 - 17	218	MA - 143 - 20	220
MA - 102 - 17	215	MA - 105 - 18	215	MA - 125 - 23	218	MA - 143 - 23	220
MA - 102 - 18	215	MA - 105 - 20	215	MA - 125 - 28	218	MA - 144 - 20	220
MA - 102 - 20	215	MA - 106 - 13	216	MA - 126 - 14	218	MA - 144 - 23	220
MA - 103 - 10	215	MA - 106 - 14	216	MA - 126 - 17	218	MA - 145 - 20	220
MA - 103 - 11	215	MA - 107 - 13	216	MA - 126 - 23	218	MA - 145 - 23	220
MA - 103 - 13	215	MA - 107 - 14	216	MA - 126 - 28	218	MA - 146 - 27	220
MA - 103 - 14	215	MA - 108 - 13	216	MA - 127 - 15	218	MA - 147 - 27	220
MA - 103 - 15	215	MA - 108 - 14	216	MA - 127 - 17	218	MA - 148 - 24	220
MA - 103 - 16	215	MA - 109 - 13	216	MA - 127 - 19	218	MA - 149 - 14	221
MA - 103 - 17	215	MA - 109 - 14	216	MA - 127 - 21	218	MA - 150 - 14	221
MA - 103 - 18	215	MA - 110 - 13	216	MA - 128 - 15	218	MA - 151 - 14	221
MA - 103 - 20	215	MA - 110 - 14	216	MA - 128 - 17	218	MA - 152 - 14	221
MA - 104 - 10	215	MA - 111 - 13	216	MA - 128 - 19	218	MA - 153 - 14	221
MA - 104 - 11	215	MA - 111 - 14	216	MA - 128 - 21	218	MA - 154 - 14	221
MA - 104 - 13	215	MA - 112 - 13	217	MA - 129 - 16	219	MA - 155 - 11	221
MA - 104 - 14	215	MA - 112 - 14	217	MA - 130 - 16	219	MA - 156 - 11	221
MA - 104 - 15	215	MA - 113 - 15	217	MA - 131 - 16	219	MA - 200 - 18	222
MA - 104 - 16	215	MA - 114 - 14	217	MA - 132 - 18	219	MA - 200 - 20	222

INDEX

OEM NO	PAGE	OEM NO	PAGE	OEM NO	PAGE	OEM NO	PAGE
MA - 200 - 23	222	MA - 205 - 18	222	MA - 217 - 18	223	MA - 233 - 15	225
MA - 200 - 25	222	MA - 205 - 20	222	MA - 217 - 20	223	MA - 233 - 18	225
MA - 200 - 28	222	MA - 205 - 23	222	MA - 217 - 23	223	MA - 234 - 25	226
MA - 200 - 30	222	MA - 205 - 25	222	MA - 217 - 25	223	MA - 234 - 45	226
MA - 201 - 18	222	MA - 205 - 28	222	MA - 217 - 28	223	MA - 234 - 60	226
MA - 201 - 20	222	MA - 205 - 30	222	MA - 217 - 30	223	MA - 235 - 16	226
MA - 201 - 23	222	MA - 210 - 14	223	MA - 218 - 15	224	MA - 235 - 19	226
MA - 201 - 25	222	MA - 211 - 14	223	MA - 219 - 15	224	MA - 235 - 23	226
MA - 201 - 28	222	MA - 212 - 14	223	MA - 220 - 16	224	MA - 235 - 28	226
MA - 201 - 30	222	MA - 213 - 14	223	MA - 221 - 16	224	MA - 236 - 16	226
MA - 202 - 18	222	MA - 214 - 18	223	MA - 222 - 13	224	MA - 236 - 19	226
MA - 202 - 20	222	MA - 214 - 20	223	MA - 223 - 19	224	MA - 236 - 23	226
MA - 202 - 23	222	MA - 214 - 23	223	MA - 224 - 10	224	MA - 236 - 28	226
MA - 202 - 25	222	MA - 214 - 25	223	MA - 225 - 10	224	MA - 237 - 16	226
MA - 202 - 28	222	MA - 214 - 28	223	MA - 226 - 14	225	MA - 237 - 19	226
MA - 202 - 30	222	MA - 214 - 30	223	MA - 227 - 14	225	MA - 237 - 23	226
MA - 203 - 18	222	MA - 215 - 18	223	MA - 228 - 14	225	MA - 237 - 28	226
MA - 203 - 20	222	MA - 215 - 20	223	MA - 229 - 14	225	MA - 238 - 01	227
MA - 203 - 23	222	MA - 215 - 23	223	MA - 230 - 12	225	MA - 238 - 02	227
MA - 203 - 25	222	MA - 215 - 25	223	MA - 231 - 12	225	MA - 238 - 03	227
MA - 203 - 28	222	MA - 215 - 28	223	MA - 230 - 15	225	MA - 238 - 05	227
MA - 203 - 30	222	MA - 215 - 30	223	MA - 231 - 15	225	MA - 239 - 01	227
MA - 204 - 18	222	MA - 216 - 18	223	MA - 230 - 18	225	MA - 239 - 02	227
MA - 204 - 20	222	MA - 216 - 20	223	MA - 231 - 18	225	MA - 239 - 03	227
MA - 204 - 23	222	MA - 216 - 23	223	MA - 230 - 20	225	MA - 239 - 04	227
MA - 204 - 25	222	MA - 216 - 25	223	MA - 231 - 20	225	MA - 239 - 05	227
MA - 204 - 28	222	MA - 216 - 28	223	MA - 232 - 15	225	MA - 240 - 19	227
MA - 204 - 30	222	MA - 216 - 30	223	MA - 232 - 18	225	MA - 241 - 19	228

INDEX

OEM NO	PAGE	OEM NO	PAGE	OEM NO	PAGE	OEM NO	PAGE
MA - 242 - 11	228	MA - 316 - 21	231	MA - 460 - 02	235	MA - 557 - 02	238
MA - 243 - 14	228	MA - 317 - 21	231	MA - 460 - 03	235	MA - 557 - 12	237
MA - 244 - 14	228	MA - 320 - 11	231	MA - 461 - 01	235	MA - 558 - 01	238
MA - 245 - 22	228	MA - 321 - 11	231	MA - 461 - 02	235	MA - 558 - 02	238
MA - 246 - 22	228	MA - 320 - 13	231	MA - 461 - 03	235	MA - 559 - 11	238
MA - 247 - 17	228	MA - 321 - 13	231	MA - 462 - 11	235	MA - 560 - 11	238
MA - 248 - 15	228	MA - 320 - 14	231	MA - 463 - 11	235	MA - 561 - 09	238
MA - 250 - 15	229	MA - 321 - 14	231	MA - 540 - 11	236	MA - 561 - 10	238
MA - 251 - 15	229	MA - 440 - 17	232	MA - 541 - 11	236	MA - 561 - 11	238
MA - 252 - 21	229	MA - 441 - 18	232	MA - 542 - 11	236	MA - 562 - 09	238
MA - 253 - 21	229	MA - 442 - 19	232	MA - 542 - 14	236	MA - 562 - 10	238
MA - 255 - 17	229	MA - 443 - 19	232	MA - 543 - 14	236	MA - 562 - 11	238
MA - 256 - 18	229	MA - 444 - 15	232	MA - 544 - 14	236	MA - 565 - 11	239
MA - 257 - 18	229	MA - 445 - 22	232	MA - 545 - 13	236	MA - 566 - 11	239
MA - 301 - 23	230	MA - 446 - 22	232	MA - 546 - 13	236	MA - 567 - 11	239
MA - 302 - 24	230	MA - 447 - 13	232	MA - 547 - 10	236	MA - 569 - 10	239
MA - 304 - 17	230	MA - 448 - 13	232	MA - 548 - 10	236	MA - 570 - 10	239
MA - 305 - 17	230	MA - 450 - 16	233	MA - 547 - 11	236	MA - 571 - 11	239
MA - 306 - 17	230	MA - 451 - 18	233	MA - 548 - 11	236	MA - 572 - 11	239
MA - 307 - 17	230	MA - 452 - 19	233	MA - 549 - 11	236	MA - 573 - 10	239
MA - 308 - 17	230	MA - 453 - 14	234	MA - 550 - 09	237	MA - 573 - 11	239
MA - 309 - 23	230	MA - 453 - 18	234	MA - 551 - 10	237	MA - 574 - 10	239
MA - 310 - 20	231	MA - 453 - 22	234	MA - 552 - 08	237	MA - 574 - 11	239
MA - 311 - 19	231	MA - 454 - 20	234	MA - 553 - 08	237	MA - 575 - 10	239
MA - 312 - 19	231	MA - 455 - 15	234	MA - 554 - 12	237	MA - 575 - 11	239
MA - 313 - 30	231	MA - 456 - 10	234	MA - 555 - 12	237	MA - 576 - 10	239
MA - 314 - 27	231	MA - 457 - 16	234	MA - 556 - 12	237	MA - 576 - 11	239
MA - 315 - 21	231	MA - 460 - 01	235	MA - 557 - 01	238	MA - 577 - 10	240

INDEX

OEM NO	PAGE	OEM NO	PAGE	OEM NO	PAGE	OEM NO	PAGE
MA - 578 - 10	240	MA - 608 - 10	243	MA - 704 - 09	248	MA - 850 - 18	261
MA - 579 - 10	240	MA - 609 - 10	243	MA - 704 - 10	248	MA - 851 - 14	261
MA - 580 - 10	240	MA - 610 - 12	244	MA - 705 - 10	248	MA - 851 - 16	261
MA - 581 - 10	240	MA - 611 - 12	244	MA - 705 - 11	248	MA - 851 - 18	261
MA - 582 - 10	240	MA - 612 - 10	244	MA - 706 - 10	248	MA - 852 - 14	261
MA - 583 - 09	240	MA - 613 - 09	244	MA - 706 - 11	248	MA - 852 - 16	261
MA - 584 - 09	240	MA - 614 - 09	244	MA - 707 - 11	248	MA - 852 - 18	261
MA - 585 - 09	240	MA - 615 - 11	244	MA - 708 - 11	248	MA - 853 - 14	261
MA - 586 - 09	240	MA - 616 - 11	244	MA - 709 - 13	248	MA - 853 - 16	261
MA - 587 - 09	240	MA - 617 - 14	245	MA - 709 - 15	248	MA - 853 - 18	261
MA - 588 - 09	240	MA - 618 - 16	245	MA - 710 - 13	249	MA - 854 - 14	262
MA - 590 - 11	241	MA - 619 - 18	245	MA - 711 - 13	249	MA - 854 - 16	262
MA - 591 - 14	241	MA - 620 - 23	245	MA - 712 - 13	249	MA - 854 - 18	262
MA - 592 - 16	241	MA - 621 - 18	245	MA - 713 - 11	249	MA - 855 - 14	262
MA - 593 - 12	241	MA - 622 - 17	245	MA - 714 - 16	249	MA - 855 - 16	262
MA - 594 - 12	241	MA - 631 - 23	246	MA - 715 - 16	249	MA - 855 - 18	262
MA - 595 - 11	241	MA - 632 - 14	246	MA - 716 - 16	249	MA - 856 - 14	262
MA - 596 - 15	242	MA - 633 - 14	246	MA - 717 - 17	249	MA - 856 - 17	262
MA - 597 - 12	242	MA - 638 - 23	247	MA - 718 - 17	249	MA - 856 - 23	262
MA - 598 - 09	242	MA - 639 - 20	247	MA - 719 - 12	250	MA - 857 - 14	262
MA - 599 - 12	242	MA - 640 - 24	247	MA - 720 - 12	250	MA - 857 - 17	262
MA - 601 - 12	243	MA - 641 - 24	247	MA - 721 - 11	250	MA - 857 - 23	262
MA - 602 - 10	243	MA - 701 - 09	248	MA - 722 - 11	250	MA - 858 - 01	263
MA - 603 - 11	243	MA - 701 - 10	248	MA - 723 - 14	250	MA - 858 - 02	263
MA - 604 - 12	243	MA - 702 - 09	248	MA - 724 - 14	250	MA - 859 - 15	263
MA - 605 - 17	243	MA - 702 - 10	248	MA - 725 - 12	250	MA - 859 - 17	263
MA - 606 - 10	243	MA - 703 - 09	248	MA - 850 - 14	261	MA - 860 - 15	263
MA - 607 - 10	243	MA - 703 - 10	248	MA - 850 - 16	261	MA - 860 - 17	263

INDEX

OEM NO	PAGE	OEM NO	PAGE	OEM NO	PAGE	OEM NO	PAGE
MA - 861 - 23	264	MA - 875 - 14	267	MA - 887 - 11	270	MA - 924 - 01	254
MA - 862 - 23	264	MA - 876 - 14	267	MA - 889 - 12	270	MA - 924 - 02	254
MA - 863 - 20	264	MA - 877 - 14	267	MA - 890 - 18	270	MA - 925 - 01	254
MA - 864 - 28	264	MA - 878 - 14	267	MA - 906 - 11	251	MA - 925 - 02	254
MA - 865 - 11	264	MA - 879 - 18	268	MA - 907 - 11	251	MA - 926 - 01	254
MA - 866 - 11	264	MA - 879 - 20	268	MA - 908 - 11	251	MA - 926 - 02	254
MA - 867 - 14	264	MA - 879 - 23	268	MA - 910 - 02	251	MA - 927 - 12	255
MA - 868 - 14	264	MA - 879 - 25	268	MA - 910 - 03	251	MA - 928 - 15	255
MA - 869 - 18	265	MA - 879 - 28	268	MA - 911 - 09	251	MA - 929 - 01	255
MA - 869 - 20	265	MA - 880 - 18	268	MA - 912 - 09	251	MA - 929 - 02	255
MA - 869 - 23	265	MA - 880 - 20	268	MA - 915 - 01	251	MA - 950 - 15	256
MA - 869 - 25	265	MA - 880 - 23	268	MA - 916 - 01	253	MA - 950 - 18	256
MA - 869 - 28	265	MA - 880 - 25	268	MA - 916 - 01	252	MA - 951 - 15	256
MA - 869 - 30	265	MA - 880 - 28	268	MA - 916 - 02	253	MA - 951 - 18	256
MA - 870 - 18	265	MA - 881 - 18	269	MA - 916 - 03	252	MA - 952 - 14	257
MA - 870 - 20	265	MA - 881 - 20	269	MA - 916 - 03	253	MA - 953 - 18	257
MA - 870 - 23	265	MA - 881 - 23	269	MA - 916 - 04	253	MA - 954 - 18	257
MA - 870 - 25	265	MA - 881 - 25	269	MA - 916 - 04	252	MA - 955 - 11	258
MA - 870 - 28	265	MA - 881 - 28	269	MA - 917 - 01	252	MA - 956 - 15	258
MA - 870 - 30	265	MA - 882 - 18	269	MA - 917 - 01	253	MA - 957 - 15	258
MA - 871 - 25	266	MA - 882 - 20	269	MA - 917 - 02	252	MA - 958 - 15	258
MA - 871 - 45	266	MA - 882 - 23	269	MA - 917 - 02	253	MA - 959 - 15	258
MA - 871 - 60	266	MA - 882 - 25	269	MA - 917 - 03	252	MA - 960 - 15	258
MA - 872 - 25	266	MA - 882 - 28	269	MA - 917 - 03	253	MA - 961 - 15	258
MA - 872 - 45	266	MA - 883 - 17	270	MA - 917 - 04	252	MA - 962 - 15	258
MA - 872 - 60	266	MA - 884 - 13	270	MA - 917 - 04	253	MA - 963 - 19	259
MA - 873 - 16	267	MA - 885 - 13	270	MA - 923 - 01	254	MA - 964 - 19	259
MA - 874 - 16	267	MA - 886 - 11	270	MA - 923 - 02	254	MA - 965 - 16	259

INDEX

OEM NO	PAGE	OEM NO	PAGE	OEM NO	PAGE	OEM NO	PAGE
MA - 965 - 20	259	OF - 207 - 14	291	OF - 931 - 08	295	OG - 111 - 18	272
MA - 965 - 22	259	OF - 208 - 22	291	OF - 931 - 09	295	OG - 111 - 19	272
MA - 966 - 16	259	OF - 210 - 32	291	OF - 931 - 10	295	OG - 111 - 21	272
MA - 966 - 20	259	OF - 211 - 17	292	OF - 931 - 11	295	OG - 111 - 23	272
MA - 966 - 22	259	OF - 212 - 24	292	OF - 931 - 12	295	OG - 200 - 34	273
MA - 967 - 16	259	OF - 213 - 18	292	OG - 100 - 24	271	OG - 200 - 29	273
MA - 967 - 20	259	OF - 214 - 17	292	OG - 101 - 24	271	OG - 201 - 23	273
MA - 967 - 22	259	OF - 215 - 23	293	OG - 110 - 04	272	OG - 201 - 28	273
MA - 968 - 16	259	OF - 216 - 23	293	OG - 110 - 04	272	OG - 202 - 23	273
MA - 968 - 20	259	OF - 400 - 14	294	OG - 110 - 23	272	OG - 202 - 26	273
MA - 968 - 22	259	OF - 401 - 14	294	OG - 110 - 07	272	OG - 202 - 28	273
MA - 969 - 01	260	OF - 450 - 17	294	OG - 110 - 08	272	OG - 250 - 01	274
MA - 969 - 02	260	OF - 450 - 17	294	OG - 110 - 10	272	OG - 250 - 02	274
MA - 969 - 03	260	OF - 451 - 17	294	OG - 110 - 12	272	OG - 250 - 03	274
MA - 969 - 04	260	OF - 451 - 17	294	OG - 110 - 14	272	OG - 251 - 01	274
MA - 969 - 05	260	OF - 452 - 19	294	OG - 110 - 15	272	OG - 251 - 02	274
MA - 970 - 01	260	OF - 900 - 16	295	OG - 110 - 16	272	OG - 251 - 03	274
MA - 970 - 02	260	OF - 910 - 26	295	OG - 110 - 18	272	OG - 251 - 04	274
MA - 970 - 03	260	OF - 920 - 00	295	OG - 110 - 19	272	OG - 252 - 01	274
MA - 970 - 04	260	OF - 930 - 04	295	OG - 110 - 21	272	OG - 252 - 02	274
MA - 970 - 05	260	OF - 930 - 08	295	OG - 110 - 23	272	OG - 252 - 03	274
OF - 200 - 27	289	OF - 930 - 10	295	OG - 111 - 07	272	OG - 253 - 01	274
OF - 201 - 23	289	OF - 931 - 02	295	OG - 111 - 08	272	OG - 253 - 02	274
OF - 202 - 29	289	OF - 931 - 03	295	OG - 111 - 10	272	OG - 253 - 03	274
OF - 203 - 18	289	OF - 931 - 04	295	OG - 111 - 12	272	OG - 253 - 04	274
OF - 203 - 24	289	OF - 931 - 05	295	OG - 111 - 14	272	OG - 254 - 01	274
OF - 205 - 47	290	OF - 931 - 06	295	OG - 111 - 15	272	OG - 254 - 02	274
OF - 206 - 14	291	OF - 931 - 07	295	OG - 111 - 16	272	OG - 254 - 03	274

INDEX

OEM NO	PAGE	OEM NO	PAGE	OEM NO	PAGE	OEM NO	PAGE
OG - 254 - 04	274	OG - 261 - 04	275	OG - 300 - 19	281	OM - 312 - 17	283
OG - 254 - 05	274	OG - 262 - 01	275	OG - 300 - 24	281	OM - 313 - 00	283
OG - 255 - 01	274	OG - 262 - 02	275	OG - 300 - 26	281	OM - 350 - 23	284
OG - 255 - 02	274	OG - 262 - 03	275	OG - 300 - 28	281	OM - 351 - 23	284
OG - 255 - 03	274	OG - 265 - 22	276	OG - 301 - 17	281	OM - 352 - 24	284
OG - 255 - 04	274	OG - 266 - 01	276	OG - 302 - 01	281	OM - 353 - 23	285
OG - 255 - 05	274	OG - 266 - 02	276	OG - 302 - 02	281	OM - 354 - 24	285
OG - 256 - 01	274	OG - 266 - 03	276	OG - 302 - 03	281	OM - 355 - 24	285
OG - 256 - 02	274	OG - 267 - 01	276	OG - 310 - 20	283	OM - 360 - 14	286
OG - 257 - 01	275	OG - 267 - 02	276	OM - 200 - 37	278	OM - 360 - 17	286
OG - 257 - 02	275	OG - 267 - 03	276	OM - 201 - 34	278	OM - 360 - 20	286
OG - 257 - 03	275	OG - 267 - 04	276	OM - 202 - 25	278	OM - 360 - 22	286
OG - 257 - 04	275	OG - 267 - 05	276	OM - 210 - 19	279	OM - 361 - 17	286
OG - 257 - 05	275	OG - 267 - 06	276	OM - 211 - 19	279	OM - 361 - 22	286
OG - 258 - 01	275	OG - 268 - 01	276	OM - 212 - 26	279	OM - 361 - 20	286
OG - 258 - 02	275	OG - 268 - 02	276	OM - 213 - 25	279	OM - 365 - 24	287
OG - 258 - 03	275	OG - 268 - 03	276	OM - 214 - 24	280	OM - 366 - 28	287
OG - 259 - 01	275	OG - 269 - 01	276	OM - 215 - 31	280	OM - 367 - 28	287
OG - 259 - 02	275	OG - 269 - 02	276	OM - 216 - 31	280	OM - 368 - 26	288
OG - 259 - 03	275	OG - 269 - 03	276	OM - 217 - 19	280	OM - 369 - 25	288
OG - 259 - 04	275	OG - 270 - 01	276	OM - 305 - 26	282	OP - 200 - 12	297
OG - 260 - 01	275	OG - 270 - 02	276	OM - 306 - 22	282	PO - 100 - 10	321
OG - 260 - 02	275	OG - 270 - 03	276	OM - 306 - 26	282	PO - 101 - 10	321
OG - 260 - 03	275	OG - 275 - 01	277	OM - 306 - 33	282	PO - 102 - 10	321
OG - 260 - 04	275	OG - 275 - 02	277	OM - 307 - 21	282	PO - 103 - 10	321
OG - 261 - 01	275	OG - 275 - 03	277	OM - 308 - 27	282	PO - 104 - 11	321
OG - 261 - 02	275	OG - 275 - 04	277	OM - 310 - 17	283	PO - 104 - 13	321
OG - 261 - 03	275	OG - 300 - 14	281	OM - 311 - 21	283	PO - 104 - 14	321

INDEX

OEM NO	PAGE	OEM NO	PAGE	OEM NO	PAGE	OEM NO	PAGE
PO - 105 - 14	321	PO - 132 - 14	325	PO - 149 - 02	328	PO - 170 - 27	330
PO - 106 - 14	321	PO - 133 - 14	325	PO - 150 - 01	328	PO - 171 - 21	330
PO - 107 - 01	322	PO - 134 - 14	325	PO - 150 - 02	328	PO - 171 - 27	330
PO - 107 - 02	322	PO - 135 - 18	325	PO - 151 - 01	329	PO - 180 - 20	331
PO - 108 - 15	322	PO - 135 - 21	325	PO - 151 - 02	329	PO - 181 - 19	331
PO - 109 - 15	322	PO - 136 - 16	326	PO - 151 - 03	329	PO - 181 - 20	331
PO - 110 - 15	322	PO - 136 - 18	326	PO - 151 - 04	329	PO - 182 - 01	331
PO - 111 - 15	322	PO - 136 - 20	326	PO - 152 - 01	329	PO - 182 - 02	331
PO - 112 - 14	323	PO - 136 - 22	326	PO - 152 - 02	329	PO - 182 - 03	331
PO - 113 - 14	323	PO - 137 - 16	326	PO - 152 - 03	329	PO - 183 - 01	331
PO - 114 - 14	323	PO - 137 - 18	326	PO - 152 - 04	329	PO - 183 - 02	331
PO - 115 - 18	324	PO - 137 - 20	326	PO - 153 - 01	329	PO - 184 - 25	332
PO - 116 - 18	324	PO - 137 - 22	326	PO - 153 - 02	329	PO - 185 - 21	332
PO - 117 - 18	324	PO - 138 - 11	327	PO - 153 - 03	329	PO - 186 - 01	332
PO - 118 - 18	324	PO - 139 - 11	327	PO - 153 - 04	329	PO - 186 - 02	332
PO - 119 - 09	325	PO - 140 - 14	327	PO - 160 - 20	330	PO - 187 - 15	332
PO - 120 - 09	325	PO - 141 - 14	327	PO - 161 - 20	330	PO - 188 - 14	332
PO - 121 - 09	325	PO - 142 - 14	327	PO - 162 - 20	330	PO - 189 - 01	333
PO - 122 - 09	325	PO - 143 - 14	327	PO - 163 - 20	330	PO - 189 - 02	333
PO - 123 - 14	325	PO - 144 - 14	327	PO - 164 - 21	330	PO - 190 - 23	333
PO - 124 - 14	325	PO - 145 - 13	327	PO - 164 - 27	330	PO - 191 - 23	333
PO - 125 - 14	325	PO - 145 - 15	327	PO - 165 - 21	330	PO - 192 - 01	333
PO - 126 - 14	325	PO - 146 - 22	327	PO - 165 - 27	330	PO - 192 - 02	333
PO - 127 - 14	325	PO - 147 - 01	328	PO - 166 - 20	330	PO - 193 - 01	334
PO - 128 - 14	325	PO - 147 - 02	328	PO - 167 - 20	330	PO - 193 - 02	334
PO - 129 - 14	325	PO - 148 - 01	328	PO - 168 - 20	330	PO - 194 - 01	334
PO - 130 - 14	325	PO - 148 - 02	328	PO - 169 - 20	330	PO - 194 - 02	334
PO - 131 - 14	325	PO - 149 - 01	328	PO - 170 - 21	330	PO - 195 - 21	334

INDEX

OEM NO	PAGE	OEM NO	PAGE	OEM NO	PAGE	OEM NO	PAGE
PO - 196 - 01	334	PO - 211 - 27	337	PO - 224 - 10	340	PO - 237 - 23	302
PO - 196 - 02	334	PO - 212 - 12	297	PO - 224 - 18	300	PO - 239 - 14	302
PO - 197 - 23	334	PO - 212 - 27	337	PO - 224 - 26	300	PO - 239 - 17	302
PO - 198 - 01	335	PO - 213 - 12	297	PO - 225 - 01	340	PO - 239 - 19	302
PO - 198 - 02	335	PO - 213 - 18	337	PO - 225 - 02	340	PO - 240 - 16	302
PO - 198 - 03	335	PO - 214 - 13	298	PO - 225 - 13	300	PO - 241 - 14	303
PO - 198 - 04	335	PO - 214 - 23	338	PO - 225 - 18	300	PO - 241 - 17	303
PO - 199 - 25	335	PO - 215 - 13	298	PO - 226 - 18	300	PO - 241 - 20	303
PO - 200 - 22	336	PO - 215 - 21	338	PO - 227 - 15	300	PO - 241 - 24	303
PO - 201 - 16	297	PO - 216 - 13	298	PO - 227 - 17	300	PO - 242 - 14	303
PO - 201 - 22	336	PO - 216 - 23	338	PO - 228 - 17	300	PO - 242 - 17	303
PO - 202 - 16	297	PO - 217 - 13	298	PO - 229 - 18	300	PO - 243 - 17	303
PO - 202 - 19	336	PO - 217 - 16	338	PO - 230 - 14	301	PO - 243 - 20	303
PO - 203 - 19	336	PO - 218 - 12	339	PO - 230 - 16	301	PO - 243 - 24	303
PO - 204 - 01	336	PO - 218 - 13	298	PO - 230 - 18	301	PO - 244 - 20	304
PO - 204 - 02	336	PO - 219 - 13	339	PO - 230 - 20	301	PO - 244 - 25	304
PO - 204 - 03	336	PO - 219 - 15	299	PO - 230 - 24	301	PO - 245 - 18	304
PO - 205 - 25	337	PO - 219 - 18	299	PO - 230 - 26	301	PO - 246 - 20	304
PO - 206 - 28	337	PO - 220 - 14	339	PO - 230 - 30	301	PO - 246 - 23	304
PO - 207 - 15	337	PO - 220 - 15	299	PO - 231 - 16	301	PO - 247 - 15	304
PO - 207 - 16	337	PO - 221 - 12	339	PO - 231 - 18	301	PO - 248 - 18	305
PO - 208 - 15	337	PO - 221 - 15	299	PO - 231 - 20	301	PO - 249 - 16	305
PO - 208 - 16	337	PO - 222 - 12	339	PO - 232 - 21	301	PO - 249 - 18	305
PO - 209 - 18	337	PO - 222 - 18	299	PO - 233 - 23	301	PO - 249 - 20	305
PO - 210 - 12	297	PO - 223 - 12	339	PO - 234 - 27	301	PO - 250 - 25	305
PO - 210 - 24	337	PO - 223 - 20	299	PO - 235 - 27	302	PO - 280 - 20	306
PO - 211 - 12	297	PO - 223 - 24	299	PO - 236 - 27	302	PO - 280 - 24	306
PO - 211 - 18	337	PO - 223 - 26	299	PO - 237 - 20	302	PO - 281 - 01	306

INDEX

OEM NO	PAGE	OEM NO	PAGE	OEM NO	PAGE	OEM NO	PAGE
PO - 281 - 02	306	PO - 904 - 20	308	PO - 923 - 20	312	PO - 935 - 16	315
PO - 281 - 03	306	PO - 904 - 23	308	PO - 923 - 24	312	PO - 936 - 25	315
PO - 900 - 14	307	PO - 905 - 14	308	PO - 923 - 30	312	PO - 937 - 18	315
PO - 900 - 16	307	PO - 905 - 18	308	PO - 924 - 14	312	PO - 938 - 20	315
PO - 900 - 18	307	PO - 905 - 20	308	PO - 924 - 17	312	PO - 939 - 20	316
PO - 900 - 20	307	PO - 905 - 23	308	PO - 924 - 19	312	PO - 939 - 23	316
PO - 900 - 24	307	PO - 906 - 15	309	PO - 925 - 16	312	PO - 940 - 18	316
PO - 900 - 26	307	PO - 907 - 18	309	PO - 926 - 14	313	PO - 941 - 20	316
PO - 900 - 30	307	PO - 908 - 18	309	PO - 926 - 17	313	PO - 942 - 16	316
PO - 901 - 18	307	PO - 909 - 15	309	PO - 926 - 20	313	PO - 942 - 18	316
PO - 901 - 20	307	PO - 909 - 17	309	PO - 926 - 24	313	PO - 942 - 20	316
PO - 901 - 23	307	PO - 910 - 12	310	PO - 927 - 17	313	PO - 943 - 18	316
PO - 901 - 26	307	PO - 911 - 12	310	PO - 927 - 20	313	PO - 943 - 20	316
PO - 901 - 31	307	PO - 912 - 13	310	PO - 927 - 23	313	PO - 943 - 23	316
PO - 902 - 13	308	PO - 913 - 13	310	PO - 928 - 14	313	PO - 944 - 18	316
PO - 902 - 15	308	PO - 914 - 13	310	PO - 928 - 17	313	PO - 944 - 20	316
PO - 902 - 18	308	PO - 915 - 13	310	PO - 928 - 20	313	PO - 944 - 23	316
PO - 902 - 20	308	PO - 915 - 13	310	PO - 929 - 17	313	PO - 945 - 13	317
PO - 902 - 23	308	PO - 916 - 13	310	PO - 929 - 19	313	PO - 945 - 18	317
PO - 902 - 26	308	PO - 916 - 13	310	PO - 930 - 17	314	PO - 946 - 01	317
PO - 903 - 13	308	PO - 917 - 15	311	PO - 930 - 20	314	PO - 946 - 02	317
PO - 903 - 15	308	PO - 918 - 15	311	PO - 930 - 24	314	PO - 947 - 18	317
PO - 903 - 18	308	PO - 919 - 15	311	PO - 931 - 17	314	PO - 948 - 01	317
PO - 903 - 20	308	PO - 920 - 18	311	PO - 931 - 20	314	PO - 948 - 02	317
PO - 903 - 23	308	PO - 920 - 20	311	PO - 931 - 24	314	PO - 948 - 03	317
PO - 903 - 26	308	PO - 920 - 23	311	PO - 932 - 12	315	PO - 949 - 01	317
PO - 904 - 14	308	PO - 921 - 18	311	PO - 933 - 12	315	PO - 949 - 02	317
PO - 904 - 18	308	PO - 921 - 23	311	PO - 934 - 16	315	PO - 949 - 03	317

INDEX

OEM NO	PAGE	OEM NO	PAGE	OEM NO	PAGE	OEM NO	PAGE
PO - 950 - 14	318	RG - 100 - 03	341	RG - 337 - 16	342	RG - 610 - 15	345
PO - 951 - 14	318	RG - 100 - 04	341	RG - 342 - 18	342	RG - 610 - 16	345
PO - 952 - 14	318	RG - 100 - 05	341	RG - 350 - 14	342	RG - 610 - 22	345
PO - 953 - 14	318	RG - 101 - 02	341	RG - 355 - 16	342	RG - 611 - 14	345
PO - 954 - 18	318	RG - 101 - 03	341	RG - 360 - 18	342	RG - 612 - 02	345
PO - 955 - 18	318	RG - 101 - 04	341	RG - 351 - 14	342	SO - 200 - 11	347
PO - 956 - 18	318	RG - 102 - 02	341	RG - 356 - 16	342	SO - 200 - 13	347
PO - 957 - 18	318	RG - 102 - 03	341	RG - 361 - 18	342	SO - 200 - 14	347
PO - 958 - 01	319	RG - 102 - 04	341	RG - 365 - 02	343	SO - 200 - 16	347
PO - 958 - 02	319	RG - 300 - 14	342	RG - 365 - 03	343	SO - 200 - 18	347
PO - 959 - 16	319	RG - 310 - 16	342	RG - 365 - 04	343	SO - 200 - 20	347
PO - 959 - 18	319	RG - 315 - 18	342	RG - 366 - 03	343	SO - 200 - 25	347
PO - 959 - 20	319	RG - 301 - 14	342	RG - 366 - 04	343	SO - 201 - 11	347
PO - 959 - 23	319	RG - 311 - 16	342	RG - 367 - 03	343	SO - 201 - 13	347
PO - 959 - 26	319	RG - 316 - 18	342	RG - 367 - 04	343	SO - 201 - 14	347
PO - 960 - 14	319	RG - 302 - 14	342	RG - 500 - 00	344	SO - 201 - 16	347
PO - 961 - 13	319	RG - 312 - 16	342	RG - 500 - 01	344	SO - 201 - 18	347
PO - 962 - 22	319	RG - 317 - 18	342	RG - 500 - 02	344	SO - 201 - 20	347
PO - 970 - 23	320	RG - 313 - 16	342	RG - 500 - 03	344	SO - 201 - 25	347
PO - 971 - 18	320	RG - 318 - 18	342	RG - 500 - 04	344	SO - 202 - 11	347
PO - 971 - 26	320	RG - 314 - 16	342	RG - 510 - 35	344	SO - 202 - 13	347
PO - 972 - 27	320	RG - 319 - 18	342	RG - 510 - 50	344	SO - 202 - 14	347
PO - 980 - 27	320	RG - 330 - 14	342	RG - 600 - 01	345	SO - 202 - 16	347
PO - 981 - 27	320	RG - 335 - 16	342	RG - 600 - 02	345	SO - 202 - 18	347
PO - 982 - 20	320	RG - 340 - 18	342	RG - 605 - 00	345	SO - 202 - 20	347
PO - 982 - 24	320	RG - 331 - 14	342	RG - 610 - 09	345	SO - 202 - 25	347
PO - 982 - 26	320	RG - 336 - 16	342	RG - 610 - 13	345	SO - 203 - 14	347
RG - 100 - 02	341	RG - 341 - 18	342	RG - 610 - 14	345	SO - 203 - 16	347

INDEX

OEM NO	PAGE	OEM NO	PAGE	OEM NO	PAGE	OEM NO	PAGE
SO - 203 - 18	347	SO - 210 - 45	350	SO - 214 - 18	349	SO - 501 - 35	351
SO - 203 - 20	347	SO - 210 - 50	350	SO - 215 - 28	349	SO - 501 - 40	351
SO - 204 - 10	347	SO - 211 - 10	350	SO - 216 - 03	349	SO - 501 - 45	351
SO - 205 - 11	347	SO - 211 - 12	348	SO - 216 - 06	349	SO - 501 - 50	351
SO - 205 - 13	347	SO - 211 - 14	348	SO - 216 - 09	349	SO - 501 - 70	351
SO - 205 - 14	347	SO - 211 - 15	350	SO - 216 - 12	349	SO - 501 - 90	351
SO - 205 - 16	347	SO - 211 - 16	348	SO - 217 - 01	349	SO - 502 - 50	351
SO - 205 - 18	347	SO - 211 - 18	348	SO - 217 - 02	349	SO - 553 - 02	352
SO - 205 - 20	347	SO - 211 - 20	350	SO - 217 - 03	349	SO - 553 - 03	352
SO - 206 - 14	347	SO - 211 - 25	350	SO - 218 - 09	349	SO - 553 - 04	352
SO - 207 - 11	347	SO - 211 - 30	350	SO - 500 - 05	351	SO - 553 - 06	352
SO - 207 - 13	347	SO - 211 - 35	350	SO - 500 - 10	351	SO - 553 - 07	352
SO - 207 - 14	347	SO - 211 - 40	350	SO - 500 - 15	351	SO - 553 - 08	352
SO - 207 - 16	347	SO - 211 - 45	350	SO - 500 - 20	351	SO - 553 - 10	352
SO - 207 - 18	347	SO - 211 - 50	350	SO - 500 - 25	351	SO - 553 - 12	352
SO - 208 - 16	347	SO - 212 - 05	350	SO - 500 - 30	351	SO - 553 - 14	352
SO - 209 - 20	348	SO - 212 - 10	350	SO - 500 - 35	351	SO - 554 - 12	352
SO - 210 - 01	348	SO - 212 - 12	348	SO - 500 - 40	351	SO - 555 - 28	353
SO - 210 - 02	348	SO - 212 - 14	348	SO - 500 - 45	351	SO - 555 - 38	353
SO - 210 - 03	348	SO - 212 - 15	350	SO - 500 - 50	351	SO - 555 - 45	353
SO - 210 - 04	348	SO - 212 - 16	348	SO - 500 - 70	351	SO - 556 - 28	353
SO - 210 - 10	350	SO - 212 - 18	348	SO - 500 - 90	351	SO - 556 - 38	353
SO - 210 - 15	350	SO - 212 - 20	350	SO - 501 - 05	351	SO - 556 - 45	353
SO - 210 - 20	350	SO - 212 - 25	350	SO - 501 - 10	351	SO - 557 - 28	353
SO - 210 - 25	350	SO - 212 - 30	350	SO - 501 - 15	351	SO - 557 - 38	353
SO - 210 - 30	350	SO - 212 - 40	350	SO - 501 - 20	351	SO - 557 - 45	353
SO - 210 - 35	350	SO - 212 - 50	350	SO - 501 - 25	351	SP - 100 - 19	354
SO - 210 - 40	350	SO - 213 - 16	349	SO - 501 - 30	351	SP - 100 - 23	354

INDEX

OEM NO	PAGE	OEM NO	PAGE	OEM NO	PAGE	OEM NO	PAGE
SP - 101 - 23	354	SP - 200 - 22	356	SP - 255 - 00	358	SP - 285 - 01	360
SP - 101 - 24	354	SP - 200 - 23	356	SP - 255 - 01	358	SP - 285 - 02	360
SP - 102 - 20	354	SP - 200 - 24	356	SP - 255 - 25	358	SP - 285 - 03	360
SP - 103 - 21	354	SP - 200 - 25	356	SP - 255 - 27	358	SP - 500 - 01	361
SP - 105 - 17	355	SP - 200 - 26	356	SP - 255 - 30	358	SP - 500 - 02	361
SP - 105 - 20	355	SP - 200 - 27	356	SP - 256 - 01	358	SP - 500 - 03	361
SP - 105 - 23	355	SP - 200 - 28	356	SP - 256 - 02	358	SP - 500 - 04	361
SP - 106 - 14	355	SP - 200 - 29	356	SP - 256 - 03	358	SP - 500 - 05	361
SP - 107 - 21	355	SP - 200 - 30	356	SP - 257 - 24	359	SP - 500 - 06	361
SP - 107 - 26	367	SP - 210 - 01	356	SP - 257 - 32	359	SP - 500 - 07	361
SP - 107 - 27	355	SP - 210 - 02	356	SP - 257 - 36	359	SP - 500 - 08	361
SP - 108 - 25	367	SP - 210 - 03	356	SP - 257 - 37	359	SP - 500 - 09	361
SP - 109 - 28	367	SP - 210 - 04	356	SP - 258 - 24	359	SP - 500 - 10	361
SP - 200 - 08	356	SP - 210 - 05	356	SP - 258 - 32	359	SP - 500 - 11	361
SP - 200 - 08	356	SP - 210 - 06	356	SP - 258 - 36	359	SP - 500 - 12	361
SP - 200 - 09	356	SP - 210 - 07	356	SP - 258 - 37	359	SP - 500 - 13	361
SP - 200 - 10	356	SP - 210 - 08	356	SP - 259 - 29	359	SP - 500 - 14	361
SP - 200 - 11	356	SP - 210 - 09	356	SP - 259 - 35	359	SP - 500 - 15	361
SP - 200 - 12	356	SP - 210 - 10	356	SP - 260 - 33	359	SP - 500 - 16	361
SP - 200 - 13	356	SP - 210 - 11	356	SP - 260 - 35	359	SP - 500 - 17	361
SP - 200 - 14	356	SP - 210 - 12	356	SP - 260 - 43	359	SP - 500 - 18	361
SP - 200 - 15	356	SP - 210 - 13	356	SP - 265 - 20	360	SP - 500 - 19	361
SP - 200 - 16	356	SP - 250 - 00	357	SP - 265 - 30	360	SP - 500 - 20	361
SP - 200 - 17	356	SP - 250 - 01	357	SP - 265 - 33	360	SP - 500 - 21	361
SP - 200 - 18	356	SP - 250 - 28	357	SP - 270 - 22	360	SP - 500 - 22	361
SP - 200 - 19	356	SP - 250 - 32	357	SP - 270 - 25	360	SP - 500 - 23	361
SP - 200 - 20	356	SP - 250 - 35	357	SP - 280 - 01	360	SP - 500 - 24	361
SP - 200 - 21	356	SP - 250 - 40	357	SP - 280 - 02	360	SP - 500 - 25	361

INDEX

OEM NO	PAGE	OEM NO	PAGE	OEM NO	PAGE	OEM NO	PAGE
SP - 500 - 26	361	SP - 506 - 02	361	YC - 210 - 22	373		
SP - 501 - 01	361	SP - 506 - 04	361	YC - 211 - 22	373		
SP - 501 - 02	361	SP - 506 - 06	361	YC - 212 - 24	373		
SP - 501 - 04	361	SP - 506 - 08	361	YC - 213 - 24	373		
SP - 501 - 05	361	SP - 506 - 10	361	YC - 214 - 25	374		
SP - 501 - 06	361	SP - 506 - 12	361	YC - 215 - 26	374		
SP - 501 - 07	361	SP - 506 - 14	361	YC - 215 - 28	374		
SP - 501 - 09	361	SP - 506 - 16	361				
SP - 501 - 10	361	SP - 506 - 18	361				
SP - 501 - 11	361	TN - 100 - 16	363				
SP - 501 - 12	361	TN - 100 - 17	363				
SP - 501 - 13	361	TN - 101 - 25	364				
SP - 501 - 14	361	TN - 102 - 25	364				
SP - 501 - 15	361	TN - 103 - 25	365				
SP - 501 - 16	361	TN - 104 - 25	365				
SP - 501 - 17	361	TN - 105 - 24	366				
SP - 505 - 06	361	TN - 106 - 25	366				
SP - 505 - 07	361	YC - 200 - 17	369				
SP - 505 - 08	361	YC - 201 - 23	369				
SP - 505 - 09	361	YC - 202 - 34	369				
SP - 505 - 10	361	YC - 203 - 27	370				
SP - 505 - 11	361	YC - 204 - 34	370				
SP - 505 - 12	361	YC - 205 - 29	370				
SP - 505 - 13	361	YC - 206 - 26	371				
SP - 505 - 14	361	YC - 207 - 28	371				
SP - 505 - 15	361	YC - 208 - 24	372				
SP - 505 - 16	361	YC - 208 - 25	372				
SP - 505 - 17	361	YC - 209 - 26	372				