

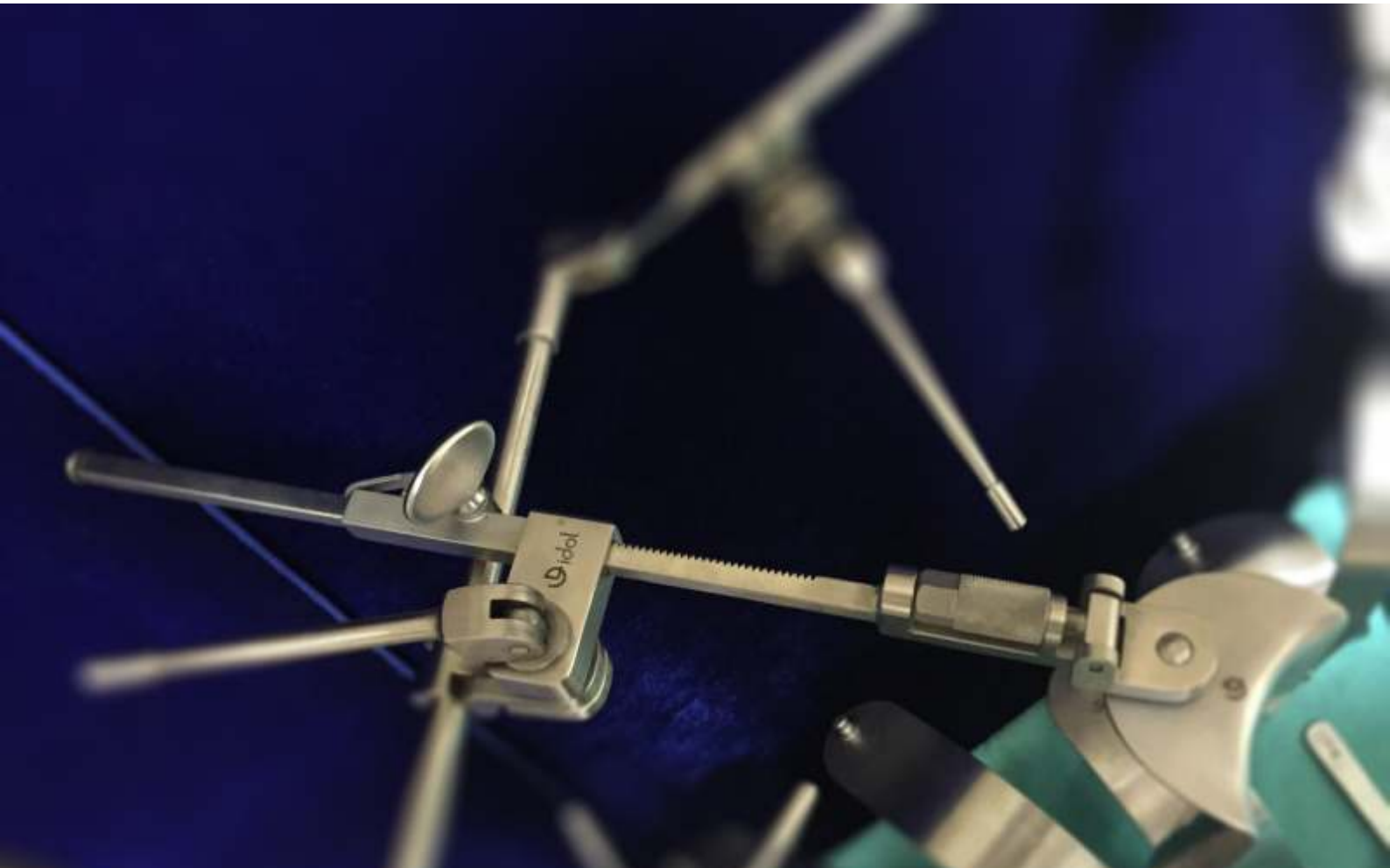

Universal Retractor System



We Shape Steel for Health



Universal Retractor System

- Easy to install
- Convenient work in operation field
- Usability in various operations
- Wide range of instrument usage
- Adjustable installation for various positions
- Maximum retraction with minimum person
- Multiple retraction

Unilateral Frame

- Easy cam lock joints
- independent lateral arms
- All one-piece components



Bilateral Frame

- Bilateral rigidity
- Multi-plane retraction

Cross Bars and Rail Clamps

Surgical Instruments

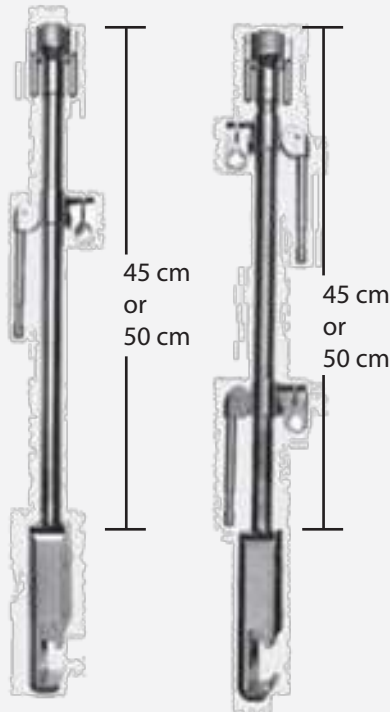

UE 100-01 45 cm
UE 100-02 50 cm
 Rail clamp with
 single cam joint

UE 100-03 45 cm
UE 100-04 50 cm
 Rail clamp with two
 cam joints



UE 100-05 60cm
 Cross bar with two cam joints
 (including two pieces of **UE 101-01**)



UE 100-06 50 cm
 Cross bar with single
 cam joint

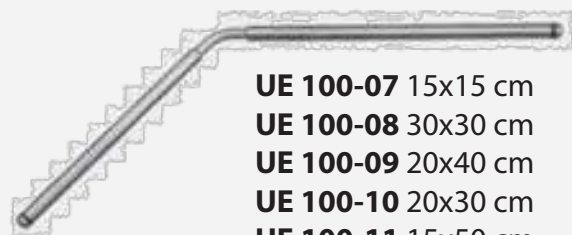

UE 100-07 15x15 cm
UE 100-08 30x30 cm
UE 100-09 20x40 cm
UE 100-10 20x30 cm
UE 100-11 15x50 cm
 Angled cross bar



UE 100-12 30 cm
UE 100-13 50 cm
 Straight arm



UE 100-14 30x30 cm
 Hinged extension arm



UE 100-15 28x21x28 cm
UE 100-16 35x25x35 cm
 Bilateral cross bar

Cam Joints

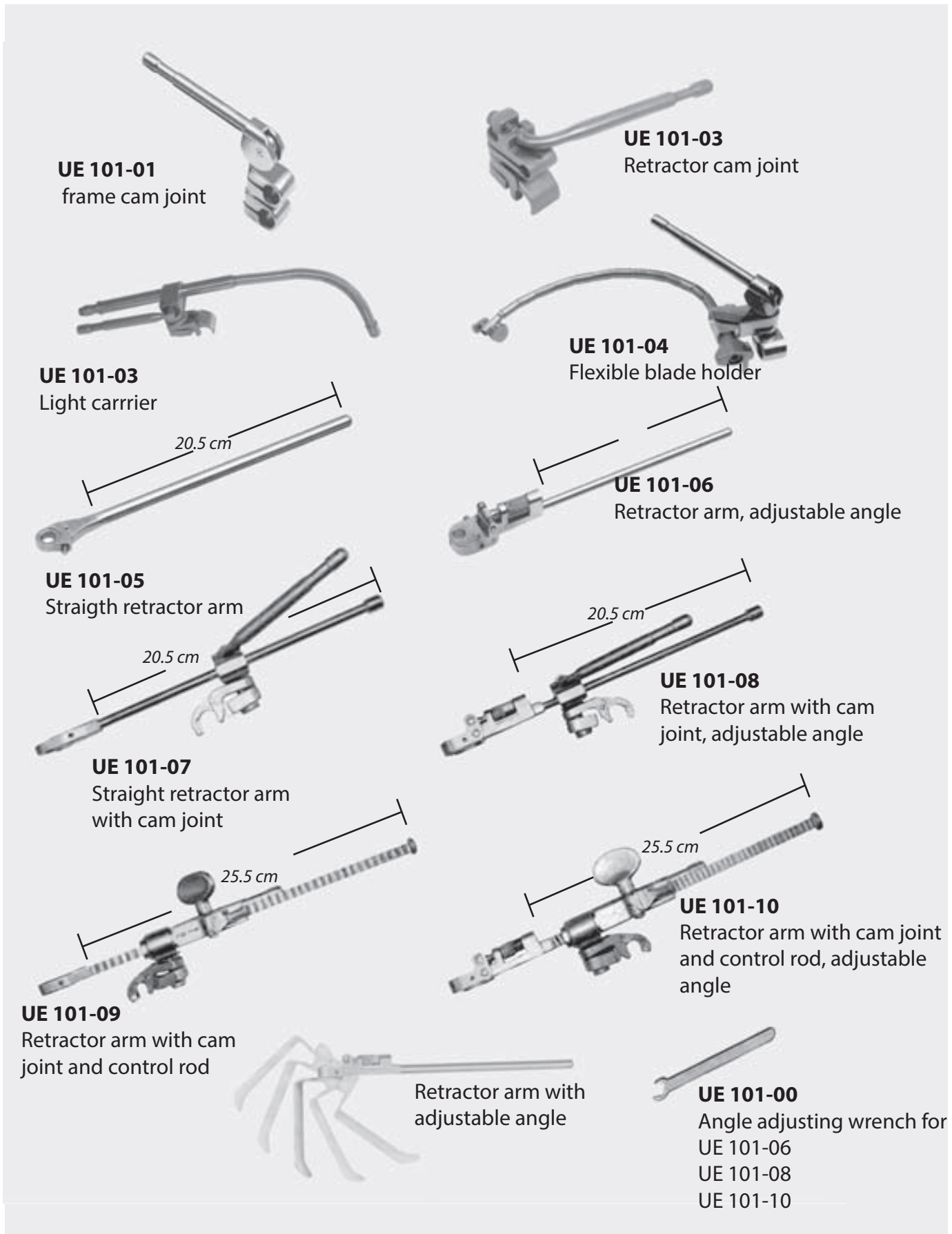

Abdominal/Vascular Retractors



Surgical Instruments



- UE 102-01** 65x13mm
 - UE 102-02** 90x13 mm
 - UE 102-03** 150x13mm
 - UE 102-04** 200x13mm
 - UE 102-05** 100x25mm
 - UE 102-06** 110x25mm
 - UE 102-07** 130x25mm
 - UE 102-08** 200x25mm
 - UE 102-09** 250x25mm
 - UE 102-10** 200x40mm
 - UE 102-11** 250x40mm
 - UE 102-12** 100x50mm
 - UE 102-13** 200x50mm
 - UE 102-14** 250x50mm
 - UE 102-15** 250x65mm
 - UE 102-16** 250x75mm
 - UE 102-17** 250x100mm
- Blade, malleable



DEAVER

- UE 102-20** 125x25mm
 - UE 102-21** 125x40mm
 - UE 102-22** 125x50mm
 - UE 102-23** 125x60mm
 - UE 102-24** 125x80mm
- Blades



- UE 102-25** 140x25mm
 - UE 102- 26** 200x25mm
- Vein blades,malleable



- UE 102-27** 140x25mm
 - UE 102-28** 200x25mm
- Vein blades, malleable



HARRINGTON

- UE 102-30** 125x40mm
 - UE 102-31** 100x65mm
 - UE 102-32** 150x65mm
 - UE 102-33** 200x65mm
 - UE 102-34** 250x65mm
- Blades



- UE 102-35** 150mm
- Finger blade, malleable

Abdominal/Vascular/Gynecology Colon Retractors



Surgical Instruments

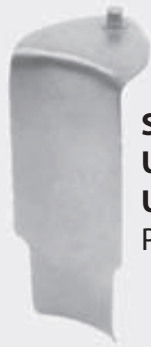

ST.MARKS
UE 102-40 140X65 mm
UE 102-41 180X65 mm
Pelvic blades



HEANY
UE 102-42 100x25 mm
UE 102-43 130x25mm
Blades



FENCE
UE 102-45 110x50 mm
UE 102-46 150x50 mm
UE 102-47 100x100 mm
UE 102-48 125x100mm
UE 102-49 150x100 mm
UE 102-50 200x100 mm
Blades



KELLY
UE 102-51 50x40 mm
UE 102-52 60x50 mm
UE 102-53 70x60 mm
UE 102-54 90x80 mm
Blades



BALFOUR
UE 102-55 30x30mm
UE 102-56 30x50 mm
UE 102-57 60x50 mm
UE 102-58 50x70mm
UE 102-59 75x70 mm
UE 102-60 60x80 mm
UE 102-61 75x80mm
UE 102-62 125x80 mm
UE 102-63 150x90 mm
UE 102-64 60x100 mm
Center blades



BALFOUR
UE 102-65 90 mm
UE 102-66 130 mm
Blades



RICHARDSON
UE 102-70 25x20 mm
UE 102-71 150x20 mm
UE 102-72 30x25 mm
UE 102-73 50x45mm
Mini blades



RICHARDSON
UE 102-75 75x50 mm
UE 102-76 100x50 mm
UE 102-77 125x50 mm
UE 102-78 150x50mm
UE 102-79 170x50 mm
Blades

Abdominal/Rectal/Urology Retractors



Surgical Instruments

MURPHY

Rake blades

UE 102-80 13x19cm

Sharp

UE 102-81 13x19cm

Blunt

UE 102-82 13x25cm

Sharp

UE 102-81 13x25cm

Blunt



VOLKMAN

blades

UE 102-84 13x16cm

Sharp

UE 102-85 13x16cm

Blunt

UE 102-86 13x25cm

Sharp

UE 102-87 13x25cm

Blunt



HILL-FERGUSON

UE 102-90 65x25cm

UE 102-91 75x30cm

Rectal blade

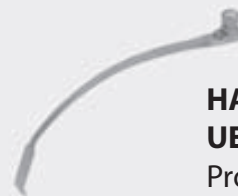

HARRIS

UE 102-92 65x25cm

Prostate blades



UE 102-93 65x25cm

Double angled pocket blades



UE 102-94 70x13cm

UE 102-95 75x13cm

UE 102-96 65x25cm

UE 102-97 75x25cm

Double angled blades



UE 102-98 130x80cm

'Y' bladder

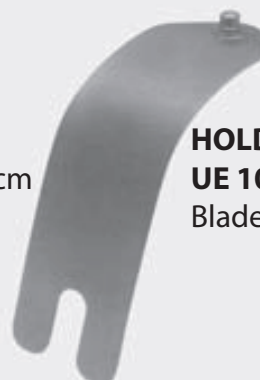

HOLDGREWE

UE 102-99 150x60cm

Blade

Spinal/Cervical/Lumbar Retractors



Surgical Instruments



MEYERDING
UE 103-01 50x16mm
UE 103-02 75x16mm
UE 103-03 100x16mm
UE 103-04 50x25mm
UE 103-05 75x25mm
UE 103-06 100x25mm



MEYERDING
UE 103-07 50x16mm
UE 103-08 75x16mm
UE 103-09 100x16mm
UE 103-10 50x25mm
UE 103-11 75x25mm
UE 103-12 100x25mm



MEYERDING
UE 103-20 80x20mm
UE 103-21 80x45mm
UE 103-22 80x60mm
UE 103-23 100x20mm
UE 103-24 100x45mm
UE 103-25 100x60mm
UE 103-26 120x20mm
UE 103-27 120x45mm
UE 103-28 120x60mm
 Concave posterior lumbar blades



UE 103-30 75mm
UE 103-31 100mm
 Prong blades



UE 103-40 40x16mm
UE 103-41 45x16mm
UE 103-42 50x16mm
UE 103-43 55x16mm
UE 103-44 60x16mm



UE 103-45 40x16mm
UE 103-46 45x16mm
UE 103-47 50x16mm
UE 103-48 55x16mm
UE 103-49 60x16mm
 Blade



UE 103-50 55x20mm
UE 103-51 30x25mm
UE 103-52 40x25mm
UE 103-53 50x25mm
UE 103-54 60x25mm
UE 103-55 70x25mm
UE 103-56 80x25mm
 Lumbar retractor curved point



UE 103-60 50x13mm
UE 103-61 75x13mm
UE 103-62 100x13mm
UE 103-63 50x19mm
UE 103-64 75x19mm
UE 103-65 100x19mm
UE 103-66 50x25mm
UE 103-67 75x25mm
UE 103-68 100x25mm
 Lumbar retractor straight point



UE 103-70 100x25mm
UE 103-71 150x25mm
UE 103-72 200x25mm
UE 103-73 250x25mm
UE 103-74 100x30mm
UE 103-75 150x30mm
UE 103-76 200x30mm
UE 103-77 250x30mm
 Anterior lumbar blades

Standard Frame Kits

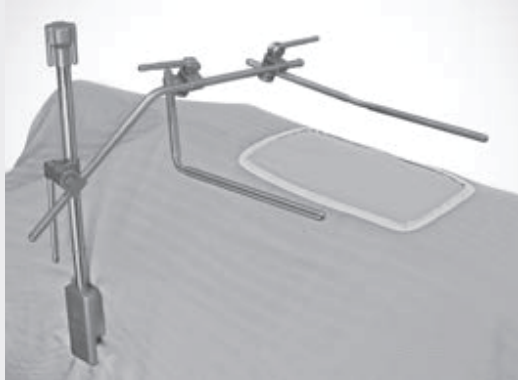

PRODUCT CODES	ITEM DESCRIPTION	QTY
UE 110-01	Unilateral Frame Kit	
UE 100-01	Rail clamp with single cam joint	1
UE 100-05	Cros bar with 2 cam joints 60cm(inc. 2 pcs. of UE 101-01)	1
UE 100-10	Angled cross bar 20x30cm	2
UE 100-09	Angled cross bar 20x40cm	2
UE 101-08	Retractor arm with cam joint, adjustable angle 25.5cm	3
UE 101-10	Retractor arm with cam joint and ctrl. rod, adjustable angle 20.5	2
UE 101-00	Angle adjusting wrench	1

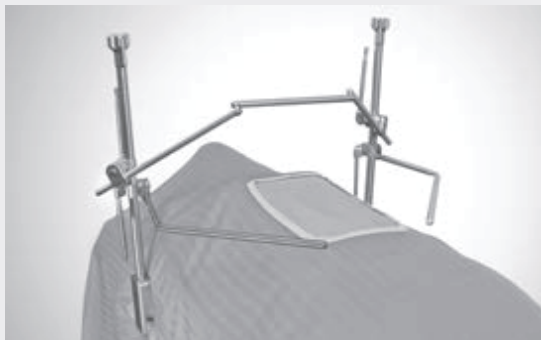

PRODUCT CODES	ITEM DESCRIPTION	QTY
UE 110-02	Bilateral Frame Kit	
UE 100-04	Rail clamp with 2 cam joints 50cm	2
UE 100-15	Bilateral cross bar 28x21x28cm	1
UE 100-16	Bilateral cross bar 35x25x35cm	1
UE 100-08	Angled cross bar 30x30cm	2
UE 101-08	Retractor arm with cam joint, adjustable angle 25.5cm	5
UE 101-10	Retractor arm with cam joint and ctrl. rod, adjustable angle 20.5cm	2
UE 101-00	Angle adjusting wrench	1

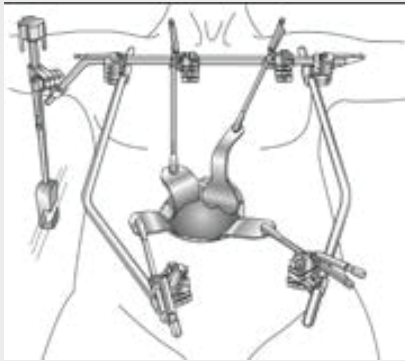

GENERAL BLADE KIT (Unilateral frame kit required)

PRODUCT CODES	ITEM DESCRIPTION	QTY
UE 111-01	General blade kit	
UE 102-26	Vein blade 200x25mm	1
UE 102-15	Maleable blade 250x65mm	1
UE 102-53	Kelly blade 70x60mm	1
UE 102-54	Kelly blade 90x80mm	1
UE 102-49	Fence blade 150x100mm	1
UE 102-60	Balfour blade 60x80mm	2
UE 102-77	Richardson blade 125x50mm	1
UE 102-32	Harrington blade 150x65mm	1
UE 102-22	Deaver blade 125x50mm	1

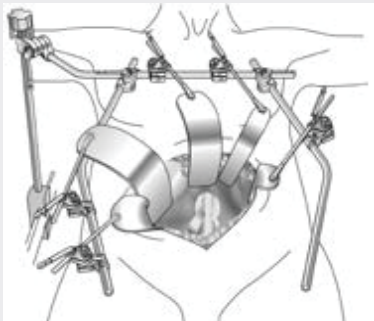

GENERAL BLADE KIT (Unilateral or bilateral frame kit required)

PRODUCT CODES	ITEM DESCRIPTION	QTY
UE 111-02	General/Vascular blade kit	
UE 102-08	Maleable blade 200x25mm	1
UE 102-28	Maleable vein blade 200x25mm	1
UE 102-13	Maleable blade 200x50mm	2
UE 102-15	Maleable blade 200x65mm	1
UE 102-16	Maleable blade 200x75mm	1
UE 102-71	Richardson mini blade 50x20mm	2
UE 102-53	Kelly blade 70x60mm	1
UE 102-47	Fence blade 100x100mm	1
UE 102-48	Fence blade 125x100mm	1
UE 102-49	Fence blade 150x100mm	1
UE 102-59	Balfour blade 75x70mm	2
UE 102-61	Balfour blade 75x80mm	1
UE 102-65	Balfour blade 90mm	2
UE 102-77	Richardson blade 125x50mm	2
UE 102-32	Harrington blade 150x65mm	1
UE 102-22	Deaver blade 125x50mm	1
UE 102-41	St. Marks pelvic blade 180x65mm	1
UE 102-35	Maleable finger blade 150mm	1
UE 102-60	Balfour blade 60x80mm	1
UE 102-64	Balfour blade 60x100mm	1
UE 102-62	Balfour blade 125x80mm	

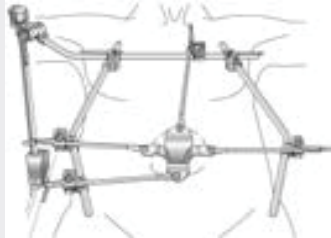

COLON/RECTAL BLADE KIT (Unilateral frame kit required)

PRODUCT CODES ITEM DESCRIPTION QTY

UE 111-03 Colon/Rectal blade kit

UE 102-65	Balfour blade 90mm	2
UE 102-20	Deaver blade 125x25mm	2
UE 102-90	Hill-Ferguson rectal blade 65x25mm	2
UE 102-91	Hill-Ferguson rectal blade 75x30mm	1
UE 102-40	St. Marks pelvic blade 140x65mm	1
UE 102-41	St. Marks pelvic blade 180x65mm	1

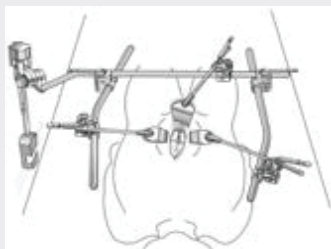

PEDIATRIC BLADE KIT (Unilateral frame required)

PRODUCT CODES ITEM DESCRIPTION QTY

UE 111-04 Pediatric blade kit

UE 102-01	Maleable blade 65x13mm	2
UE 102-03	Maleable blade 150x13mm	2
UE 102-04	Maleable blade 200x13mm	2
UE 102-05	Maleable blade 100x25mm	2
UE 102-12	Maleable blade 100x50mm	2
UE 102-70	Richardson mini blade 25x20mm	1
UE 102-71	Richardson mini blade 50x20mm	1
UE 102-72	Richardson mini blade 30x25mm	1
UE 102-51	Kelly blade 50x40mm	1
UE 102-52	Kelly blade 60x50mm	1
UE 102-58	Balfour blade 50x70mm	1
UE 102-55	Balfour blade 30x30mm	2
UE 102-57	Balfour blade 60x50mm	1
UE 102-76	Richardson blade 100x50mm	1
UE 102-30	Harrington blade 125x40mm	1
UE 102-20	Deaver blade 125x25mm	1

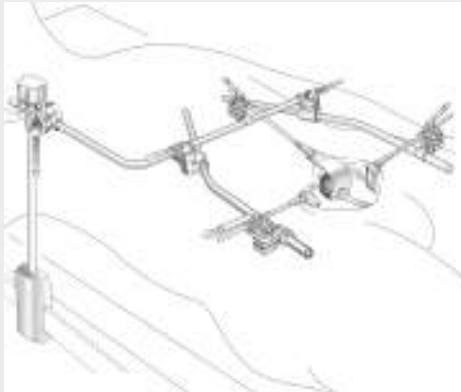

ABDOMINAL UROLOGY BLADE KIT (Unilateral frame required)

PRODUCT CODES	ITEM DESCRIPTION	QTY
UE 111-05	Abdominal Urology blade kit	
UE 102-12	Maleable blade 100x50mm	1
UE 102-15	Maleable blade 250x65mm	1
UE 102-53	Kelly blade 70x60mm	2
UE 102-49	Fence blade 150x100mm	1
UE 102-99	Holtgrewe 150x60mm	1
UE 102-58	Balfour blade 50x70mm	2
UE 102-57	Balfour blade 60x50mm	2
UE 102-65	Balfour blade 90mm	2
UE 102-77	Richardson blade 125x50mm	1
UE 102-32	Harrington blade 150x65mm	1
UE 102-33	Harrington blade 200x65mm	1
UE 102-22	Deaver blade 125x50mm	1



KIDNEY TRANSPLANT BLADE KIT (Unilateral frame required)

PRODUCT CODES	ITEM DESCRIPTION	QTY
UE 111-06	Kidney Transplant blade kit	
UE 102-08	Maleable blade 200x25mm	2
UE 102-13	Maleable blade 200x50mm	2
UE 102-15	Maleable blade 250x65mm	2
UE 102-16	Maleable blade 250x75mm	2
UE 102-70	Richardson mini blade 25x20mm	1
UE 102-71	Richardson mini blade 50x20mm	1
UE 102-72	Richardson mini blade 35x25mm	1
UE 102-51	Kelly blade 50x40mm	1
UE 102-52	Kelly blade 60x50mm	1
UE 102-53	Kelly blade 70x60	1
UE 102-58	Balfour blade 50x70mm	2
UE 102-57	Balfour blade 60x50mm	2
UE 102-76	Richardson blade 100x50mm	1
UE 102-77	Richardson blade 125x50mm	1
UE 102-32	Harrington blade 150x65mm	1

HARRIS PERINEAL BLADE KIT (Unilateral frame required)

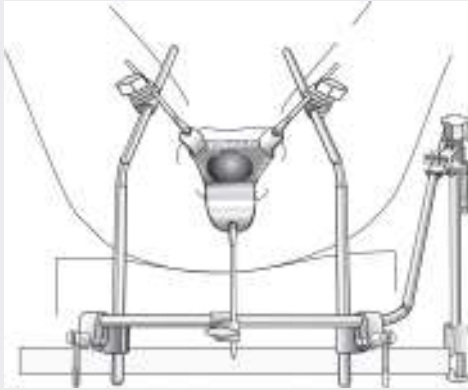

PRODUCT CODES	ITEM DESCRIPTION	QTY
UE 111-07	Harris Periental blade kit	
UE 102-92	Harris prostat blade	1
UE 102-97	Double angled blade 75x25cm	2
UE 102-96	Double angled blade 65x25cm	2
UE 102-95	Double angled blade 75x13cm	2
UE 102-94	Double angled blade 70x13cm	2
UE 102-93	Double angled pocket blade 70x13cm	1
UE 102-83	Murphy rake blade, blunt 13x25mm	1
UE 102-03	Malleable blade 150x13mm	1
UE 102-13	Malleable blade 200x50mm	1
UE 102-10	Malleable blade 200x40mm	1

POSTERIOR LUMBAR BLADE KIT (Unilateral frame required)



PRODUCT CODES	ITEM DESCRIPTION	QTY
UE 111-08	Posterior Lumbar blade kit	
UE 103-20	Concave posterior lumbar blade 80x20mm	2
UE 103-21	Concave posterior lumbar blade 80x45mm	2
UE 103-22	Concave posterior lumbar blade 80x45mm	2
UE 103-23	Concave posterior lumbar blade 100x20mm	2
UE 103-24	Concave posterior lumbar blade 100x45mm	2
UE 103-25	Concave posterior lumbar blade 100x60mm	2
UE 103-26	Concave posterior lumbar blade 80x45mm	2
UE 103-27	Concave posterior lumbar blade 120x45mm	2
UE 103-28	Concave posterior lumbar blade 120x60mm	2
UE 103-03	Meyerding blade 100x16mm	2
UE 103-05	Meyerding blade 75x25mm	2
UE 103-06	Meyerding blade 100x25mm	2
UE 103-09	Meyerding blade 100x16mm	2
UE 103-11	Meyerding blade 75x25mm	2
UE 103-12	Meyerding blade 100x25mm	2

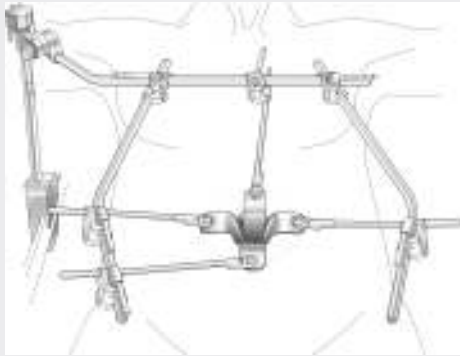

ANTERIOR LUMBAR BLADE KIT (Unilateral frame required)

PRODUCT CODES	ITEM DESCRIPTION	QTY
UE 111-09	Anterior Lumbar blade kit	
UE 102-27	Malleable vein blade 140x25mm	2
UE 102-28	Malleable vein blade 200x25mm	2
UE 102-25	Malleable vein blade 140x25mm	2
UE 102-26	Malleable vein blade 200x25mm	2
UE 103-70	Anterior Lumbar blade 100x25mm	2
UE 103-71	Anterior Lumbar blade 150x25mm	2
UE 103-72	Anterior Lumbar blade 200x25mm	2
UE 103-73	Anterior Lumbar blade 250x25mm	2
UE 103-74	Anterior Lumbar blade 100x30mm	2
UE 103-75	Anterior Lumbar blade 150x30mm	2
UE 103-76	Anterior Lumbar blade 200x30mm	2
UE 103-77	Anterior Lumbar blade 250x30mm	2

SPINAL SURGERY BLADE KIT (Unilateral frame required)

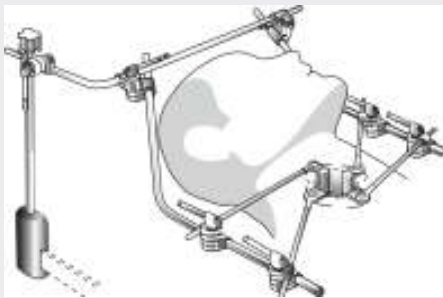

PRODUCT CODES	ITEM DESCRIPTION	QTY
UE 111-10	Spinal Surgery blade kit	
UE 103-40	Spinal blade 40x16mm	1
UE 103-41	Spinal blade 45x16mm	1
UE 103-42	Spinal blade 50x16mm	1
UE 103-43	Spinal blade 55x16mm	1
UE 103-44	Spinal blade 60x16mm	1
UE 103-45	Spinal blade with teeth 40x16mm	1
UE 103-46	Spinal blade with teeth 45x16mm	1
UE 103-47	Spinal blade with teeth 50x16mm	2
UE 103-48	Spinal blade with teeth 55x16mm	2
UE 103-49	Spinal blade with teeth 60x16mm	2
UE 103-50	Lumbar blade curved point 55x20mm	2
UE 103-51	Lumbar blade curved point 30x25mm	2
UE 103-52	Lumbar blade curved point 40x25mm	2
UE 103-53	Lumbar blade curved point 50x25mm	2
UE 103-54	Lumbar blade curved point 60x25mm	2
UE 103-55	Lumbar blade curved point 70x25mm	2
UE 103-56	Lumbar blade curved point 80x25mm	2

Product code	Page	Product code	Page	Product code	Page	Product code	Page
UE 100-01	2	UE 102-26	4	UE 102-86	6	UE 103-55	7
UE 100-02	2	UE 102-27	4	UE 102-87	6	UE 103-56	7
UE 100-03	2	UE 102-28	4	UE 102-90	6	UE 103-60	7
UE 100-04	2	UE 102-30	4	UE 102-91	6	UE 103-61	7
UE 100-05	2	UE 102-31	4	UE 102-92	6	UE 103-62	7
UE 100-06	2	UE 102-32	4	UE 102-93	6	UE 103-63	7
UE 100-07	2	UE 102-33	4	UE 102-94	6	UE 103-64	7
UE 100-08	2	UE 102-34	4	UE 102-95	6	UE 103-65	7
UE 100-10	2	UE 102-40	5	UE 102-97	6	UE 103-67	7
UE 100-11	2	UE 102-41	5	UE 102-98	6	UE 103-68	7
UE 100-12	2	UE 102-42	5	UE 102-99	6	UE 103-70	7
UE 100-13	2	UE 102-43	5	UE 103-01	7	UE 103-71	7
UE 100-14	2	UE 102-45	5	UE 103-02	7	UE 103-72	7
UE 100-15	2	UE 102-46	5	UE 103-03	7	UE 103-73	7
UE 100-16	2	UE 102-47	5	UE 103-04	7	UE 103-74	7
UE 101-00	3	UE 102-48	5	UE 103-05	7	UE 103-75	7
UE 101-01	3	UE 102-49	5	UE 103-06	7	UE 103-76	7
UE 101-02	3	UE 102-50	5	UE 103-07	7	UE 103-77	7
UE 101-03	3	UE 102-51	5	UE 103-08	7	UE 110-01	8
UE 101-04	3	UE 102-52	5	UE 103-09	7	UE 110-02	8
UE 101-05	3	UE 102-53	5	UE 103-10	7	UE 111-01	9
UE 101-06	3	UE 102-54	5	UE 103-11	7	UE 111-02	9
UE 101-07	3	UE 102-55	5	UE 103-12	7	UE 111-03	10
UE 101-08	3	UE 102-56	5	UE 103-20	7	UE 111-04	10
UE 101-09	3	UE 102-57	5	UE 103-21	7	UE 111-05	11
UE 101-10	3	UE 102-58	5	UE 103-22	7	UE 111-06	11
UE 102-01	4	UE 102-59	5	UE 103-23	7	UE 111-07	12
UE 102-02	4	UE 102-60	5	UE 103-24	7	UE 111-08	12
UE 102-03	4	UE 102-61	5	UE 103-25	7	UE 111-09	13
UE 102-04	4	UE 102-62	5	UE 103-26	7	UE 111-10	13
UE 102-05	4	UE 102-63	5	UE 103-27	7		
UE 102-06	4	UE 102-64	5	UE 103-28	7		
UE 102-07	4	UE 102-65	5	UE 103-30	7		
UE 102-08	4	UE 102-66	5	UE 103-31	7		
UE 102-09	4	UE 102-70	5	UE 103-40	7		
UE 102-10	4	UE 102-71	5	UE 103-41	7		
UE 102-11	4	UE 102-72	5	UE 103-42	7		
UE 102-12	4	UE 102-73	5	UE 103-43	7		
UE 102-13	4	UE 102-75	5	UE 103-44	7		
UE 102-14	4	UE 102-76	5	UE 103-45	7		
UE 102-15	4	UE 102-77	5	UE 103-46	7		
UE 102-16	4	UE 102-78	5	UE 103-47	7		
UE 102-17	4	UE 102-79	5	UE 103-48	7		
UE 102-20	4	UE 102-80	6	UE 103-49	7		
UE 102-21	4	UE 102-81	6	UE 103-50	7		
UE 102-22	4	UE 102-82	6	UE 103-51	7		
UE 102-23	4	UE 102-83	6	UE 103-52	7		
UE 102-24	4	UE 102-84	6	UE 103-53	7		
UE 102-25	4	UE 102-85	6	UE 103-54	7		



Surgical Instruments

Altinkale Mahallesi 4469 Sokak
Adem Yörük Sanayi Sitesi
D Blok No:5 07190
DÖŞEMEALTI/ANTALYA

Tel:+90 242 311 16 54 (pbx)
Fax: +90 242 317 04 40
GSM: 0549 717 68 15

www.idolcerrahi.com
info@idolcerrahi.com