

Aspratör Uçları
Suction Tubes
Saugrohre

Ø mm	11 cm/4¼"	13 cm/5"	16 cm/6¼"	20 cm/8"
ø 1,5 mm	AS 100-04	AS 101-04	AS 102-04	AS 103-04
ø 2,0 mm	AS 100-06	AS 101-06	AS 102-06	AS 103-06
ø 2,5 mm	AS 100-08	AS 101-08	AS 102-08	AS 103-08
ø 3,0 mm	AS 100-10	AS 101-10	AS 102-10	AS 103-10
ø 4,0 mm	AS 100-12	AS 101-12	AS 102-12	AS 103-12
ø 5,0 mm	AS 100-15	AS 101-15	AS 102-15	AS 103-15

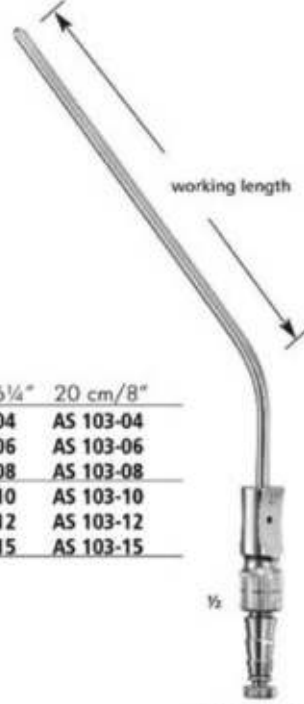

FERGUSSON

Ø mm	19 cm/7½"
ø 1,5 mm	AS 120-15
ø 2,0 mm	AS 120-20
ø 2,5 mm	AS 120-25
ø 3,0 mm	AS 120-30
ø 4,0 mm	AS 120-40
ø 5,0 mm	AS 120-50



FRAZIER

Ø mm	19 cm/7½"
ø 1,5 mm	AS 200-15
ø 2,0 mm	AS 200-20
ø 2,5 mm	AS 200-25
ø 3,0 mm	AS 200-30



PLESTER

Ø mm	13 cm/5"
ø 2,0 mm	AS 201-02
ø 3,0 mm	AS 201-03
ø 4,0 mm	AS 201-04
ø 5,0 mm	AS 201-05

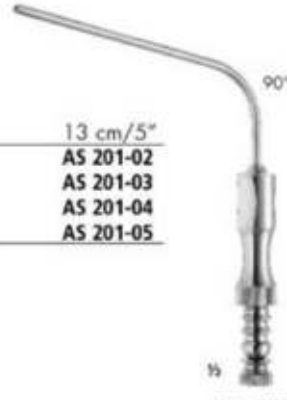

FRAZIER



FERGUSSON
AS 250-12
18 cm/7"

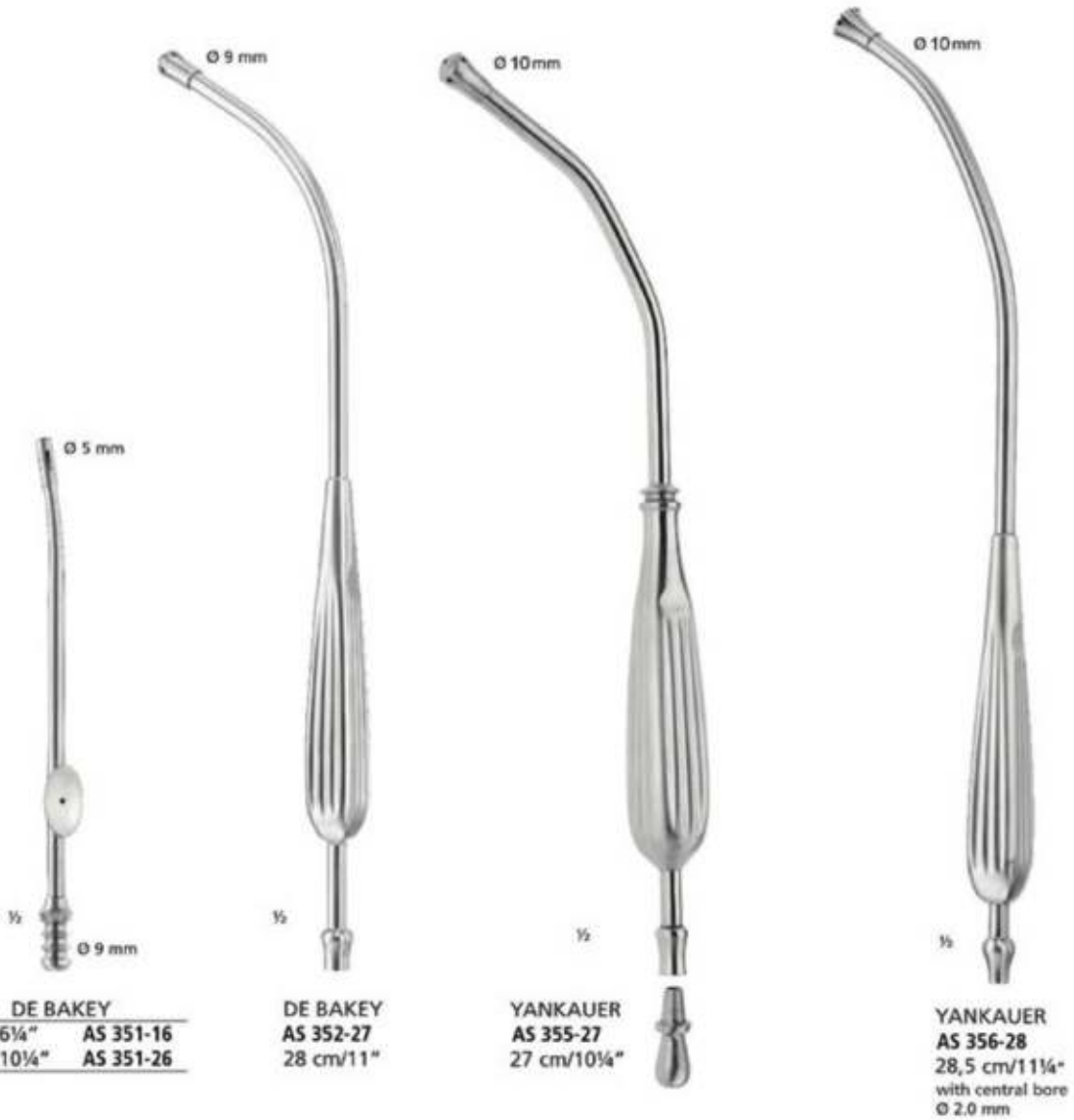

Aspratör Uçları
Suction Tubes
Saugrohre

Ø 10 mm
30 Fr.



POOLE
AS 360-01
23 cm/8 3/4"

Ø 8 mm
23-24 Fr.



POOLE
AS 360-02
23 cm/8 3/4"



FINSTERER
AS 365-32
32 cm/12 1/2"

Ø 4 mm

LANDOLT
AS 500-65



BS 200-03
13,5 cm/5¼"
Fig. 3
solid, cm-graduation



BS 200-04
13,5 cm/5¼"
Fig. 4
solid, cm-graduation



BS 201-03
13,5 cm/5¼"
Fig. 3



BS 201-04
13,5 cm/5¼"
Fig. 4



BS 202-13
21,5 cm/8½"
Fig. 3 L



BS 203-14
21 cm/8¼"
Fig. 4 L



BS 210-07
16 cm/6¼"
Fig. 7



BS 211-07
12,5 cm/5"
Fig. 7 K



BS 212-16
14,5 cm/5¾"
Fig. 3 R



BS 213-16
14 cm/5½"
Fig. 3 R



BS 220-21
21 cm/8¼"
Fig. 3 L

BS 221-21
21 cm/8¼"
Fig. 4 L

BS 230-16
16 cm/6¼"
No. 5

BS 231-21
21,5 cm/8½"
No. 5

BS 232-21
21 cm/8¼"
No. 5

Spanç ve Temizlik Klempleri
Sponge and Dressing Forceps
Korn und Tupferzangen



CM 200-13 13 cm/5"
CM 200-16 16 cm/6¼"
CM 200-18 18 cm/7"

without ratchet

LISTER

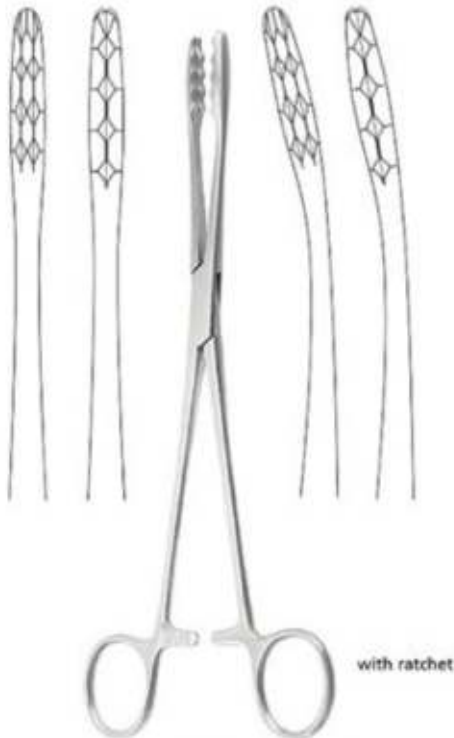

with ratchet

ULRICH

22 cm/8¾"	CM 201-22	CM 202-22
25 cm/10"	CM 201-25	CM 202-25



with ratchet

GROSS-MAIER

14 cm/5½"	CM 205-14	CM 206-14
18 cm/7"	CM 205-18	CM 206-18
20 cm/8"	CM 205-20	CM 206-20
22 cm/8¾"	CM 205-22	CM 206-22
25 cm/10"	CM 205-25	CM 206-25
27 cm/10½"	CM 205-27	CM 206-27



BOZEMANN
CM 210-26 26 cm/10¼"



BOZEMANN
CM 211-16 26 cm/10¼"



BOZEMANN DOUGLES
CM 212-26 26 cm/10¼"

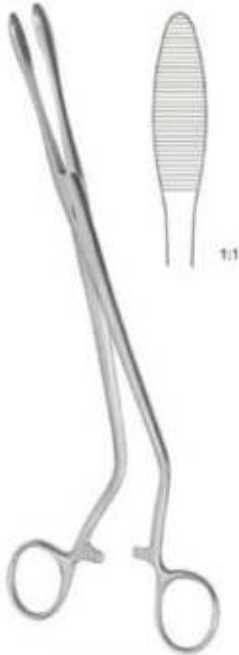

CHERON
CM 213-25 25 cm/10"



COLLIN
CM 214-24 24 cm/9½"

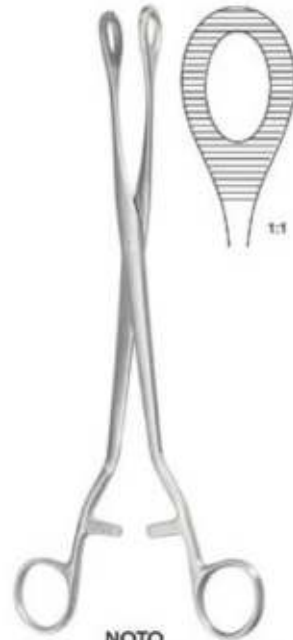

NOTO
CM 215-28 27,5 cm/10¾"

Spanç ve Temizlik Klempleri
Sponge and Dressing Forceps
Korn und Tupferzangen



FOERSTER

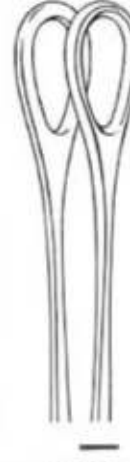
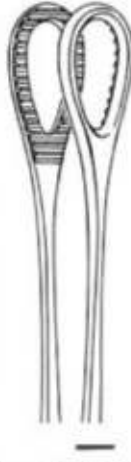

18 cm/7"	CM 223-18	CM 224-18	CM 225-18	CM 226-18
20 cm/8"	CM 223-20	CM 224-20	CM 225-20	CM 226-20
25 cm/10"	CM 223-25	CM 224-25	CM 225-25	CM 226-25



RAMPLEY

CM 229-25
25 cm/10"



SIMS-MAIER
CM-230-28 28 cm/11"

CM 231-28 28 cm/11"



ATRAUMA



CM 250-25
25 cm/10"



CM 250-27
27 cm/10½"



EK 217-08
8 mm



EK 218-08
8 mm



EK 219-08
8 mm



EK 217-10
10 mm



EK 218-10
10 mm



EK 219-10
10 mm



EK 217-12
12 mm



EK 218-12
12 mm



EK 219-12
12 mm



DESMARRES
16,5 cm/6½"



EK 217-14
14 mm



EK 218-14
14 mm



EK 219-14
14 mm



EK 217-16
16 mm



EK 218-16
16 mm



EK 219-16
16 mm



EK 217-18
18 mm



EK 218-18
18 mm



EK 219-18
18 mm



CUSHING
20 cm/8"



CUSHING
24 cm/9½"

**Ekartörler
Retractors
Wundhaken**



BABY SENN MILLER
15 cm/6"



SENN MILLER
16 cm/6¼"



RAGNELL DAVIS
EK 226-14
14 cm/5½"



CUSHING
EK 227-20
21,5 cm/8½"



VOLKMANN
21,5 cm/8½"

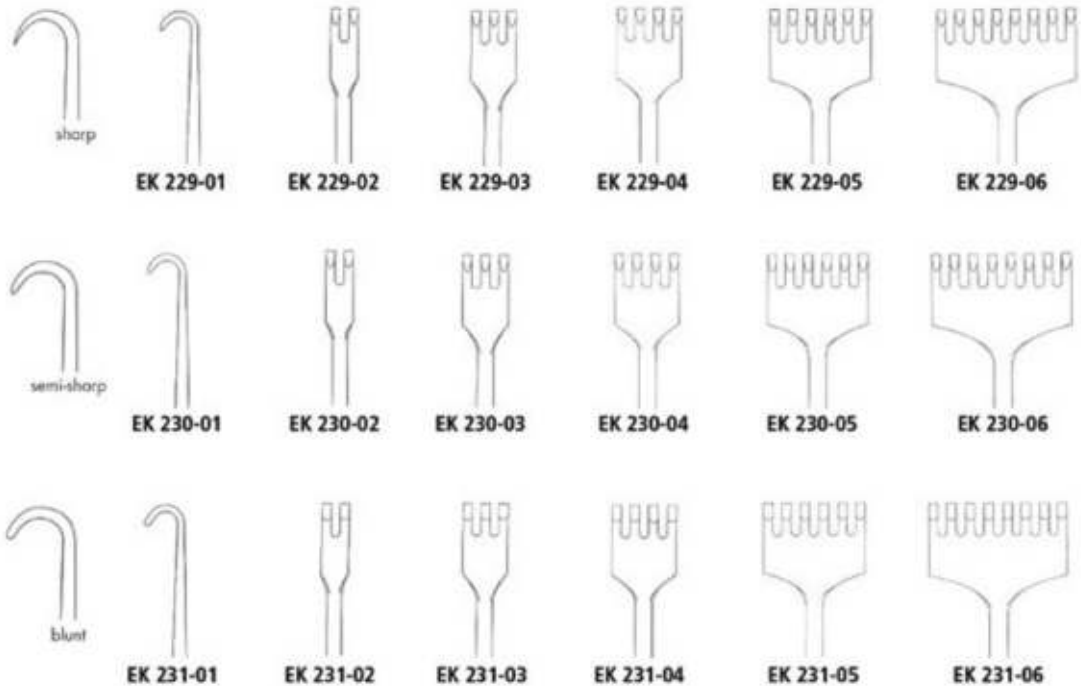

sharp	EK 229-01	EK 229-02	EK 229-03	EK 229-04	EK 229-05	EK 229-06
semi-sharp	EK 230-01	EK 230-02	EK 230-03	EK 230-04	EK 230-05	EK 230-06
blunt	EK 231-01	EK 231-02	EK 231-03	EK 231-04	EK 231-05	EK 231-06

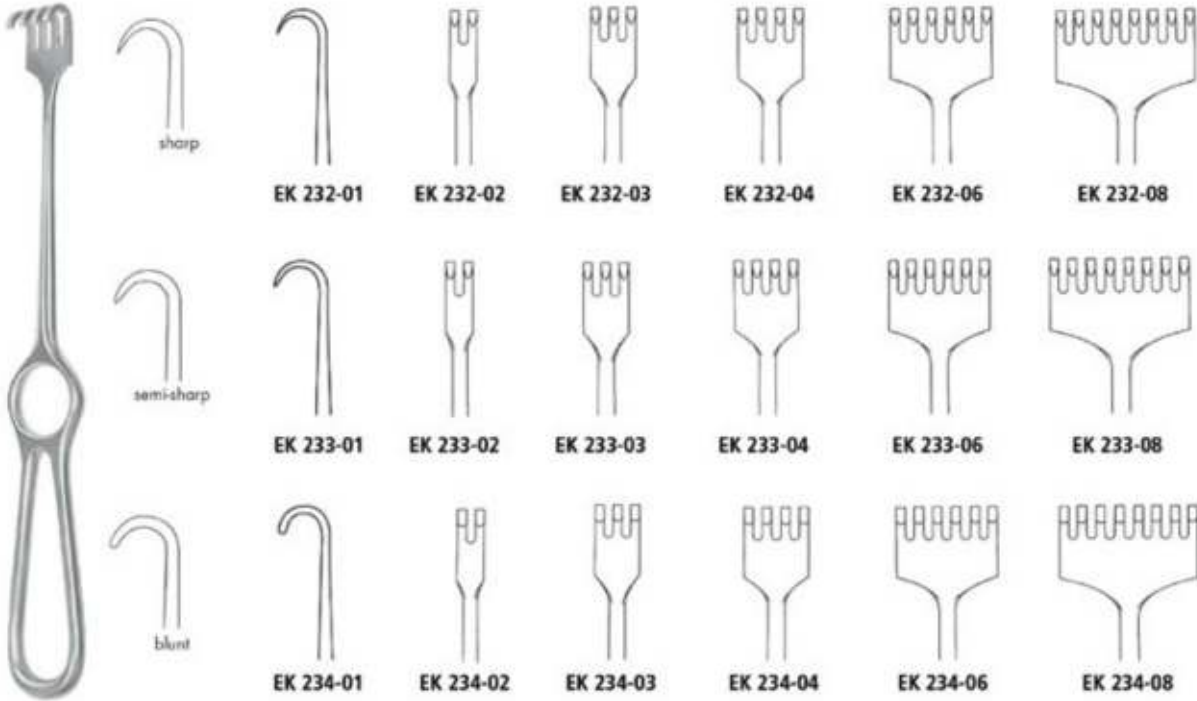

KOCHER
 22 cm/8¾"



VOLKMANN
EK 237-20
 21,5 cm/8½"



VOLKMANN
EK 238-20
 21,5 cm/8½"



VOLKMANN
EK 237-24
 21,5 cm/8½"

Ekartörler
Retractors
Wundhaken

İDOL
CERRAHİ ALETLER
www.idolcerrahi.com



EK 260-01
22 x 15 mm



EK 260-02
38 x 20 mm

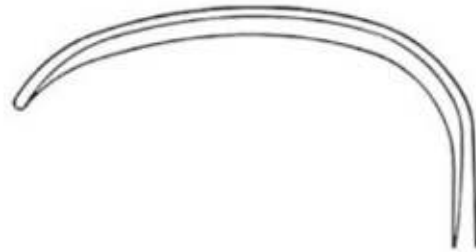

EK 260-03
67 x 25 mm

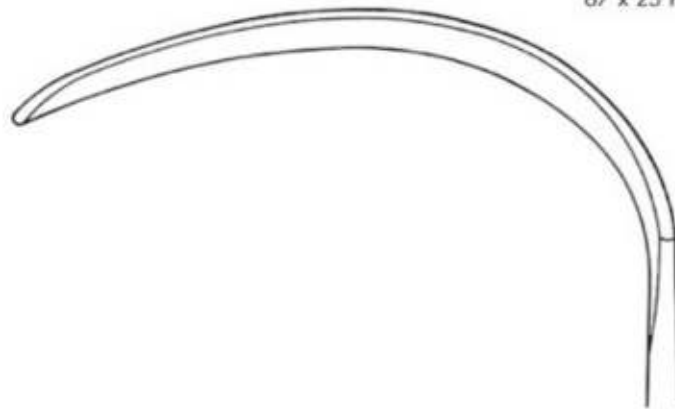

EK 260-04
100 x 35 mm



KOCHER WAGNER
28 cm/11"



KOCHER
25 cm/10"

80 x 45 mm	EK 261-45
80 x 55 mm	EK 261-55
80 x 65 mm	EK 261-65



KOCHER
EK 262-70
22,5 cm/8¾"
70 x 25 mm



½
KOCHER
19 cm/7½"



EK 263-01
19x12 mm



EK 263-02
21x14 mm



½
KOENIG
18 cm/7"



EK 264-01
13x13 mm



EK 264-02
13x16 mm



½
CUSHING-KOCHER
17,5 cm/7"

EK 264-10
10x10 mm

Ekartörler
Retractors
Wundhaken

İDOL
CERRAHİ ALETLER
www.idolcerrahi.com



ISRAEL
25 cm/10"



EK 351-40
40 x 40 mm



EK 351-50
45 x 50 mm



EK 351-60
50 x 60 mm

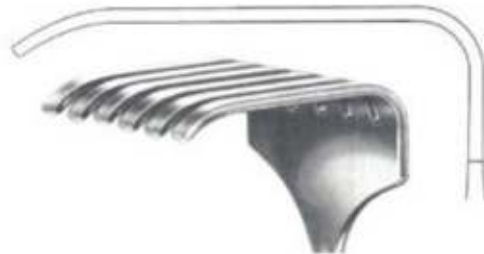

EK 351-70
70 x 70 mm

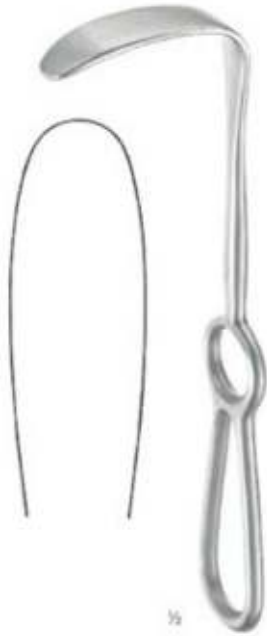

1/2
LANGENBECK

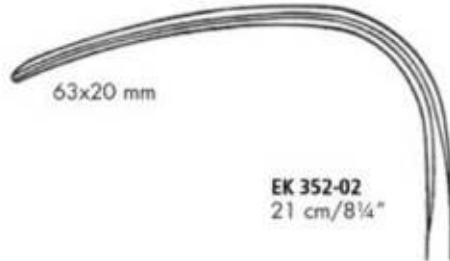

63x20 mm

EK 352-02
21 cm/8¼"



55x20 mm

EK 352-01
22 cm/8¼"



1/2
LANGENBECK
22 cm/8¼"



EK 353-01
30 x 11 mm

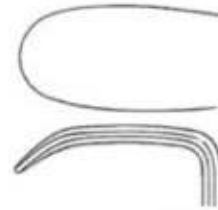

EK 353-02
30 x 16 mm



EK 353-03
30 x 14 mm

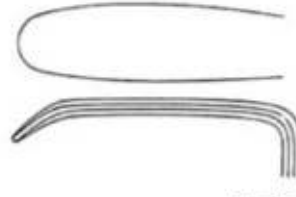

EK 353-04
40 x 11 mm

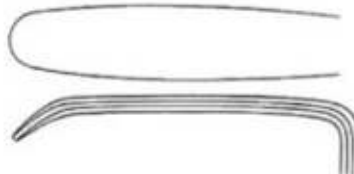

EK 353-05
50 x 11 mm

Ekartörler
Retractors
Wundhaken



KOCHER-LANGENBECK
22 cm/8½"



EK 355-01
25x6 mm



EK 355-02
35x8 mm



EK 355-03
35x11 mm



EK 355-04
35x15 mm



EK 355-05
40x11 mm



EK 355-06
55x11 mm



EK 355-07
70x14 mm



EK 355-08
80x12 mm



EK 355-09
80x16 mm



KOCHER
23 cm/9"

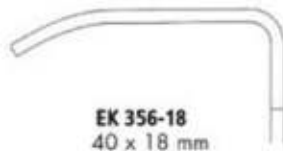

EK 356-18
40 x 18 mm



EK 356-20
60 x 20 mm

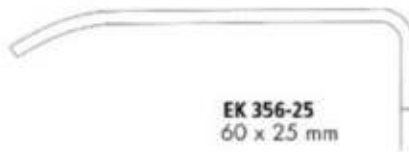

EK 356-25
60 x 25 mm



EK 356-30
75 x 30 mm



EK 356-40
78 x 40 mm



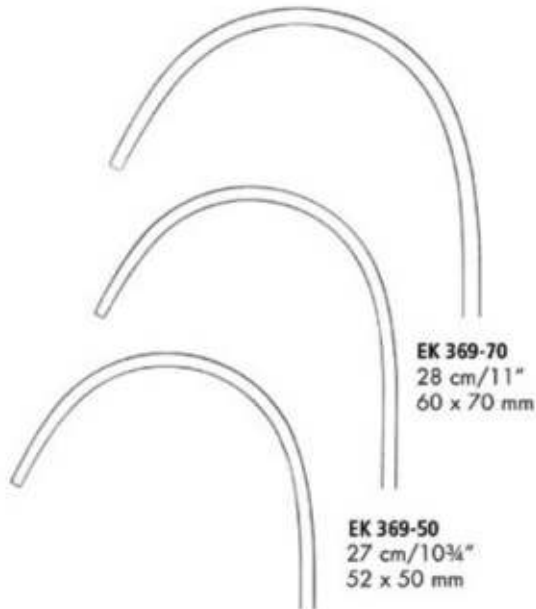

EK 369-45
27 cm/10
48 x 45 mm



MIDDELDORPF

Fig. 2 = 49 x 38 mm
Fig. 1 = 28 x 20 mm

EK 372-01
26 cm/10¼"
Fig. 1

EK 372-02
27 cm/10¾"
Fig. 2

Fig. 1 = 36 x 28 mm
Fig. 2 = 63 x 49 mm



RICHARDSON
EK 372-00
Fig. 1 - 2

Fig. 2 = 25 x 24 mm
Fig. 1 = 21 x 24 mm

Fig. 1 = 40 x 15 mm
Fig. 2 = 45 x 15 mm



US Army (PARKER-LANGENBECK)
EK 401-00
21 cm/8¼"
Fig. 1 - 2



RICHARDSON
24 cm/9½"

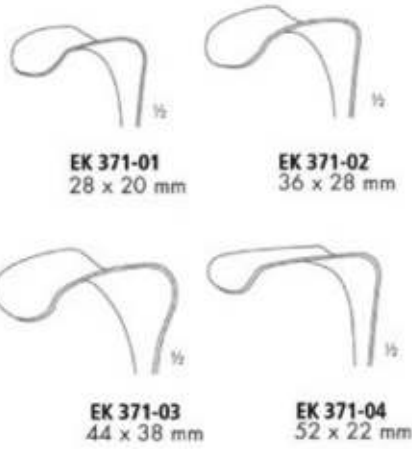

EK 371-01
28 x 20 mm

EK 371-02
36 x 28 mm

EK 371-03
44 x 38 mm

EK 371-04
52 x 22 mm

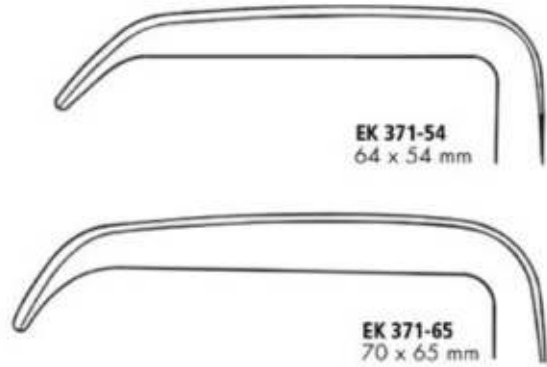

EK 371-54
64 x 54 mm

EK 371-65
70 x 65 mm



KELLY
26 cm/10¼"



FRITSCH



EK 374-60
41 x 60 mm



EK 374-50
34 x 50 mm

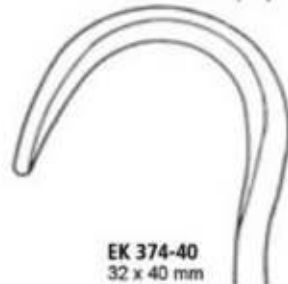

EK 374-40
32 x 40 mm

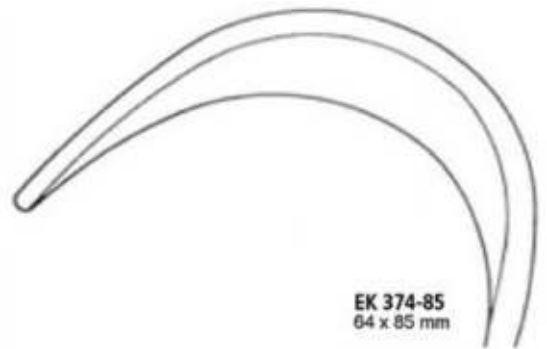

EK 374-85
64 x 85 mm

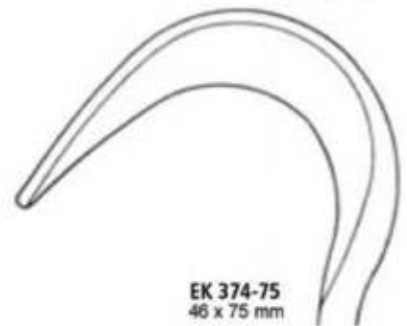

EK 374-75
46 x 75 mm

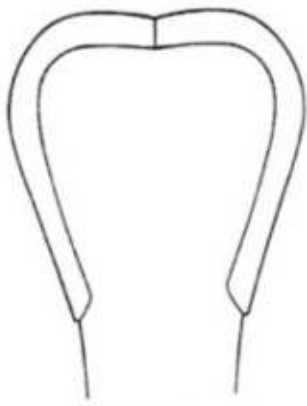

EK 379-40
123x45 mm



EK 379-62
123x64 mm



EK 379-64
175x64 mm



1/2

HARRINGTON
29,5 cm/11½"

Ekartörler
Retractors
Wundhaken

idOL
CERRAHİ ALETLER
www.idolcerrahi.com



MIKULICZ

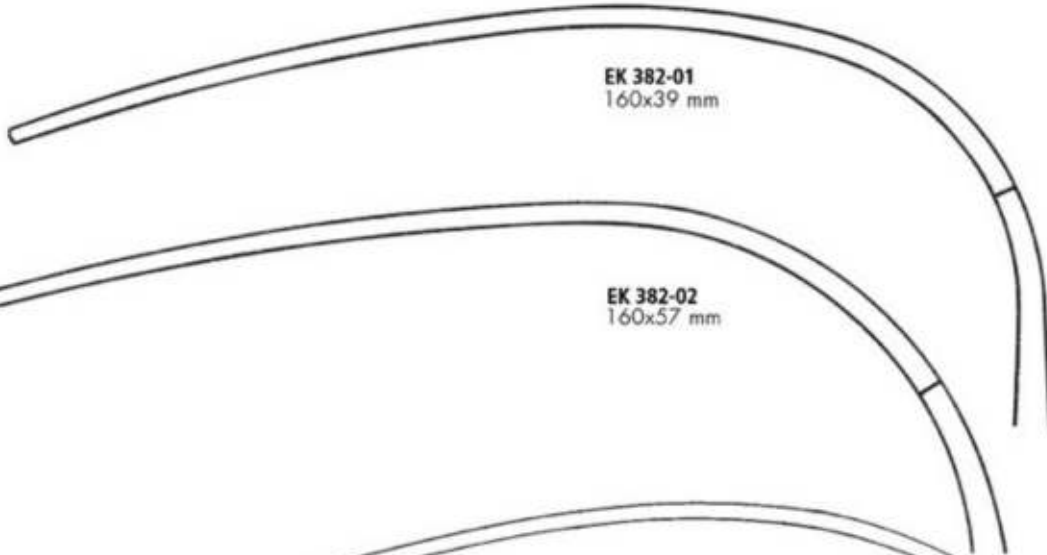

EK 382-01
160x39 mm

EK 382-02
160x57 mm



EK 382-03
190x39 mm

EK 382-04
190x57 mm

½

KELLY
26 cm/10¼"

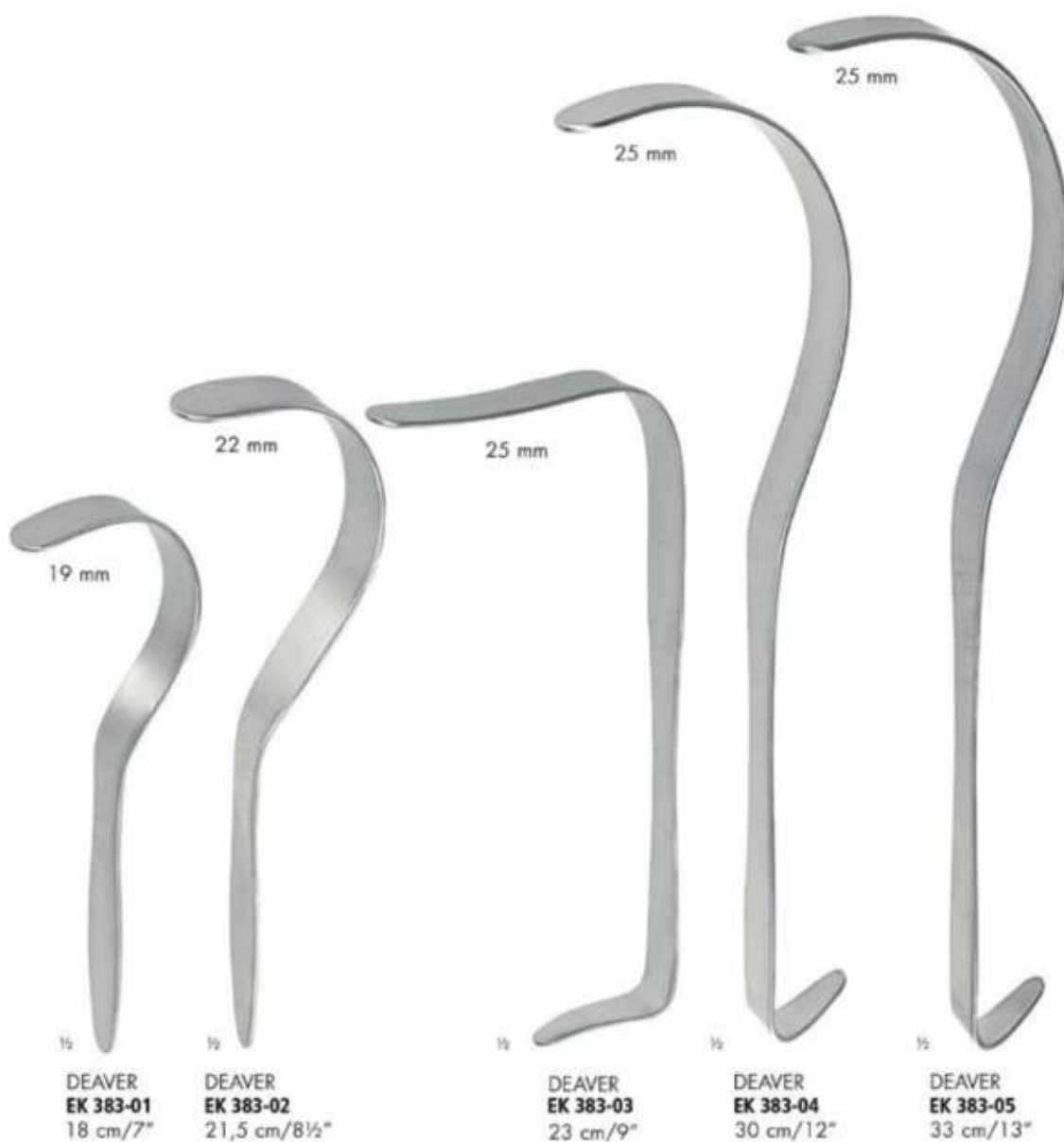



Ekartörler
Retractors
Wundhaken



EK 385-01
25 mm

EK 385-02
38 mm

EK 385-03
50 mm

EK 385-04
75 mm

EK 385-05
100 mm



120 x 47 mm

KOERTE
EK 386-28
28 cm/11"



malleable

30 mm	EK 387-30
40 mm	EK 387-40
50 mm	EK 387-50
60 mm	EK 387-60
70 mm	EK 387-70



41 cm/16"





EK 391-22
82 x 22 mm



EK 391-38
115 x 38 mm



EK 391-65
115 x 65 mm



1/2

CORYLLOS
24 cm/9½"



EK 391-22
82 x 22 mm



EK 391-38
115 x 38 mm



EK 391-65
115 x 65 mm



3/5

CORYLLOS
24 cm/9½"



ROUX
EK 396-00
Set complete, Fig. 1 - 3

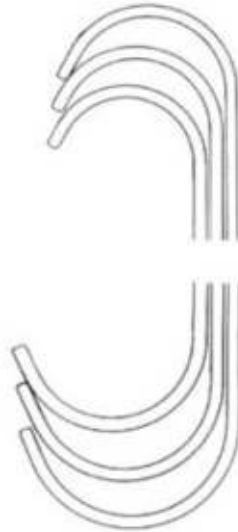

Fig. 1	14 cm/5½"	EK 396-01	24 x 20 / 30 x 28 mm
Fig. 2	15 cm/6"	EK 396-02	29 x 26 / 36 x 36 mm
Fig. 3	17 cm/6¾"	EK 396-03	33 x 29 / 38 x 43 mm



ROUX
EK 396-04
17 cm/6¾"



FARABEUF
EK 397-00
12 cm/4¾"
Fig. 1 - 2

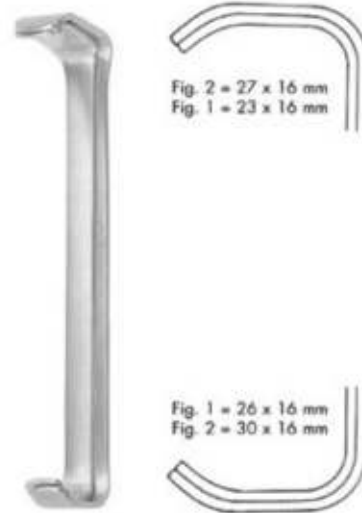

FARABEUF
EK 397-05
15 cm/6"
Fig. 1 - 2



FINSER

2 x 3



EK 420-05
5 cm/2"
sharp

2 x 3



EK 421-05
5 cm/2"
blunt

3 x 4



EK 420-07
7 cm/2¾"
sharp

3 x 4



EK 421-07
7 cm/2¾"
blunt



1/2

ALM



EK 424-07
7 cm/2¾"
sharp



EK 424-10
10 cm/4"
sharp



EK 425-07
7 cm/2¾"
blunt



EK 425-10
10 cm/4"
blunt



1/2

ALLPORT
EK 424-95
9,5 cm/3¾"



1/2

WEITLANER



EK 435-10
11,5 cm/4½"
2 : 3
sharp

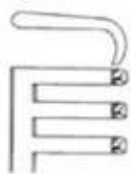

EK 436-10
11,5 cm/4½"
2 : 3
blunt

Otomatik Ekartörler
Self-Retaining Retractors
Wundspreizer



WEITLANER



EK 435-13
13 cm/4¼"
3 : 4
sharp

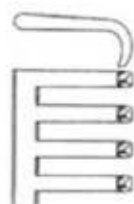

EK 436-13
13 cm/4¼"
3 : 4
blunt

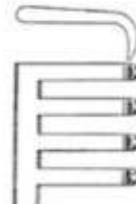

EK 435-16
16,5 cm6½"
3 : 4
sharp



EK 436-16
16,5 cm6½"
3 : 4
blunt



WEITLANER

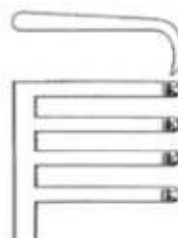

EK 435-20
20 cm/8"
3 : 4
sharp

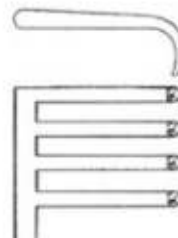

EK 436-20
20 cm/8"
3 : 4
blunt

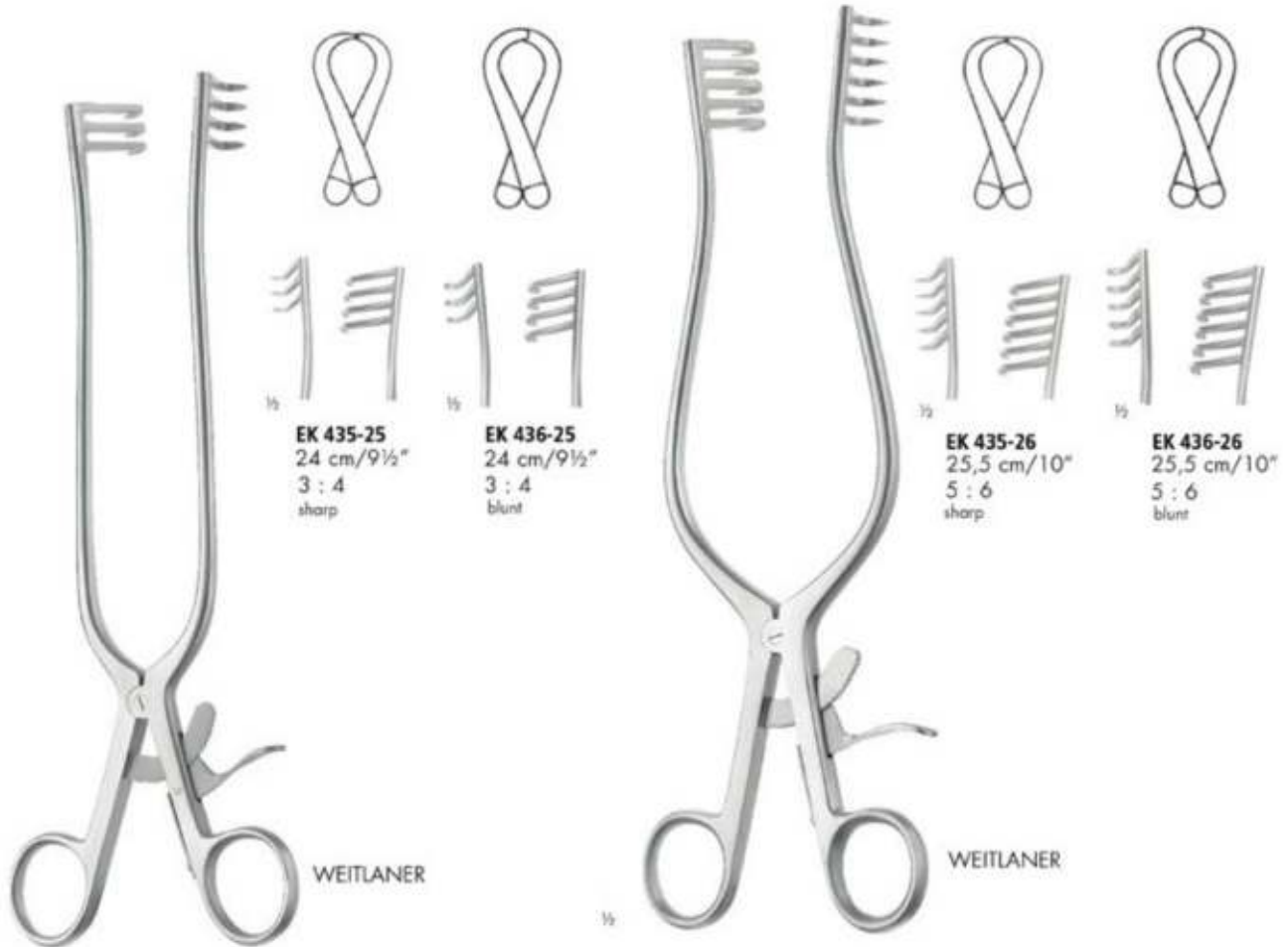

EK 435-25
 24 cm/9½"
 3 : 4
 sharp

EK 436-25
 24 cm/9½"
 3 : 4
 blunt

EK 435-26
 25,5 cm/10"
 5 : 6
 sharp

EK 436-26
 25,5 cm/10"
 5 : 6
 blunt

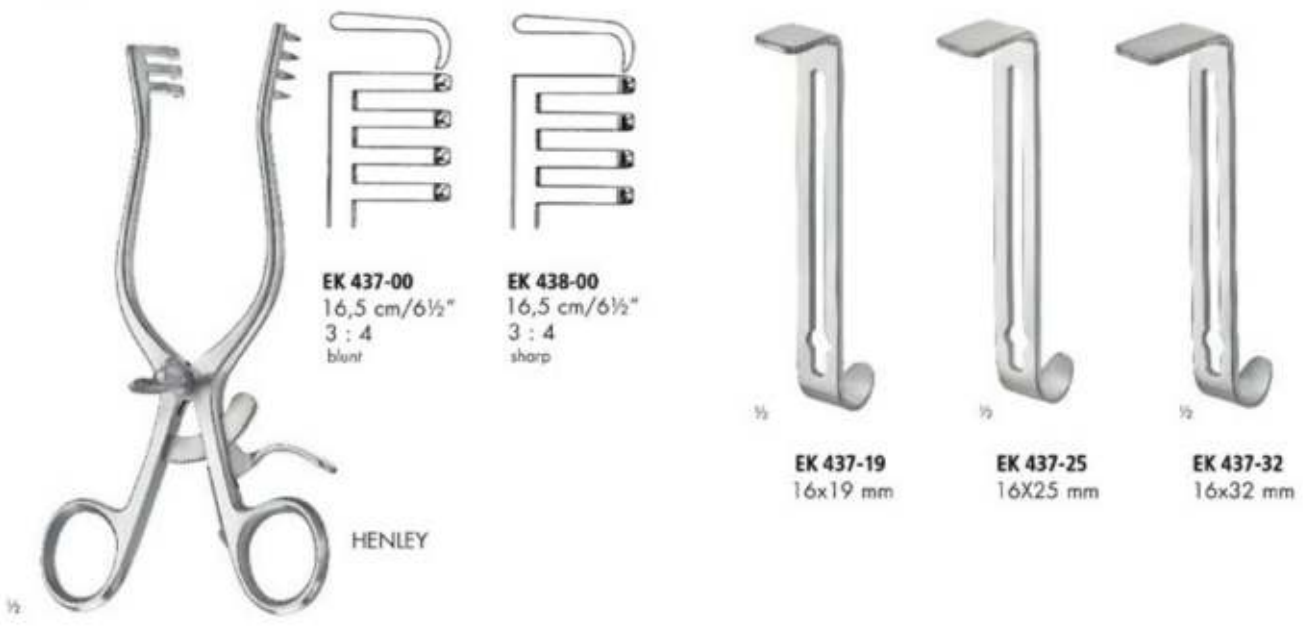

EK 437-00
 16,5 cm/6½"
 3 : 4
 blunt

EK 438-00
 16,5 cm/6½"
 3 : 4
 sharp

EK 437-19
 16x19 mm

EK 437-25
 16x25 mm

EK 437-32
 16x32 mm

Otomatik Ekartörler
Self-Retaining Retractors
Wundspreizer

idOL
CERRAHİ ALETLER
www.idolcerrahi.com



BECKMANN

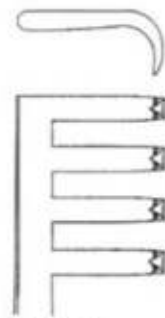

EK 460-31
31 cm/30½"
4 : 4
sharp



BECKMANN-ADSON

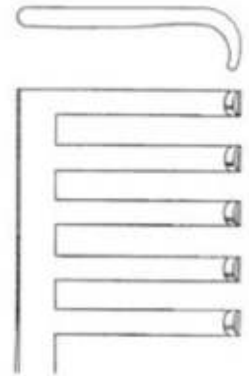

EK 463-33
32 cm/12¾"
4 : 5
blunt



BALFOUR
EK 492-25
25 cm/10"



SELLORS
EK 717-00
20 cm/8"



BAILEY
EK 717-15
15,5 cm/6"



BAILEY
EK 718-01
20 cm/8"



BAILEY-GIBBON
EK 718-02
20 cm/8"

Akciger Spatulları
Lung Spatulas
Lungenspatel

idOL
CERRAHİ ALETLER
www.idolcerrahi.com



EK 720-25
30 cm/12"
40 mm

EK 720-32
32 cm/12¾"
54 mm

ALLISON



EK 721-30
30 cm/12"
137 mm



KA 220-01
17x21 mm



KA 220-04
24x27 mm



KA 220-02
16x23 mm



KA 220-05
28x20 mm



KA 220-03
20x25 mm



KA 220-06
28x29 mm

Atrium Ekartörleri
Atrium Retractors
Atriumhaken

idOL
CERRAHİ ALETLER
www.idolcerrahi.com



COOLEY
KA 225-01
25 cm/9¾"
48x48 mm
right



COOLEY
KA 225-02
25 cm/9¾"
48x48 mm
right, serrated



COOLEY
KA 225-03
27,5 cm/10¾"
30x48 mm
left



3/4
COOLEY modif. STRUCK
KA 225-04
25 cm/9¾"
45x35 mm
serrated



3/4
COOLEY modif. STRUCK
KA 225-05
25 cm/9¾"
45x30 mm
serrated

Diseksiyon Pensetleri
Dissecting Forceps
Anatomische Pinzetten



11,5 cm/4½"	FO 100-11	FO 120-11
13 cm/5"	FO 100-13	FO 120-13
14,5 cm/5¾"	FO 100-14	FO 120-14
16 cm/6¼"	FO 100-16	FO 120-16
18 cm/7"	FO 100-18	FO 120-18
20 cm/8"	FO 100-20	FO 120-20
25 cm/10"	FO 100-25	FO 120-25
30 cm/12"	FO 100-30	FO 120-30



14,5 cm/5¾"	FO 399-14
16 cm/6¼"	FO 399-16



POTTS-SMITH

15,5 cm/6"		FO 400-15
18 cm/7"	FO 350-18	FO 400-18
20 cm/8"		FO 400-20
21 cm/8¼"	FO 350-21	
23 cm/9"		FO 400-23
25 cm/10"	FO 350-25	FO 400-25



11,5 cm/4½"	FO 110-11	FO 130-11
13 cm/5"	FO 110-13	FO 130-13
14,5 cm/5¾"	FO 110-14	FO 130-14
16 cm/6¼"	FO 110-16	FO 130-16
18 cm/7"	FO 110-18	FO 130-18
20 cm/8"	FO 110-20	FO 130-20
25 cm/10"	FO 110-25	FO 130-25
30 cm/12"	FO 110-30	FO 130-30



11,5 cm/4½"	FO 111-11
13 cm/5"	FO 111-13
14,5 cm/5¾"	FO 111-14
16 cm/6¼"	FO 111-16
18 cm/7"	FO 111-18
20 cm/8"	FO 111-20
25 cm/10"	FO 111-25

1:2



POTTS-SMITH

18 cm/7"	FO 360-18
21 cm/8¼"	FO 360-21
25 cm/10"	FO 360-25



ADSON

12 cm/4¾"	FO 200-12	FO 405-12
15 cm/6"	FO 200-15	FO 405-15
18 cm/7"	FO 200-18	



ADSON micro

12 cm/4¾"	FO 201-12
15 cm/6"	FO 201-15



ADSON

12 cm/4¾"	FO 202-12	FO 406-12
15 cm/6"	FO 202-15	FO 406-15
18 cm/7"	FO 202-18	



ADSON micro

12 cm/4¾"	FO 203-12
15 cm/6"	FO 203-15

Diseksiyon Pensetleri
Dissecting Forceps
Anatomische Pinzetten



SEMKEN
 12,5 cm/5" **FO 226-12**
 15,5 cm/6" **FO 226-15**



SEMKEN
 12,5 cm/5" **FO 228-12**
 15,5 cm/6" **FO 228-15**



GILLIES
FO 510-15
 15,5 cm/6"



GILLIES
FO 403-15
 15,5 cm/6"



GERALD



FO 300-18
 18 cm/7"



FO 301-18
 18 cm/7"



FO 300-23
 23 cm/9"



GERALD



FO 310-18
 18 cm/7"



FO 311-18
 18 cm/7"



FO 310-23
 23 cm/9"

1:2



CUSHING
FO 320-17
17 cm/6 $\frac{3}{4}$ "



CUSHING
FO 325-17
17 cm/6 $\frac{3}{4}$ "



CUSHING
17 cm/6 $\frac{3}{4}$ "



FO 407-17



FO 408-17



CUSHING-TAYLOR
FO 409-18
18 cm/7"



LUCAE
FO 703-14
14 cm/5 $\frac{1}{2}$ "



JANSEN
FO 705-16
16 cm/6 $\frac{1}{4}$ "



ADSON
FO 705-18
17,5 cm/7"

Diseksiyon Pensetleri
Dissecting Forceps
Anatomische Pinzetten



McINDOE
 15 cm/6"

FO 225-15



SINGLY
 23 cm/9"

FO 502-23



NELSON
 23 cm/9"

FO 503-23



WANGENSTEEN
 15,5 cm/6" **FO 413-15**
 23 cm/9" **FO 413-23**



Russ. Mod.



FO 517-15
 15 cm/6"



FO 517-20
 20 cm/8"



FO 517-25
 25 cm/10"



DURANTE



FO 518-14
 14 cm/5 3/4"



FO 518-16
 16 cm/6 1/4"



FO 518-20
 20 cm/8"



LAZAR
15,5 cm/6"



18,5 cm/7¼"



AUSTIN
14 cm/5½"



Mikro Pensetler , Kuyumcu tipi
Micro Forceps , Jeweler types
Mikro-Pinzetten Uhrmacher-Modelle



FO 530-00
12 cm/4¼"
Fig. 1



FO 530-01
12 cm/4¼"
Fig. 2



FO 530-02
11 cm/4¼"
Fig. 3



FO 530-03
11 cm/4¼"
Fig. 4



FO 530-04
11 cm/4¼"
Fig. 5



FO 530-07
11 cm/4¼"
Fig. 5



FO 530-05
11 cm/4¼"
Fig. 5a



FO 530-11
12 cm/4¼"
Fig. 7

ATRAUMA



DE BAKEY



DE BAKEY

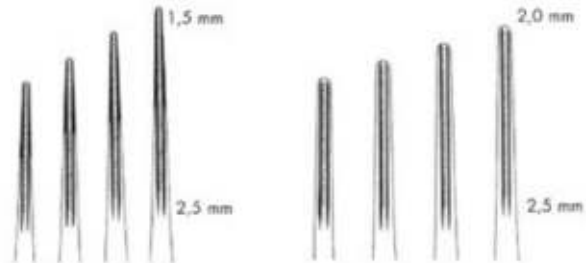

16 cm/6¼"	FO 950-16	FO 951-16
20 cm/8"	FO 950-20	FO 951-20
24 cm/9½"	FO 950-24	FO 951-24
30 cm/12"		FO 951-30



16 cm/6¼"	FO 952-16	FO 953-16
20 cm/8"	FO 952-20	FO 953-20
24 cm/9½"	FO 952-24	FO 953-24
30 cm/12"	FO 952-30	FO 953-30

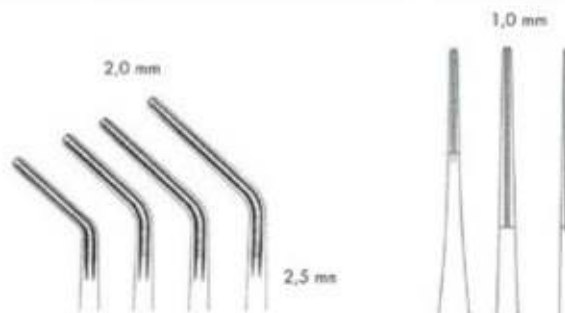

16 cm/6¼"	FO 954-16	FO 960-15
20 cm/8"	FO 954-20	FO 960-20
24 cm/9½"	FO 954-24	FO 960-24
30 cm/12"	FO 954-30	

Atravmatik Pensetler
Atraumatic Tissue Forceps
Atraumatische Pinzetten

ATRAUMA



ULTRA-LIGHT

1,2 mm

1,5 mm



FO 970-15
15 cm/6"

FO 970-20
20 cm/8"

1,5 mm

1,5 mm



FO 970-24
24 cm/9½"

FO 970-30
30 cm/12"



DE BAKEY-ADSON
12 cm/4¾" **FO 975-12**
15 cm/6" **FO 975-15**

Titanium

ATRAUMA



DE BAKEY



DE BAKEY



15 cm/6"	FO 980-15	FO 981-15
20 cm/8"	FO 980-20	FO 981-20
24 cm/9½"	FO 980-24	FO 981-24



15 cm/6"	FO 982-15	FO 983-15	FO 984-15
20 cm/8"	FO 982-20	FO 983-20	FO 984-20
24 cm/9½"	FO 982-24	FO 983-24	FO 984-24
30 cm/12"	FO 982-30	FO 983-30	FO 984-30



15 cm/6"	FO 985-15	FO 986-15
20 cm/8"	FO 985-20	FO 986-20
24 cm/9½"	FO 985-24	FO 986-24
30 cm/12"	FO 985-30	FO 986-30

Bulldog Klempler
Bulldog Clamps
Bulldogklemmen

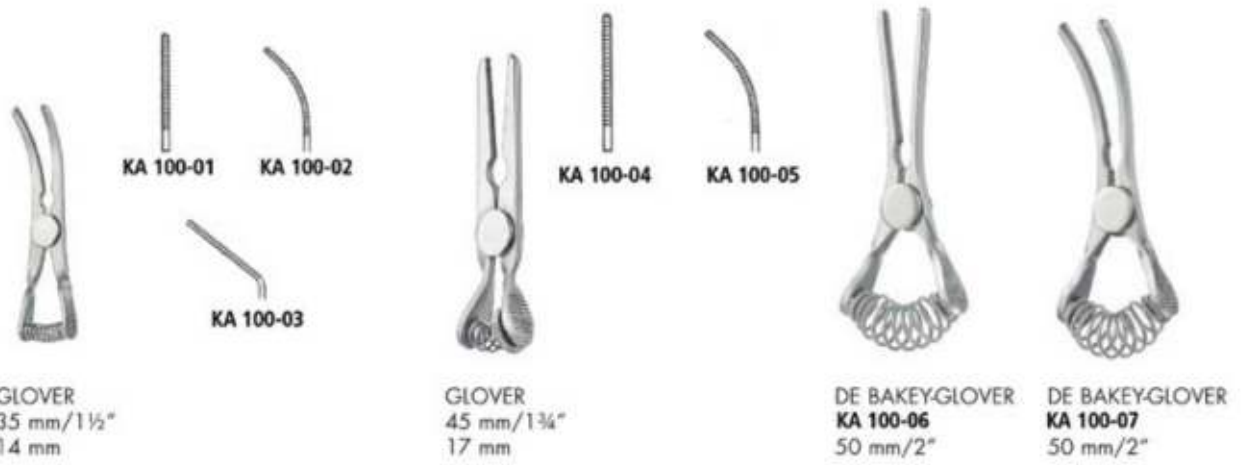

ATRAUMA



DE BAKEY

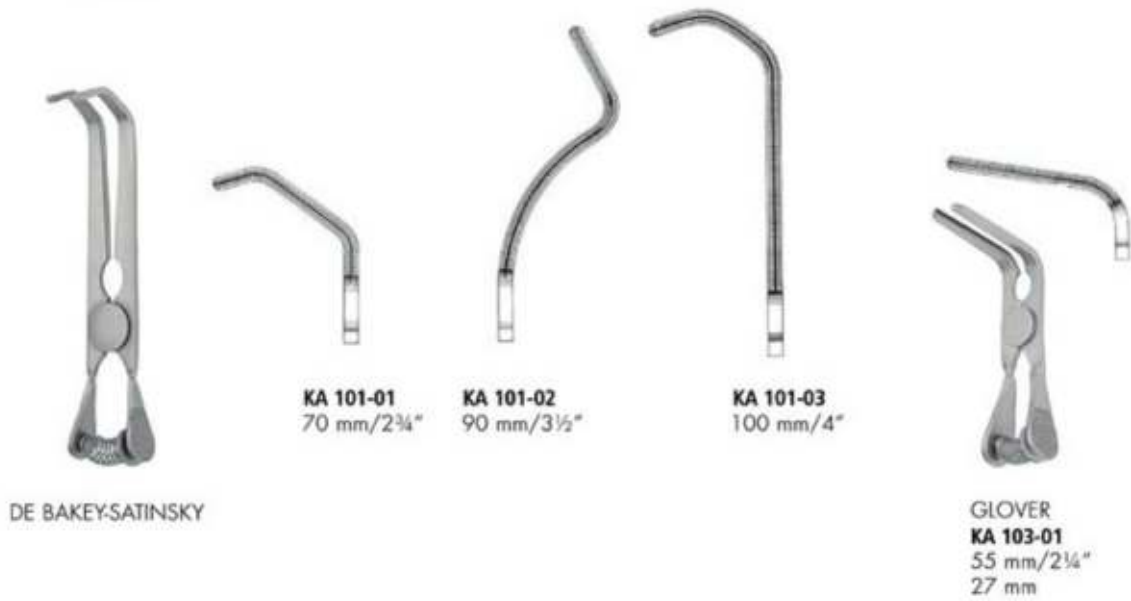

ATRAUMA



DE BAKEY



KA 102-01
70 mm/2½"
20 mm



KA 102-02
80 mm/3"
30 mm



KA 102-03
95 mm/3½"
43 mm



KA 102-04
115 mm/4½"
56 mm



GLOVER



KA 103-01
65 mm/2½"
20 mm



KA 103-02
75 mm/2¾"
30 mm



KA 103-03
85 mm/3½"
43 mm



KA 103-04
105 mm/4½"
56 mm

Bulldog Klempler
Bulldog Clamps
Bulldogklemmen

ATRAUMA



DE BAKEY



KA 105-01
80 mm/3"
20 mm



KA 105-02
90 mm/3½"
30 mm



KA 105-03
105 mm/4¼"
45 mm



KA 105-04
125 mm/4¾"
68 mm



DE BAKEY



KA 106-01
75 mm/2¾"
20 mm



KA 106-02
85 mm/3¼"
30 mm



KA 106-03
95 mm/3½"
45 mm



KA 106-04
115 mm/4½"
68 mm



— DIEFFENBACH —

35 mm/1½"	HM 476-03	HM 477-03
50 mm/2"	HM 476-05	HM 477-05



— DIEFFENBACH —

58 mm/2¼"	HM 476-06	HM 477-06
-----------	-----------	-----------



— JOHN-HOPKINS —

50 mm/2"	HM 480-05	HM 481-05
65 mm/2½"	HM 480-06	HM 481-06
75 mm/3"	HM 480-07	HM 481-07
90 mm/3½"	HM 480-09	HM 481-09



HM 480-00
 23 cm/8¼"

Hemostatik Pensler
Haemostatic Forceps
Arterienklemmen

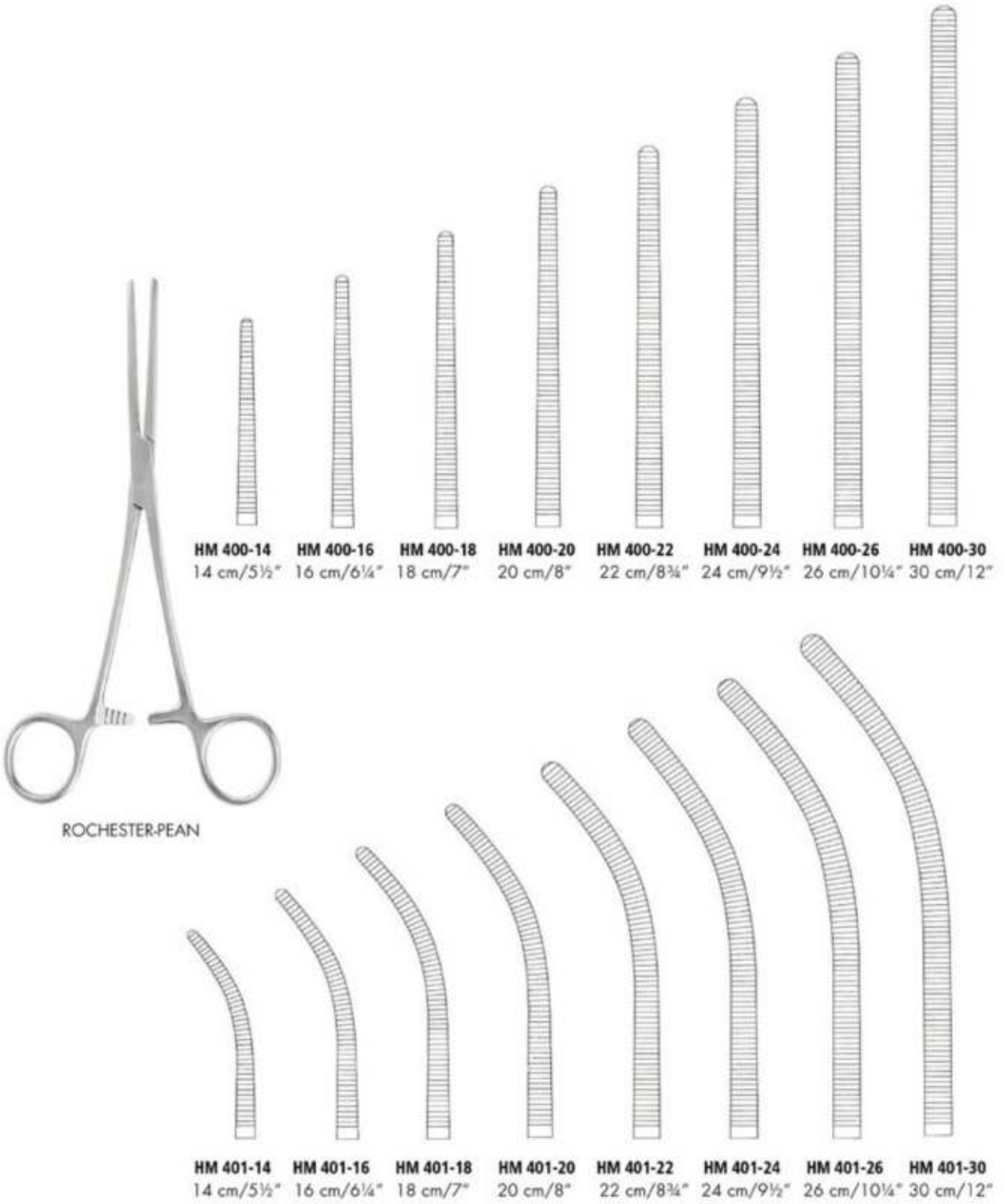



ROCHESTER-OCHSNER

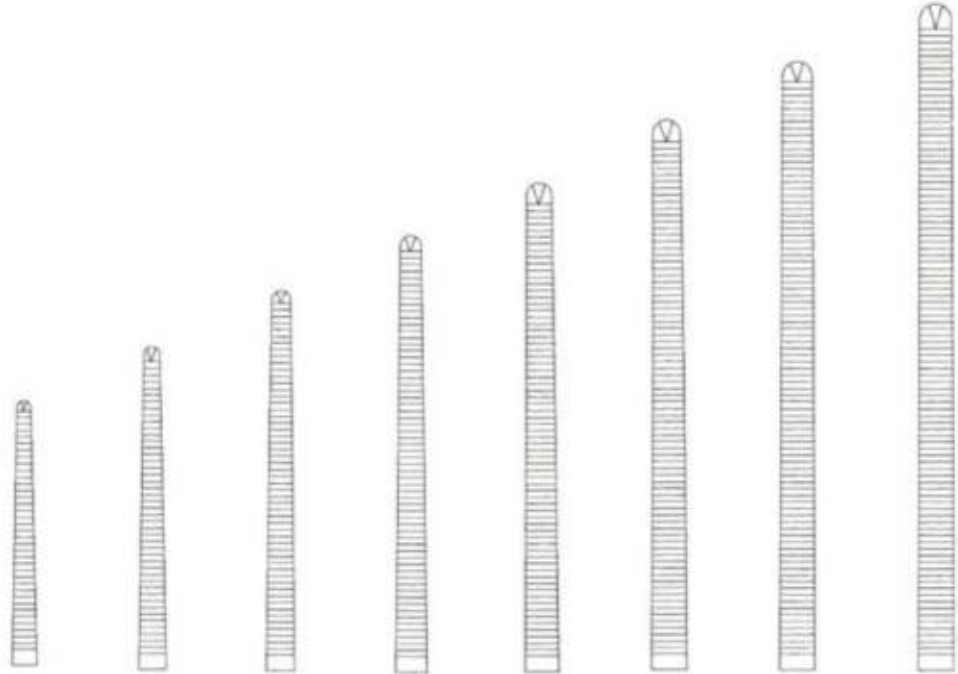

HM 405-14	HM 405-16	HM 405-18	HM 405-20	HM 405-22	HM 405-24	HM 405-26	HM 405-30
14 cm/5½"	16 cm/6¼"	18 cm/7"	20 cm/8"	22 cm/8¾"	24 cm/9½"	26 cm/10¼"	30 cm/12"

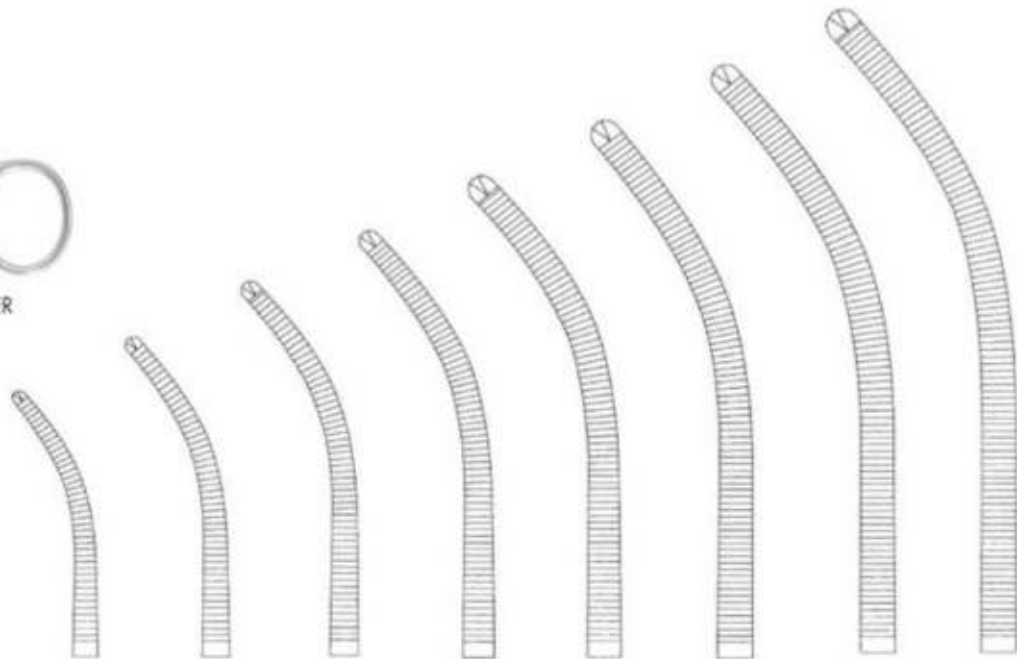

HM 406-14	HM 406-16	HM 406-18	HM 406-20	HM 406-22	HM 406-24	HM 406-26	HM 406-30
14 cm/5½"	16 cm/6¼"	18 cm/7"	20 cm/8"	22 cm/8¾"	24 cm/9½"	26 cm/10¼"	30 cm/12"

Organ ve Doku Klempleri
Organ and Tissue Grasping Forceps
Organ- und Gewebefaßzangen



ALLIS-BABY
HM 400-13
 13 cm/5"



ALLIS



15 cm/6" **HM 401-15**
 19 cm/7½" **HM 401-19**
 24 cm/9½" **HM 401-25**

ATRAUMA



DE BAKEY



ALLIS-Atrauma



HM 370-15 16 cm/6¼"
HM 370-20 20 cm/8"



HM 370-25 25 cm/10"
HM 370-30 30 cm/12"



JUDD-ALLIS
HM 390-15
 15 cm/6"



THOMS-ALLIS
HM 390-20
 20 cm/8"





BABCOCK



HM 410-16
16 cm/6¼"



HM 410-18
18 cm/7"



HM 410-20
20 cm/8"



HM 410-24
24 cm/9½"



BABCOCK-Atrauma



HM 371-16
16 cm/6¼"



HM 371-21
20 cm/8"

ATRAUMA



DE BAKEY

Hemostatik Pensler
Haemostatic Forceps
Arterienklemmen

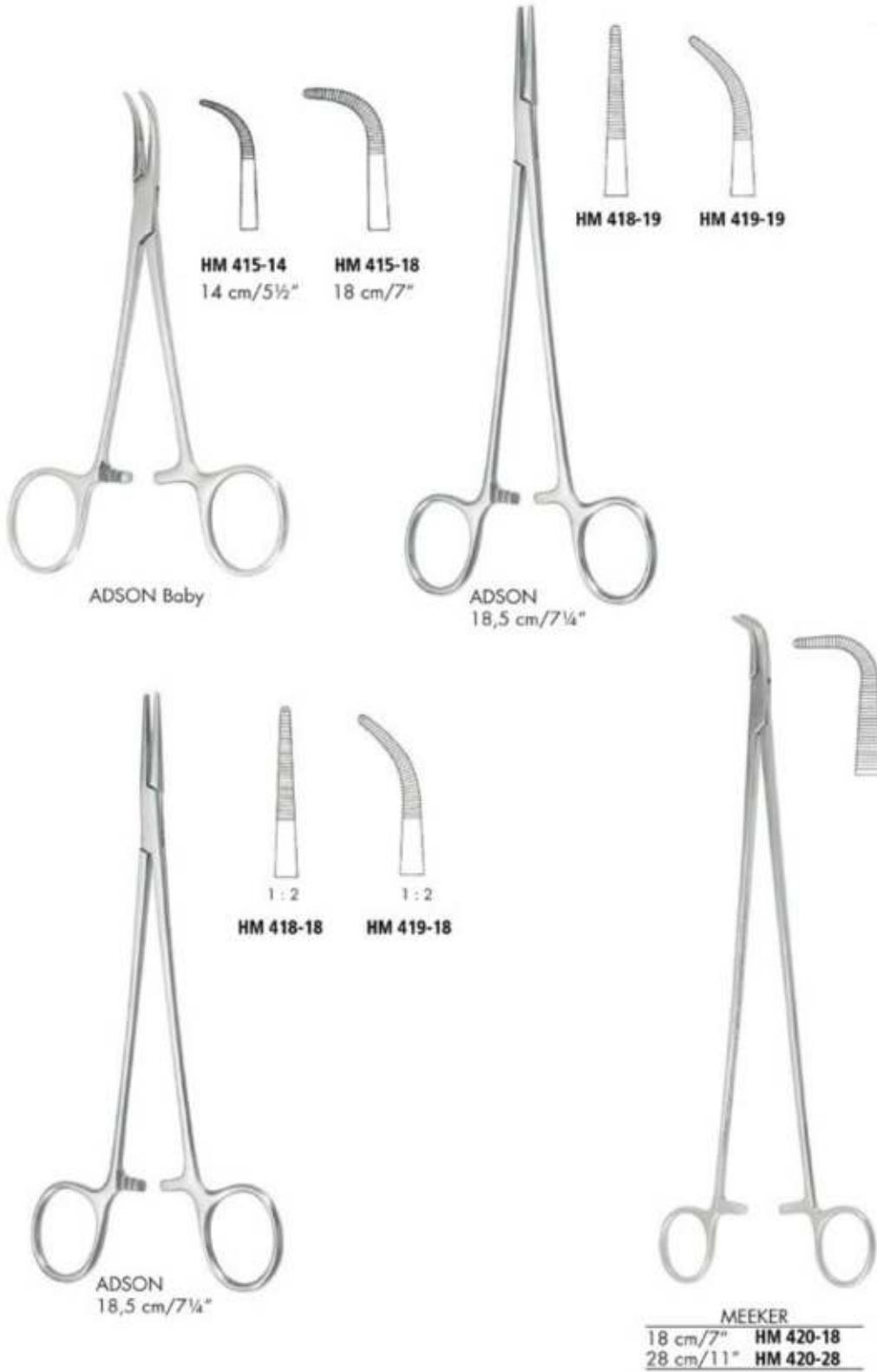

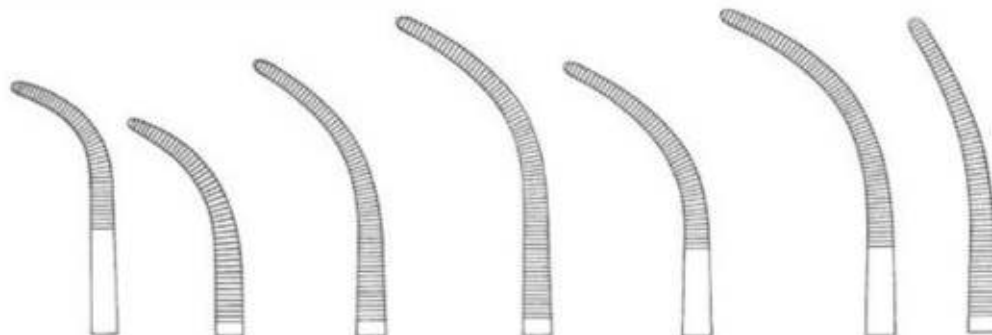

HM 420-01 21 cm/8¼"
HM 420-02 21 cm/8¼"
HM 420-03 21 cm/8¼"
HM 422-04 21 cm/8¼"
HM 422-05 21 cm/8¼"
HM 422-06 21 cm/8¼"
HM 422-07 21 cm/8¼"

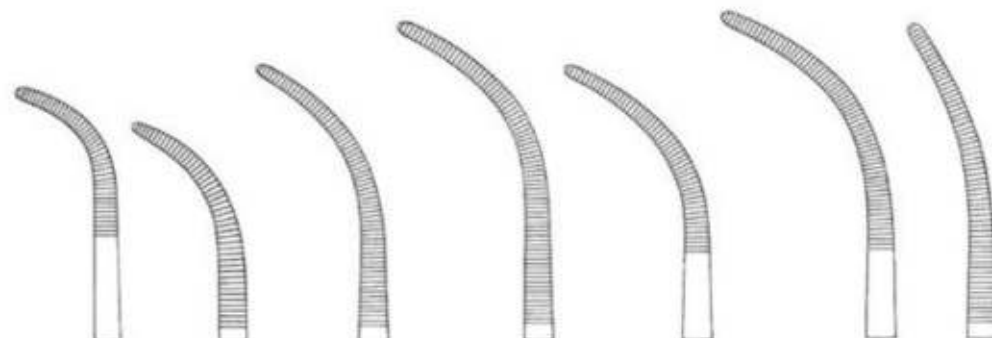

HM 421-01 27 cm/10¾"
HM 421-02 27 cm/10¾"
HM 421-03 27 cm/10¾"
HM 423-04 27 cm/10¾"
HM 423-05 27 cm/10¾"
HM 423-06 27 cm/10¾"
HM 423-07 27 cm/10¾"



OVERHOLT-GEISSENDOERFER



OVERHOLT-BABY
HM 424-13
 13,5 cm/5¼"

Hemostatik Pensler
Haemostatic Forceps
Arterienklemmen

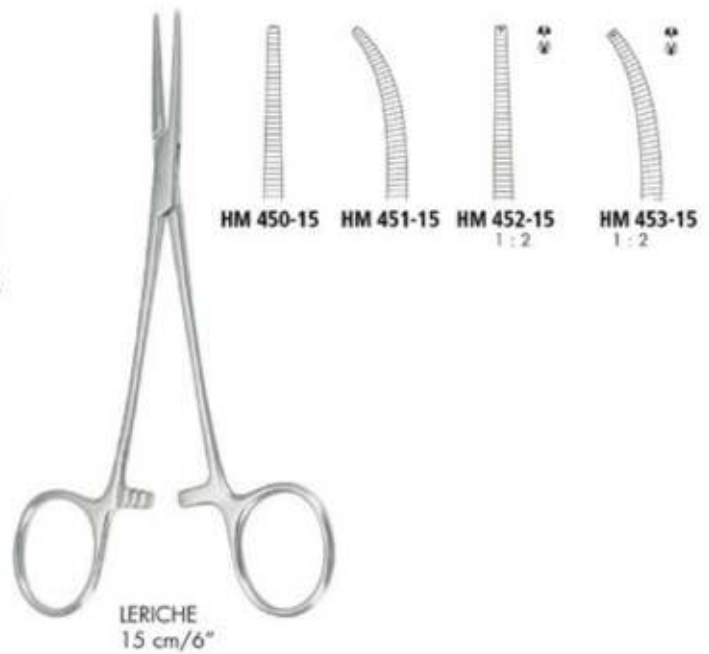
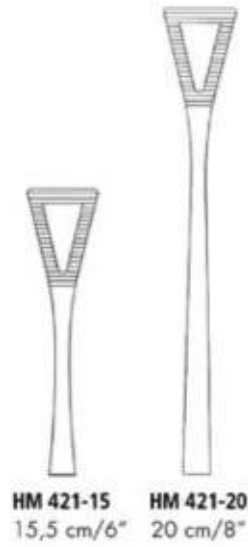



OVERHOLT

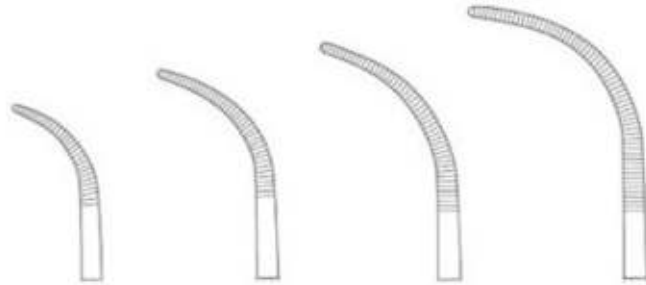

HM 426-18
18,5 cm/7¼"

HM 426-20
20,5 cm/8"

HM 426-21
21,0 cm/8¼"

HM 426-22
21,5 cm/8½"



SCHNIDT
19 cm/7½"



HM 430-01 **HM 430-02**



CRAFOORD SELLORS
24 cm/9½"

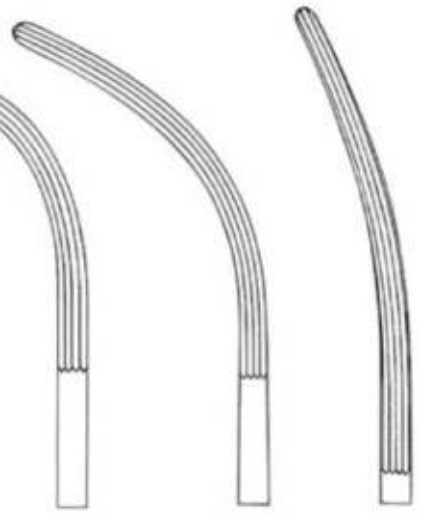

HM 500-22

HM 500-23

HM 500-24

Hemostatik Pensler
Haemostatic Forceps
Arterienklemmen



PEAN
Delicate pattern



HM 427-13
13 cm/5"



HM 427-14
14 cm/5½"



HM 427-16
16 cm/6¼"



HM 428-13
13 cm/5"



HM 428-14
14 cm/5½"



HM 428-16
16 cm/6¼"



KOCHER
1 : 2
Delicate pattern



HM 429-13
13 cm/5"



HM 429-14
14 cm/5½"



HM 429-16
16 cm/6¼"



HM 432-13
13 cm/5"



HM 432-14
14 cm/5½"



HM 432-16
16 cm/6¼"



SPENCER-WELLS

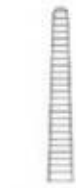

HM 430-13
 13 cm/5"



HM 430-14
 14 cm/5½"



HM 430-15
 15 cm/6"



HM 430-18
 18 cm/7"



HM 430-20
 20 cm/8"



HM 431-13
 13 cm/5"



HM 431-14
 14 cm/5½"



HM 431-15
 15 cm/6"



HM 431-18
 18 cm/7"



HM 431-20
 20 cm/8"



ROCHESTER-CARMALT



HM 440-16
 16 cm/6¼"



HM 440-20
 20 cm/8"



HM 441-16
 16 cm/6¼"



HM 441-20
 20 cm/8"

Hemostatik Pensler
Haemostatic Forceps
Arterienklemmen



HARTMANN
 10 cm/4"

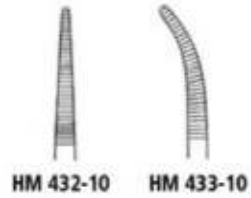

HALSTED-MOSQUITO micro

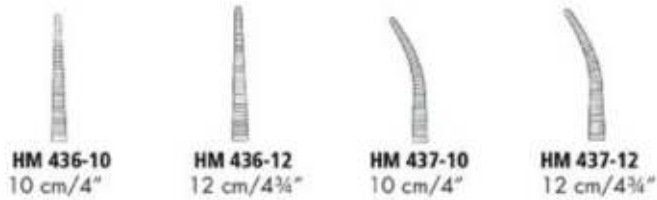

HM 436-10
 10 cm/4"

HM 436-12
 12 cm/4¾"

HM 437-10
 10 cm/4"

HM 437-12
 12 cm/4¾"

1:2

1:2

1:2

1:2



HM 438-10
 10 cm/4"



HM 438-12
 12 cm/4¾"



HM 439-10
 10 cm/4"



HM 439-12
 12 cm/4¾"



HALSTED-MOSQUITO

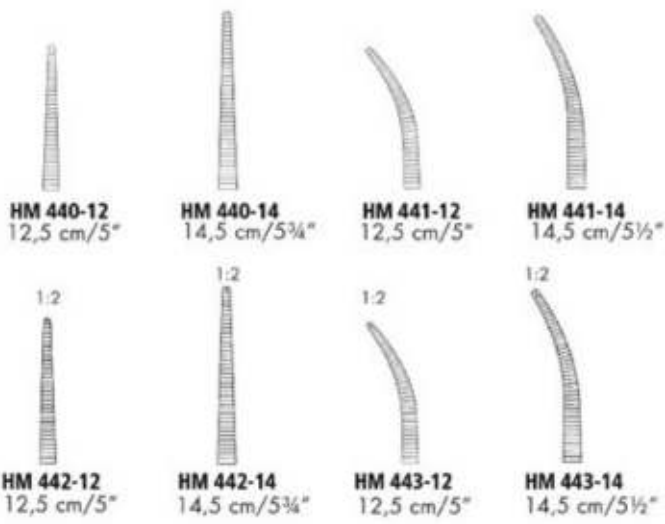

HM 440-12
 12,5 cm/5"

HM 440-14
 14,5 cm/5¾"

HM 441-12
 12,5 cm/5"

HM 441-14
 14,5 cm/5½"



HM 442-12
 12,5 cm/5"



HM 442-14
 14,5 cm/5¾"



HM 443-12
 12,5 cm/5"



HM 443-14
 14,5 cm/5½"

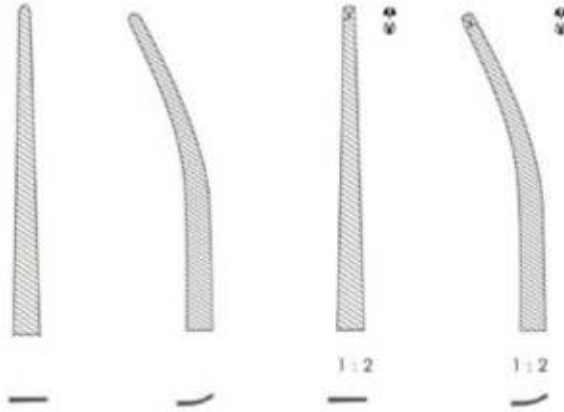

20 cm/8"	HM 444-20	HM 445-20	HM 446-20	HM 447-20
26 cm/10¼"	HM 444-26	HM 445-26	HM 446-26	HM 447-26

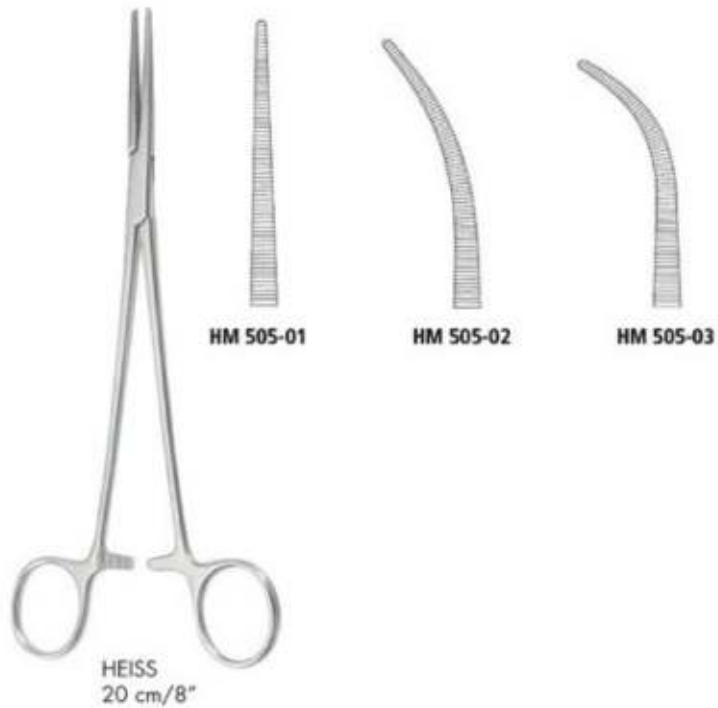

Hemostatik Pensler
Haemostatic Forceps
Arterienklemmen

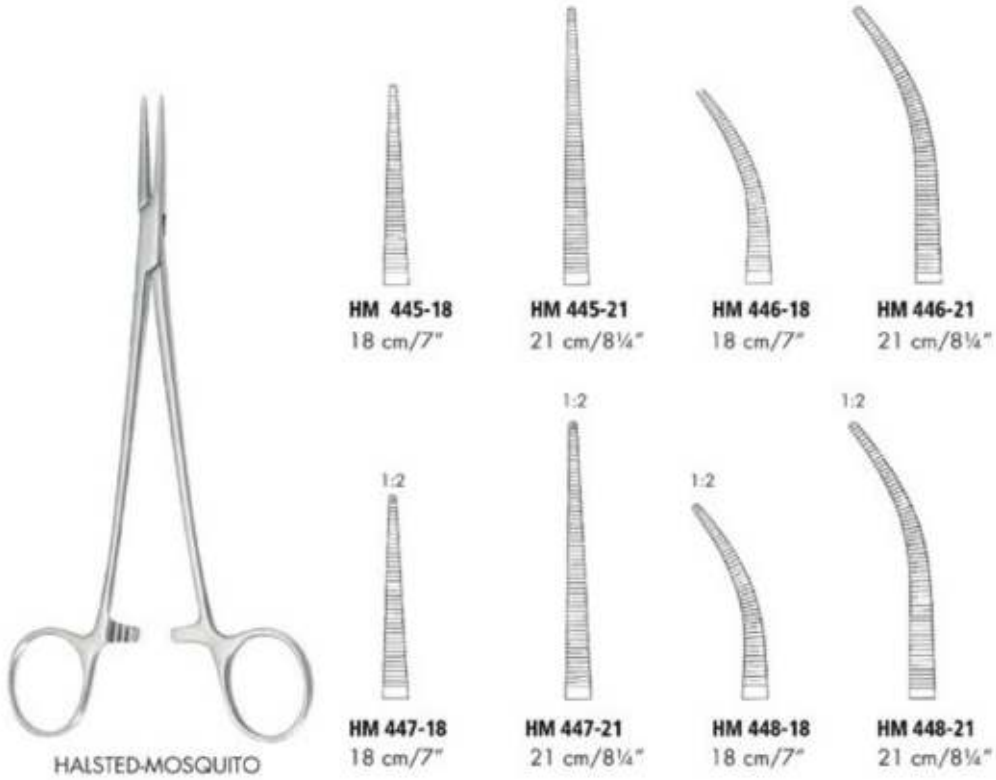

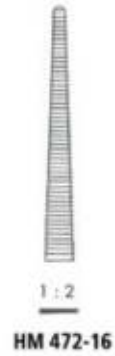
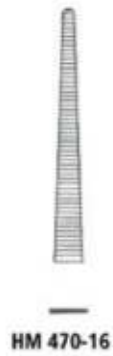
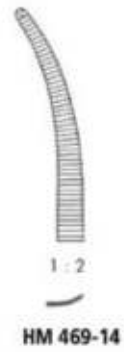
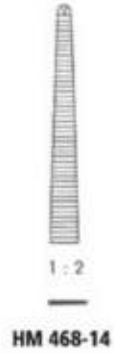
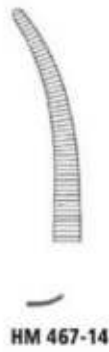

Hemostatik Pensler
Haemostatic Forceps
Arterienklemmen

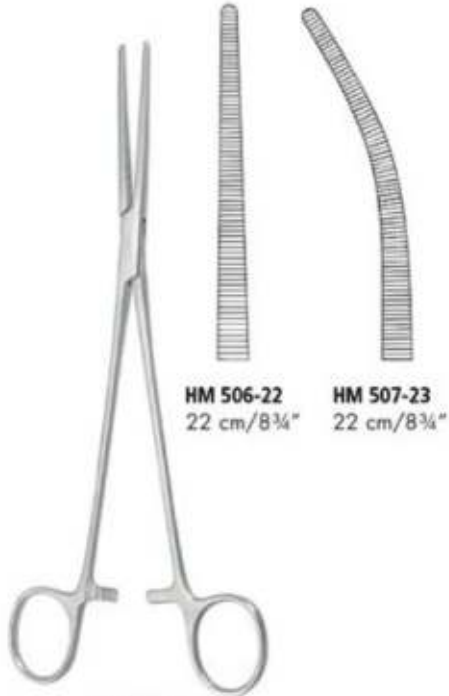

HM 506-22
 22 cm/8¾"

HM 507-23
 22 cm/8¾"

ROBERTS

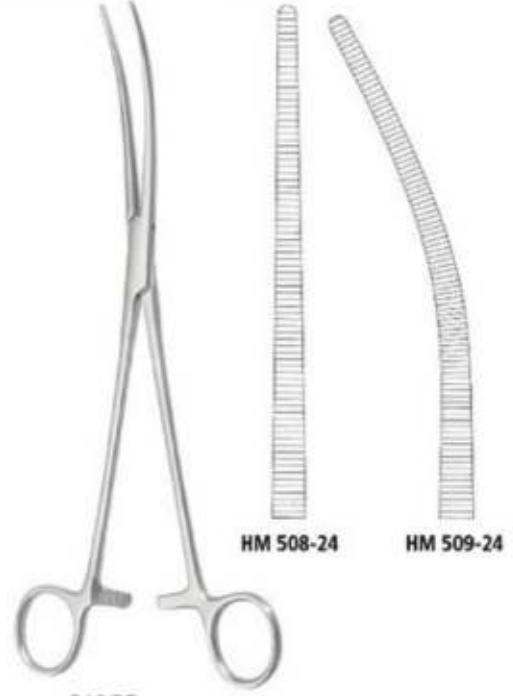

HM 508-24

HM 509-24

SAROT
 24 cm/9½"



HM 510-24
 24 cm/9½"

CRAFOORD



HM 515-01
 24 cm/9½"

HM 515-02
 24 cm/9½"

HM 515-03
 23,5 cm/9¼"

HM 515-04
 24 cm/9½"

RUMEL

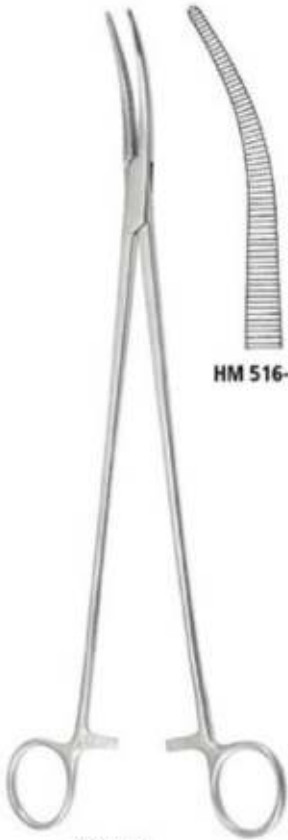

ZENKER
29,5 cm/12"



HM 516-29



HM 517-29



BRIDGE
28 cm/11"

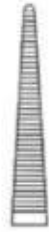

HM 526-28



HM 527-28



LAWRENCE
28 cm/11"



HM 531-28

Hemostatik Pensler
Haemostatic Forceps
Arterienklemmen



MIXTER-O'SHAUGNESSY
15,5 cm/6" **HM 521-15**
19,0 cm/7½" **HM 521-19**



MIXTER Baby
HM 522-18
18 cm/7"



Baby MIXTER
14 cm/5½"

HM 520-01

HM 520-02



MIXTER

HM 521-22
22 cm/8¾"

HM 521-25
25 cm/9¾"

HM 521-28
28 cm/11"



GEMINI



HM 532-14
13 cm/5"



HM 532-16
16 cm/6¼"



HM 532-18
18 cm/7"



HM 532-20
20 cm/8"

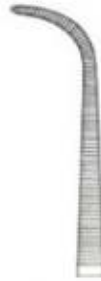

HM 532-23
23 cm/9"



HM 532-25
25 cm/10"



HM 532-28
28 cm/11"



LAHEY



HM 540-19
19 cm/7½"



HM 540-23
23 cm/9"



FINOCHIETTO
HM 542-24
24 cm/9½"

Tüp Klempleri
Tubing Clamps
Schlauchklemmen

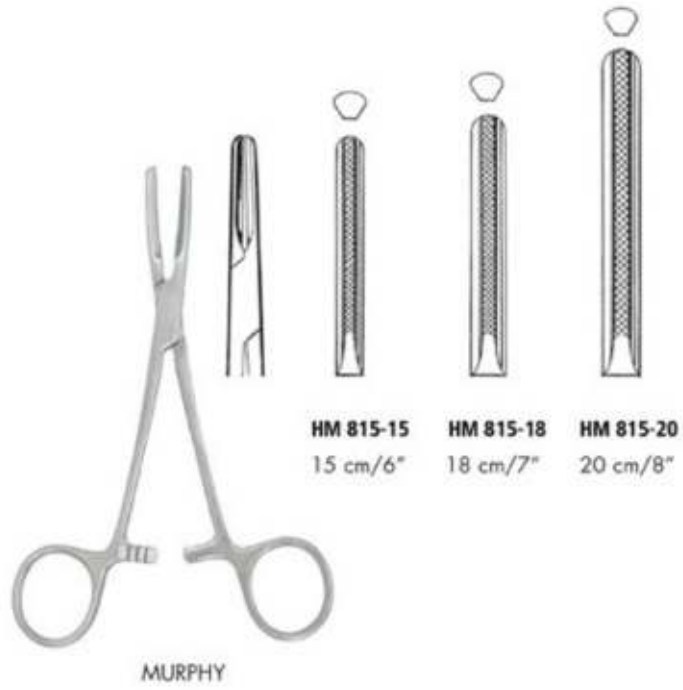



TOHOKU



HM 882-10
10 cm/4"

HM 882-13
13 cm/5"



PEERS BERTRAM
HM 883-14
14,5 cm/5¾"



PRESBYTERIAN HOSPITAL
16 cm/6¼" HM 810-16
18 cm/7" HM 810-18



BERLIN
HM 811-14
14,5 cm/5¾"



Çamasır Klempleri
Towel Clamps
Tuchklemmen



SCHAEDEL
HM 800-09
9 cm/3½"



JONES
5,5 cm/2¼" HM 820-05
8,5 cm/3¼" HM 820-09



LANE
15,5 cm/6" HM 840-15
19,5 cm/7¾" HM 840-20



BACKHAUS
9 cm/3½" HM 860-08
11 cm/4¼" HM 860-11
13 cm/5" HM 860-13
15 cm/6" HM 860-15



BALL AND SOCKET
HM 861-13
13 cm/5"



LORNA
10 cm/4" HM 881-10
13 cm/5" HM 881-13

Für die Vena cava
for Vena Cava
pour vena cava
de la vena cava
per la vena cava



Atravmatik Damar Klempleri
Non-traumatic Vessel Forceps
Atraumatische Gefäßklemmen

Buldogklemmen mit Ringgriff
 Ring Bulldog clamps

ATRAUMA



DE BAKEY

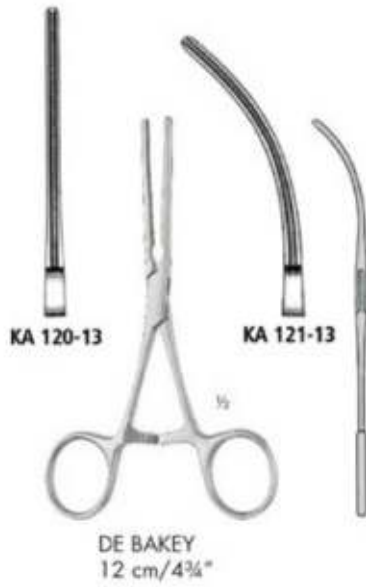

Neonatal- und Pädiatrischeklemmen, extra feine Modelle
Neonatal and Pediatric Clamps, extra delicate patterns

ATRAUMA



DE BAKEY



CASTAÑEDA
12 cm/4¾"



KA 125-30

KA 125-45



CASTAÑEDA
15,5 cm/6"



KA 126-15

KA 126-18

KA 126-23

KA 126-25

Atravmatik Damar Klempneri
Non-traumatic Vessel Forceps
Atraumatische Gefäßklemmen

Atraumatische Mehrzweckklemmen
Atraumatic Multi-Purpose Clamps

ATRAUMA



DE BAKEY



Aorta-Anastomosenklemmen
Aorta-Anastomosis Clamps

ATRAUMA



DE BAKEY



DERRA



KA 129-16
16 cm/6¼"



KA 129-20
17 cm/6¾"



KA 129-26
18 cm/7"



DE BAKEY
17 cm/6¾"



KA 130-16



DE BAKEY
20 cm/8"



KA 131-20

Atravmatik Damar Klempleri
Non-traumatic Vessel Forceps
Atraumatische Gefäßklemmen

ATRAUMA



DE BAKEY



HALSTEAD-MOSQUITO



KA 150-01
12 cm/4¾"



KA 150-02
12 cm/4¾"



KA 151-01
15 cm/6"



KA 151-02
15 cm/6"



BAINBRIDGE



KA 152-01
15 cm/6"



KA 153-01
18,5 cm/7¼"



KA 152-02
15 cm/6"



KA 153-02
18,5 cm/7¼"



ATRAUMA



DE BAKKEY

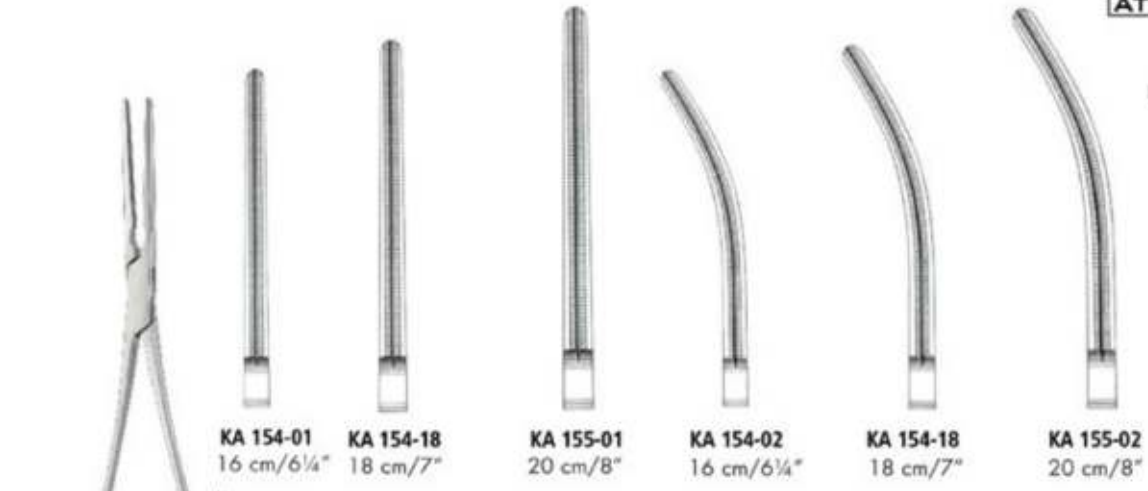

Präparien- und Ligaturklemmen
 Dissecting and Ligature Clamps



DE BAKKEY-MC QUIGG-MIXTER
KA 160-21
 21 cm/8¼"

Atravmatik Damar Klempleri
Non-traumatic Vessel Forceps
Atraumatische Gefäßklemmen

ATRAUMA



DE BAKEY



DE BAKEY

KA 162-19
19 cm/7½"

KA 162-23
23 cm/9"

KA 170-70
18 cm/7"

KA 170-95
22 cm/8¾"

KA 171-60



GLOVER

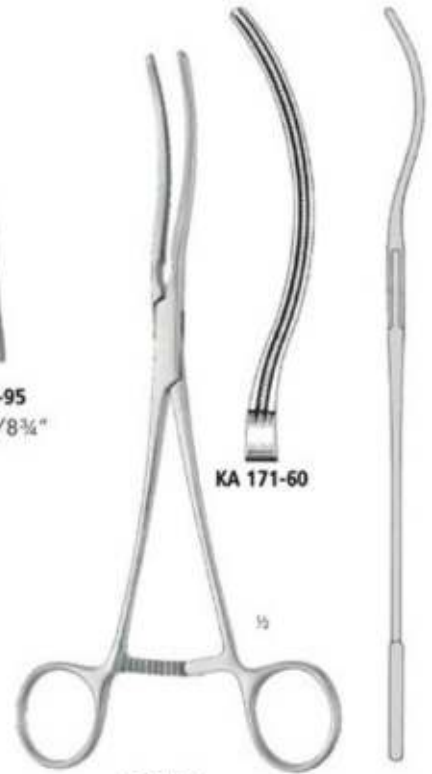

GLOVER
21 cm/8¼"

Aorta-Anastomosenklemmen
Aorta-Anastomosis Clamps



ATRAUMA



DE BAKEY

Aortaklemmen
Aortic Clamp



Atravmatik Damar Klempleri
Non-traumatic Vessel Forceps
Atraumatische Gefäßklemmen



Anastomosenklemmen
Anastomosis Clamps



KA 170-65
21 cm/8¼"

KA 170-86
24 cm/9½"

ATRAUMA



DE BAKEY
1875 - 1916



Atraumatische Mehrzweckklemmen
Atraumatic Multi-Purpose Clamps



KA 174-65
20,5 cm/8"

KA 174-45
21 cm/8¼"

Aurikelklemmen
Auricle Clamps



KA 175-01



KA 175-02

ATRAUMA



DE BAKEY



KA 175-03



KA 175-04



HARKEN
24 cm/9½"

Atravmatik Damar Klempleri
Non-traumatic Vessel Forceps
Atraumatische Gefäßklemmen

Atraumatische Mehrzweckklemmen
Atraumatic Multi-Purpose Clamps

ATRAUMA



DE BAKEY

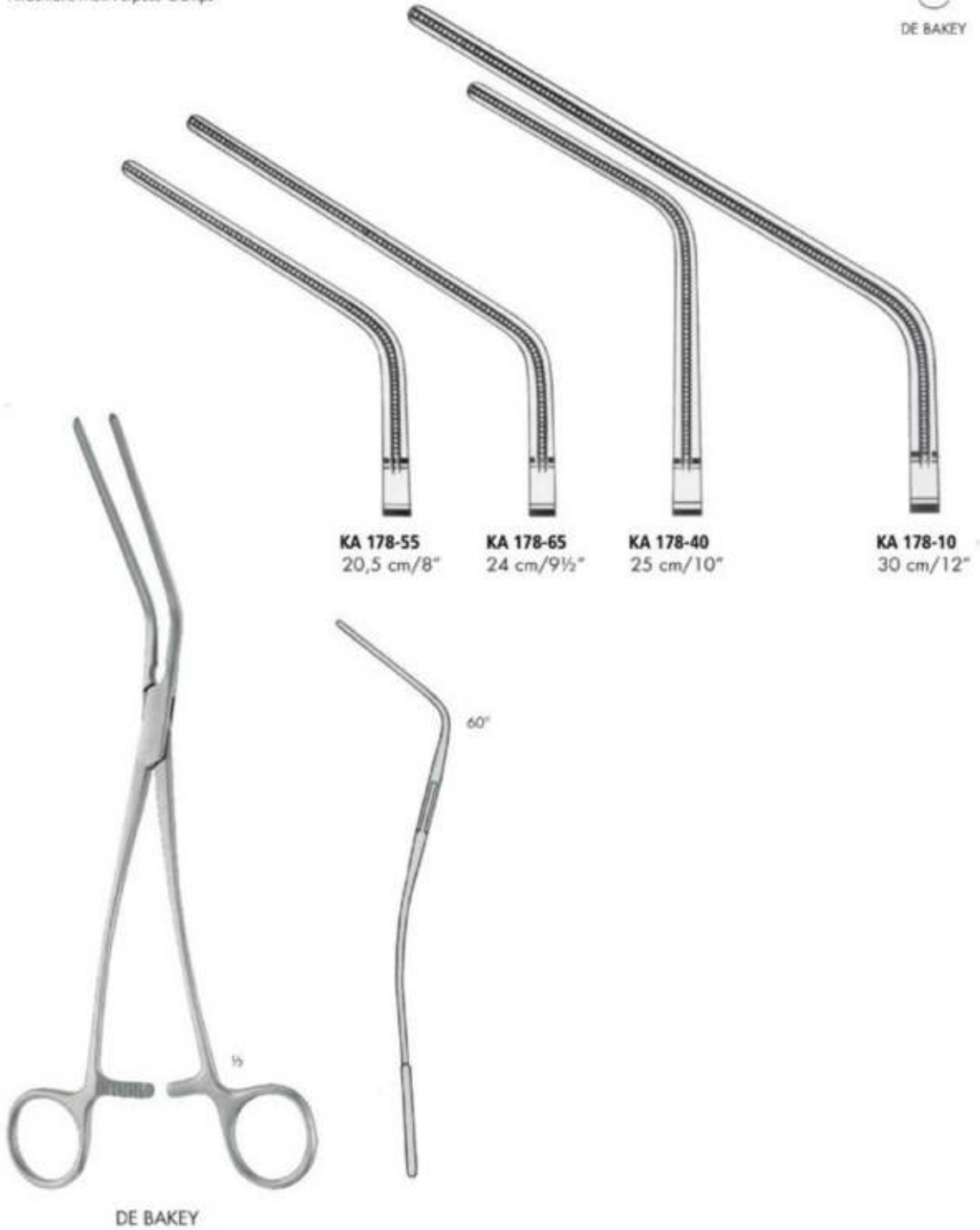

Atraumatische Mehrzweckklemmen
Atraumatic Multi-Purpose Clamps

ATRAUMA



DE BAKEY

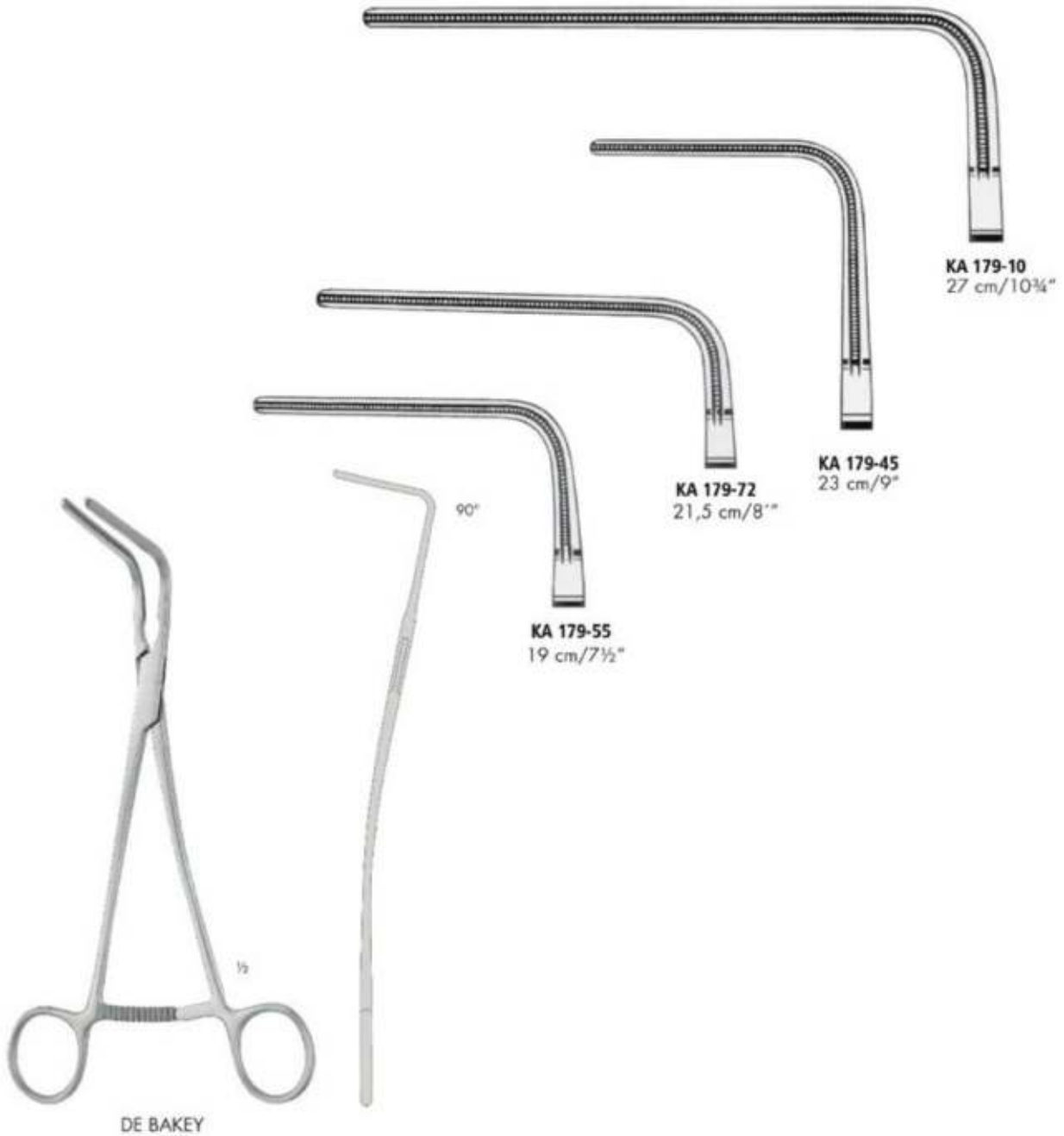

Atravmatik Damar Klempleri
Non-traumatic Vessel Forceps
Atraumatische Gefäßklemmen

idOL
CERRAHİ ALETLER
www.idolcerrahi.com

Tangentialklemmen
Tangential Occlusion Clamps

ATRAUMA

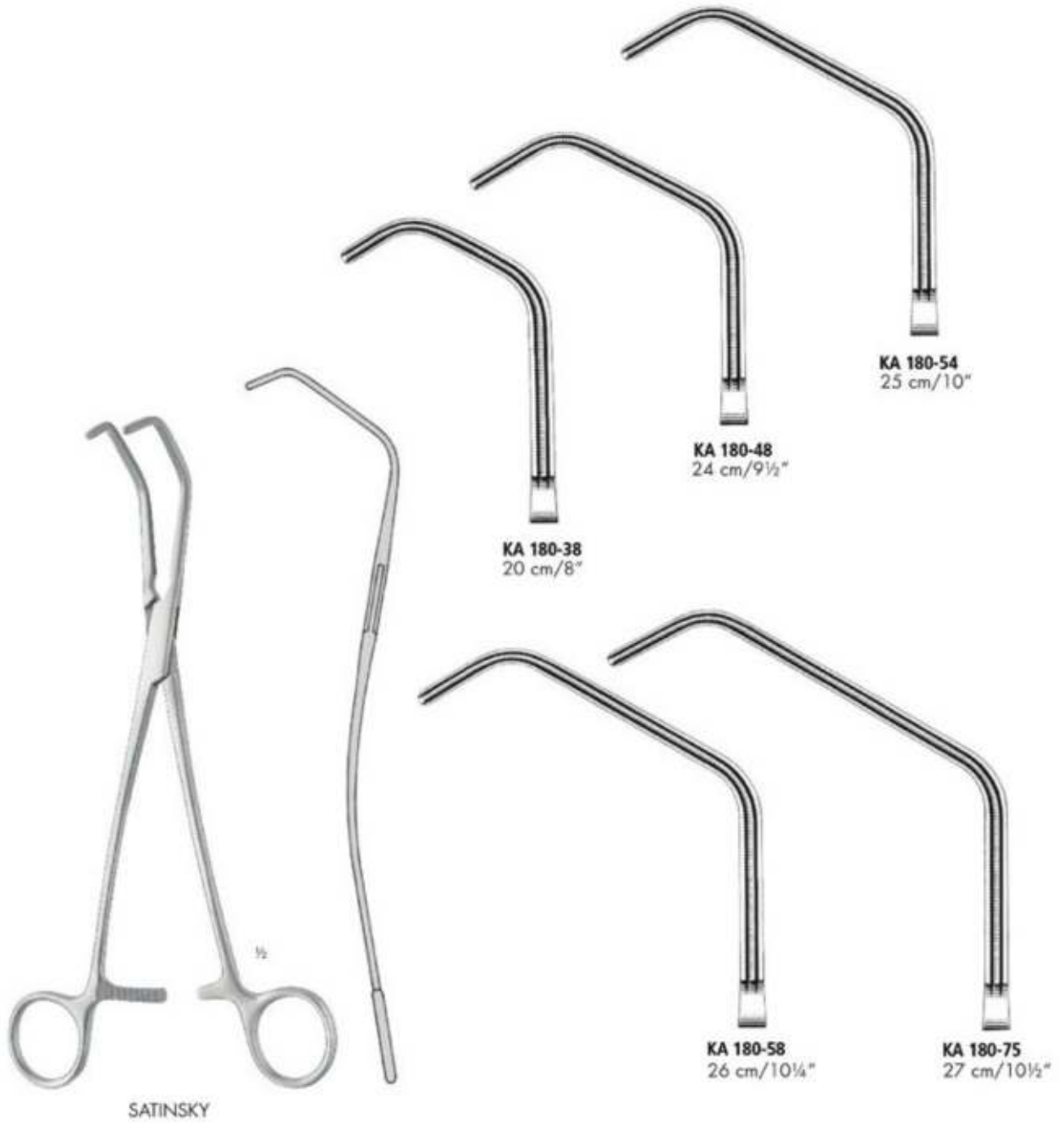

Tangentialklemmen
Tangential Occlusion Clamps

ATRAUMA



DE BAKEY



DE BAKEY-SATINSKY



KA 181-32
23 cm/9"

KA 181-40
24 cm/9½"

KA 181-47
25 cm/10"

Atravmatik Damar Klempleri
Non-traumatic Vessel Forceps
Atraumatische Gefäßklemmen

ATRAUMA



Coarctationsklemmen
Coarctation Clamps



POTTS



30 mm
KA 185-20
20 cm/8"



55 mm
KA 185-22
22,5 cm/8¾"



80 mm
KA 185-26
26 cm/10¼"



GLOVER



30 mm
KA 186-20
20 cm/8"



55 mm
KA 186-22
22,5 cm/8¾"



80 mm
KA 186-26
26 cm/10¼"

ATRAUMA



DE BAKEY



LELAND-JONES
KA 239-65
19 cm/7½"



Peripheal-Gefäßklemmen
Peripheal Vascular Clamps



Aortaklemmen
Aortic Clamp

OCHSNER



KA 240-50
26 cm/10¼"

Atravmatik Damar Klempleri
Non-traumatic Vessel Forceps
Atraumatische Gefäßklemmen

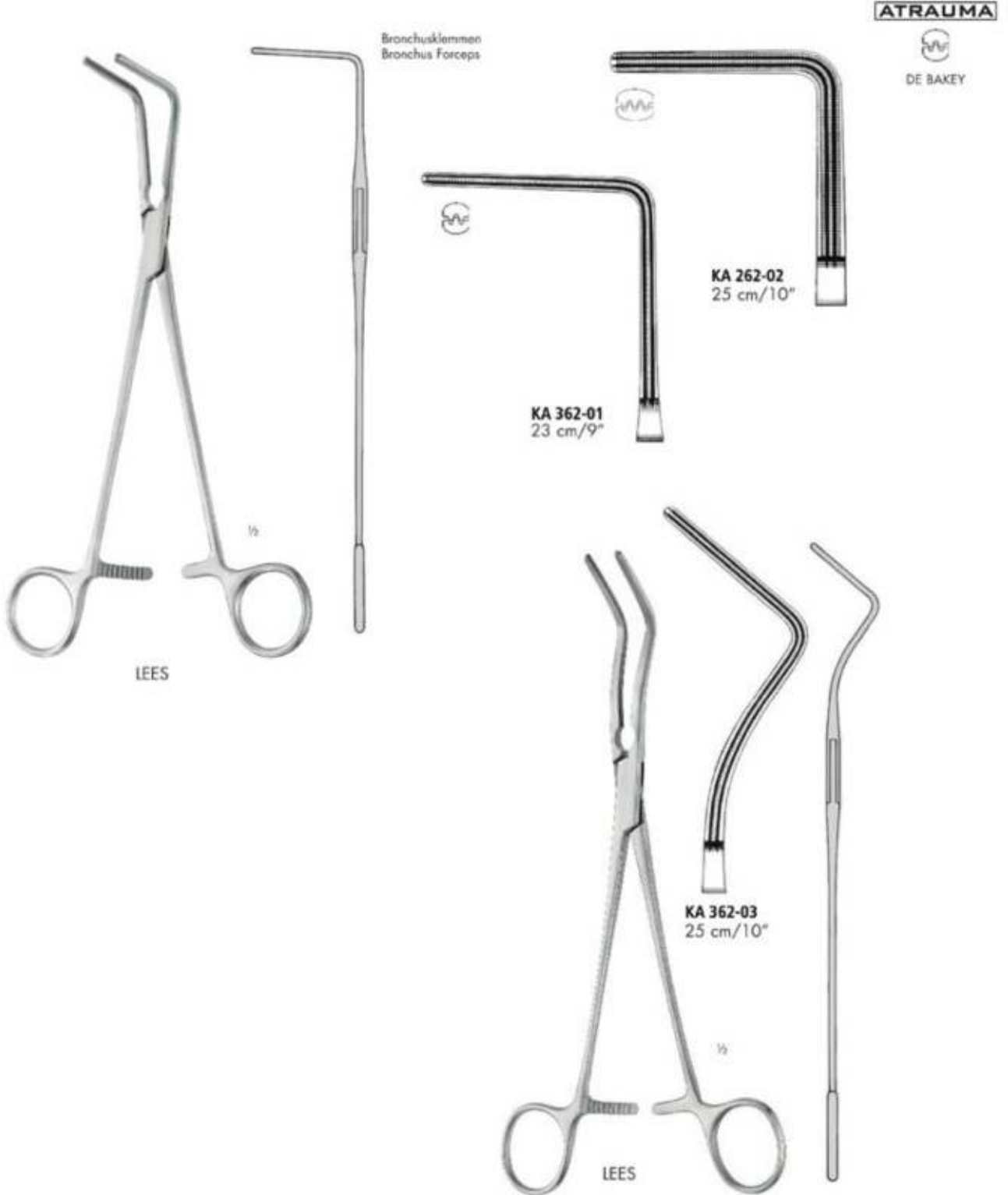

Aorta Aneurysma-Klemmen
Aorto-Aneurysm Clamps

ATRAUMA



DE BAKEY



DE BAKEY-SEMB



KA 365-26
25 cm/10"



KA 365-27
26 cm/10¼"

Atravmatik Damar Klempleri
Non-traumatic Vessel Forceps
Atraumatische Gefäßklemmen

Aorta-Aneurysma-Klemmen
Aorta-Aneurysm Clamps

ATRAUMA



DE BAKEY



Aortaklemmen
Aortic Clamp

ATRAUMA



DE BAKEY



links gebogen
curved to left



rechts gebogen
curved to right



WEBER
KA 369-01
26 cm/10¼"



WEBER
KA 369-02
26 cm/10¼"

Atravmatik Damar Klempleri
Non-traumatic Vessel Forceps
Atraumatische Gefäßklemmen

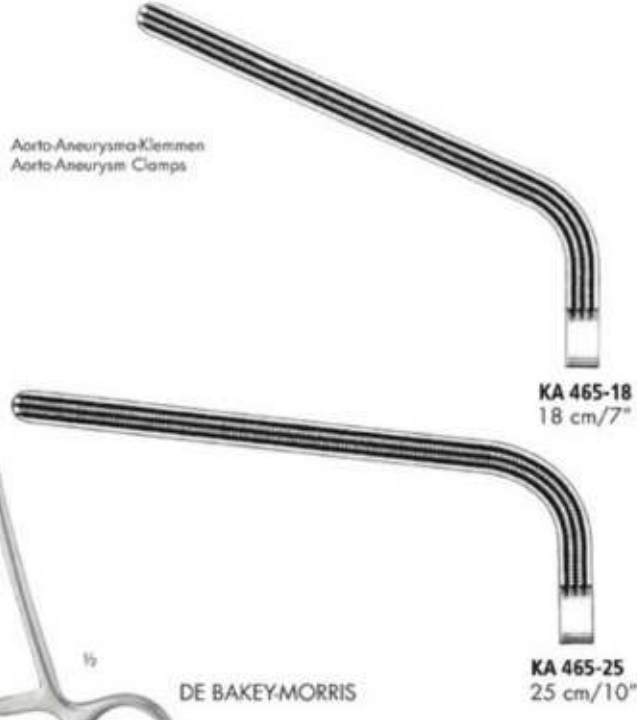

ATRAUMA



COOLEY

Bulldogklemmen mit Ringgriff
Ring Bulldog clamps

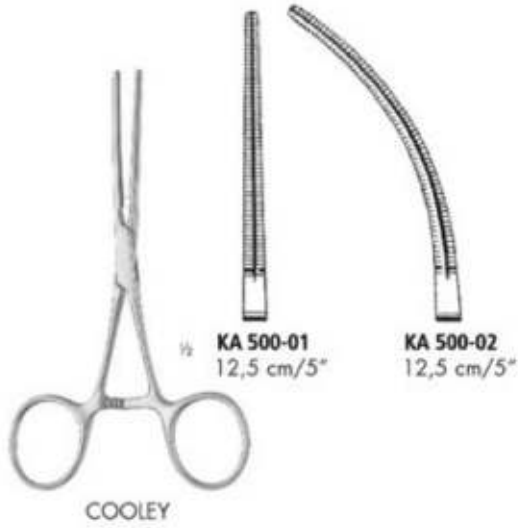

Atravmatik Damar Klempleri
Non-traumatic Vessel Forceps
Atraumatische Gefäßklemmen

Bulldogklemmen mit Ringgriff
Ring Bulldog clamps

ATRAUMA

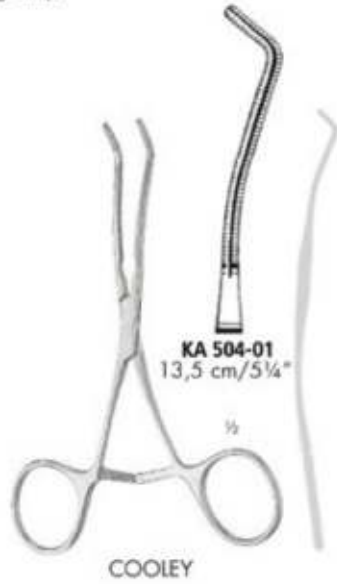

Anastomoseklemmen
Anastomosis Clamps



Anastomosenklemmen
Anastomosis Clamps

ATRAUMA



COOLEY



Atravmatik Damar Klempleri
Non-traumatic Vessel Forceps
Atraumatische Gefäßklemmen

Atraumatische Mehrzweckklemmen
 Atraumatic Multi-Purpose Clamps

ATRAUMA



COOLEY



Carotis-Shuntklemmen
 Carotid Shunt Clamps





KA 700-00	complete	C	D
		70 mm	64 mm



KA 700-01
10 mm 10 mm



KA 700-02
10 mm 15 mm



KA 700-03
10 mm 20 mm



KA 700-04
15 mm 20 mm



KA 700-05
20 mm 20 mm

Göğüs Ekartörleri
Rib Spreaders
Rippensperrer



FINOCHIETTO-BABY

	A	B	C	D
KA 701-75	14 mm	15 mm	75 mm	55 mm



HERTZLER

	A	B	C	D
KA 702-90	20 mm	25 mm	105 mm	90 mm



½

TUFFIER

	A	B	C	D
KA 703-17	50 mm	45 mm	165 mm	110 mm



½

TUFFIER

	A	B	C	D
KA 703-90	32 mm	19 mm	145 mm	90 mm

Göğüs Ekartörleri
Rib Spreaders
Rippensperrer



	A	B	C	D
KA 705-90	30 mm	30 mm	115 mm	90 mm

½

HAIGHT



	A	B	C	D
KA 707-14	28 mm	32 mm	120 mm	140 mm

½



FINOCHIETTO

	A	B	C	D
KA 708-17	40 mm	40 mm	165 mm	110 mm



FINOCHIETTO

	A	B	C	D
KA 708-20	45 mm	65 mm	210 mm	200 mm
KA 708-22	65 mm	65 mm	210 mm	220 mm

Göğüs Ekartörleri
Rib Spreaders
Rippensperrer



KA 715-01
25,5 mm 80 mm



KA 715-02
30 mm 80 mm



KA 715-03
40 mm 67 mm



KA 715-04
80 mm 67 mm



FINOCHIETTO BURFORD

	C	D
KA 715-00	220 mm	220 mm



KA 720-01
30 mm 30 mm



KA 720-02
40 mm 40 mm



KA 720-03
50 mm 50 mm



KA 720-04
66 mm 66 mm

	C	D
KA 720-00	150 mm	180 mm



½
DE BAKEY

Göğüs Ekartörleri
Rib Spreaders
Rippensperrer



KA 721-01
40 mm 100 mm



KA 721-02
50 mm 66 mm

	C	D
KA 721-00	200 mm	225 mm



KA 721-03
50 mm 80 mm



KA 721-04
60 mm 60 mm



KA 721-05
80 mm 60 mm



MORSE

	A	B	C	D
KA 725-00	12 mm	20 mm	200 mm	150 mm
KA 726-00	20 mm	20 mm	200 mm	195 mm

Sternum Ekartörleri
Sternotomy-Spreaders
Sternotomie-Sperrer

iDOL
CERRAHİ ALETLER
www.idolcerrahi.com



	A	B	C	D
KA 730-00	22 mm	45 mm	150 mm	145 mm
KA 731-00	34 mm	51 mm	200 mm	180 mm



COOLEY



MERCEDES
KA 750-00



KA 750-01
48 mm 68 mm



KA 750-02
70 mm 75 mm

I.M.A. Ekartör
I.M.A. Retractor
IMA-Spreizer

idOL
CERRAHİ ALETLER
www.idolcerrahi.com



EK 760-00
Mammario Sperrer
mammaria retractors

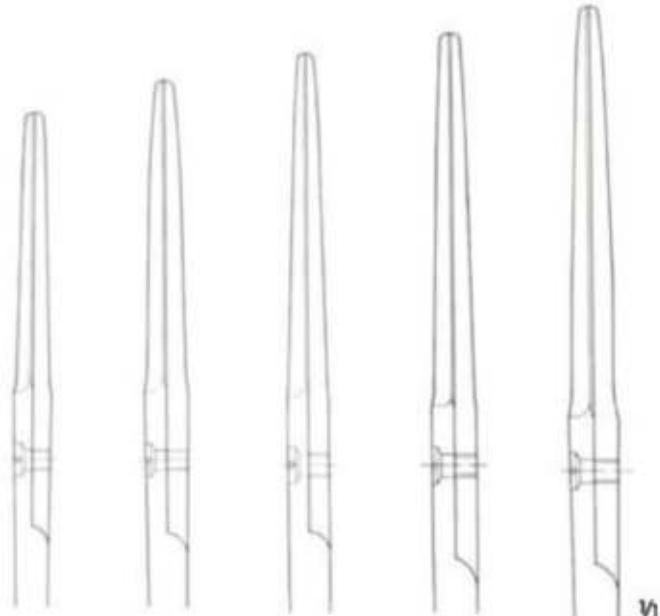

MA 100-13 13 cm **MA 100-14** 14.5 cm **MA 100-15** 15 cm **MA 100-16** 16.5 cm **MA 100-17** 17.5 cm

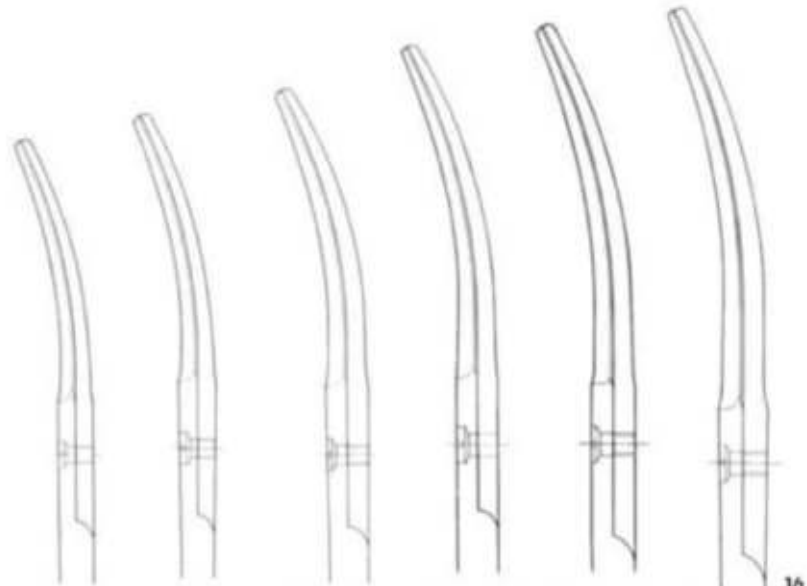

MA 101-11 11.5 cm **MA 101-13** 13 cm **MA 101-14** 14.5 cm **MA 101-15** 15 cm **MA 101-16** 16.5 cm **MA 101-17** 17.5 cm

Cerrahi Makaslar
Surgical Scissors
Chirurgische Scheren

iDOL
CERRAHI ALETLER
www.idolcerrahi.com





Vi

MA 104-11
11,5 cm

MA 104-13
13 cm

MA 104-14
14,5 cm

MA 104-15
15 cm

MA 104-16
16,5 cm



Vi

MA 105-11
11,5 cm

MA 105-13
13 cm

MA 105-14
14,5 cm

MA 105-15
15 cm

Diseksiyon Makasları
Dissecting Scissors
Präparierscheren

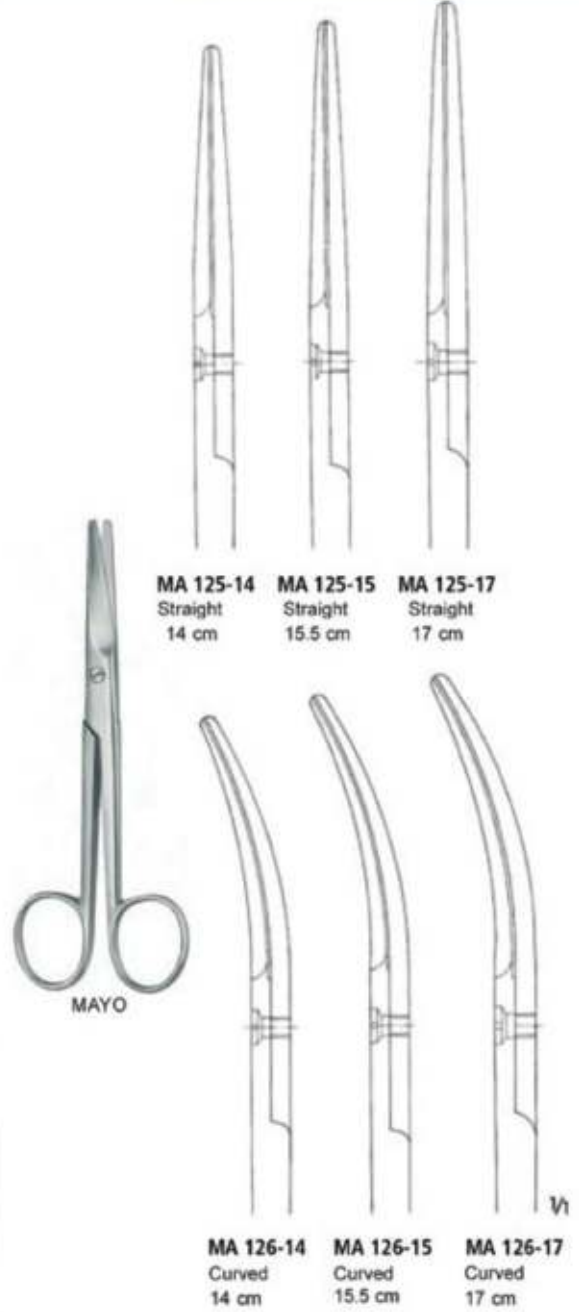
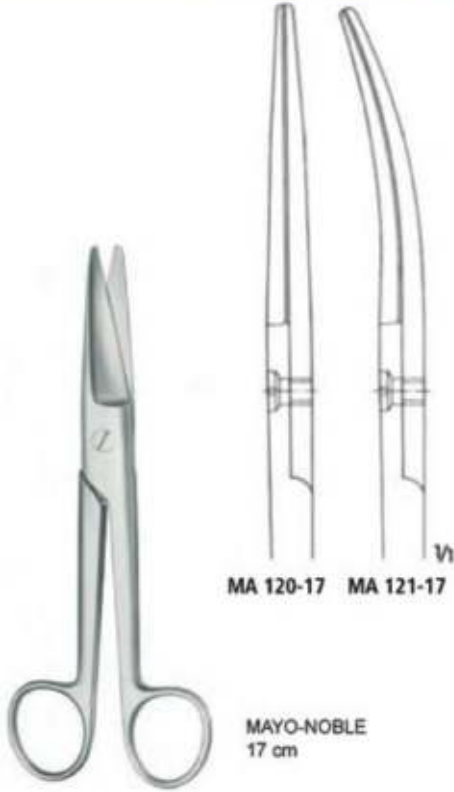



METZENBAUM

MA 149-14
Straight
14.5 cm

MA 214-18
Straight
18 cm

MA 214-20
Straight
20 cm

MA 150-14
Curved
14.5 cm

MA 215-18
Curved
18 cm

MA 215-20
Curved
20 cm



MA 219-15
Curved
15 cm



JOSEPH
15 cm

MA 228-14
Straight/Sharp

MA 229-14
Curved/Sharp

Damar Makasları
Vessel Scissors
Gefäßscheren



POTTS-SMITH

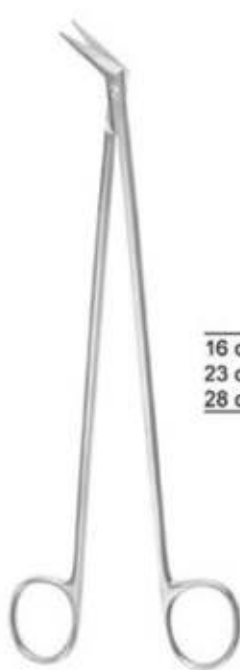
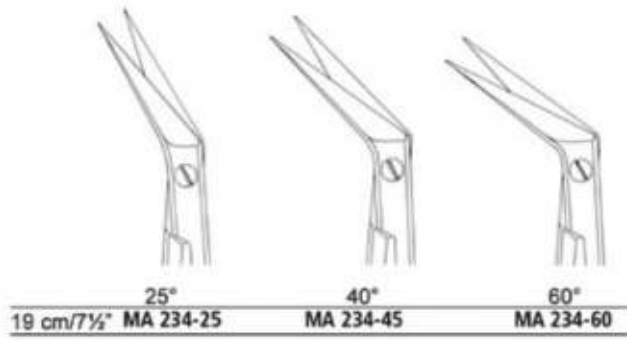

DE BAKEY

